

Rebar and earthing foundation clamp

Cat. no.
11700302

To connect tape conductors with reinforcing bars at foundation earthing and in reinforced concrete columns. Black steel or hot-dip galvanized options.

Type
117.3

Material
(St/tZn) hot galvanized steel

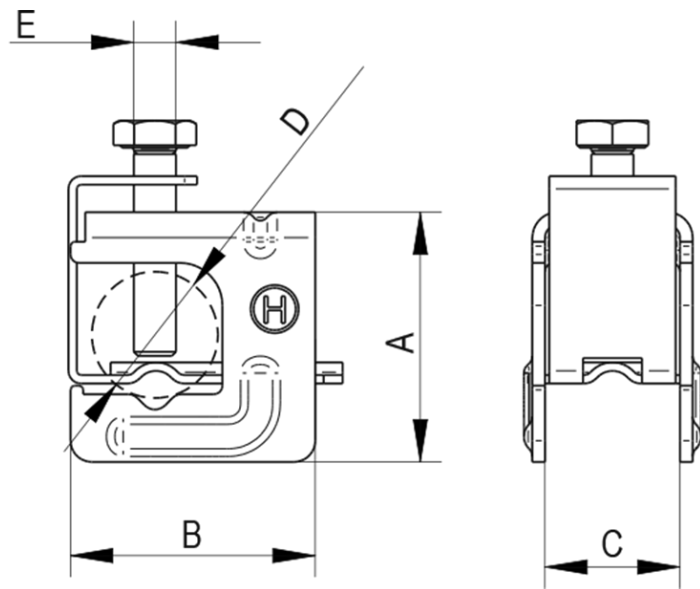
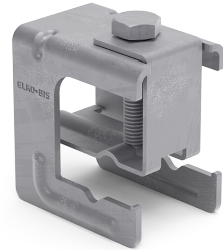

TYP	A	B	C	D	E	TAPE CONDUCTOR	NOTES
117.3	73	69	42	Ø38	M10×50	MAX 40×5	with holdfast plate

