

en **Owners Guide**

Schneider StarCharge Fast 720 Power Cabinet
Schneider StarCharge Fast 720 Dispenser

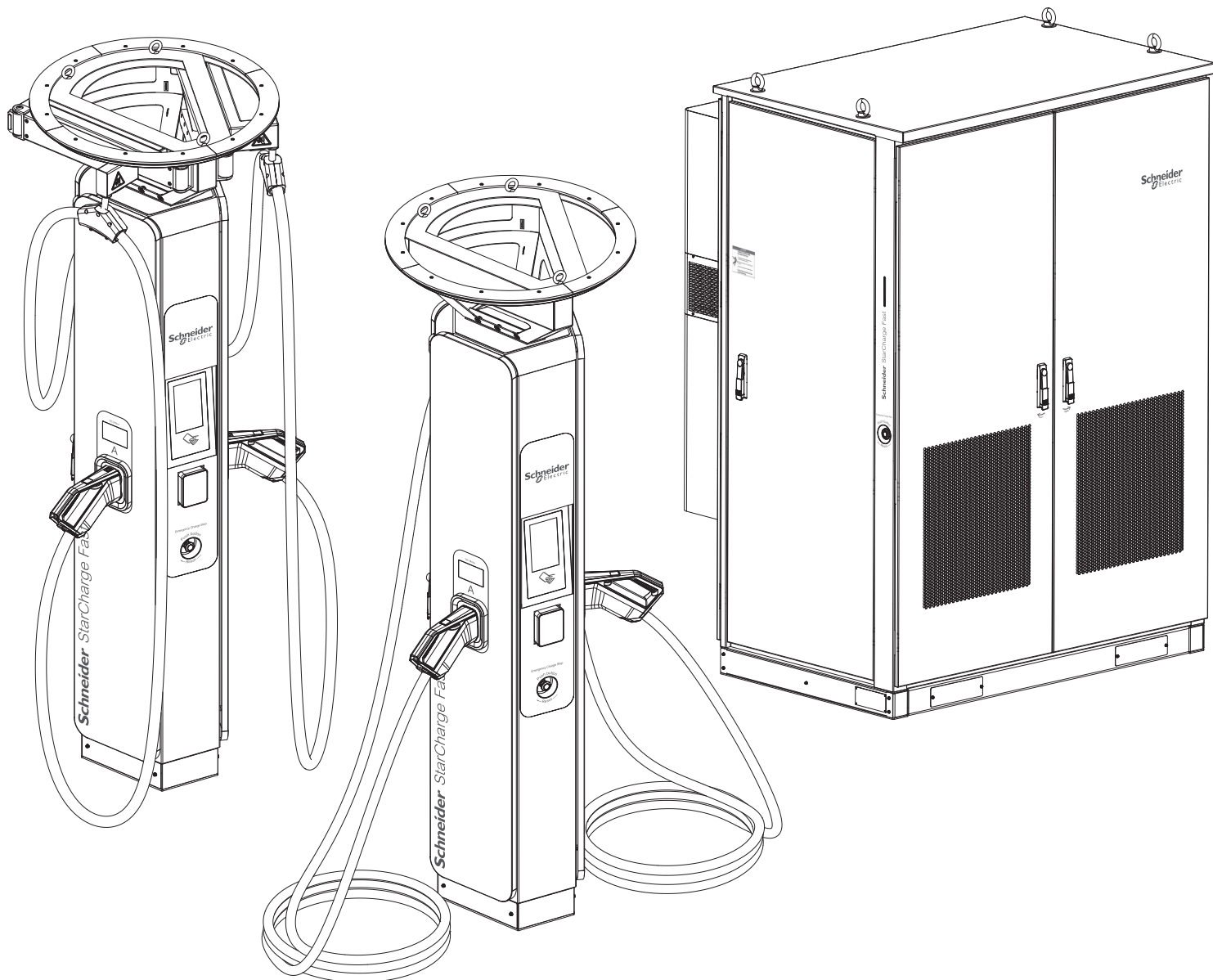

Customer Care Center

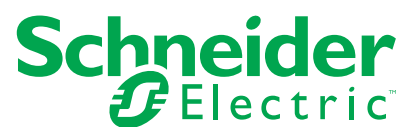
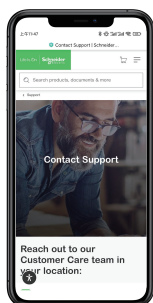

| | |
|---|-----------|
| General | 3 |
| Preface | 4 |
| 1. System Overview | 5 |
| 1.1 Charging Stations Configurations..... | 8 |
| 1.2 Authentication Modes..... | 8 |
| 1.3 Payment Methods..... | 9 |
| 1.4 LED Status Indicator..... | 9 |
| 1.5 Languages..... | 10 |
| 1.6 Tariff..... | 11 |
| 1.7 Charger Information..... | 11 |
| 1.8 Service Information..... | 11 |
| 1.9 Charge Session DC Meter Reading..... | 12 |
| 2. User Instructions | 13 |
| 2.1 Basic Charging Steps | 13 |
| 2.2 Charging Authentication Modes | 13 |
| 3. Consumption Statistics | 17 |
| 3.1 Charging Session Statistics..... | 17 |
| 3.2 Charge Session Report..... | 17 |
| 3.3 Screen saver and logo change..... | 17 |
| 4. Preventive Maintenance | 18 |
| Regular Maintenance | 18 |
| 5. Recycle | 19 |

Legal Information



The information provided in this document contains general descriptions, technical characteristics and/or recommendations related to products/solutions.

This document is not intended as a substitute for a detailed study or operational and site-specific development or schematic plan. It is not to be used for determining suitability or reliability of the products/solutions for specific user applications. It is the duty of any such user to perform or have any professional expert of its choice (integrator, specifier or the like) perform the appropriate and comprehensive risk analysis, evaluation and testing of the products/solutions with respect to the relevant specific application or use thereof.

The Schneider Electric brand and any trademarks of Schneider Electric SE and its subsidiaries referred to in this document are the property of Schneider Electric SE or its subsidiaries. All other brands may be trademarks of their respective owner.

This document and its content are protected under applicable copy right laws and provided for informative use only. No part of this document may be reproduced or transmitted in any form or by any means (electronic, mechanical, photocopying, recording, or otherwise), for any purpose, without the prior written permission of Schneider Electric.

Schneider Electric does not grant any right or license for commercial use of the document or its content, except for a non-exclusive and personal license to consult it on an "as is" basis.

Schneider Electric reserves the right to make changes or updates with respect to or in the content of this document or the format thereof, at any time without notice.

To the extent permitted by applicable law, no responsibility or liability is assumed by Schneider Electric and its subsidiaries for any errors or omissions in the informational content of this document, as well as any non-intended use or misuse of the content thereof.

Electrical equipment should be installed, operated, serviced, and maintained only by qualified personnel. No responsibility is assumed by Schneider Electric for any consequences arising out of the use of this material.

General

Warning Symbols Definitions

The following safety messages may appear throughout this manual or on the equipment to warn of potential hazards or to call attention to information that clarifies or simplifies a procedure.



The addition of this symbol to a "Danger" or "Warning" safety message indicates that an electrical hazard exists which will result in personal injury if the instructions are not followed.



This is the safety alert symbol. It is used to alert you to potential personal injury hazards. Obey all safety messages with this symbol to avoid possible injury or death.

⚠ DANGER

DANGER indicates a hazardous situation which, if not avoided, **will result in death or serious injury.**
Failure to follow these instructions will result in death or serious injury.

⚠ WARNING

WARNING indicates a hazardous situation which, if not avoided, **could result in death or serious injury.**
Failure to follow these instructions can result in death, serious injury, or equipment damage.

⚠ CAUTION

CAUTION indicates a hazardous situation which, if not avoided, **could result in minor or moderate injury.**
Failure to follow these instructions can result in injury or equipment damage.

NOTICE

NOTICE is used to address practices not related to physical injury. The safety alert symbol shall not be used with this type of safety message.
Failure to follow these instructions can result in equipment damage.

Safety Instructions

⚠ ⚠ DANGER

HAZARD OF ELECTRICAL SHOCK, EXPLOSION OR ARC FLASH

- Read and follow all warnings and instructions before installing and operating the Schneider StarCharge Fast Charging Station. Install and operate only as instructed. Failure to do so may lead to death, injury, or property damage, and will void the Limited Warranty.
- The product must be installed according to the specifications and requirements as defined by Schneider Electric. No responsibility is assumed by Schneider Electric if these requirements are not respected.
- Always inspect the Charging Station for proper installation before use.
- Always ground the Schneider StarCharge Fast Charging Station. Failure to ground the charging station can lead to risk of electrocution or fire. The charging station must be connected to a grounded, metal, permanent wiring system, or an equipment grounding conductor shall be run with circuit conductors and connected to the equipment grounding terminal.
- Install the Schneider StarCharge Fast Charging Station on a concrete pad according to the Schneider Electric approved method. Failure to install on a surface that can support the full weight of the charging station can result in death, personal injury, or property damage.
- This charging station is not suitable for use in or around hazardous locations, such as near flammable, explosive, or combustible materials.
- Do not install the Schneider StarCharge Fast Charging Station until all construction work has been completed and the installation area has been cleared & cleaned.
- Do not use this product if the enclosure, Electric vehicle cable, or the Electric vehicle connector is broken, cracked, open, or shows any other indication of damage.
- Do not put fingers into the electric vehicle connector.

Failure to follow these instructions will result in death or serious injury.

⚠ CAUTION

HAZARD OF DEGRADATION OF EQUIPMENT PERFORMANCE

- Under no circumstances will compliance with the information in this manual relieve the user of his/her responsibility to comply with all applicable codes or safety standards.
- Schneider Electric is not responsible for any damages that may result from custom installations that are not described in this document or for any failure to adhere to installation recommendations.

Failure to follow these instructions can result in injury or equipment damage.

NOTICE

RISK OF DAMAGING

- Before installing the Schneider StarCharge Fast Charging Station, consult with a licensed contractor, such as a licensed electrician, and use a trained installation expert to ensure compliance with local building and electrical codes and standards, climate conditions, safety standards, and all applicable codes and ordinances.
- A qualified person is one who has the skills and knowledge related to the construction, installation and operation of electrical equipment and has received safety training to recognize and avoid the hazards involved.

Failure to follow these instructions can result in equipment damage.

Preface

This guide describes the operation and maintenance of the Schneider StarCharge Fast 720 Charging Stations. The Schneider StarCharge Fast Charging Stations are easy to install DC fast Charging Stations for electric vehicles. Fast Charging Stations are electrical installations with high electric currents. Therefore, any maintenance must be planned carefully, and must be done by certified personnel only (according to local standards).

Document Application

This document serves:
Site operators responsible for the charger's operation on site, performing regular inspection and maintenance activities and who are able to perform simple maintenance activities.
The Electric Vehicle drivers who will mainly use the icons and texts on the HMI display of the charger.
However, the user interface design facilitates the user experience & it is easy to use the Charging station by following the instructions on the HMI screen.

Available Documentation

Schneider StarCharge Fast 720 available documents for each phase of the project:

| Document | Reference | Content | Audiences |
|--|--------------|---|--|
| Schneider StarCharge Fast 720 Datasheet | 998-24285450 | Full Power Cabinet specifications | Site designer, installer, and station operator |
| Schneider StarCharge Fast 720 Power Cabinet Installation Guide | JPS6871301 | Civil, mechanical, and electrical installation guidelines | Site engineer or installer/contractor |
| Schneider StarCharge Fast 720 Dispenser Installation Guide | JPS7899601 | Civil, mechanical, and electrical installation guidelines | Site engineer or installer/contractor |
| Schneider StarCharge Fast 720 Owners Guide | D3998049 | Operation and maintenance guidelines | Site operator and end user |
| Schneider StarCharge Fast 720 Commissioning Guide | D3998054 | Electrical and Communication guidelines | Site engineer or installer/contractor/station operator |
| Schneider StarCharge Fast 720 OCPP Guide | D3999127 | Integration rule of charger for Charge Point Operator | Charge Point Operator/Contractor |
| Schneider StarCharge Fast 720 Cybersecurity Guide | D3999124 | Cybersecurity rules and guidelines | Charge Point Operator/Contractor |

Owner Responsibilities

The owner and/or site operator are required:

- To ensure the site where the Charging Station will be installed, is in accordance with the requirements described in the Installation guide.
- To ensure enough space around the Charging Station to carry out maintenance work.
- To ensure all protection devices are correctly installed after carrying out installation or maintenance.
- To operate the Charging Station with the protection devices installed.
- To write an emergency plan that instructs users what to do in case of emergency.
- To appoint a person responsible for the safe operation of the charge station and for the coordination of all work. This person should be properly trained by Schneider Electric.
- To contact Schneider Electric Services for the periodic maintenance of the Charging Station at least once a year if not subscribed to a service plan.

Charge Point Operator Responsibilities

- A temporary buffer storage is available in the charging station, e.g. to temporarily store data package during a connection break. In general, the backend is responsible for the permanent storage of the data package in accordance with the Charge Point Operator, and the end customers will be able to access the charging data stored from the backend. The different operators with their owned backend will be informed of these requirements for complying.
- To start using Schneider StarCharge Fast 720 payment terminal, Charge Point Operator must proceed with the registration and activation of the payment terminal on the Payter or PAX cloud platform. The commissioning of the Schneider StarCharge Fast 720 payment terminal in Charge Point Operator's environment including the registration and activation of the payment terminal is required to enable Charge Point Operator to process payment transactions of EV drivers at the charging stations operated by the Charge Point Operator.

Payter or PAX cloud platform interfaces the payment terminals with each of the CSMS software operated by the Charge Point Operator, and the payment service providers' respective payment processing platforms. Schneider Electric does not intervene and does not bear any responsibility in the registration and activation of the payment terminals, nor in the interfacing of the payment terminals with any third-party solution.

Charge Point Operator shall have to enter into its own and separate agreements under its own responsibility with Payter or PAX to define the terms and conditions under which:

- The Payter or PAX payment terminal will be enrolled and activated on the Payter or PAX cloud platform accessed by the Charge Point Operator.
- In case of Defects in the payment terminals, Payter or PAX shall provide directly to the Charge Point Operator the support and maintenance of the payment terminals, including the direct supply by Payter or PAX to the Charge Point Operator of the payment terminals and their spare parts that the Charge Point Operator will assemble (or have their subcontractors assemble) into the Schneider StarCharge Fast 720 to replace the defective parts of the Payter or PAX payment terminals.
- For the PAX payment terminal, if the customer wants the terminal to connect to the cloud platform via its own 4G network instead of the internal modem of the Schneider StarCharge Fast 720, a 4G SIM card must be provided by the customer.

Please find below link for Payter payment terminal:
Registration of Payter Payment terminal:
<https://www.payter.com/registration>
Technical documentation related to the Payter Payment terminal:
<https://www.payter.com/downloads>

Please find below link for PAX payment terminal:
All registration and technical documents related to PAX Payment terminal:
<https://www.pax.com.cn/>

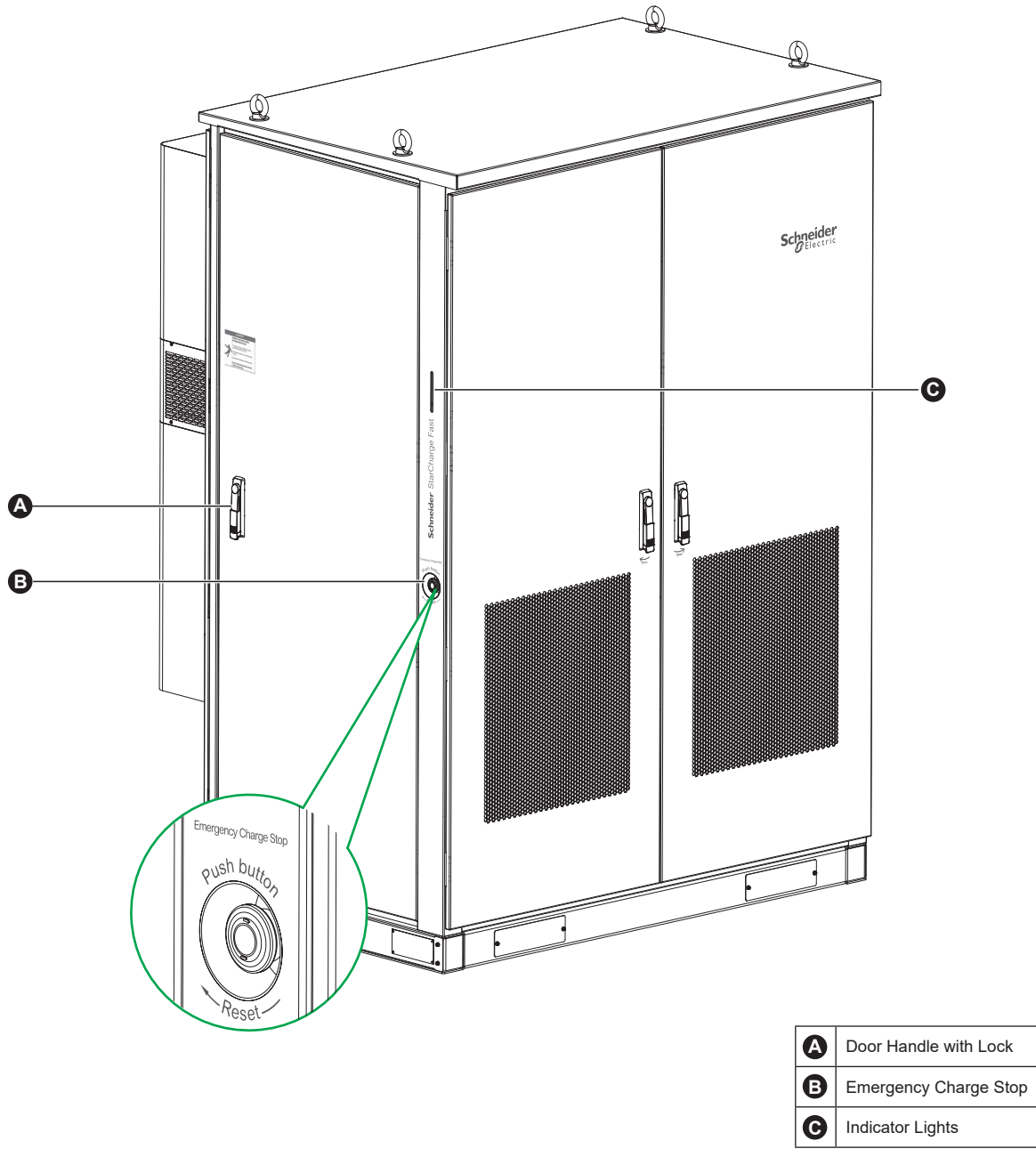

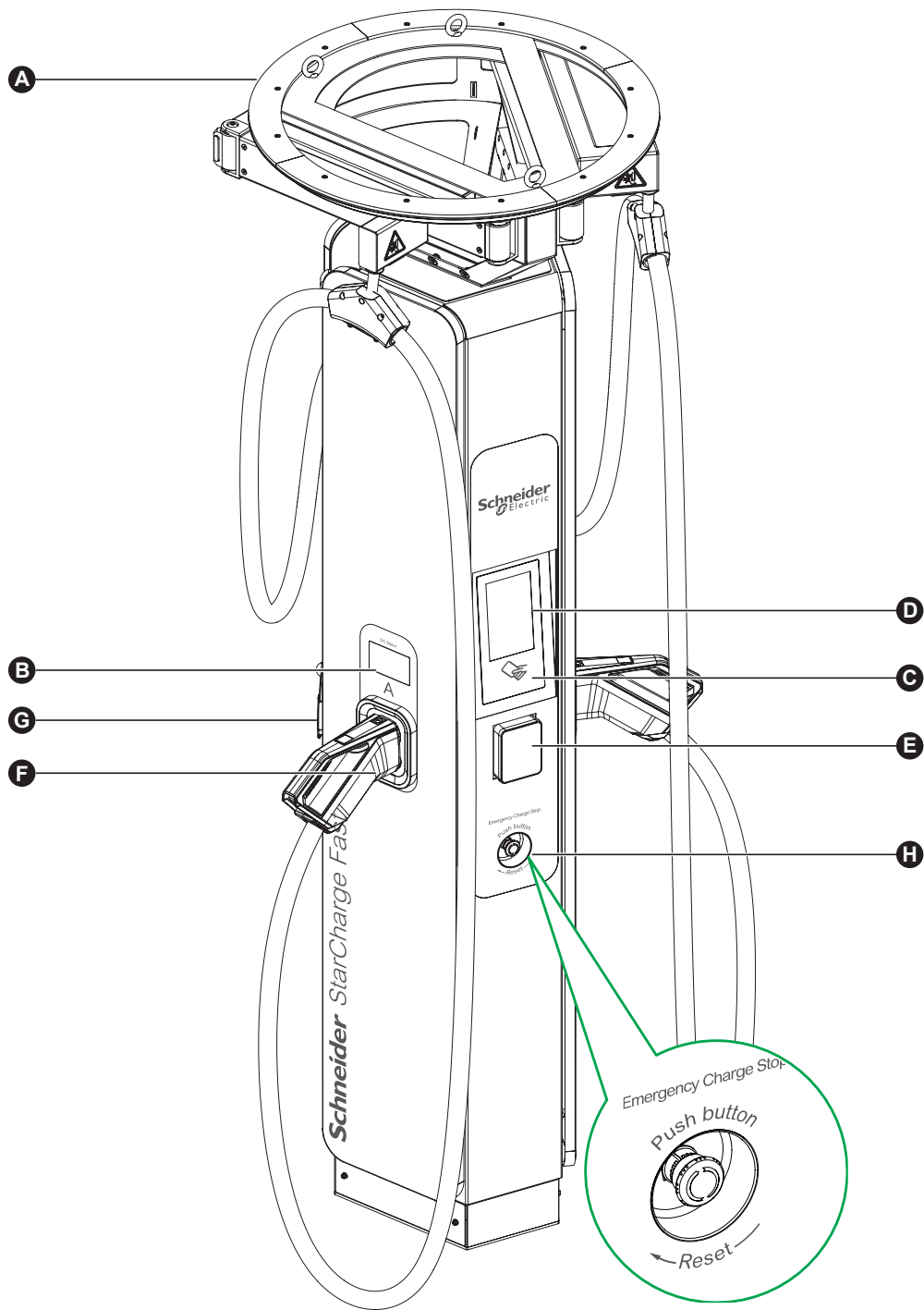

| | |
|----------|------------------------|
| A | Indicator Lights |
| B | Dc Energy Meter |
| C | Card Tapping Area |
| D | Touch Screen |
| E | Credit Card Reader |
| F | Vehicle Connector Slot |
| G | Door Handle with Lock |
| H | Emergency Charge Stop |

Image showing version equipped with cable management system and credit card reader.

Wiring diagram (taking 720kW Power Cabinet and copper conductor cable as an example):

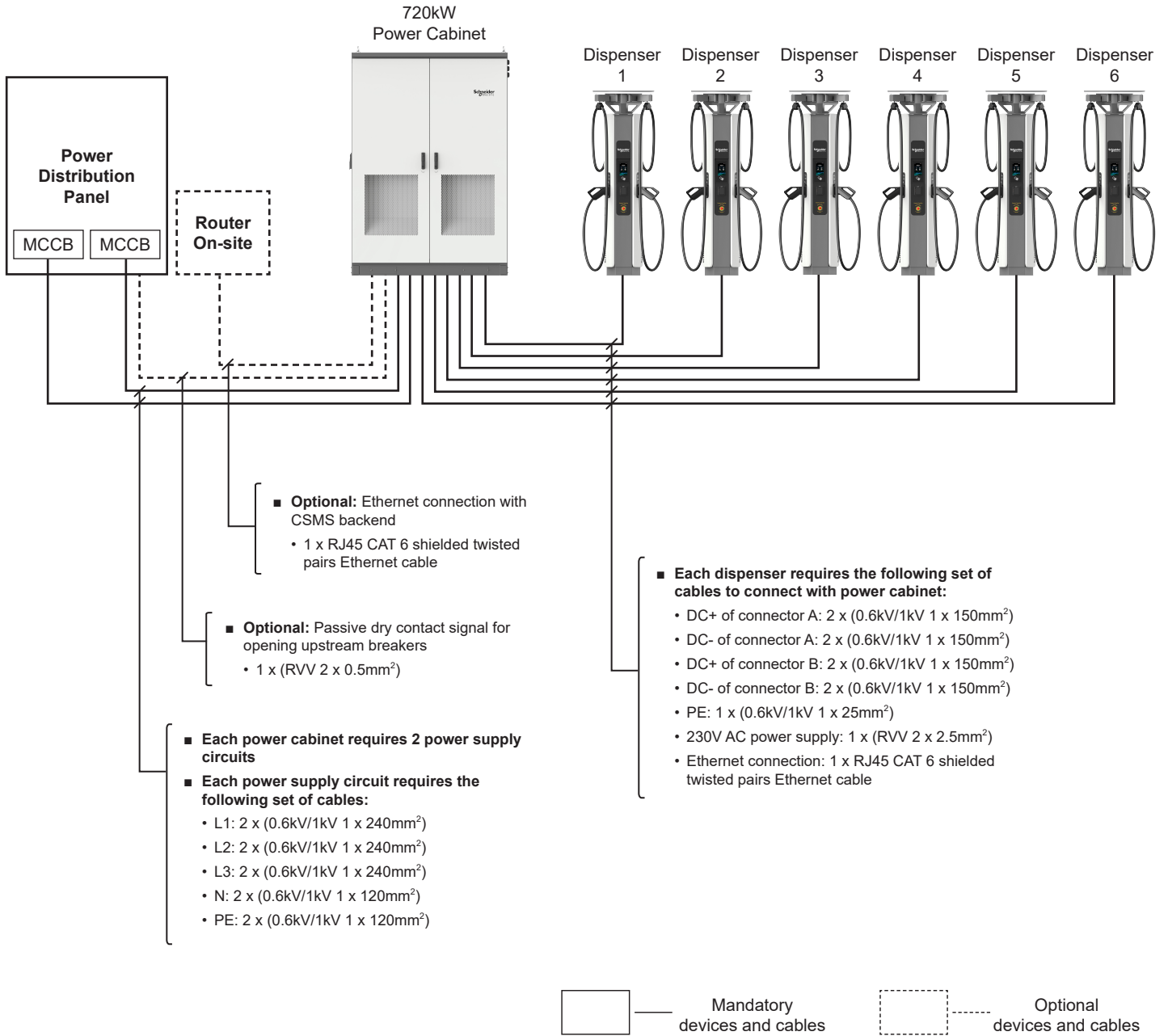

1.1 Charging Stations Configurations

Type of equipment applicable to this manual: Schneider StarCharge Fast Nova/Aries System;
List of references supported are:

| Commercial Reference | Nominal Power | Vehicle connector | Cable management | Cable range (m) | Payment Terminal |
|----------------------|---------------|-------------------|------------------|-----------------|----------------------|
| EVD1S360 | 360 kW | NA | NA | NA | NA |
| EVD1S480 | 480 kW | NA | NA | NA | NA |
| EVD1S483 | 480 kW | NA | NA | NA | NA |
| EVD1S720 | 720 kW | NA | NA | NA | NA |
| EVD1D720TBB | NA | 2 x CCS2 | Yes | 4.1 | No |
| EVD1D720TBBC7 | NA | 2 x CCS2 | No | 6.9 | No |
| EVD1D720TBBC | NA | 2 x CCS2 | Yes | 4.1 | Yes (Payter Appollo) |
| EVD1D720TBCC1 | NA | 2 x CCS2 | Yes | 4.1 | Yes (PAX IM30) |

* For more customized commercial reference, please contact Schneider Electric.

DC Electric Vehicle Charging Station

Commercial ref: EVD1D720TBCC DC7600EN181401

Serial Number:

AC Rated Input : 220-240V AC 1P+N+PE 10A 50/60 Hz
DC Rated Input : 150-1000V DC

Operating Temp.: -30°C~50°C (up to 55°C with derating)

For industrial areas

Protection: IP55 IK10 (IK08 screen)/Class I

| | | |
|-----------------------|--------------|--------------|
| Connector Type : | CCS2 | CCS2 |
| Output Voltage: | 150-1000V DC | 150-1000V DC |
| Rated Output Current: | 380A | 380A |
| Max Output Current: | 600A | 600A |

EN IEC 61851-1 EN 61851-23 IEC 61439-7

Manufactured by:
Schneider eStar
35 rue Joseph Monier
92500 Rueil-Malmaison France

UK
CA

CE



MFD:

Made in China

Here is an example of a Charging Station nameplate.

1.2 Authentication Modes

According to the Commissioning parameters, the Schneider StarCharge Fast 720 Charging Station operation is possible with or without authentication.
Operation with authentication requires a Charging Station connected to an OCPP backend platform.

Authentication modes available:

- Authentication Required, with option:
 - RFID/NFC
 - QR code with Mobile APP
 - Payment terminal
 - EV MAC address
 - ISO 15118 Plug n Charge
- Free charging mode without authentication

1.3 Payment Methods

Depending on Charging Station reference and on the commissioning parameters required, Charging Stations may have several payment options:

- Mobile App
- RFID Card
- Payment Card
- Auto Charge (Mac Address)
- ISO15118 Plug and Charge

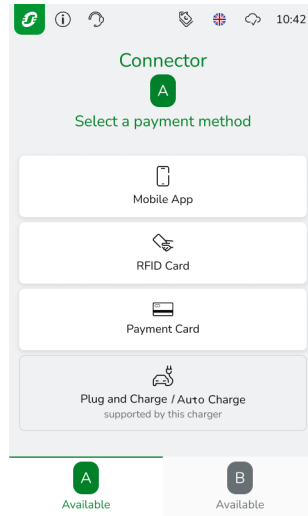

1.4 LED Status Indicator

The status of the Schneider StarCharge Fast 720 charging station is indicated via colored LED indicator lights.

Below you will find the definition of each Indicator Light and its corresponding charger status and the basic user guidance: (Sticker provided with the unit)

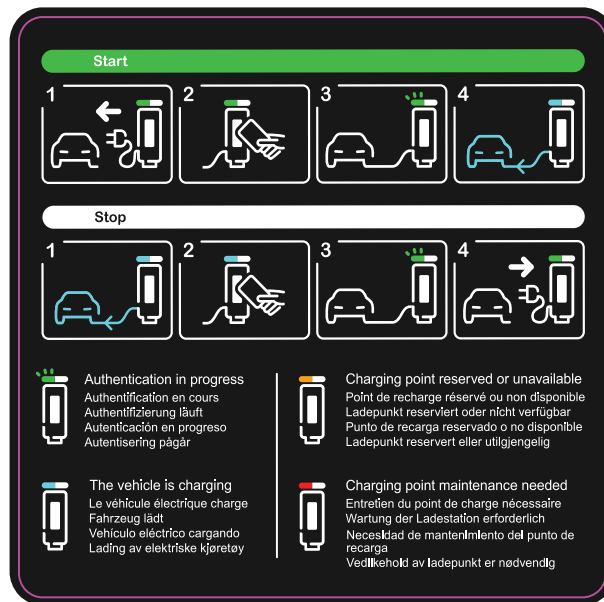

1.5 Languages

The Schneider StarCharge Fast 720 Charging Station User interface is integrated in several languages to facilitate the use according to regional requirements and enable different users. In the top of the HMI screen you can press on the Flag icon which will take you to a menu to select your preferred language.

NOTE: The list of available languages are defined at the commissioning stage.

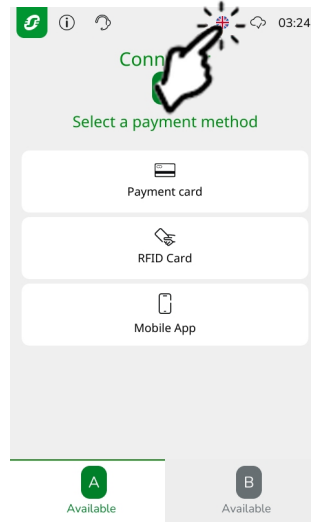

Available Languages:

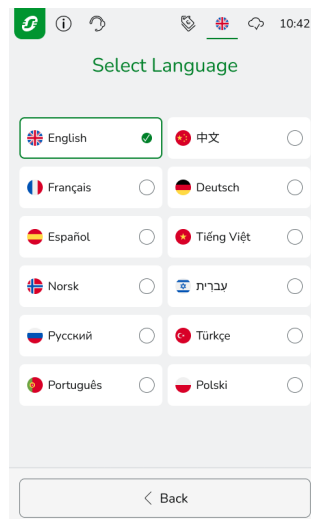

1.6 Tariff

If the backend platform issues a tariff to the charging station as a payment reference, an icon will appear at the top of HMI screen. Click the "Tariff" icon and the further information of charging tariffs will pop up.

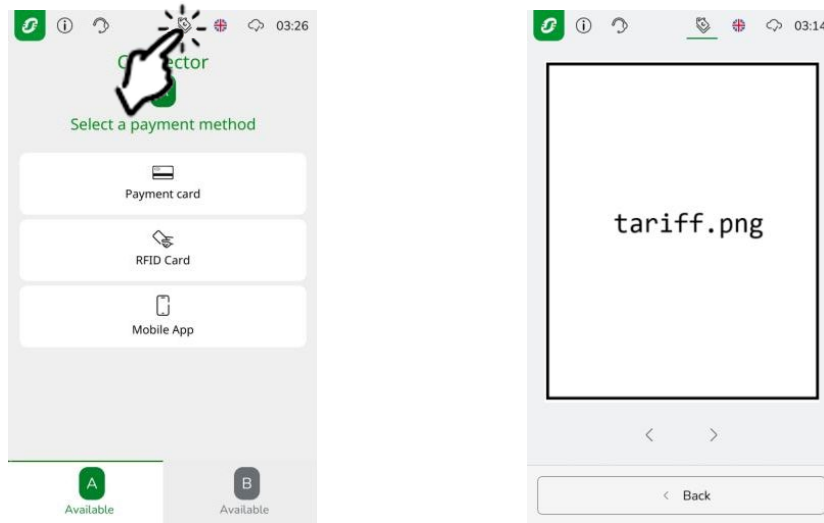

1.7 Charger Information

Click the "info" icon will show the information of the charger device, including the charger ID, software version and connector ID of connector A and B.

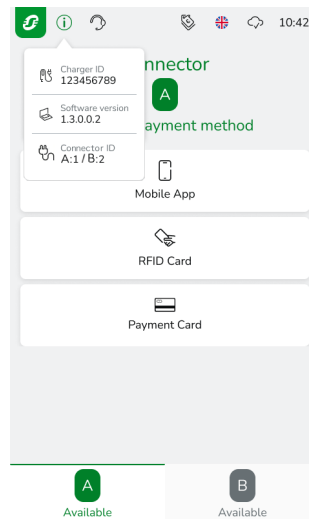

1.8 Service Information

Click the "headset" icon will show the service information, including the hotline number and the working time.

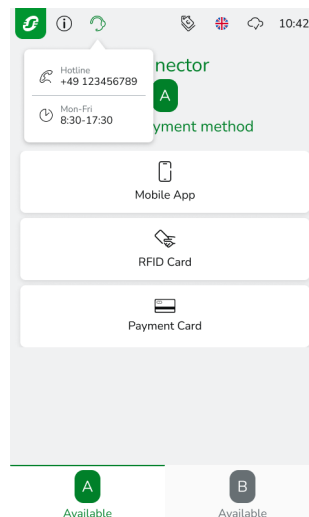

1.9 Charge Session DC Meter Reading

The Schneider StarCharge Fast Charging Station is equipped with a visible DC meter on each outlet. It provides the measurement data records with timestamp, loading process data and digital signature, thereby enabling charging processes to be billed in accordance with the legal requirements. Furthermore, all charging processes are persistently stored in the internal data storage of the meter.

The rotation interval on the display screen is 5 seconds.

Displayed Information:

- Total import mains energy
- Total transaction import device energy

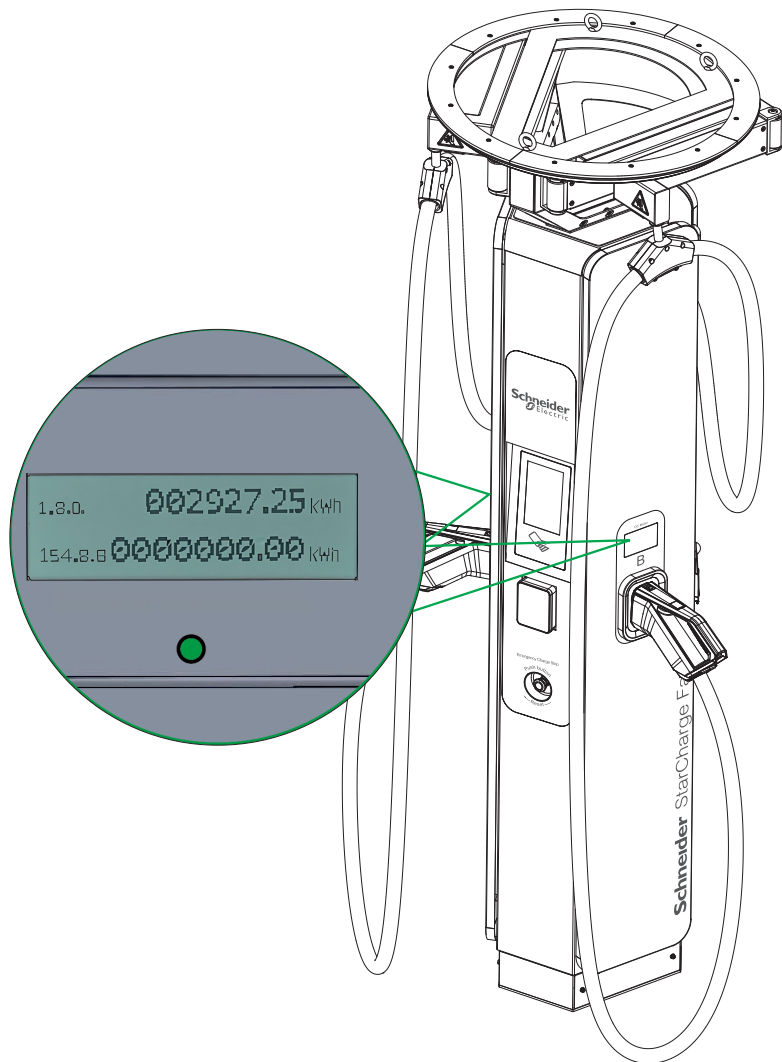

2.1 Basic Charging Steps

To charge an Electric Vehicle(EV):

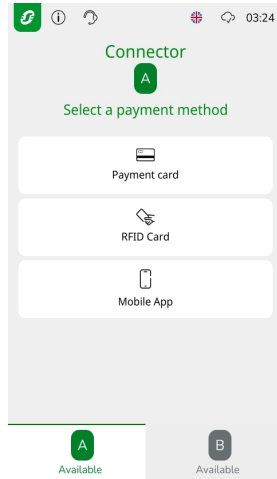

- A • Park the Electric Vehicle with the charge inlet within reach of the vehicle connector suitable for your Electric Vehicle.
- B • Confirm the Charging Station status is normal and the status indicator is steady green.
- C • Select your preferred Language.
- D • Follow the instructions on the screen.

⚠ CAUTION

HAZARD OF DAMAGING A LOCKED VEHICLE CONNECTOR.

- In CCS charging the Electric Vehicle locks the vehicle connector.
- If the user wants to unplug the vehicle connector from the car, it may be necessary to unlock all doors of the Electric Vehicle or use the "unlock charge connector button" on the car key, if present.
- Do not apply force to a locked vehicle connector during charging. This might damage the inlet and locking mechanism in the car or damage the Charging Station.
- Always handle cables and connectors with care & always place them back in their respective holders.
- Only insert a vehicle connector into a suitable car inlet.

Failure to follow these instructions can result in injury or equipment damage.

PLEASE NOTE

- Always Ensure that the vehicle connector is properly plugged in the Electric Vehicle.
- Always Ensure that the vehicle connector openings are clean and clear of any foreign bodies, dust, sand, leaves, etc.

2.2 Charging Authentication Modes

Depending on the configured authentication modes below, the user instructions for the charger may vary depending on the customer requirements. For each authentication mode, EV drivers need to select the authentication mode when it's not free or using Mac Address or ISO15118 Plug n Charge authentication.

1. RFID/NFC Authentication Required

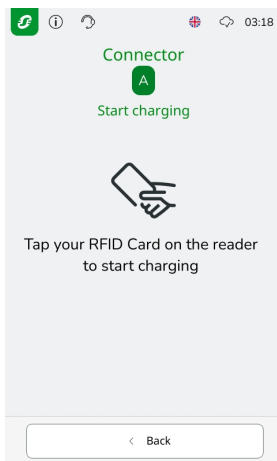

- A • All the following scenarios are available.
 - Scenario 1:
 - Step 1: Remove the vehicle connector A or B from the connector slot and insert firmly it into the corresponding charging port of the vehicle.
 - Step 2: Select the plugged connector A or B on the screen.
 - Step 3: Select RFID authentication, and follow on screen guide.
 - Step 4: Wait for charging start.
 - Scenario 2:
 - Step 1: Select the connector A or B on the screen.
 - Step 2: Select RFID authentication and follow on screen guide.
 - Step 3: Remove the vehicle connector A or B, selected in step 1, from the connector slot and insert firmly it into the corresponding charging port of the vehicle.
 - Step 4: Wait for charging start.
 - Scenario 3:
 - If one of the vehicle connectors is already charging or unavailable. Select the other unoccupied vehicle connector on the HMI screen. And then follow from Step 2 in Scenario1 or Scenario2.

2.2 Charging Authentication Modes

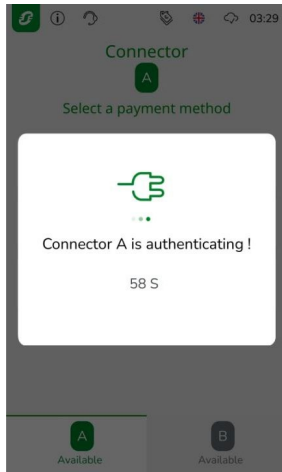

- B • One the RFID card is tapped the interface with show the authenticating message. Once authenticated the session will start.

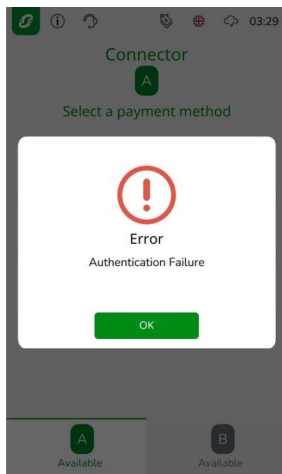

- C • If authentication fails, a message will appear.

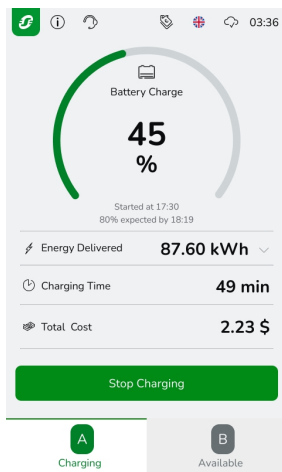

- D • During charging, touch A and B buttons on the bottom of the screen to switch to the status interface of each vehicle connector.
- E • Stop charging: Press "Stop Charging" to enter the stop charging interface and tap the card again to stop charging.

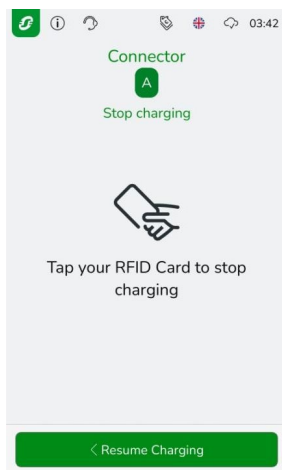

- F • Unplug the vehicle connector from the vehicle, reposition it in the connector slot.

2.2 Charging Authentication Modes

2. Authentication with EV MAC address

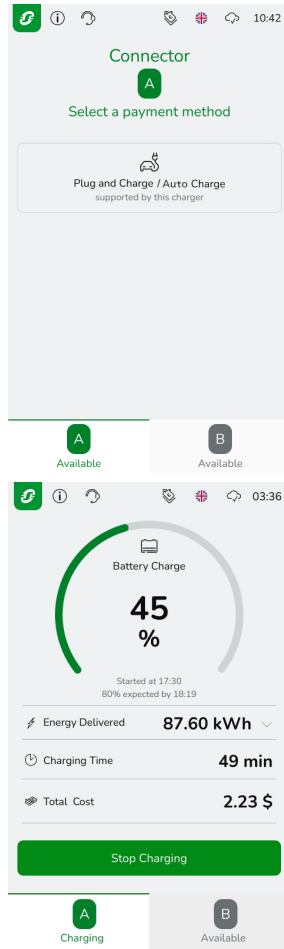

A • Remove the vehicle connector from the connector slot and insert firmly it into the corresponding charging port of the authorized vehicle to authenticate.

B • Stop charging: Press "Stop Charging" to enter the stop charging interface or stop the charge from the vehicle.

C • Replace the connector in the holder.

NOTE: The "Stop Charging" button needs special commissioning in web page (please refer to Commissioning Guide).

3. Free charging mode without authentication

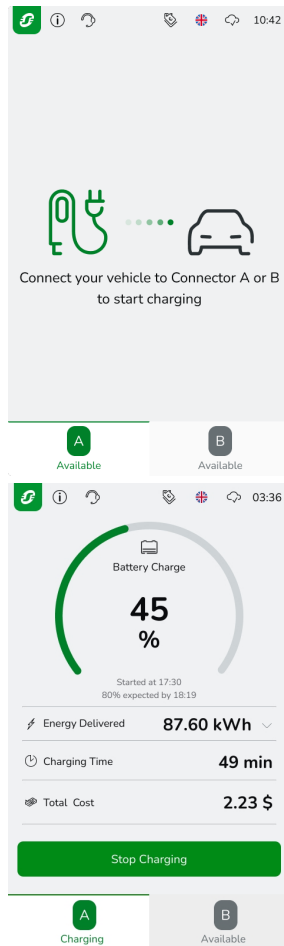

A • Remove the vehicle connector from the connector slot and insert firmly it into the corresponding charging port of the vehicle, charge session will start Automatically.

B • To stop the charging session, either of the following methods can be used:

- Use the connector unlock feature on the electric vehicle.
- Press "Stop Charging" button on the HMI screen (Only when the button is enabled in commissioning stage. Please refer to Commissioning Guide.).

C • Replace the connector in the holder.

2.2 Charging Authentication Modes

4. QR code with Mobile APP

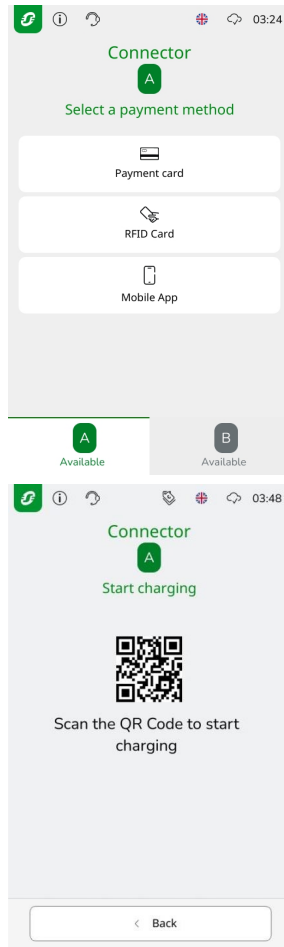

- A • All the following scenarios are available.

Scenario1:

Step1: Remove the vehicle connector A or B from the connector slot and insert firmly it into the corresponding charging port of the vehicle.

Step2: Select the plugged connector A or B on the screen.

Step3: Select QR authentication, and follow on screen guide.

Step4: Scan the pop-up QR code to start the charging session and follow the instruction given by the Charge Point Operator to start and stop charging session.

Scenario 2:

Step1: Select the connector A or B on the screen.

Step2: Select QR authentication and follow on screen guide.

Step3: Scan the pop-up QR code to start the charging session and follow the instruction given by the Charge Point Operator to start and stop charging session.

Step4: Remove the vehicle connector A or B, selected in step 1, from the connector slot and insert firmly it into the corresponding charging port of the vehicle.

Scenario 3:

If one of the vehicle connectors is already charging or unavailable. Select the other unoccupied vehicle connector on the payment terminal screen. And then follow from Step 2 in Scenario 1 or Scenario 2.

- B • Stop charging: Press "Stop Charging" to enter the stop charging interface and follow the instruction given by the Charge Point Operator again to stop charging.
- C • After the charging session stops, replace the connector in the holder.

5. Payment terminal

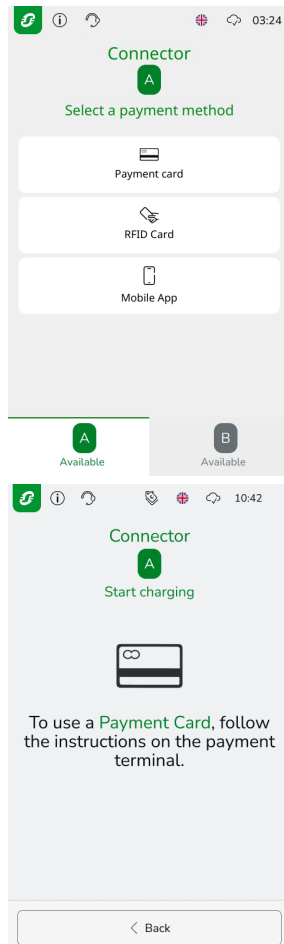

- A • All the following scenarios are available.

Scenario1:

Step1: Select the connector A or B on the screen.

Step2: Click the Payment terminal icon on screen HMI.

Step3: Follow the instruction on the screen of the payment terminal including selection of connector A or B.

Step4: Then tap the credit card. Remove the vehicle connector A or B from the connector slot and insert firmly it into the corresponding charging port of the vehicle.

Step5: Wait for charging start.

Scenario2:

Step1: Remove the vehicle connector A or B from the connector slot and insert firmly it into the corresponding charging port of the vehicle.

Step2: Select the plugged connector A or B on the screen.

Step3: Click the Payment terminal icon on screen HMI.

Step4: Follow the instruction on the screen of the payment terminal including selection of connector A or B, then tap the credit card.

Step5: Wait for charging start.

Scenario3:

If one of the vehicle connectors is already charging or unavailable.

Select the other unoccupied vehicle connector on the payment terminal screen. And then follow from Step2 in Scenario1 or Scenario 2.

NOTE: If CSMS already has integrated with Payter or PAX backend, the payment terminal will indicate connector selection option on the screen.

- B • Stop charging: Press "Stop Charging" to enter the stop charging interface and follow the instructions on the payment terminal again to stop charging.
- C • Replace the connector in the holder.

3.1 Charging Session Statistics

During the charging sessions the Schneider StarCharge Fast can provide different readings and statistics about the ongoing session(s)
To pick the charging session during charging, touch A and B buttons on the bottom of the screen to switch to the status interface of each vehicle connector.

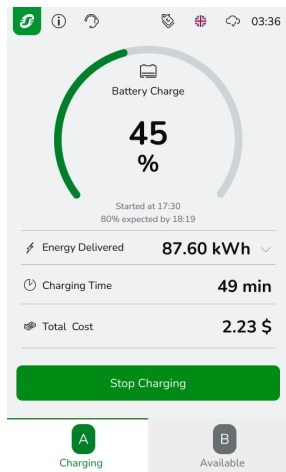

On the main screen of the Charging Station will appear the general status of the charging session such as:

- Session start time
- Elapsed time
- Estimated completion time
- Energy delivered in kWh
- Cost/billing amount (if information is provided by CSMS backend)
- Charging Power, Output Current and Output Voltage (need to expand the arrow on the left side of the screen)

3.2 Charge Session Report

At the end of a charge session, the Charging Station will display on the user interface a report of the statistics of the charge session.

Session end

- Charging will stop without user interaction when the Electric Vehicle indicates to the charger that charging is completed.
- Charge session can also be ended from the Electric Vehicle side, refer to the Electric Vehicle owners manual.

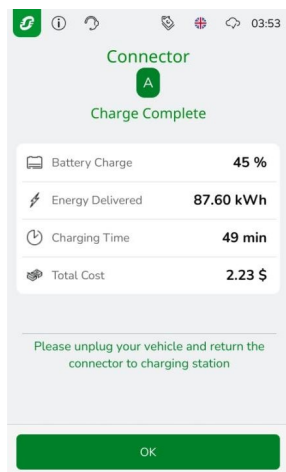

Available Information:

- Electric Vehicle battery Level in %
- Energy delivered in kWh
- Cost/billing information (if information is provided by CSMS backend)
- Duration of charge session

3.3 Screen saver and logo change

The logo picture showing on the upper left corner of the HMI screen can be changed (in commissioning stage) according to the requirement from Charge Point Operator/Contractor.
Once the HMI screen is not operated within 2 minutes, the screen saver will start (Only when the screen saver feature is enabled in commissioning stage). The screen saver pictures will be changed at regular intervals (10s) if there are more than one screen saver picture. The maximum screen save pic number is 2.

⚠ ⚠ DANGER**HAZARD OF ELECTRIC SHOCK**

- Any inspection or maintenance activity that requires the Charging Station doors to be opened must only be performed by trained and authorized personnel.
 - Contact Schneider Electric services to provide the recommended service plan for your product.
- Failure to follow these instructions will result in death, serious injury.**

NOTICE**HAZARD OF EQUIPMENT DAMAGE**

- Do not apply high-pressure water jets when cleaning the charging station as water may leak inside.
 - Only use cleaning agents with a pH value between 6 and 8.
 - Do not use cleaning agents with abrasive components.
 - Do not use abrasive tools.
- Failure to follow these instructions can result in equipment damage.**

























To achieve the best performance out of your Schneider StarCharge Fast Charging Station preventive maintenance plan is required. The preventive maintenance plan consists of regular maintenance and periodic maintenance.

Regular maintenance aims to offer a regular check for the status of the Charging Station under the condition when shut down is not possible.

Periodic maintenance is to be carried out at least once a year by Schneider Electric services personnel or trained and certified Schneider Electric's eMobility EcoXpert.

Regular Maintenance

Regular maintenance checklist as follow:

| Regular Maintenance | | | | |
|--|---|-----------|-------------------|---------------|
| Check | Tool | Frequency | Shutdown Required | Status/Action |
| Visually check whether there are missing parts such as connector holder, Emergency charge stop, handles, etc. |  | Weekly | No | |
| Visually check whether there are deformed or damaged parts on enclosure. |  | Weekly | No | |
| Ensure cleanliness of enclosure for stains, stickers, graffiti, grease, signs of rust, signs of burn or water penetration. |  | Weekly | No | |
| Check the HMI screen for damages and ensure proper visibility and touch response. |  | Weekly | No | |
| Test the QR code to ensure it is clear and leads to the correct App/Interface. |  | Weekly | No | |
| Check the HMI screen for any error messages. |  | Weekly | No | |
| Check the LED indicator lights. |  | Weekly | No | |
| Visually inspect the condition of the connectors and cables for any foreign objects, damages, or broken insulation. |  | Weekly | No | |
| Visually inspect the cable at the connector flange for any pull marks. |  | Weekly | No | |
| Manually test the proper operation of the cable management system and ensure that it can withdraw back a loose cable. |  | Weekly | No | |
| Inspect and verify the correct operation of the Emergency charge stop. |  | Weekly | No | |
| Check the car stopping bollards are present and not damaged. |  | Weekly | No | |
| Visually inspect the concrete foundation for water collected or damages and ensure all bolts are secured in place. |  | Weekly | No | |
| Visually inspect the canopy/shed for any damages. (if applicable). |  | Weekly | No | |
| Ensure the installation area is clear of weeds, sand, excessive dust, etc. |  | Weekly | No | |
| Visually inspect all safety warning signs visible and clear. |  | Weekly | No | |
| Manually inspect the doors and locks for proper operation and keys are secured. |  | Weekly | No | |
| Listen whether there is abnormal noise from inside of the charger. |   | Weekly | No | |
| Check for abnormal (burning, rodent) smell coming from the charger. |   | Weekly | No | |
| Inspect the DC meter through the window and ensure clear reading visibility. |   | Weekly | No | |
| Inspect and clean the intake ventilation louvers for damages or any foreign objects blocking. |  | Weekly | No | |
| Inspect and clean the outlet ventilation grid for damages or any foreign objects blocking. |  | Weekly | No | |

**Product Disposal**

To comply with Directive 2012/19/EU of the European Parliament and of the Council of 4 July 2012 on waste electrical and electronic equipment (WEEE), devices marked with this symbol may not be disposed of as part of unsorted domestic waste inside the European Union. Enquire with local authorities regarding proper disposal.

Product materials are recyclable as marked.

Please find below link and enter the product reference number for files: Product Environmental Profile and Product End of Life Instructions

checkaproduct.se.com

Radio Equipment Conformity

EU Declaration of Conformity

Schneider StarCharge Fast 720 is in compliance with the essential requirements and other relevant provisions of Radio Equipment Directive: 2014/53/EU.

The EU declaration of conformity for Schneider StarCharge Fast 720 Power Cabinet offer (EU1007172-0) and Schneider StarCharge Fast 720 Dispenser (EU1007178-0) can be downloaded on: www.se.com/docs.

UK Declaration of Conformity

Schneider StarCharge Fast 720 is in compliance with the essential requirements and other relevant provisions. of Radio Equipment Regulations 2017-UK SI 2017 No.1206.

The UK declaration of conformity for Schneider StarCharge Fast 720 Power Cabinet offer (UK1007176-0) and Schneider StarCharge Fast 720 Dispenser offer (UK1007180-0) can be downloaded on: www.se.com/uk/docs.

Communication Frequencies

| | Operation Frequency | Output Power |
|-----------------|---|--------------|
| RFID: | 13.56 MHz | < 20 mW |
| GSM900: | TX: 880 MHz to 915 MHz RX: 925 MHz to 960 MHz | 25.81 dBm |
| GSM1800: | TX: 1710 MHz to 1785 MHz RX: 1805 MHz to 1880 MHz | 22.81 dBm |
| WCDMA | | |
| Band1: | TX:1920-1980 MHz RX:2110-2170 MHz | 25.00 dBm |
| Band8: | TX:880-915 MHz RX: 925-960 MHz | 25.00 dBm |
| LTE | | |
| Band1: | TX:1920-1980 MHz RX: 2110-2170 MHz | 25.00 dBm |
| Band3: | TX:1710-1785 MHz RX:1805-1880 MHz | 25.00 dBm |
| Band7: | TX: 2500-2570 MHz RX: 2620-2690 MHz | 25.00 dBm |
| Band8: | TX: 880-915 MHz RX: 925-960 MHz | 25.00 dBm |
| Band20: | TX:832-862 MHz RX: 791-821 MHz | 25.00 dBm |
| Band28: | TX: 703-748 MHz RX: 758-803 MHz | 25.00 dBm |
| Band38: | 2570-2620 MHz(TDD) | 25.00 dBm |
| Band40: | 2300-2400 MHz(TDD) | 25.00 dBm |
| Band41: | 2496-2690 MHz(TDD) | 25.00 dBm |

Wireless Frequencies

| Operate Freq. Band | Frequency Range (MHz) | Modulation | Channel Bandwidth | Data Rate |
|----------------------------------|--|------------|-------------------|----------------|
| IEEE 802.11b | 2412~2472 | DSSS | 20MHz | Up to 11Mbps |
| IEEE 802.11g | 2412~2472 | OFDM | 20MHz | Up to 54Mbps |
| IEEE 802.11n 2.4GHz 20MHz | 2412~2472 | OFDM | 20MHz | Up to 72.2Mbps |
| Channel Number | IEEE 802.11b/g, IEEE 802.11n HT20: 13 Channels | | | |
| Channel Step | WiFi: Channels with 5MHz step | | | |

Standards and Compliance

| Directive RE: 2014/53/UE | RE Directive: 2014/53/EU |
|---|---|
| Directive RoHS: 2011/65/UE, 2015/863/UE | RoHS Directive: 2011/65/EU: 2015/863/EU |

Based on following standards:

EN IEC 61851-1:2019+AC:2023-12, EN 61851-23:2014+AC:2016-06, EN 61851-24:2014 + AC:2015, EN 61000-6-2:2005 + AC 2005,

EN IEC 61000-6-2:2019*, EN 61000-6-4:2007 + A1:2011, EN IEC 61000-6-4:2019**, EN IEC 61851-21-2:2021***

EN 301 489-1 V1.9.2(2011-09), EN 301 489-1 V2.2.3(2019-11)****, EN 301 489-3 V2.3.2(2023-01), EN 301 489-17 V3.2.4(2020-09)

EN 301 489-17 V3.3.1(2024-09), EN 301 489-52 V1.2.1(2021-11), EN 301 489-52 V1.3.1(2024-11)

EN 300 330 V2.1.1(2017-02), EN 301 511 V12.5.1(2017-03), EN 301 908-1 V15.2.1(2023-01), EN 301 908-2 V13.1.1(2020-06),

EN 301 908-13 V13.2.1(2022-02), EN 301 908-13 V13.3.1(2024-10)****, EN 300 328 V2.2.2(2019-07)

EN 62311:2008, EN IEC 62311:2020, EN 62479:2010

IEC 61439-7:2018

EN IEC 63000:2018

EN 18031-1:2024, EN 18031-2:2024, EN 18031-3:2024

EN ISO 15118-1:2019, EN ISO 15118-2:2016, EN ISO 15118-3:2016, EN ISO 15118-4:2019, EN ISO 15118-5:2019

* The EN IEC 61000-6-2:2019 is not a harmonized standard but the Schneider StarCharge Fast 720 is already compliant with EN IEC 61000-6-2:2019.

** The EN IEC 61000-6-4:2019 is not a harmonized standard but the Schneider StarCharge Fast 720 is already compliant with EN IEC 61000-6-4:2019.

*** The EN IEC 61851-21-2:2021 is not a harmonized standard but the Schneider StarCharge Fast 720 is already compliant with EN IEC 61851-21-2:2021.

**** The EN 301 489-1 V2.2.3 (2019-11) is not a harmonized standard but the Schneider StarCharge Fast 720 is already compliant with EN 301 489-1 V2.2.3(2019-11).

***** The EN 301 908-13 V13.3.1 (2024-10) is not a harmonized standard but the Schneider StarCharge Fast 720 is already compliant with EN 301 908-13 V13.3.1(2024-10)

