

LUMA 230V





LUMA 230V SMOKE ALARM



IF ONE ALARMS, THEY ALL SOUND

Early warning, no matter where the fire starts.



230V WITH 10 YEARS BACKUP BATTERY

Built-in 3V battery included.



HUB & APP COMPATIBLE

Notifications on mobile.



Quickly connect cables

Tool free cable installation

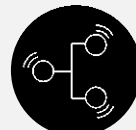

WIRELESS AND WIRED

40 units wireless and 20 units wired



DUST PROTECTION

Protect the smoke alarm during construction and renovation



Placement

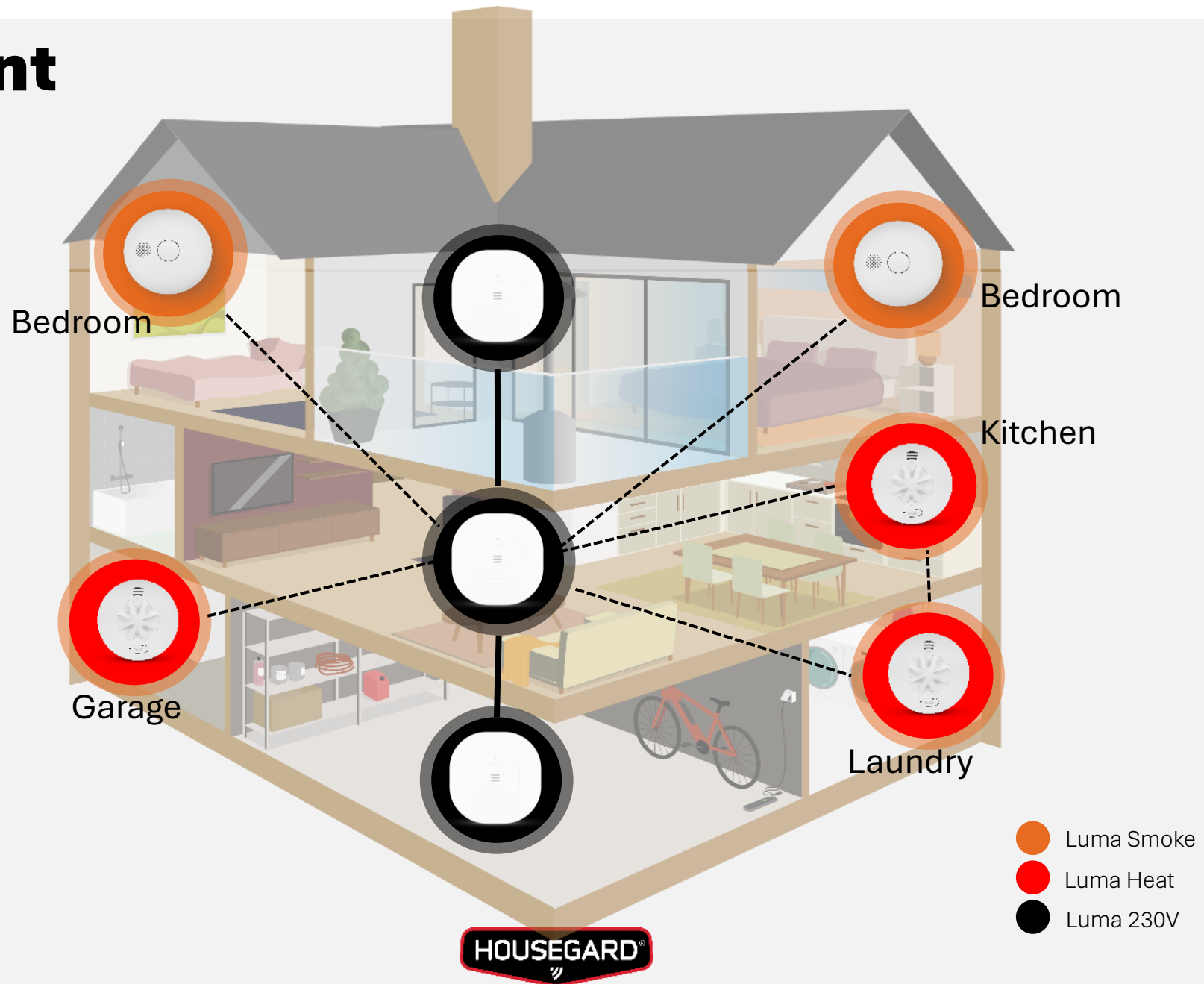

How to install?

1. SCREW INTALLATION

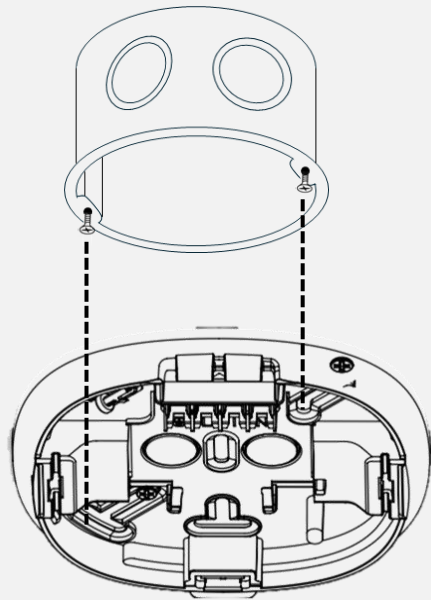

FITS \varnothing 60-100 mm
JUNCTION BOX

2. WIRE ROUTING

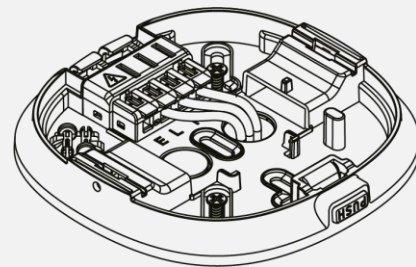
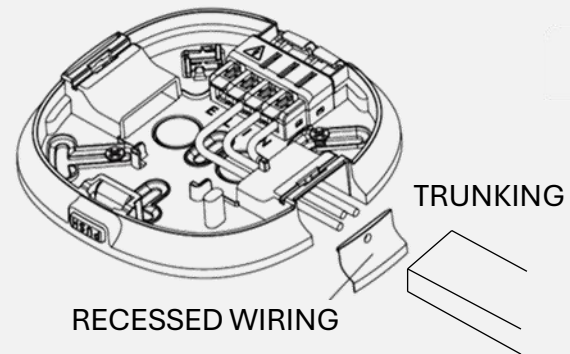

RECESSED WIRING

3. EASY FIX

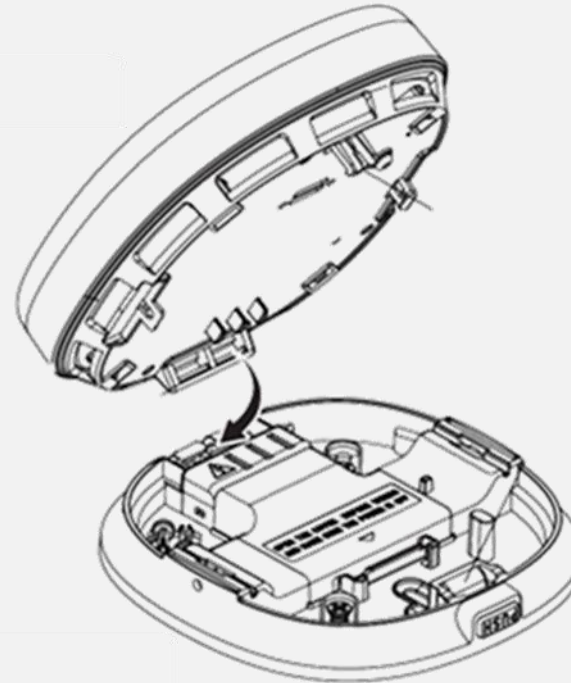

4. SAFETY

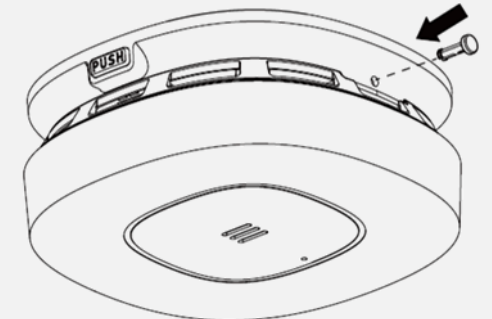

LOCKING PIN

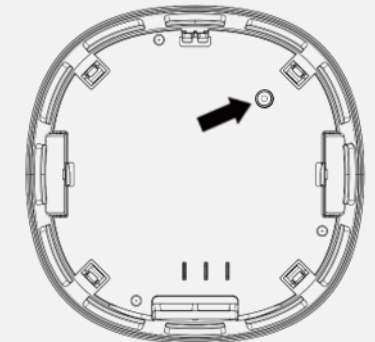

TAMPER ALARM

How to connect?

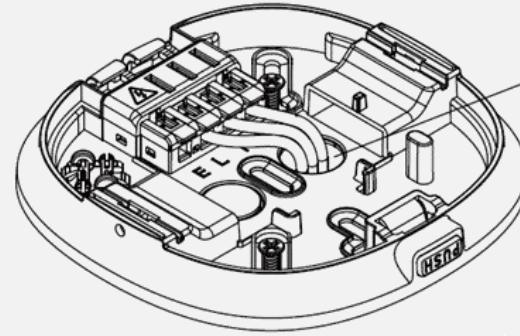
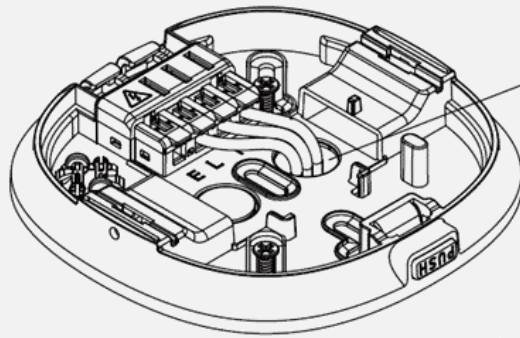

CONNECTIONS:

- - - - Earth (E)
- Live (L)
- Interconnect (I)
- - - - Neutral (N)

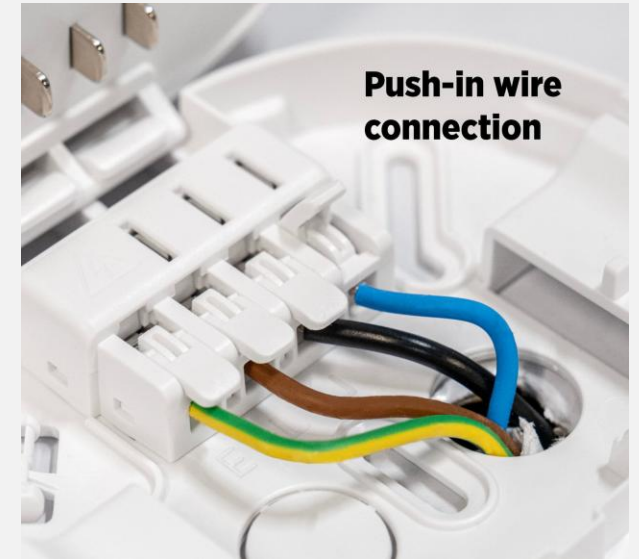
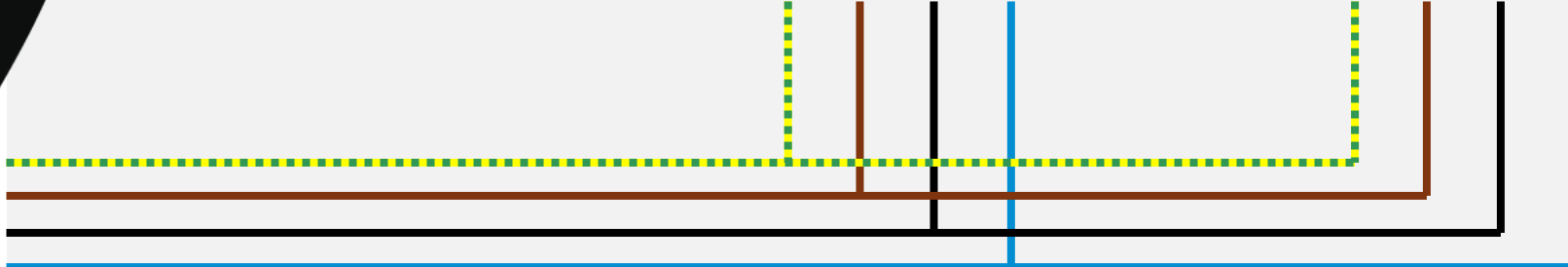
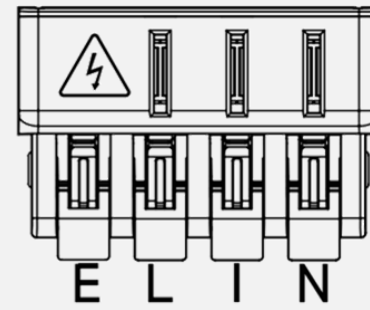
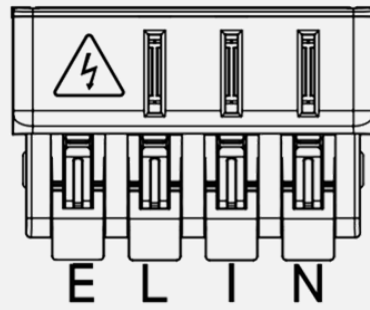

Push-in wire connection

LUMA Hub



Connects **LUMA** products to your mobile phone.



Receive notifications for alarms, low battery levels, and tampering.



Through the app, you can test, pause, and check the current battery level.



SMART
LIFE

Powered by

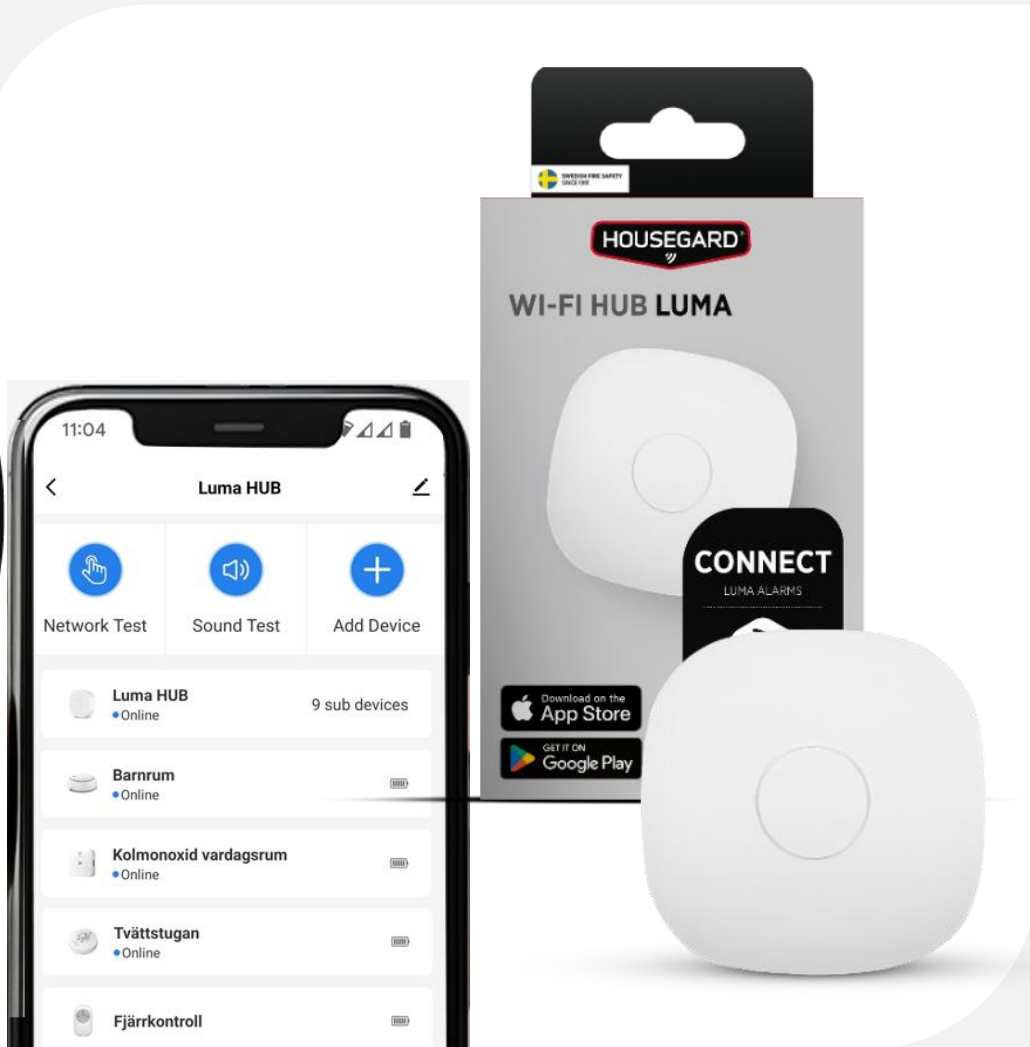

Types of installation on the market

PUSH-IN WIRE

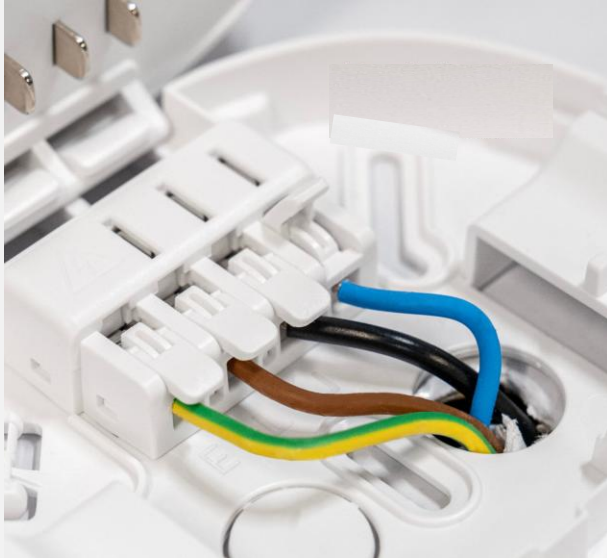

SCREW INSTALLATION



CONTACT INSTALLATION



How to pair?

Step 1

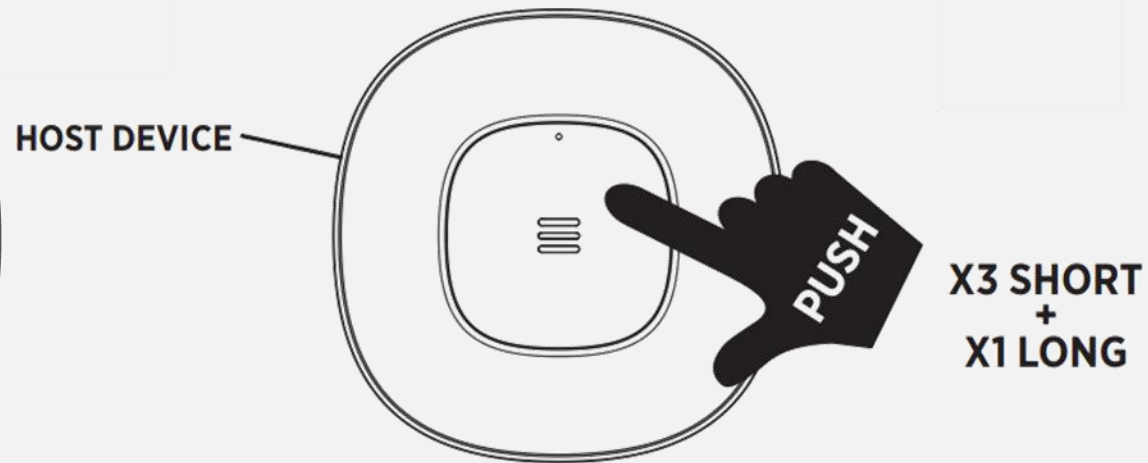

Step 2

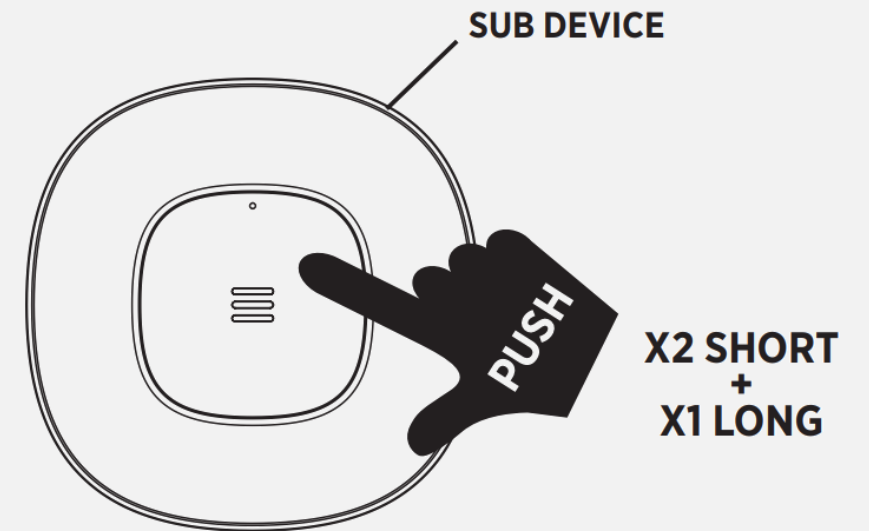

How to connect

**WIRELESS
CONNECTION**

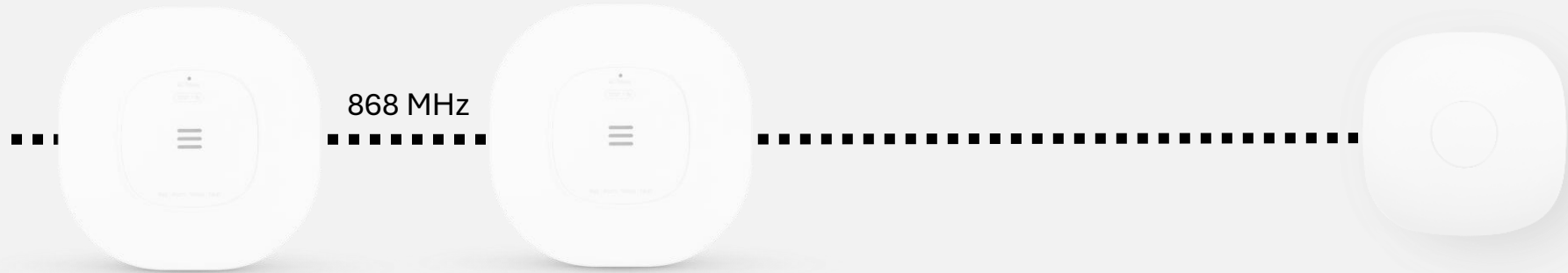

**WIRED
CONNECTION**

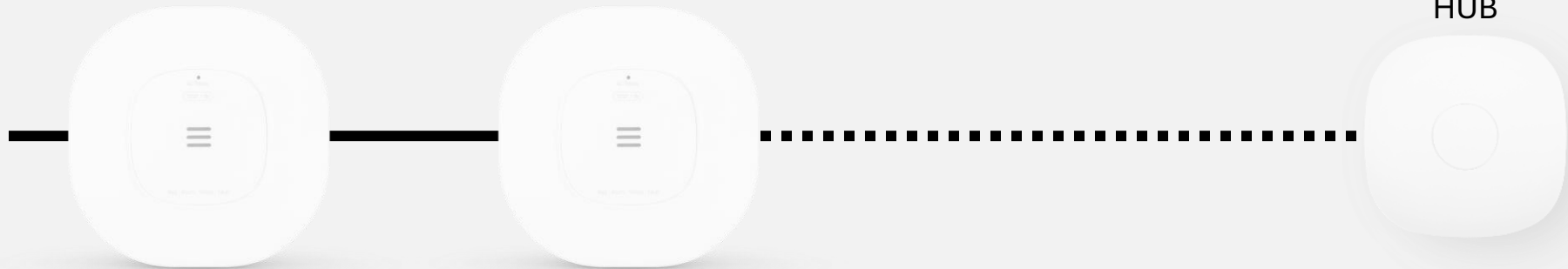

**HYBRID
WIRED & WIRELESS
CONNECTION**

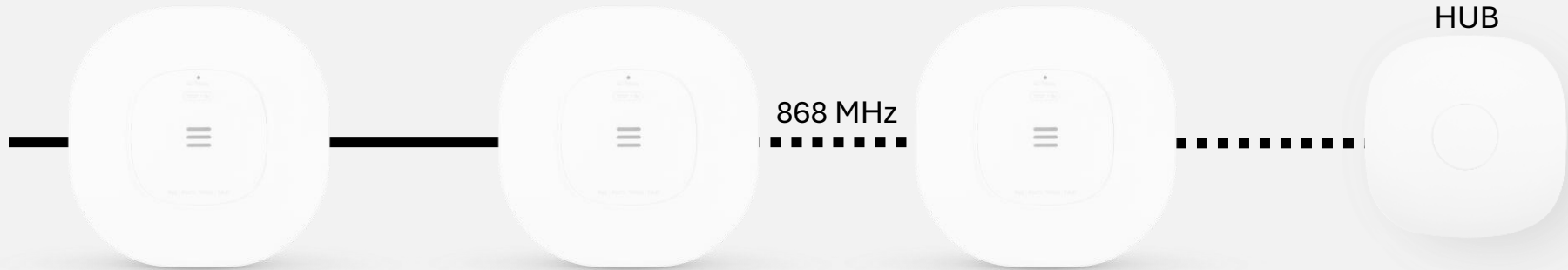

Size?



Ø125 mm
Luma 230V



Ø120 mm
ORIGO



Ø128 mm
SA411S



Ø 86 mm
LUMA



46 mm



Size?



ø125 mm
Luma



ø150 mm
EI 3016



ø150 mm
EI146



ø127 mm
KIDDE

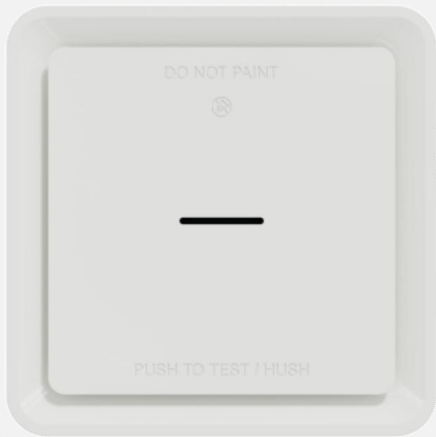

ø115 mm
SCHNEIDER



ø125 mm
DAFO



ø97 mm
CAVIUS



ø 120 mm
NEXA, MELBYE, FOSS, LIFE
WAVE, HARJU



ø141 mm
FIREANGEL

Competition 10Y



LUMA

EI
3016

EI
146

KIDDE
KF10

KIDDE
KF20R

Schneider
Wiser

DAFO

FIREANGEL
WSM-F

NEXA
MELBYE
FOSS
LIFE WAVE
HARJU

Cavius

LOWEST
PRICE

499

500

400

500

320

1200

500

1500

850

BATTERY

10Y

10Y

1-5Y

10Y

1-5Y

10Y

5Y

10Y

1-10Y

5Y

PUSH IN
WIRE

✓

APP

✓

✓

✓

✓

HYBRID

✓

✓

✓

✓

✓

PRICE



	RSP incl. VAT
SEK	499
NOK	499
EUR	45
DKK	349

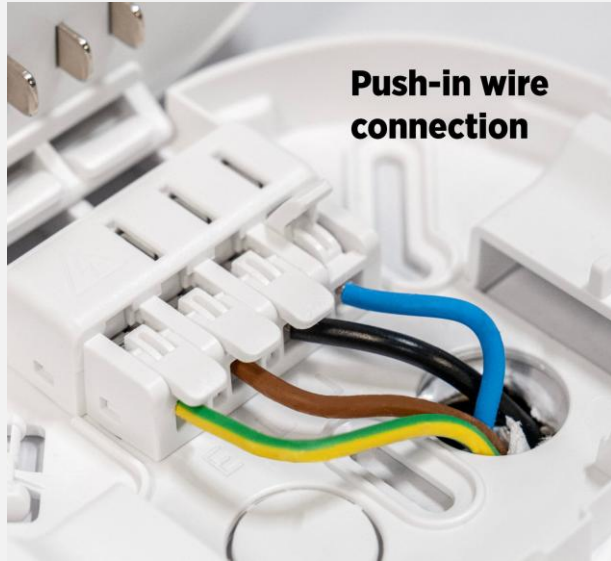

Easy to install

Tool free cable installation

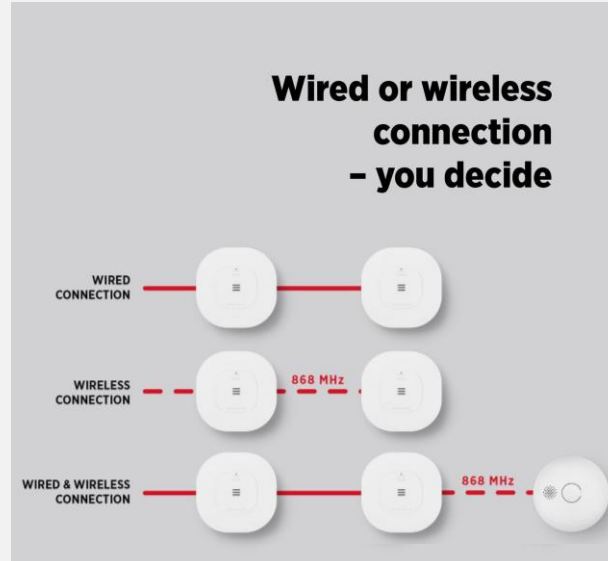

Easy to connect

Hybrid network with both wired and wireless connection



Easy to monitor

Connect to smart phone with Luma Hub



Framtida möjligheter



BRANDVARNARE

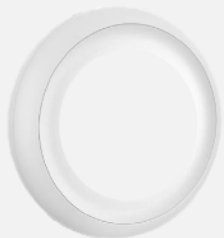

FJÄRRKONTROLL



CO-ALARM



Hub



LUMA BLACK
Q1 2026



BRANDVARNARE AC 230V
Jan 2026

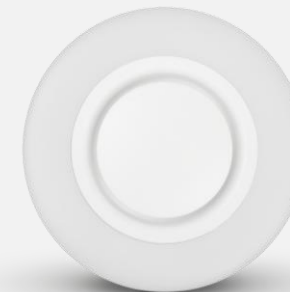

SIREN



TEMPERATURVARNARE