

Ceiling diffusers



About Lindab	1
Comfort and Design	2
Product overview / symbols	3
Theory	4
Ceiling diffusers	5
Ceiling diffusers - visible	6
Plenum boxes	7
Wall diffusers	8
Nozzles	9
Ventiduct	10
Grilles	11
Displacement diffusers	12
Pascal and VAV	13
Constant- / variable flow dampers	14
Air valves	15
Fresh air valves/overflow units	16
Cleanroom diffusers	17
Contents	18

Ceiling diffusers

1
2
3
4
5
6
7
8
9
10
11
12
13
14
15
16
17
18

Formo

Aesthetic design



Product	Page
Introduction	51
Overview of combinations	53
PKA	57
PCA	69
LKA	81
LCA	93
CRL	105

Integra

Integrated design



Product	Page
Introduction	117
Overview of combinations	121
PC6	125
PC7	135
RC14	141
RC15	151
NC19	161
RCG	169
LCC	176
LKP/LCP	177

Versio

Countless opportunities



Product	Page
Introduction	187
Overview of combinations	188
PS1	195
PS8	205
RS14	213
RS15	227
RS16	239
NS19	247
GS23	255

Lineo

Clean lines



Product	Page
Introduction	261
MTL	265
STB	272
STU	272

Extraction above ceiling



Product	Page
PCY	273
PKY	273

Ceiling tile adaption

274

Lindab Formo

a series of architecturally designed diffusers



PCA, Terminal 3 - Copenhagen Airport

Lindab Formo

Mixed ventilation is the most used principle of ventilation there is. Mixed ventilation is typically used in offices and similar rooms, where you wish to maintain low velocities in the occupied zone as well as low temperature gradients from floor to ceiling. The best results with mixed ventilation is obtained by spreading the air over the entire ceiling area, so that the velocity can subside as much as possible before reaching the occupied zone. There is a large selection of ceiling diffusers in different designs and with different functions, which can be used depending on the room's dimensions.

Functionality

Formo mixed ventilation diffusers are known by the diffusers being suspended from the ceiling with a single slot around the diffusers. The diffusers are offered in circular, or square designs with perforated or plain front plates. The diffusers have a very high capacity and are available with several different types of accessories. The circular diffusers are normally cut directly into the ceiling when mounted, but can by using tileplates be adapted for the most common 600x600 mm ceiling systems. On the next few pages, is illustrated a combinatic overview which will provide for a good insight to the series.



PCA, ceiling diffuser

Lindab Formo

a series of architectural designed diffusers

Design

See [Comfort and design](#)



Ventilations - principle
Supp./Exhau.

Accessories

Details, see productpages



Product

	Perforated - square	Perforated - circular	Plain - square	Plain - circular	Plain - circular
PKA	 125 160 200 250 315 400	 100 125 160 200 250 315 400	 125 160 200 250 315 400	 100 125 160 200 250 315 400	 100 125 160 200 250 315 400
	El. - motor	El. - motor	El. - motor	El. - motor	El. - motor
	Bracket	Bracket	Bracket	Bracket	Bracket
	Module pl.	Module pl.	Module pl.	Module pl.	Module pl.
	1, 2, 3 way	1, 2, 3 way	1, 2, 3 way	1, 2, 3 way	1, 2, 3 way
	Damper	Damper	Damper	Damper	Damper
	MBB box	MBB box	MBB box	MBB box	MBB box

Electrical motor:
See VAV chapter for further documentation.

- 1. Product and tech. data depicted in catalogue.
- 2. Combination possible. Tech. data depicted in catalogue.
- 3. Combination possible. Tech. data not in catalogue.
- 4. If space is empty, combination is not possible.

Example of order Diffuser + MBB box





PCA 160 + MBB 125 160 S

1
2
3
4
5
6
7
8
9
10
11
12
13
14
15
16
17
18

Lindab Formo a series of architectural designed diffusers

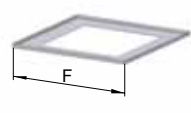
Ceiling tile adaption

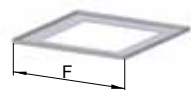
Details, see [Chapter ceiling tile adaption](#)

Product		Size	1	3	4	5	6	7
Ceiling types			Danotile T24/T15 Ecophon T24 Rockfon A24.	Permanent ceiling	Dampa Clip-In bevelled edge	Dampa Clip-In square edge	Luxalon SQ Clip-In	Danotile Contur Ecophon D Rockfon D-XL
Perforated - square		mm	F: 595 mm	A x A mm	F: 600 mm	F: 600 mm	F: 600 mm	F: 599 mm
PKA		125	●	Standard	●	●	●	●
		160	●	Standard		●	●	●
		200	●	Standard		●	●	●
		250	●	Standard		●	●	●
		315	●	Standard *			●	●
	400	●	Standard *				●	
Perforated - circular		mm	F: 595 mm	ØD mm	F: 600 mm	F: 600 mm	F: 600 mm	F: 599 mm
PCA		100	●	Standard	●	●	●	●
		125	●	Standard	●	●	●	●
		160	●	Standard	●	●	●	●
		200	●	Standard	●	●	●	●
		250	●	Standard	●	●	●	●
		315	●	Standard	●	●	●	●
	400	●	Standard	●	●	●	●	
Plain - square		mm	F: 595 mm	A x A mm	F: 600 mm	F: 600 mm	F: 600 mm	F: 599 mm
LKA		125	●	Standard	●	●	●	●
		160	●	Standard	●	●	●	●
		200	●	Standard	●	●	●	●
		250	●	Standard	●	●	●	●
		315	●	Standard *			●	●
	400	●	Standard *				●	
Plain - circular		mm	F: 595 mm	ØD mm	F: 600 mm	F: 600 mm	F: 600 mm	F: 599 mm
LCA		100	●	Standard	●	●	●	●
		125	●	Standard	●	●	●	●
		160	●	Standard	●	●	●	●
		200	●	Standard	●	●	●	●
		250	●	Standard	●	●	●	●
		315	●	Standard	●	●	●	●
	400	●	Standard	●	●	●	●	
Plain - circular		mm	F: 595 mm	ØA mm	F: 600 mm	F: 600 mm	F: 600 mm	F: 599 mm
CRL		100		Standard				
		125		Standard				
		160		Standard				
		200		Standard				
		250		Standard				
		315		Standard				
	400		Standard					

* In other ceiling systems the overpart of the diffuser is adapted to the ceiling. No separate Modulplatte.

- 1. Product and tech. data depicted in catalogue.
- 2. Combination possible. Tech. data depicted in catalogue.
- 3. Combination possible. Tech. data not in catalogue.
- 4. If space is empty, combination is not possible.





Example of order Modulplatte

LM	1	PCA	160
----	---	-----	-----

Lindab Formo a series of architectural designed diffusers

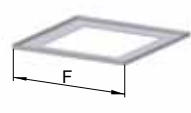
Ceiling tile adaption

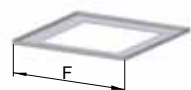
Details, see [Chapter ceiling tile adaption](#)

Product		Size	8	9	10	11	14	
Ceiling types			Ecophon Focus DG	Rockfon E10 24 Ecophon -E / T24	Rockfon E10 15 Ecophon -E / T15	Danotile Markant	Ecophon Focus edge DS	
Perforated - square		mm	F: 592mm	F: 575mm	F: 584 mm	F: 575 mm	F: 599 mm	
PKA		125	●	●	●	●	●	
		160	●	●	●	●	●	
		200	●	●	●	●	●	
		250	●	●	●	●	●	
		315	●	●	●	●	●	
400	●	●	●	●	●			
Perforated - circular		mm	F: 592mm	F: 575mm	F: 584 mm	F: 575 mm	F: 599 mm	
PCA		100	●	●	●	●	●	
		125	●	●	●	●	●	
		160	●	●	●	●	●	
		200	●	●	●	●	●	
		250	●	●	●	●	●	
		315	●	●	●	●	●	
		400	●	●	●	●	●	
Plain - square		mm	F: 592mm	F: 575mm	F: 584 mm	F: 575 mm	F: 599 mm	
LKA		125	●	●	●	●	●	
		160	●	●	●	●	●	
		200	●	●	●	●	●	
		250	●	●	●	●	●	
		315	●	●	●	●	●	
400	●	●	●	●	●			
Plain - circular		mm	F: 592mm	F: 575mm	F: 584 mm	F: 575 mm	F: 599 mm	
LCA		100	●	●	●	●	●	
		125	●	●	●	●	●	
		160	●	●	●	●	●	
		200	●	●	●	●	●	
		250	●	●	●	●	●	
		315	●	●	●	●	●	
		400	●	●	●	●	●	
Plain - circular		mm	F: 592mm	F: 575mm	F: 584 mm	F: 575 mm	F: 599 mm	
CRL		100						
		125						
		160						
		200						
		250						
		315						
		400						

- 1. Product and tech. data depicted in catalogue.
- 2. Combination possible. Tech. data depicted in catalogue.
- 3. Combination possible. Tech. data not in catalogue.
- 4. If space is empty, combination is not possible.

1
2
3
4
5
6
7
8
9
10
11
12
13
14
15
16
17
18

Perforated diffuser

PKA



Description

PKA is a square diffuser with perforated face plate. PKA can be used for both supply and exhaust air. PKA is suitable for horizontal supply of cooled air and can be equipped with accessories of various types in order to achieve optimal function. Installing a PKA diffuser in a plenum box type MBB can help to achieve a stable airflow to the diffuser as well as realise the potential for individual adjustment.

- Suitable for both supply and exhaust air
- Suitable for horizontal supply of cooled air
- Option of 1, 2 and 3-way supply air

Maintenance

The face plate can be removed to enable cleaning of internal parts or to gain access to the duct or box. The visible parts of the diffuser can be wiped with a damp cloth.

Order code

Product	PKA	aaa
Type	PKA	
Connection dim. Ød	Ød 125-400	

Example: PKA-200

Dimensions

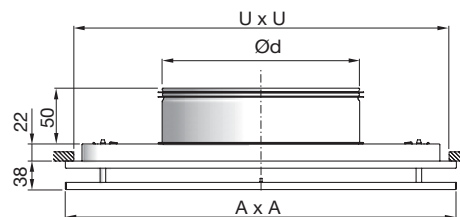

PKA Ød mm	A mm	U * mm	Free area A m ²	Weight kg
125	235	200	0,018	1,10
160	295	260	0,023	1,80
200	395	360	0,03	2,80
250	495	460	0,043	4,20
315	595	560	0,057	5,70
400	595	560	0,075	5,70

* U x U = Ceiling grid opening

Materials and finish

Material:	Galvanised steel
Standard finish:	Powder-coated
Standard colour:	White RAL 9010, gloss 30

The diffuser is available in other colours. Please contact Lindab's sales department for further information.

Perforated diffuser

PKA

Accessories

DRZ - Balancing damper

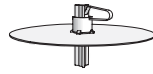
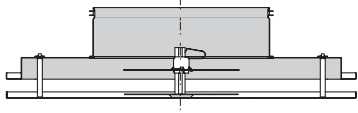

Blending profiles (set)

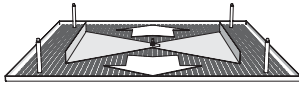
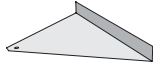
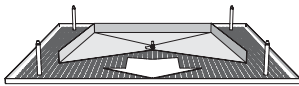

MBZ - Extension piece

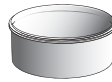

DKZ - Mounting brackets (set)

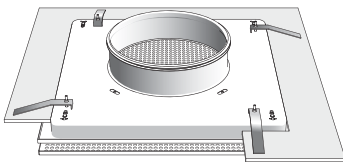
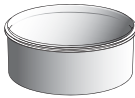

Order code - accessories

Product	aaa	bbb
Type		
Size		

Example: DRZ-200

LM - Module plate

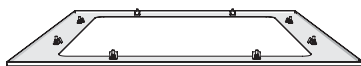

Order code - module plate

Product	LM	a	PKA	ccc
Type				
Ceiling system				
Diffuser				
Size				

Example: LM-1-PKA-200

Ceiling system - see introductory summary.

MBB - Plenum box



PKA + MBB

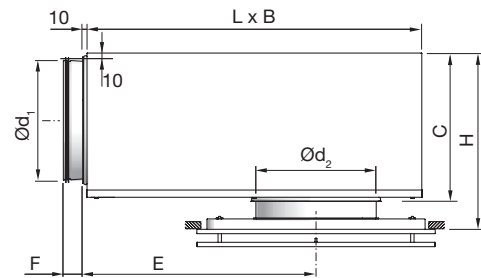

PKA + MBB		B mm	C mm	E mm	F mm	H* mm	L mm
duct Ød ₁ mm	PKA Ød ₂ mm						
100	125	260	159	216	50	180 - 220	310
100	160	260	159	216	50	180 - 220	310
125	125	310	184	262	50	205 - 245	376
125	160	310	184	262	50	205 - 245	376
125	200	310	184	262	50	205 - 245	376
160	160	380	220	323	50	239 - 279	459
160	200	380	220	323	50	239 - 279	459
160	250	380	220	323	50	239 - 279	459
200	200	460	259	396	70	280 - 320	565
200	250	460	259	396	70	280 - 320	565
200	315	460	259	396	70	280 - 320	565
250	250	540	309	486	70	330 - 370	698
250	315	540	309	486	70	330 - 370	698
250	400	540	309	486	70	330 - 370	698
315	315	540	373	646	70	395 - 435	858
315	400	540	373	646	70	395 - 435	858

* Using accessory MBZ the H dimension will increase:

Ød₂ = 125 - 200 mm => H +40 mm

Ød₂ = 250 - 315 mm => H +60 mm

Ød₂ = 400 mm => H +80 mm

Order code

Product	MBB	aaa	bbb	c
Type				
MBB				
Duct connection Ød ₁				
Ø100-315				
Diffuser dimension Ød ₂				
Ø125-400				
Function				
S = Supply air				
E = Exhaust				

Example: PKA-200+MBB-160-200-S

Perforated diffuser

PKA

Technical data

Capacity

Air flow q_v [l/s] and [m³/h], total pressure Δp_t [Pa], throw $l_{0,2}$ [m] and sound power level L_{WA} [dB(A)] can be seen in the diagrams.

Frequency-related sound effect level

The sound effect level in the frequency band is defined as $L_{WA} + K_{ok}$. K_{ok} values are specified in charts beneath the diagrams on the following pages.

Quick selection, supply air

PKA + MBB		$\Delta p_t \geq 50$ Pa 30 dB(A)		$\Delta p_t \geq 50$ Pa 35 dB(A)	
duct	PKA	l/s	m ³ /h	l/s	m ³ /h
$\varnothing d_1$	$\varnothing d_2$				
100	125	33	119	39	140
100	160	39	140	47	169
125	125	40	144	48	173
125	160	51	184	61	220
125	200	58	209	70	252
160	160	59	212	70	252
160	200	67	241	84	302
160	250	77	277	99	356
200	200	83	299	100	360
200	250	96	346	118	425
200	315	112	403	139	500
250	250	118	425	139	500
250	315	133	479	163	587
250	400	128	461	174	626
315	315	145	522	173	623
315	400	173	623	209	752

Sound attenuation

Sound attenuation of the diffuser ΔL from duct to room, including end reflection, see table below.

PKA + MBB		Centre frequency Hz							
duct	PKA	63	125	250	500	1K	2K	4K	8K
$\varnothing d_1$	$\varnothing d_2$								
100	125	19	16	7	19	18	18	18	21
100	160	21	16	5	15	17	18	16	19
125	125	18	13	9	20	13	19	18	19
125	160	12	13	8	19	13	16	17	19
125	200	16	11	5	16	13	15	15	17
160	160	17	17	11	19	18	17	20	20
160	200	14	14	7	21	15	16	18	19
160	250	15	15	5	17	13	15	16	18
200	200	15	10	6	16	17	15	19	18
200	250	12	9	5	14	17	15	17	17
200	315	12	7	4	11	15	14	16	15
250	250	14	8	8	14	16	17	17	18
250	315	12	6	6	15	15	15	16	17
250	400	13	5	4	13	14	14	15	15
315	315	7	9	8	14	17	16	17	21
315	400	7	8	8	12	16	16	16	18

Balancing

Balancing data is contained in a separate brochure.

Throw $l_{0,2}$

The throw is specified at a terminal velocity of 0.2 m/s.

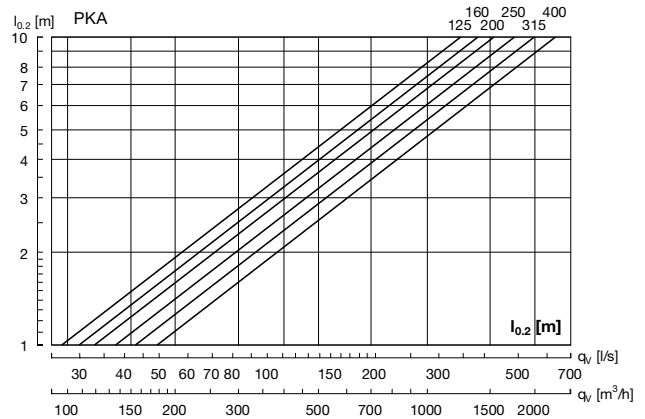

Correction throw $l_{0,2}$

PKA $\varnothing d$	1 - ways	2 - ways	3 - ways
125	2.6	1.8	1.4
160	2.5	1.7	1.3
200	2.4	1.7	1.3
250	2.3	1.7	1.3
315	2.2	1.7	1.2
400	2.3	1.7	1.2

Air jet distribution

l_b = Distance from the diffuser to the point where there is maximum dispersal.

b_v = Depth of the air jet on a vertical plane.

b_h = Width of the air jet on a horizontal plane.

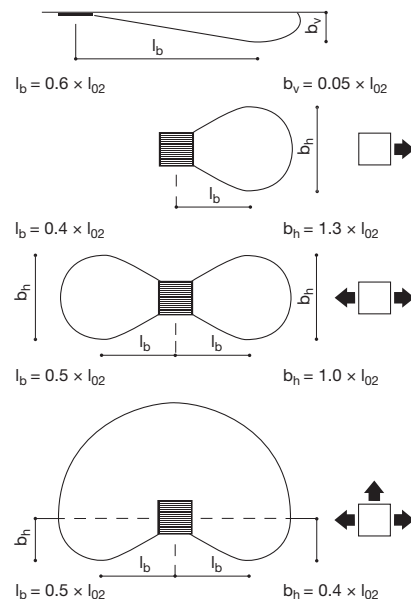

Perforated diffuser

PKA

Technical data

PKA without box - Supply air

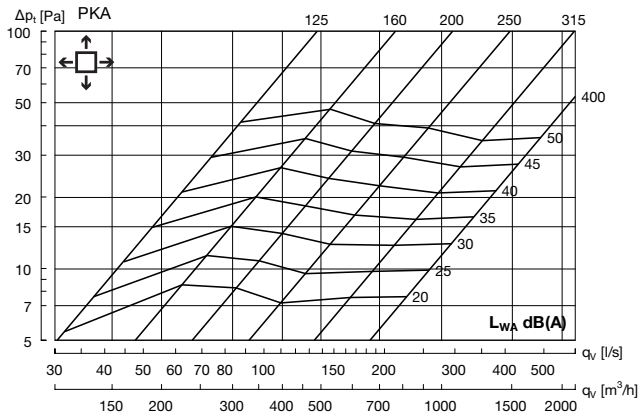

PKA 125 + MBB - Supply air

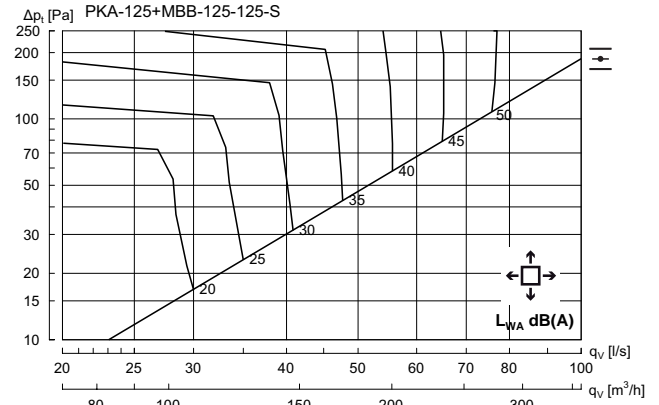

Hz	63	125	250	500	1K	2K	4K	8K
K _{uk}	9	5	-1	-4	-3	-11	-20	-26

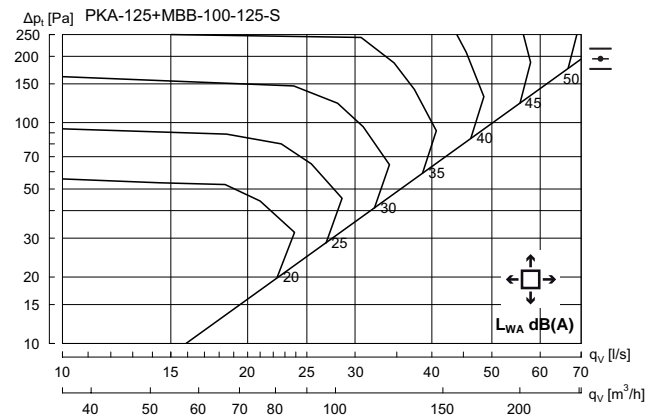

Hz	63	125	250	500	1K	2K	4K	8K
K _{uk}	11	7	3	-5	-5	-11	-18	-25

- 1
- 2
- 3
- 4
- 5
- 6
- 7
- 8
- 9
- 10
- 11
- 12
- 13
- 14
- 15
- 16
- 17
- 18

Perforated diffuser

PKA

Technical data

PKA 160 + MBB - Supply air

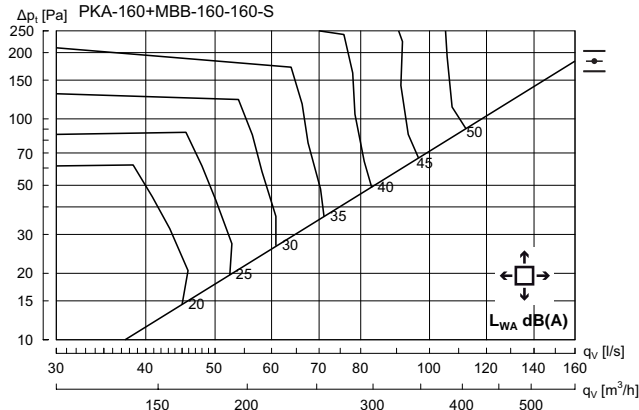

Hz	63	125	250	500	1K	2K	4K	8K
K_{ok}	8	5	-2	-4	-3	-11	-21	-29

PKA 200 + MBB - Supply air

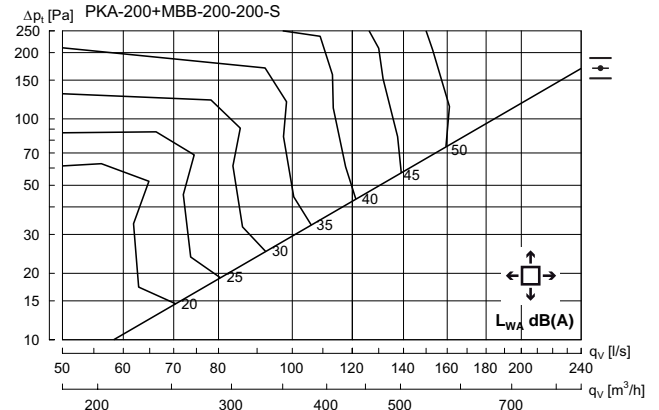

Hz	63	125	250	500	1K	2K	4K	8K
K_{ok}	11	5	-3	-3	-3	-11	-22	-29

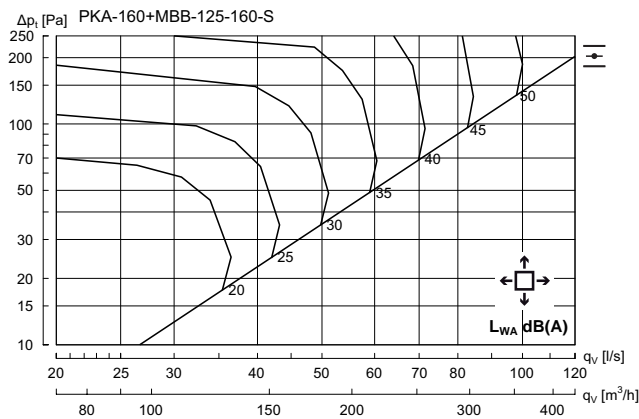

Hz	63	125	250	500	1K	2K	4K	8K
K_{ok}	9	5	1	-4	-4	-10	-17	-25

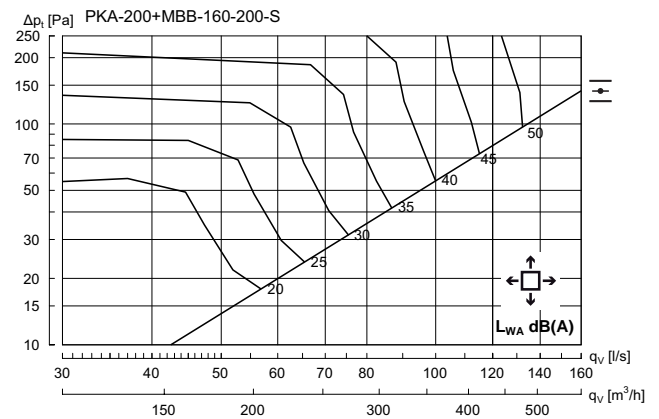

Hz	63	125	250	500	1K	2K	4K	8K
K_{ok}	10	5	-2	-4	-3	-10	-20	-26

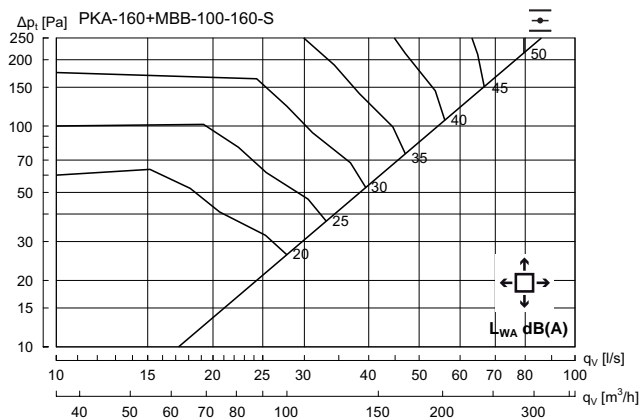

Hz	63	125	250	500	1K	2K	4K	8K
K_{ok}	9	4	1	-3	-5	-10	-15	-19

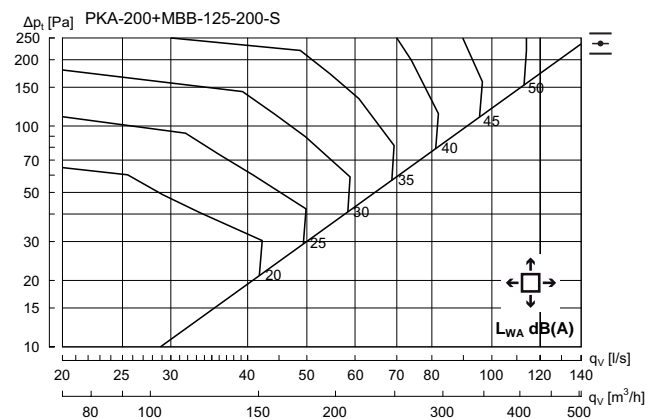

Hz	63	125	250	500	1K	2K	4K	8K
K_{ok}	10	5	1	-4	-5	-10	-15	-22

Perforated diffuser

PKA

Technical data

PKA 250 + MBB - Supply air

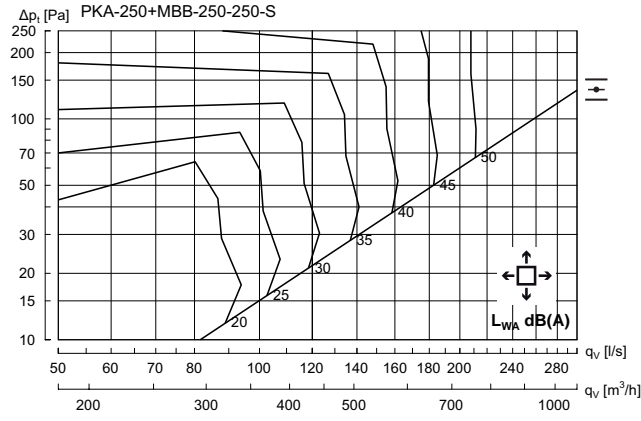

Hz	63	125	250	500	1K	2K	4K	8K
K_{ok}	11	3	-4	-3	-3	-12	-22	-30

PKA 315 + MBB - Supply air

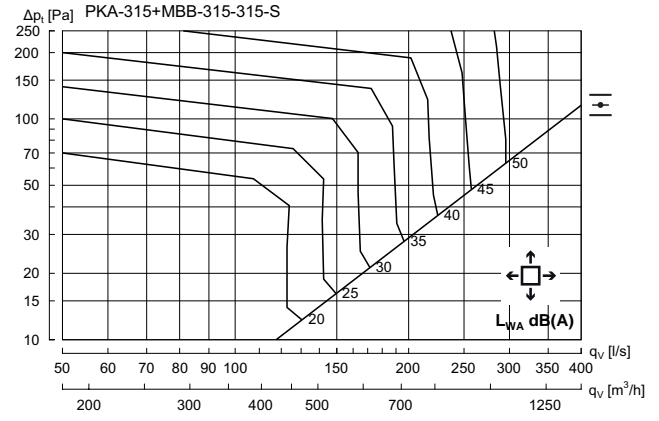

Hz	63	125	250	500	1K	2K	4K	8K
K_{ok}	12	2	-3	-2	-3	-13	-23	-33

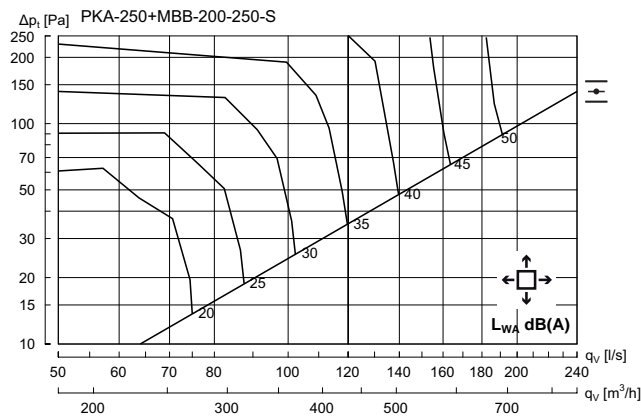

Hz	63	125	250	500	1K	2K	4K	8K
K_{ok}	10	5	-2	-3	-3	-11	-20	-28

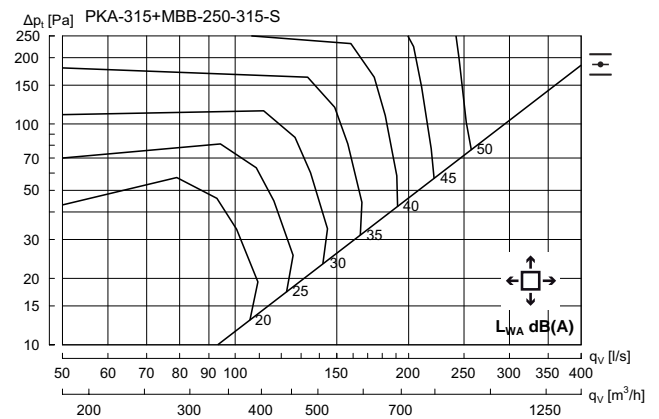

Hz	63	125	250	500	1K	2K	4K	8K
K_{ok}	11	3	-2	-3	-4	-11	-18	-27

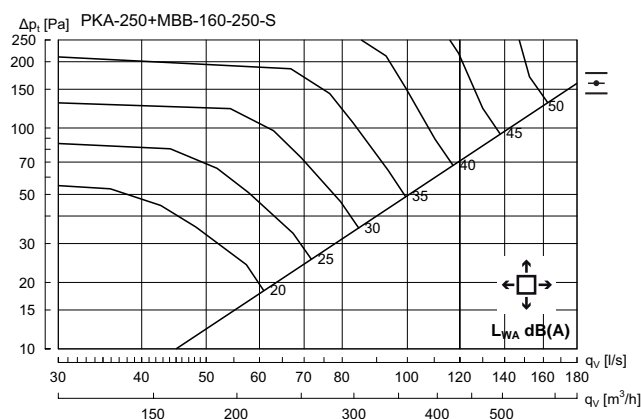

Hz	63	125	250	500	1K	2K	4K	8K
K_{ok}	8	5	0	-4	-4	-10	-17	-23

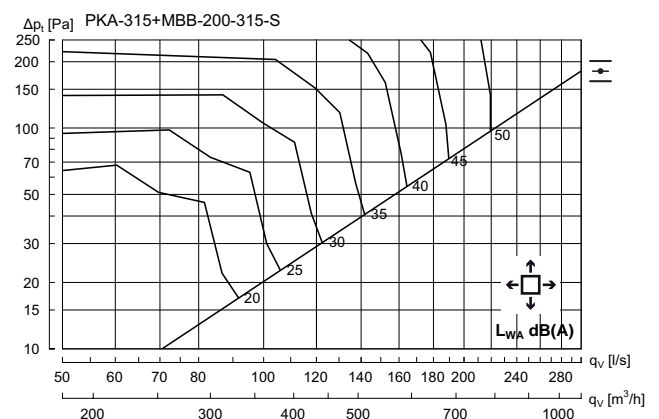

Hz	63	125	250	500	1K	2K	4K	8K
K_{ok}	10	5	-1	-3	-4	-11	-19	-25

Perforated diffuser

PKA

Technical data

PKA 400 + MBB - Supply air

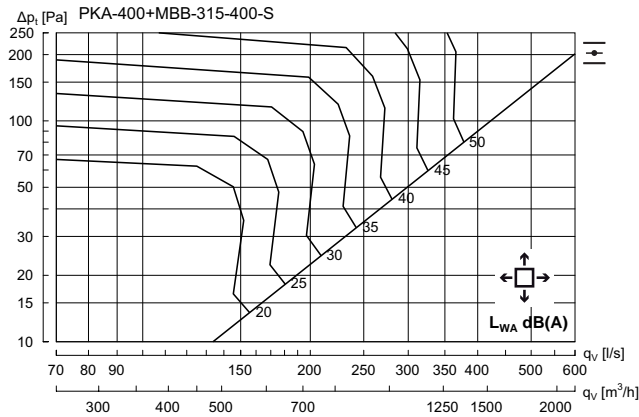

Hz	63	125	250	500	1K	2K	4K	8K
K_{sk}	14	2	0	-2	-5	-13	-17	-26

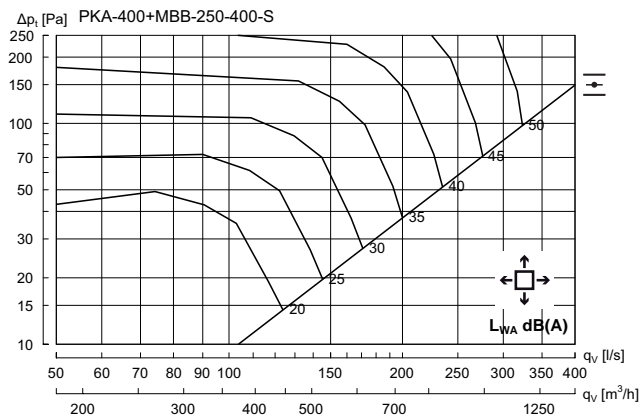

Hz	63	125	250	500	1K	2K	4K	8K
K_{sk}	10	4	0	-2	-4	-11	-17	-24

PKA + MBB - Supply air

Correction sound power level (L_{WA}) and pressure loss (Δp_t)

PKA + MBB		1 - ways		2 - ways		3 - ways	
duct	PKA	L_{WA}	Δp_t	L_{WA}	Δp_t	L_{WA}	Δp_t
100	125	+ 10	x 1.3	+ 4	x 1.1	+ 2	x 1.05
100	160	+ 5	x 1.1	+ 2	x 1.05	+ 1	x 1
125	125	+ 10	x 1,35	+ 6	x 1,1	+ 4	x 1,05
125	160	+ 10	x 1.4	+ 4	x 1.1	+ 1	x 1
125	200	+ 4	x 1.2	+ 2	x 1.05	+ 1	x 1
160	160	+ 13	x 1.8	+ 6	x 1.3	+ 2	x 1.1
160	200	+ 16	x 1.7	+ 10	x 1.2	+ 4	x 1.05
160	250	+ 10	x 1.3	+ 6	x 1,1	+ 3	x 1
200	200	+ 17	x 2.3	+ 11	x 1.4	+ 7	x 1.1
200	250	+ 13	x 1.8	+ 6	x 1.2	+ 4	x 1.1
200	315	+ 9	x 1.5	+ 4	x 1.1	+ 0	x 1.05
250	250	+ 21	x 2.1	+ 11	x 1.4	+ 7	x 1.2
250	315	+ 19	x 1.8	+ 7	x 1.2	+ 3	x 1.1
250	400	+ 10	x 1.5	+ 6	x 1.2	+ 0	x 1
315	315	+ 21	x 2.1	+ 10	x 1.3	+ 4	x 1.1
315	400	+ 21	x 1.8	+ 8	x 1.5	+ 3	x 1.2



Perforated diffuser

PKA

Technical data

PKA without box - Exhaust air

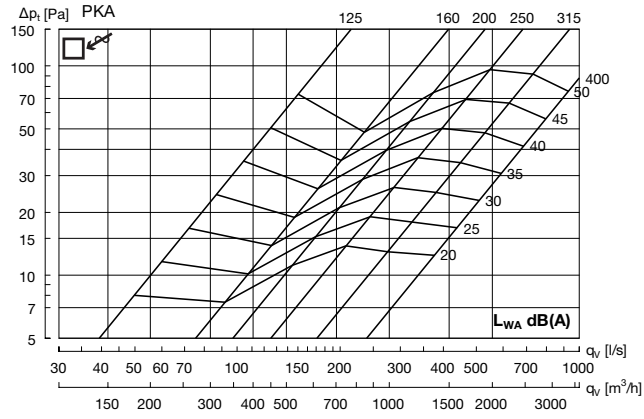

PKA 125 + MBB - Exhaust air

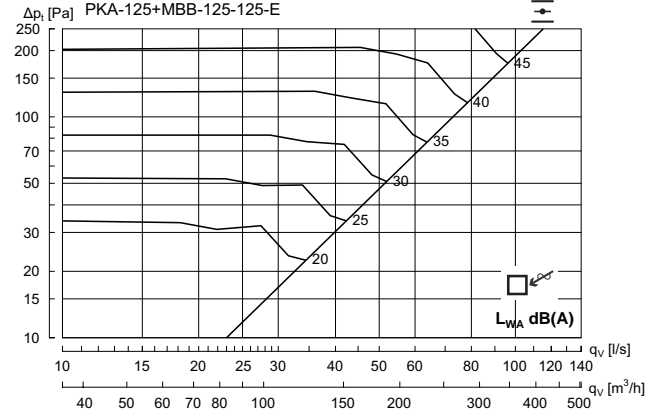

Hz	63	125	250	500	1K	2K	4K	8K
K_{uk}	13	5	-1	-4	-4	-11	-15	-20

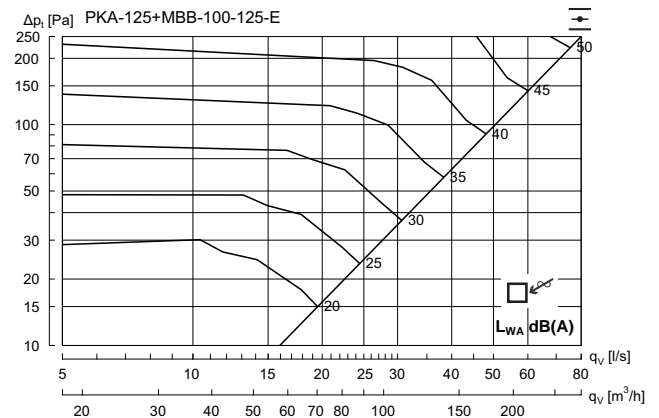

Hz	63	125	250	500	1K	2K	4K	8K
K_{uk}	13	-1	3	-3	-6	-10	-16	-19

- 1
- 2
- 3
- 4
- 5
- 6
- 7
- 8
- 9
- 10
- 11
- 12
- 13
- 14
- 15
- 16
- 17
- 18

Perforated diffuser

PKA

Technical data

PKA 160 + MBB - Exhaust air

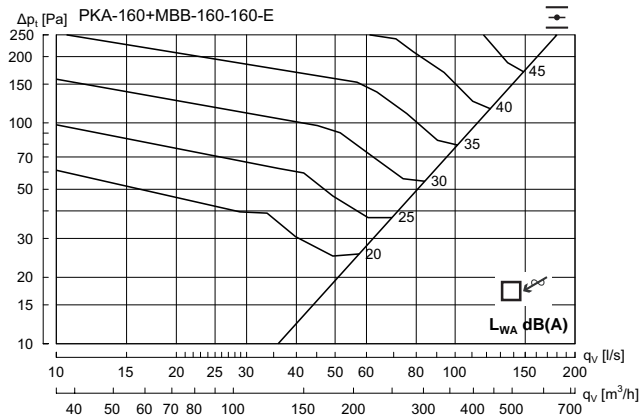

Hz	63	125	250	500	1K	2K	4K	8K
K_{ok}	16	6	-1	-5	-4	-10	-15	-19

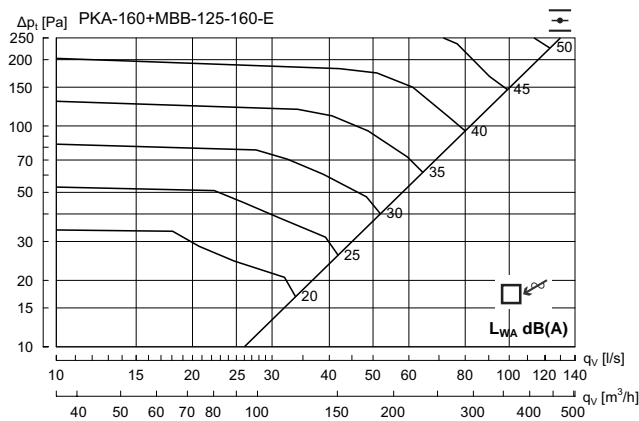

Hz	63	125	250	500	1K	2K	4K	8K
K_{ok}	13	5	0	-3	-5	-11	-15	-22

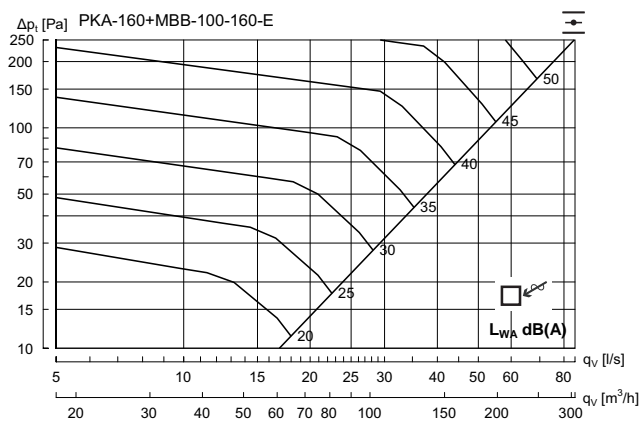

Hz	63	125	250	500	1K	2K	4K	8K
K_{ok}	10	-1	5	-3	-8	-11	-18	-25

PKA 200 + MBB - Exhaust air

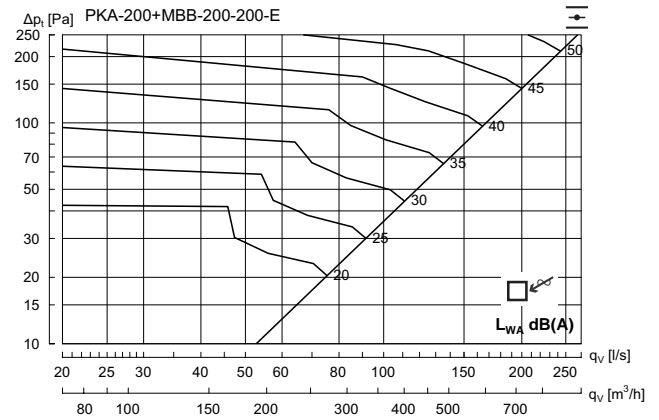

Hz	63	125	250	500	1K	2K	4K	8K
K_{ok}	15	4	-1	-4	-5	-9	-16	-25

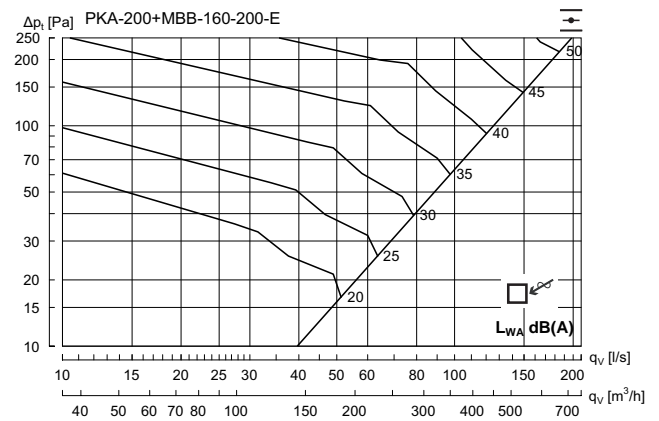

Hz	63	125	250	500	1K	2K	4K	8K
K_{ok}	15	6	-1	-5	-5	-9	-14	-20

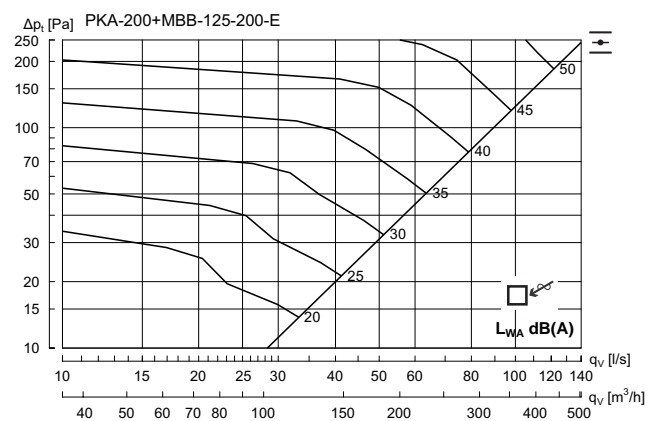

Hz	63	125	250	500	1K	2K	4K	8K
K_{ok}	9	3	1	-4	-5	-10	-14	-21

Perforated diffuser

PKA

Technical data

PKA 250 + MBB - Exhaust air

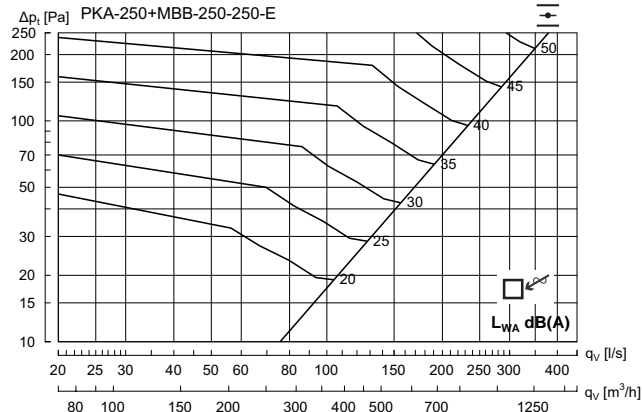

Hz	63	125	250	500	1K	2K	4K	8K
K_{ok}	10	5	2	-3	-5	-11	-16	-25

PKA 315 + MBB - Exhaust air

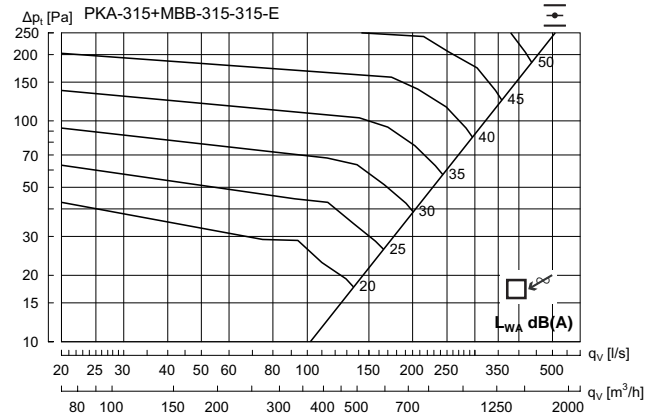

Hz	63	125	250	500	1K	2K	4K	8K
K_{ok}	13	5	3	-4	-6	-10	-16	-26

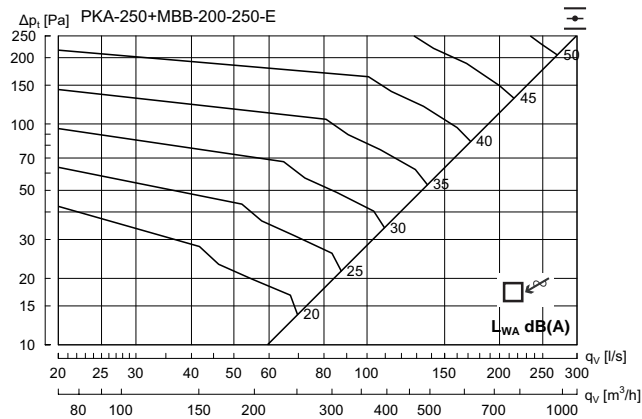

Hz	63	125	250	500	1K	2K	4K	8K
K_{ok}	12	5	0	-3	-5	-10	-14	-23

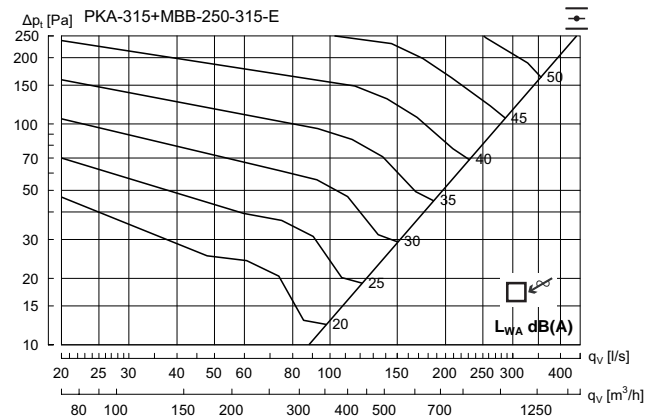

Hz	63	125	250	500	1K	2K	4K	8K
K_{ok}	7	5	2	-3	-6	-10	-16	-24

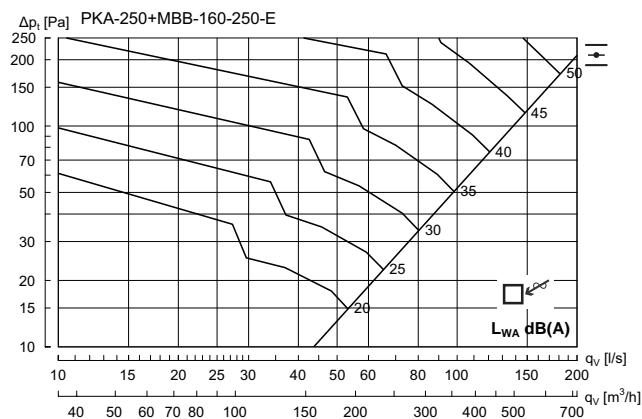

Hz	63	125	250	500	1K	2K	4K	8K
K_{ok}	16	6	0	-5	-5	-9	-15	-21

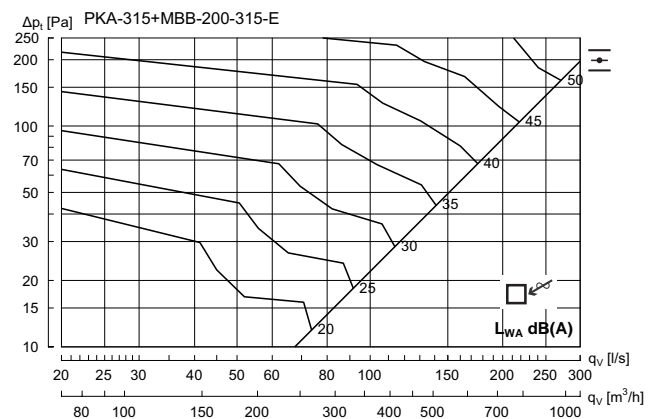

Hz	63	125	250	500	1K	2K	4K	8K
K_{ok}	13	5	0	-3	-5	-9	-15	-23

Perforated diffuser

PKA

Technical data

PKA 400 + MBB - Exhaust air

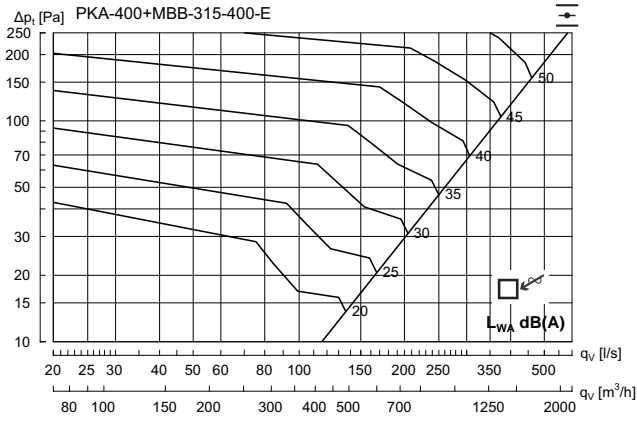

Hz	63	125	250	500	1K	2K	4K	8K
K_{sk}	10	4	2	-3	-6	-9	-14	-25

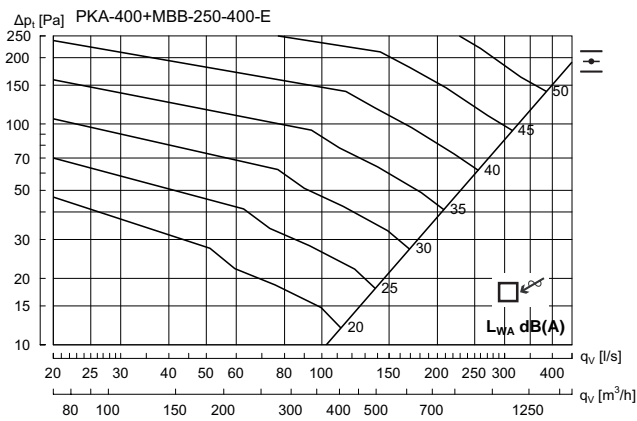

Hz	63	125	250	500	1K	2K	4K	8K
K_{sk}	10	5	2	-4	-5	-10	-15	-23

- 1
- 2
- 3
- 4
- 5
- 6
- 7
- 8
- 9
- 10
- 11
- 12
- 13
- 14
- 15
- 16
- 17
- 18

Perforated diffuser

PCA



Description

PCA is a circular diffuser with perforated face plate. PCA can be used for both supply and exhaust air. PCA is suitable for horizontal supply of cooled air and can be equipped with accessories of various types in order to achieve optimal function. Installing a PCA diffuser in a plenum box type MBB can help to achieve a stable airflow to the diffuser as well as realise the potential for individual adjustment.

- Suitable for both supply and exhaust air
- Suitable for horizontal supply of cooled air
- Option of 1, 2 and 3-way supply air

Maintenance

The face plate can be removed to enable cleaning of internal parts or to gain access to the duct or box. The visible parts of the diffuser can be wiped with a damp cloth.

Dimensions

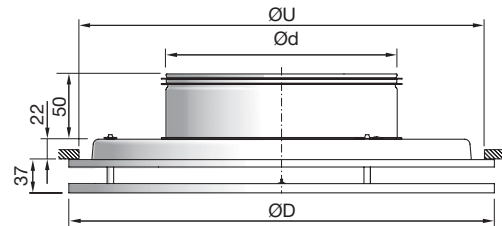

PCA Ød mm	ØD mm	ØU* mm	Free area A m ²	Weight kg
100	240	200	0.016	1,00
125	240	200	0.018	1,00
160	300	260	0.023	1,50
200	360	320	0.03	2,30
250	460	420	0.042	3,40
315	540	500	0.058	4,60
400	540	500	0.066	4,60

* ØU = Ceiling grid opening

Order code

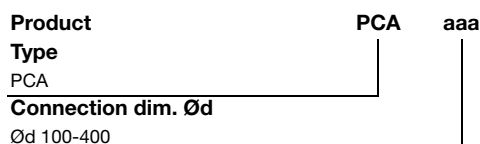

Example: PCA-200

Materials and finish

Material: Galvanised steel
 Standard finish: Powder-coated
 Standard colour: White RAL 9010, gloss 30

The diffuser is available in other colours. Please contact Lindab's sales department for further information.



Perforated diffuser

PCA

Accessories

DRZ - Balancing damper

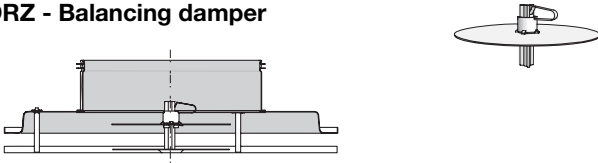

Blending profiles (set)

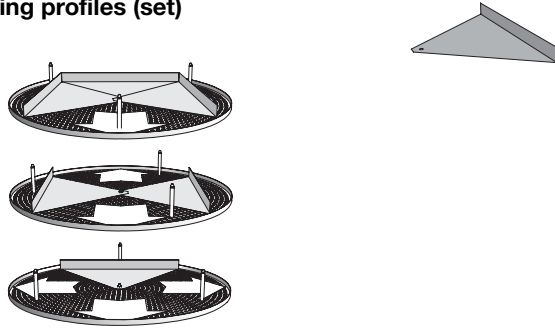

MBZ - Extension piece

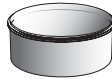

DDZ - Mounting brackets (set)

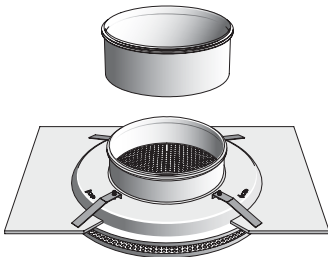

Order code - accessories

Product aaa bbb
 Type _____
 Size _____

Example: DRZ-200

LM - Module plate

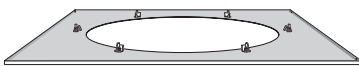

Order code - module plate

Product LM a PCA ccc
 Type _____
 Ceiling system _____
 Diffuser _____
 Size _____

Example: LM-1-PCA-200

Ceiling system - see introductory summary.

MBB - Plenum box



PCA + MBB

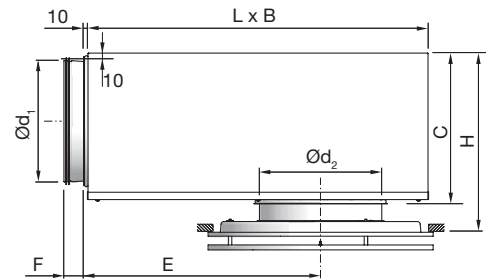

PCA + MBB		B mm	C mm	E mm	F mm	H* mm	L mm
duct Ød ₁ mm	PCA Ød ₂ mm						
100	100	260	159	216	50	180 - 220	310
100	125	260	159	216	50	180 - 220	310
100	160	260	159	216	50	180 - 220	310
125	125	310	184	262	50	205 - 245	376
125	160	310	184	262	50	205 - 245	376
125	200	310	184	262	50	205 - 245	376
160	160	380	220	323	50	239 - 279	459
160	200	380	220	323	50	239 - 279	459
160	250	380	220	323	50	239 - 279	459
200	200	460	259	396	70	280 - 320	565
200	250	460	259	396	70	280 - 320	565
200	315	460	259	396	70	280 - 320	565
250	250	540	309	486	70	330 - 370	698
250	315	540	309	486	70	330 - 370	698
250	400	540	309	486	70	330 - 370	698
315	315	540	373	646	70	395 - 435	858
315	400	540	373	646	70	395 - 435	858

* Using accessory MBZ the H dimension will increase:

Ød₂ = 100 - 200 mm => H +40 mm

Ød₂ = 250 - 315 mm => H +60 mm

Ød₂ = 400 mm => H +80 mm

Order code

Product MBB aaa bbb c
 Type _____
 MBB _____
 Duct connection Ød₁ _____
 Ø100-315 _____
 Diffuser dimension Ød₂ _____
 Ø100-400 _____
 Function _____
 S = Supply air _____
 E = Exhaust _____

Example: PCA-200+MBB-160-200-S

Perforated diffuser

PCA

Technical data

Capacity

Air flow q_v [l/s] and [m³/h], total pressure Δp_t [Pa], throw $l_{0.2}$ [m] and sound power level L_{WA} [dB(A)] can be seen in the diagrams

Frequency-related sound effect level

The sound effect level in the frequency band is defined as $L_{WA} + K_{Ok}$. K_{Ok} values are specified in charts beneath the diagrams on the following pages.

Quick selection, supply air

PCA + MBB		$\Delta p_t \geq 50$ Pa 30 dB(A)		$\Delta p_t \geq 50$ Pa 35 dB(A)	
duct $\varnothing d_1$	PCA $\varnothing d_2$	l/s	m ³ /h	l/s	m ³ /h
100	100	26	94	31	112
100	125	33	119	39	140
100	160	39	140	47	169
125	125	40	144	48	173
125	160	51	184	61	220
125	200	58	209	70	252
160	160	57	207	71	255
160	200	67	241	84	302
160	250	77	277	99	356
200	200	83	299	100	360
200	250	96	346	118	425
200	315	112	403	139	500
250	250	118	425	139	500
250	315	133	479	163	587
250	400	146	526	193	695
315	315	145	522	173	623
315	400	187	673	225	810

Sound attenuation

Sound attenuation of the diffuser ΔL from duct to room, including end reflection, see table below.

PCA + MBB		Centre frequency Hz							
duct $\varnothing d_1$	PCA $\varnothing d_2$	63	125	250	500	1K	2K	4K	8K
100	100	18	17	8	20	19	20	19	23
100	125	19	16	7	19	18	18	18	21
100	160	21	16	5	15	17	18	16	19
125	125	18	13	9	20	13	19	18	19
125	160	12	13	8	19	13	16	17	19
125	200	16	11	5	16	13	15	15	17
160	160	17	17	11	19	18	17	20	20
160	200	14	14	7	21	15	16	18	19
160	250	15	15	5	17	13	15	16	18
200	200	15	10	6	16	17	15	19	18
200	250	12	9	5	14	17	15	17	17
200	315	12	7	4	11	15	14	16	15
250	250	14	8	8	14	16	17	17	18
250	315	12	6	6	15	15	15	16	17
250	400	13	5	4	13	14	14	15	15
315	315	7	9	8	14	17	16	17	21
315	400	7	8	8	12	16	16	16	18

Balancing

Balancing data is contained in a separate brochure.

Throw $l_{0.2}$

The throw is specified at a terminal velocity of 0.2 m/s.

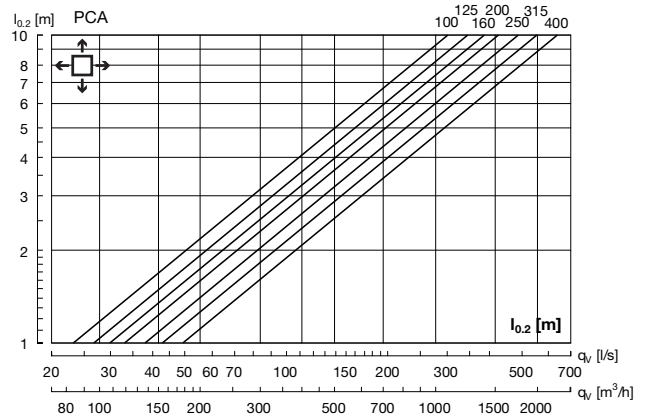

Correction throw $L_{0.2}$

PCA $\varnothing d$	1 - ways	2 - ways	3 - ways
100	2.3	1.7	1.3
125	2.6	1.8	1.4
160	2.5	1.7	1.3
200	2.4	1.7	1.3
250	2.3	1.7	1.3
315	2.2	1.7	1.2
400	2.3	1.7	1.2

Air jet distribution

l_b = Distance from the diffuser to the point where there is maximum dispersal.

b_v = Depth of the air jet on a vertical plane.

b_h = Width of the air jet on a horizontal plane.

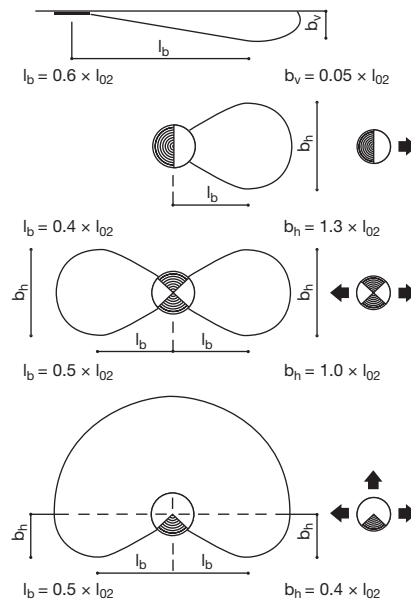

Perforated diffuser

PCA

Technical data

PCA without box - supply air

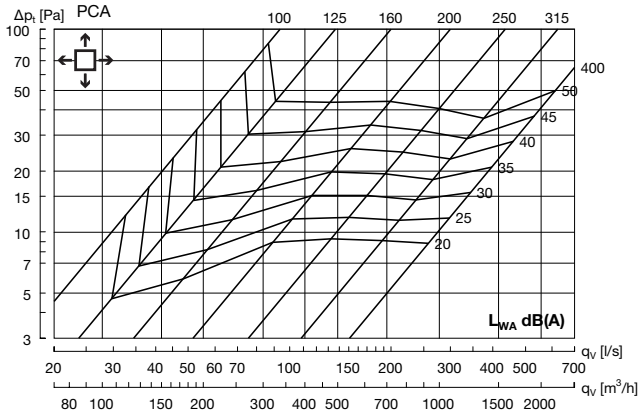

PCA 100 + MBB - Supply air

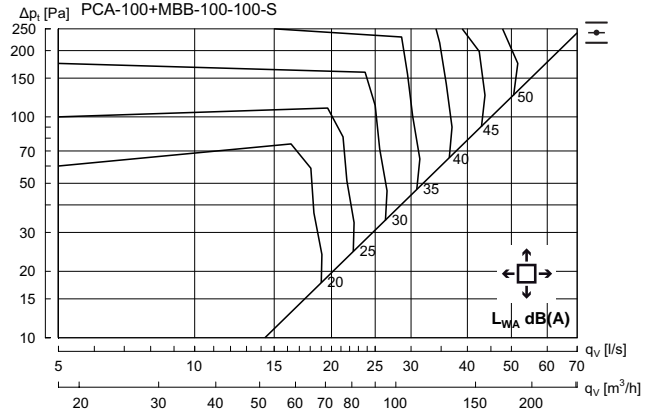

Hz	63	125	250	500	1K	2K	4K	8K
K_{ok}	12	5	2	-5	-4	-11	-20	-26

Perforated diffuser

PCA

Technical data

PCA 125 + MBB - Supply air

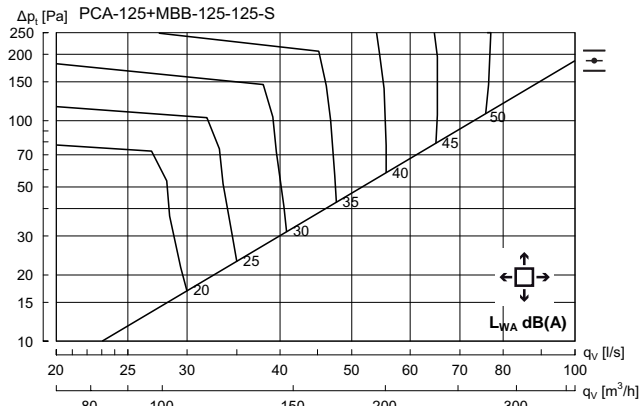

Hz	63	125	250	500	1K	2K	4K	8K
K_{ok}	9	5	-1	-4	-3	-11	-20	-26

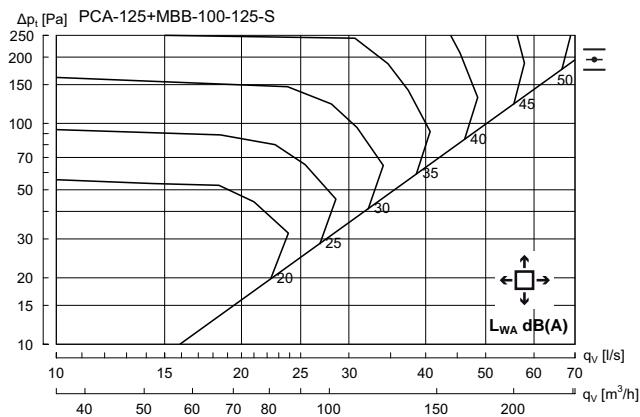

Hz	63	125	250	500	1K	2K	4K	8K
K_{ok}	11	7	3	-5	-5	-11	-18	-25

PCA 160 + MBB - Supply air

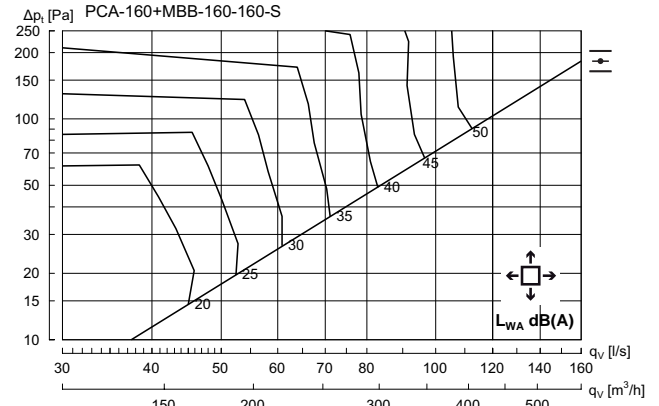

Hz	63	125	250	500	1K	2K	4K	8K
K_{ok}	8	5	-2	-4	-3	-11	-21	-29

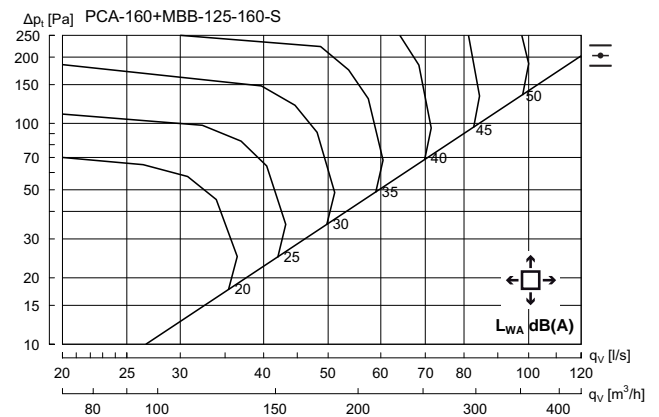

Hz	63	125	250	500	1K	2K	4K	8K
K_{ok}	9	5	1	-4	-4	-10	-17	-25

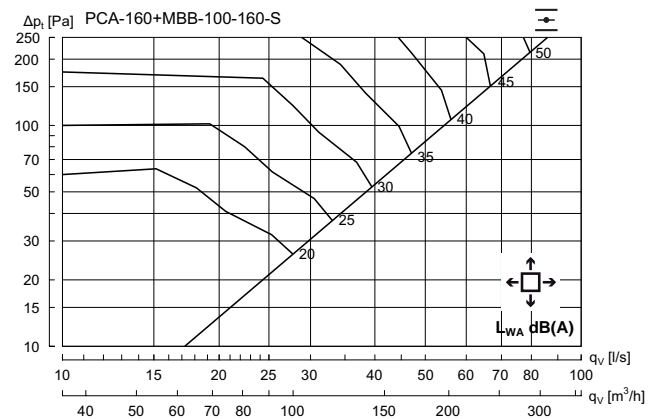

Hz	63	125	250	500	1K	2K	4K	8K
K_{ok}	9	4	1	-3	-5	-10	-15	-19

Perforated diffuser

PCA

Technical data

PCA 200 + MBB - Supply air

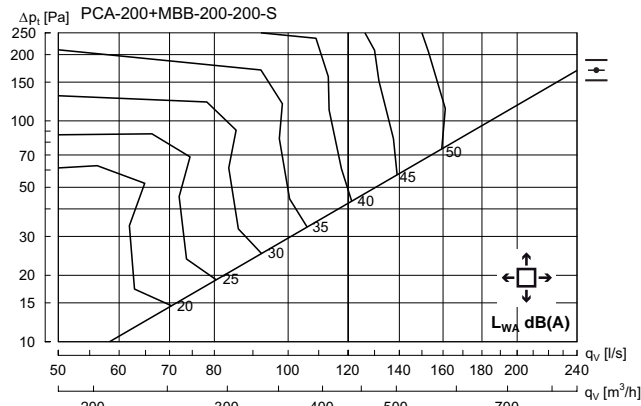

Hz	63	125	250	500	1K	2K	4K	8K
K_{ok}	11	5	-3	-3	-3	-11	-22	-29

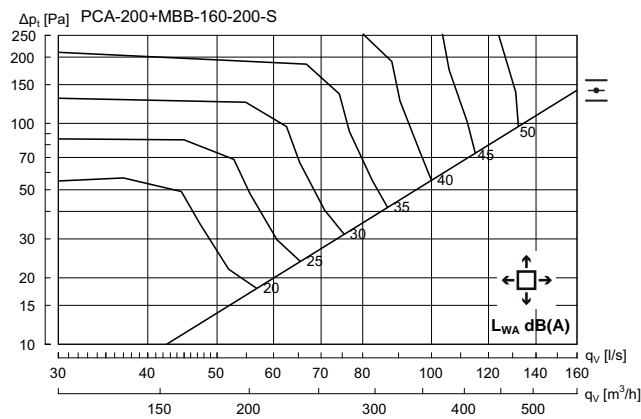

Hz	63	125	250	500	1K	2K	4K	8K
K_{ok}	10	5	-2	-4	-3	-10	-20	-26

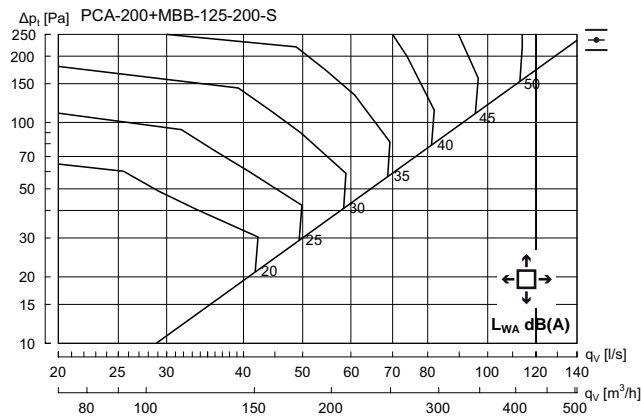

Hz	63	125	250	500	1K	2K	4K	8K
K_{ok}	10	5	1	-4	-5	-10	-15	-22

PCA 250 + MBB - Supply air

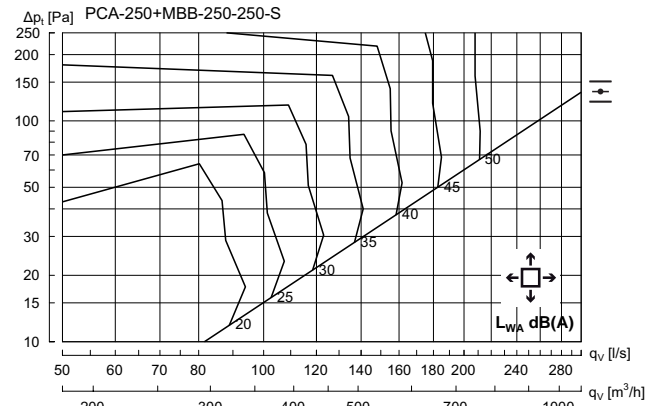

Hz	63	125	250	500	1K	2K	4K	8K
K_{ok}	11	3	-4	-3	-3	-12	-22	-30

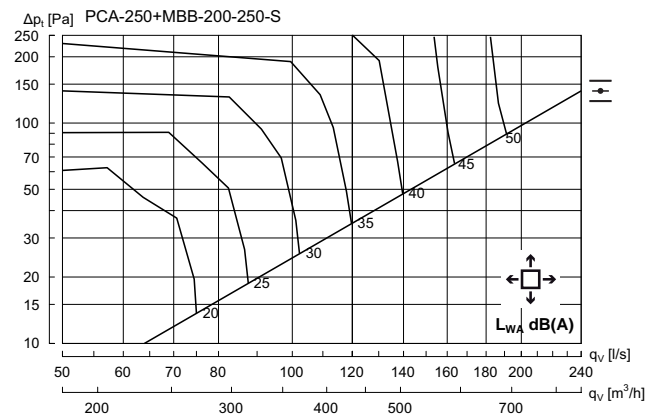

Hz	63	125	250	500	1K	2K	4K	8K
K_{ok}	10	5	-2	-3	-3	-11	-20	-28

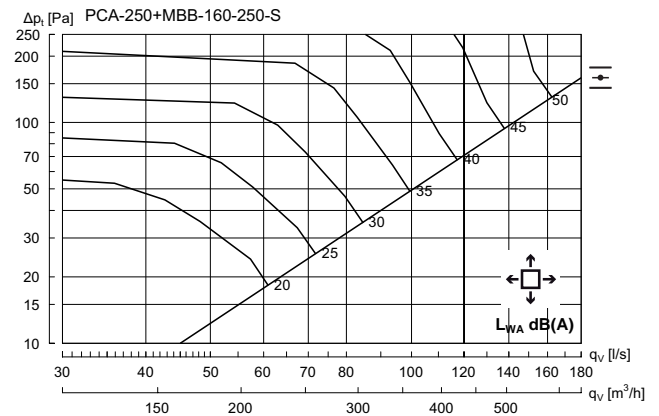

Hz	63	125	250	500	1K	2K	4K	8K
K_{ok}	8	5	0	-4	-4	-10	-17	-23

Perforated diffuser

PCA

Technical data

PCA 315 + MBB - Supply air

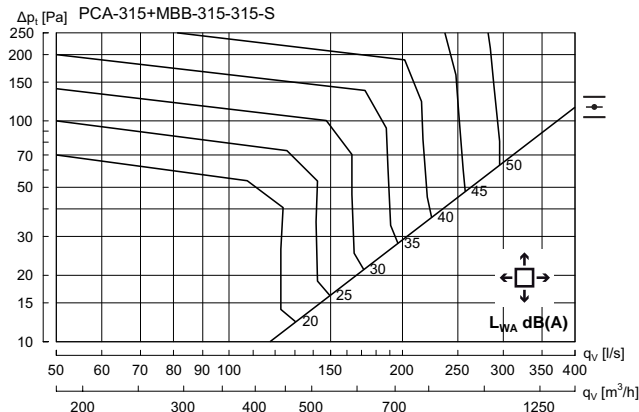

Hz	63	125	250	500	1K	2K	4K	8K
K_{ok}	12	2	-3	-2	-3	-13	-23	-33

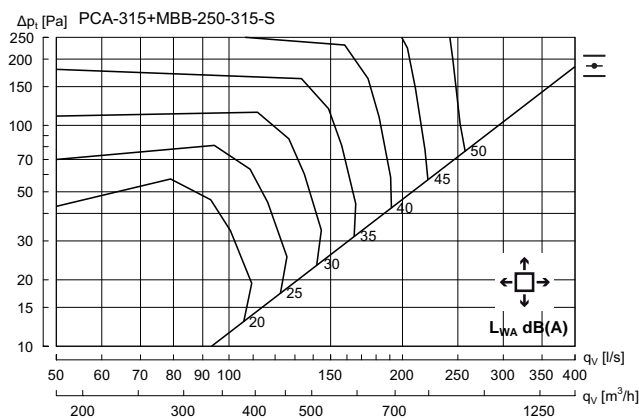

Hz	63	125	250	500	1K	2K	4K	8K
K_{ok}	11	3	-2	-3	-4	-11	-18	-27

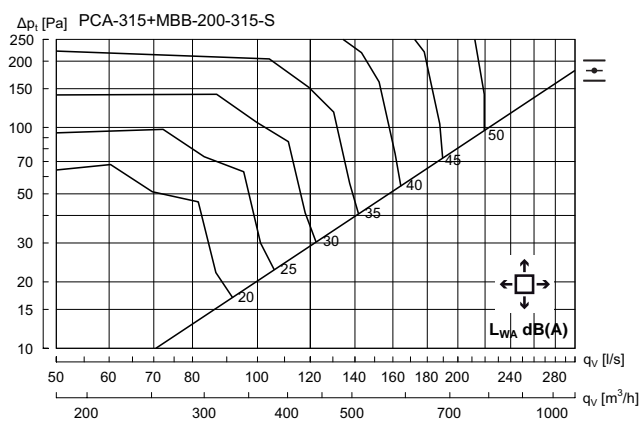

Hz	63	125	250	500	1K	2K	4K	8K
K_{ok}	10	5	-1	-3	-4	-11	-19	-25

PCA 400 + MBB - Supply air

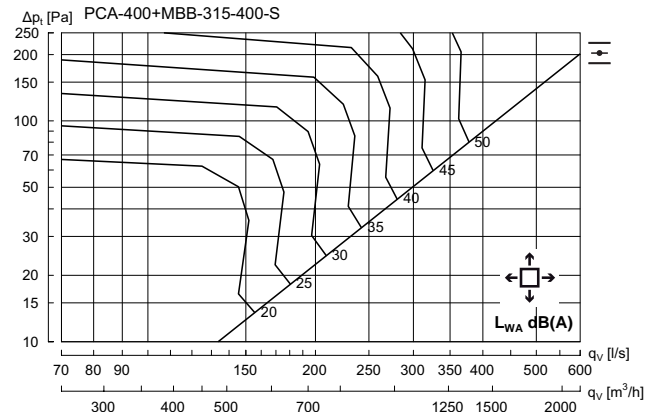

Hz	63	125	250	500	1K	2K	4K	8K
K_{ok}	14	2	0	-2	-5	-13	-17	-26

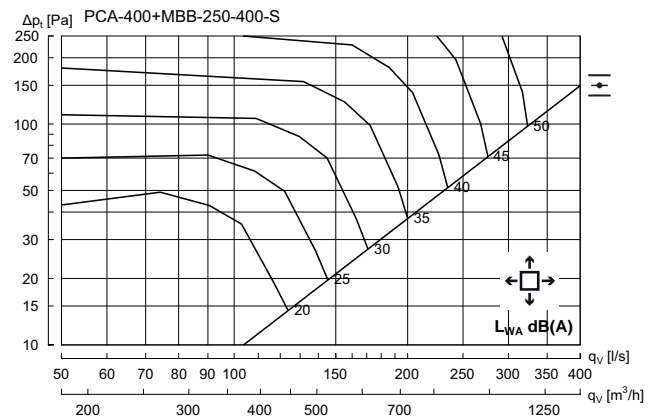

Hz	63	125	250	500	1K	2K	4K	8K
K_{ok}	10	4	0	-2	-4	-11	-17	-24

Correction sound power level (L_{WA}) and pressure loss (ΔP_t)

PCA + MBB		1 - ways		2 - ways		3 - ways	
duct	PCA	L_{WA}	ΔP_t	L_{WA}	ΔP_t	L_{WA}	ΔP_t
$\text{Ø}d_1$	$\text{Ø}d_2$						
100	100	+ 10	x 1,35	+ 6	x 1,1	+ 4	x 1,05
100	125	+ 10	x 1,3	+ 4	x 1,1	+ 2	x 1,05
100	160	+ 5	x 1,1	+ 2	x 1,05	+ 1	x 1
125	125	+ 10	x 1,35	+ 6	x 1,1	+ 4	x 1,05
125	160	+ 10	x 1,4	+ 4	x 1,1	+ 1	x 1
125	200	+ 4	x 1,2	+ 2	x 1,05	+ 1	x 1
160	160	+ 13	x 1,8	+ 6	x 1,3	+ 2	x 1,1
160	200	+ 16	x 1,7	+ 10	x 1,2	+ 4	x 1,05
160	250	+ 10	x 1,3	+ 6	x 1,1	+ 3	x 1
200	200	+ 17	x 2,3	+ 11	x 1,4	+ 7	x 1,1
200	250	+ 13	x 1,8	+ 6	x 1,2	+ 4	x 1,1
200	315	+ 9	x 1,5	+ 4	x 1,1	+ 0	x 1,05
250	250	+ 21	x 2,1	+ 11	x 1,4	+ 7	x 1,2
250	315	+ 19	x 1,8	+ 7	x 1,2	+ 3	x 1,1
250	400	+ 10	x 1,5	+ 6	x 1,2	+ 0	x 1
315	315	+ 21	x 2,1	+ 10	x 1,3	+ 4	x 1,1
315	400	+ 21	x 1,8	+ 8	x 1,5	+ 3	x 1,2

Perforated diffuser

PCA

Technical data

PCA without box - Exhaust air

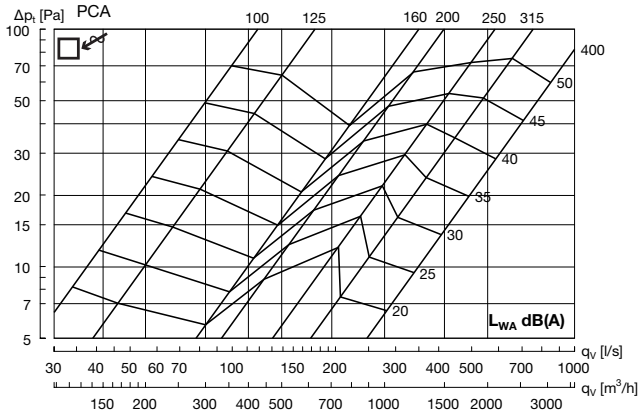

PCA 100 + MBB - Exhaust air

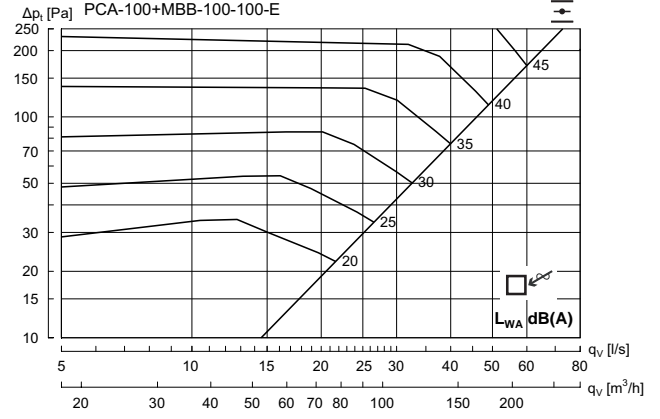

Hz	63	125	250	500	1K	2K	4K	8K
K_{ok}	11	0	3	-3	-6	-10	-15	-22

1

2

3

4

5

6

7

8

9

10

11

12

13

14

15

16

17

18

Perforated diffuser

PCA

Technical data

PCA 125 + MBB - Exhaust air

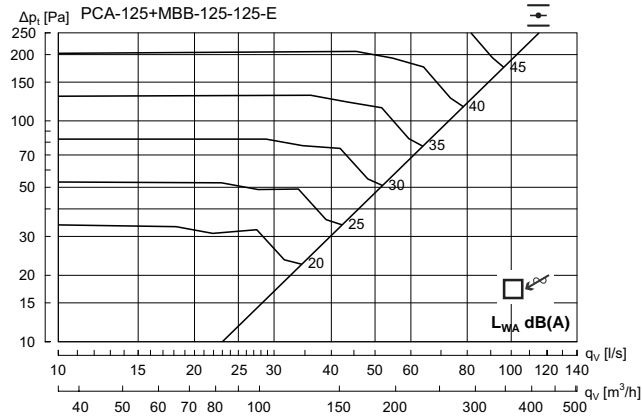

Hz	63	125	250	500	1K	2K	4K	8K
K_{ok}	13	5	-1	-4	-4	-11	-15	-20

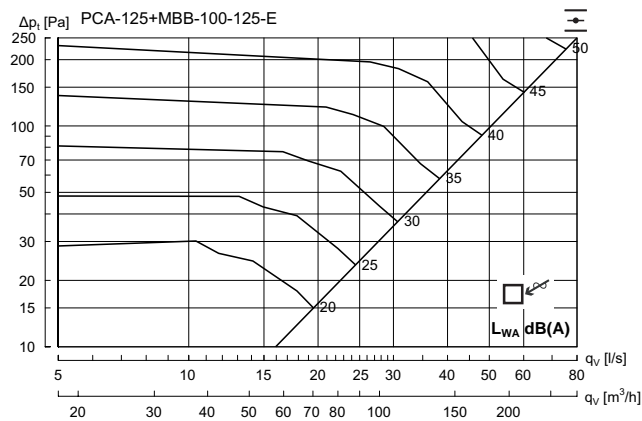

Hz	63	125	250	500	1K	2K	4K	8K
K_{ok}	13	-1	3	-3	-6	-10	-16	-19

PCA 160 + MBB - Exhaust air

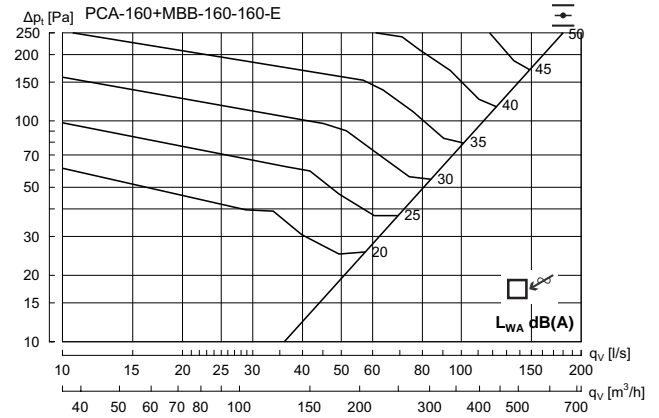

Hz	63	125	250	500	1K	2K	4K	8K
K_{ok}	16	6	-1	-5	-4	-10	-15	-19

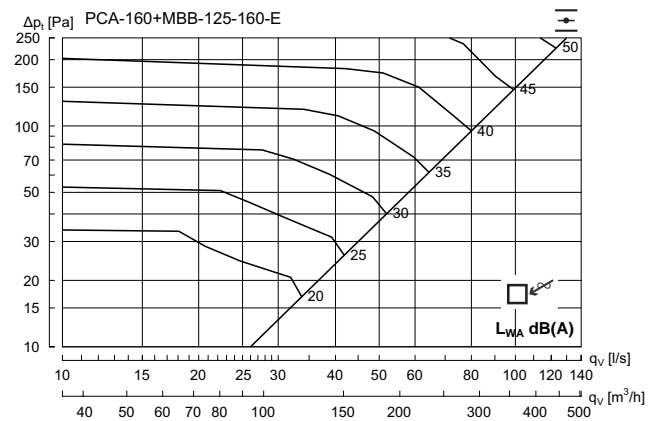

Hz	63	125	250	500	1K	2K	4K	8K
K_{ok}	13	5	0	-3	-5	-11	-15	-22

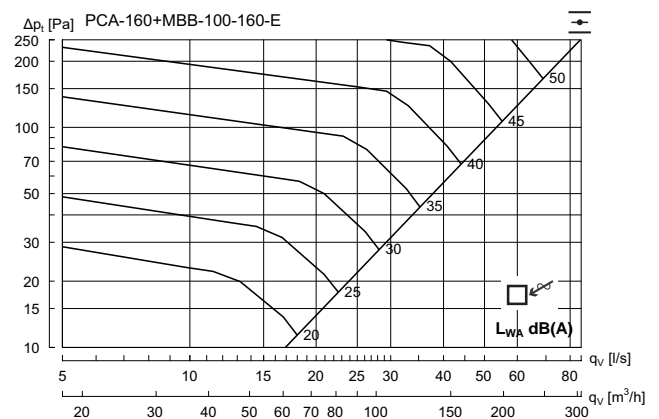

Hz	63	125	250	500	1K	2K	4K	8K
K_{ok}	10	-1	5	-3	-8	-11	-18	-25

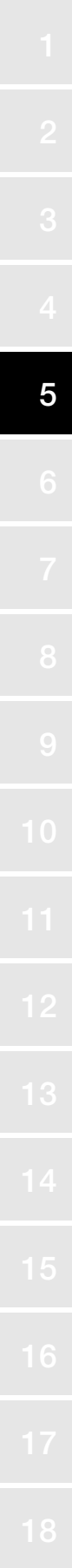

Perforated diffuser

PCA

Technical data

PCA 200 + MBB - Exhaust air

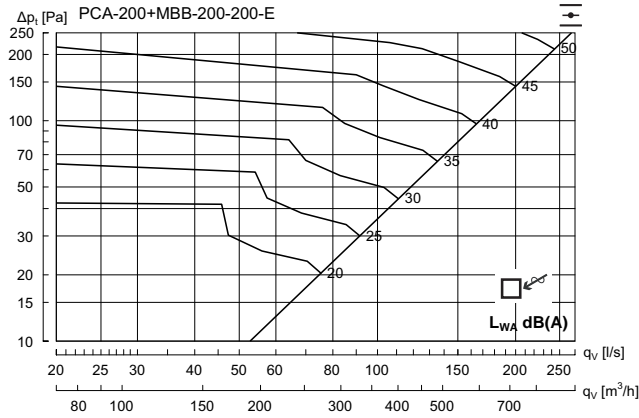

Hz	63	125	250	500	1K	2K	4K	8K
K_{sk}	15	4	-1	-4	-5	-9	-16	-25

PCA 250 + MBB - Exhaust air

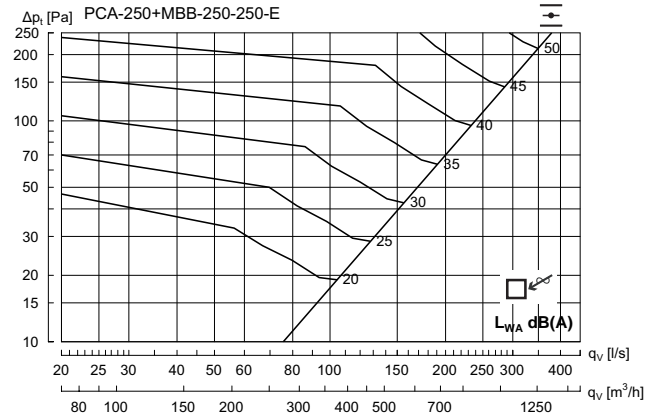

Hz	63	125	250	500	1K	2K	4K	8K
K_{sk}	10	5	2	-3	-5	-11	-16	-25

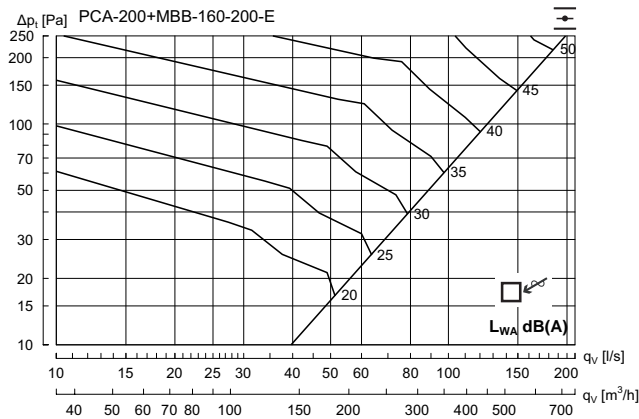

Hz	63	125	250	500	1K	2K	4K	8K
K_{sk}	15	6	-1	-5	-5	-9	-14	-20

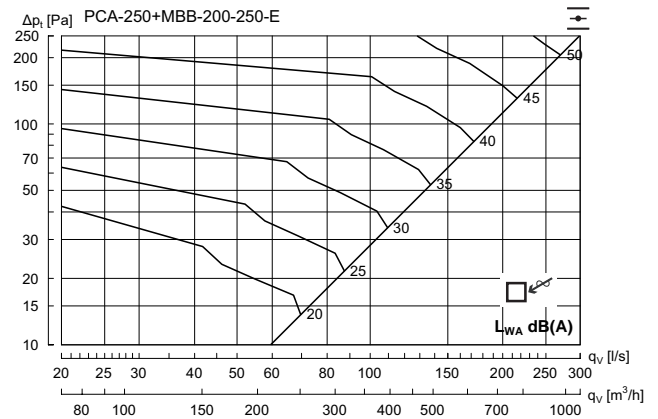

Hz	63	125	250	500	1K	2K	4K	8K
K_{sk}	12	5	0	-3	-5	-10	-14	-23

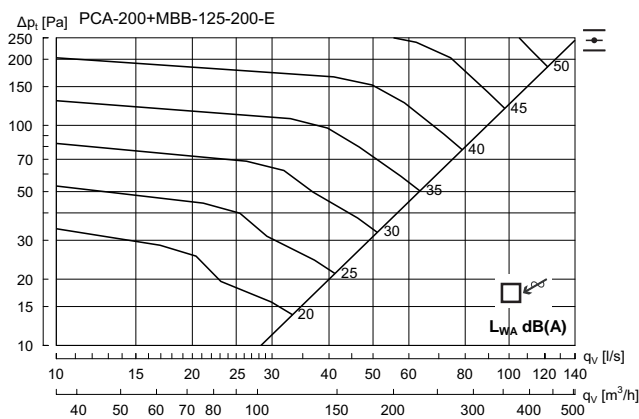

Hz	63	125	250	500	1K	2K	4K	8K
K_{sk}	9	3	1	-4	-5	-10	-14	-21

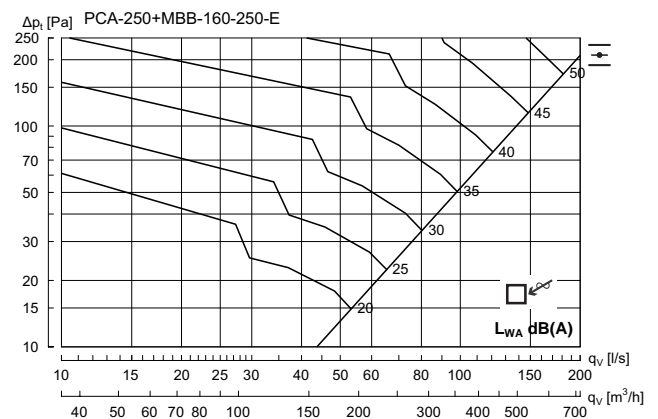

Hz	63	125	250	500	1K	2K	4K	8K
K_{sk}	16	6	0	-5	-5	-9	-15	-21

Perforated diffuser

PCA

Technical data

PCA 315 + MBB - Exhaust air

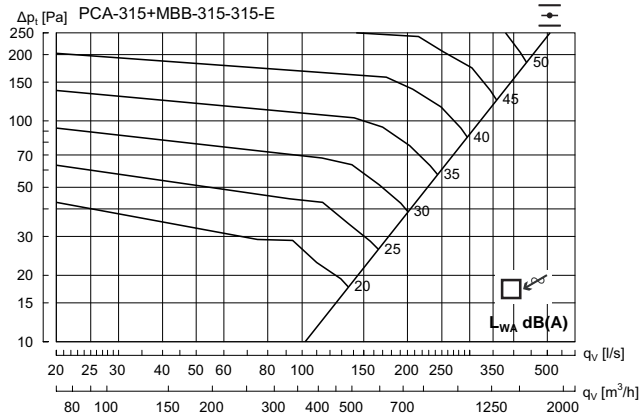

Hz	63	125	250	500	1K	2K	4K	8K
K_{sk}	13	5	3	-4	-6	-10	-16	-26

PCA 400 + MBB - Exhaust air

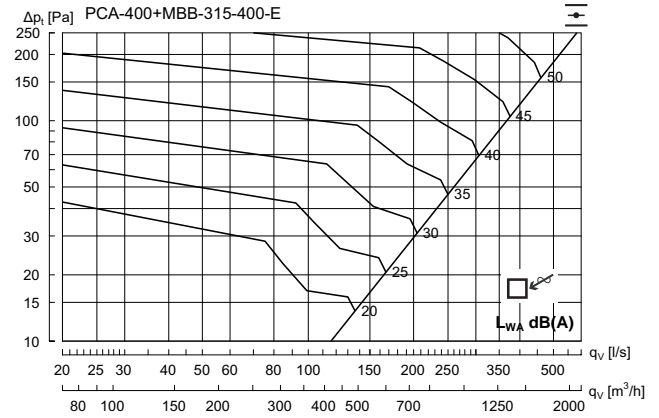

Hz	63	125	250	500	1K	2K	4K	8K
K_{sk}	10	4	2	-3	-6	-9	-14	-25

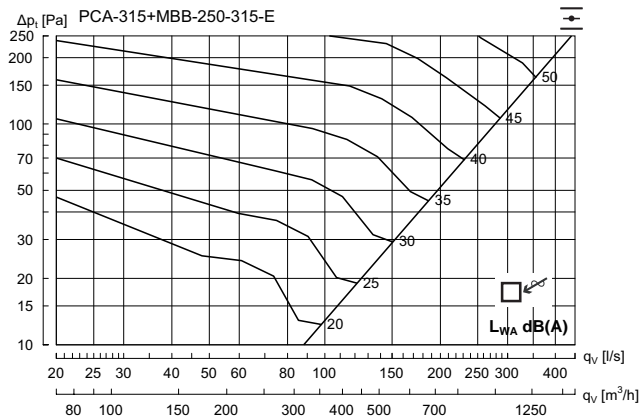

Hz	63	125	250	500	1K	2K	4K	8K
K_{sk}	7	5	2	-3	-6	-10	-16	-24

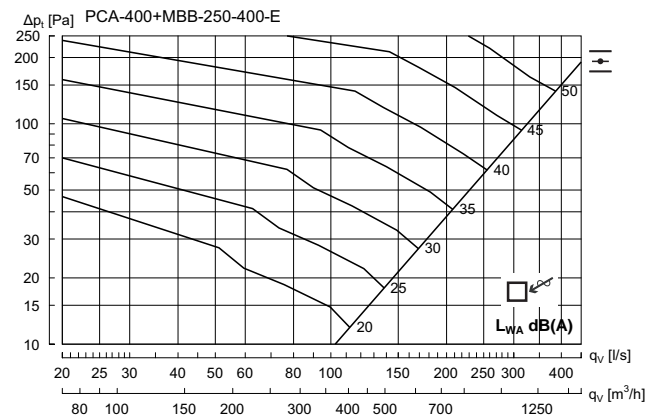

Hz	63	125	250	500	1K	2K	4K	8K
K_{sk}	10	5	2	-4	-5	-10	-15	-23

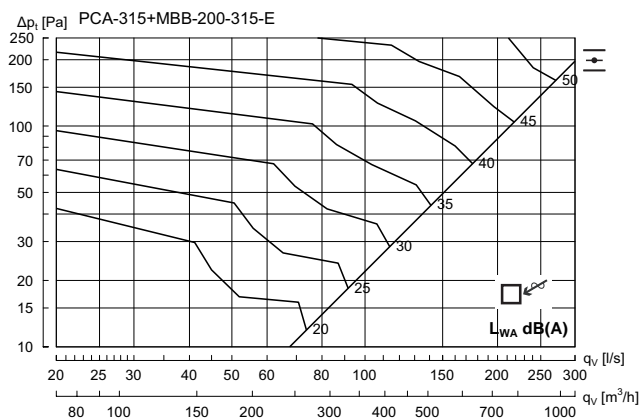

Hz	63	125	250	500	1K	2K	4K	8K
K_{sk}	13	5	0	-3	-5	-9	-15	-23

Plain diffuser

LKA



Description

LKA is a square diffuser with an unperforated face plate that can be used for both supply and exhaust air. LKA is suitable for the horizontal supply of cooled air where a high impulse is required. It can be equipped with accessories of various types. Installing an LKA diffuser in a plenum box type MBB can help to achieve a stable airflow to the diffuser as well as realise the potential for individual adjustment.

- Suitable for both supply and exhaust air
- Suitable for the horizontal supply of cooled air
- High impulse
- Option of 1, 2 and 3-way supply air

Maintenance

The face plate can be removed to enable cleaning of internal parts or to gain access to the duct or box. The visible parts of the diffuser can be wiped with a damp cloth.

Order code

Product Type LKA	LKA	aaa
Connection dim. Ød Ød 125-400		

Example: LKA-200

Dimensions

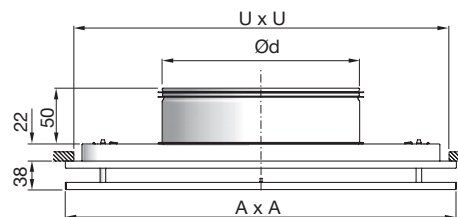

LKA Ød mm	A mm	U* mm	Free area A m ²	Weight kg
125	235	200	0,011	1,10
160	295	260	0,016	1,80
200	395	360	0,022	2,80
250	495	460	0,033	4,20
315	595	560	0,041	5,70
400	595	560	0,042	5,70

* U x U = Ceiling grid opening

Materials and finish:

Material:	Galvanised steel
Standard finish:	Powder-coated
Standard colour:	White RAL 9010, gloss 30

The diffuser is available in other colours. Please contact Lindab's sales department for further information.

Plain diffuser

LKA

Accessories

DRZ - Balancing damper

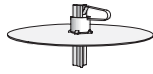
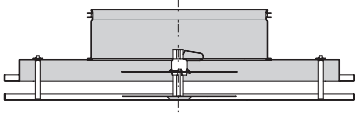

Blending profiles (set)

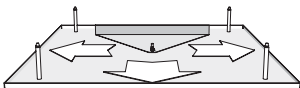
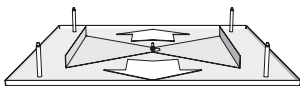
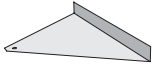
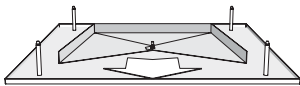

MBZ - Extension piece

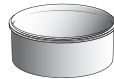

DKZ - Mounting brackets (set)

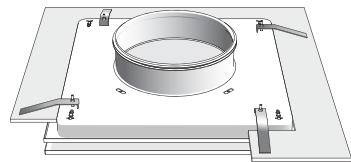
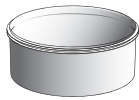

Order code - accessories

Product **aaa** **bbb**
 Type _____
 Size _____

Example: DRZ-200

LM - Module plate



Order code - module plate

Product **LM** **a** **LKA** **ccc**
 Type _____
 Ceiling system _____
 Diffuser _____
 Size _____

Example: LM-1-LKA-200

Ceiling system - see introductory summary.

MBB - Plenum box



LKA + MBB

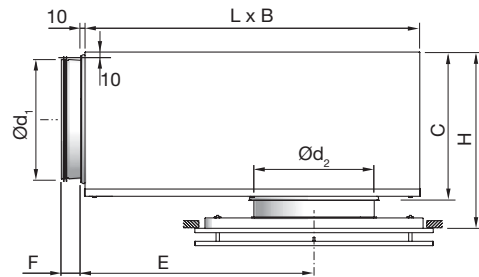

LKA + MBB		B	C	E	F	H*	L
duct	LKA	mm	mm	mm	mm	mm	mm
Ød ₁ mm	Ød ₂ mm						
100	125	260	159	216	50	180 - 220	310
100	160	260	159	216	50	180 - 220	310
125	125	310	184	262	50	205 - 245	376
125	160	310	184	262	50	205 - 245	376
125	200	310	184	262	50	205 - 245	376
160	160	380	220	323	50	239 - 279	459
160	200	380	220	323	50	239 - 279	459
160	250	380	220	323	50	239 - 279	459
200	200	460	259	396	70	280 - 320	565
200	250	460	259	396	70	280 - 320	565
200	315	460	259	396	70	280 - 320	565
250	250	540	309	486	70	330 - 370	698
250	315	540	309	486	70	330 - 370	698
250	400	540	309	486	70	330 - 370	698
315	315	540	373	646	70	395 - 435	858
315	400	540	373	646	70	395 - 435	858

* Using accessory MBZ the H dimension will increase:

Ød₂ = 125 - 200 mm => H +40 mm

Ød₂ = 250 - 315 mm => H +60 mm

Ød₂ = 400 mm => H +80 mm

Order code

Product **MBB** **aaa** **bbb** **c**
 Type _____
 MBB _____
 Duct connection **Ød₁** _____
 Ø100-315 _____
 Diffuser dimension **Ød₂** _____
 Ø125-400 _____
 Function _____
 S = Supply air
 E = Exhaust

Example: LKA-200+MBB-160-200-S

Plain diffuser

LKA

Technical data

Capacity

Air flow q_v [l/s] and [m³/h], total pressure Δp_t [Pa], throw $l_{0,2}$ [m] and sound power level L_{WA} [dB(A)] can be seen in the diagrams.

Frequency-related sound effect level

The sound effect level in the frequency band is defined as $L_{WA} + K_{OK}$. K_{OK} values are specified in chart beneath the diagrams on the following pages.

Quick selection, supply air

LKA + MBB		$\Delta p_t \geq 50$ Pa		$\Delta p_t \geq 50$ Pa	
duct	LKA	30 dB(A)		35 dB(A)	
$\text{Ø}d_1$	$\text{Ø}d_2$	l/s	m ³ /h	l/s	m ³ /h
100	125	31	112	38	137
100	160	40	144	49	176
125	125	42	151	50	180
125	160	53	191	64	230
125	200	63	227	75	270
160	160	60	216	73	263
160	200	70	252	88	317
160	250	94	338	115	414
200	200	98	353	118	425
200	250	106	382	129	464
200	315	133	479	159	572
250	250	116	418	141	508
250	315	136	490	167	601
250	400	139	500	182	655
315	315	153	551	183	659
315	400	169	608	200	720

Sound attenuation

Sound attenuation of the diffuser ΔL from duct to room, including end reflection, see table below

LKA + MBB		Centre frequency Hz							
duct	LKA	63	125	250	500	1K	2K	4K	8K
$\text{Ø}d_1$	$\text{Ø}d_2$								
100	125	20	17	6	16	19	20	18	22
100	160	21	17	5	12	19	20	18	21
125	125	17	14	9	19	15	21	18	20
125	160	13	13	9	18	18	18	18	20
125	200	14	12	7	15	16	18	17	19
160	160	18	17	11	16	21	19	20	21
160	200	15	14	9	20	21	20	20	20
160	250	16	16	7	17	13	18	19	20
200	200	14	11	8	15	21	18	20	18
200	250	13	10	8	16	20	17	19	17
200	315	15	9	6	14	17	17	18	17
250	250	16	9	9	17	20	19	19	19
250	315	15	8	9	16	18	16	18	18
250	400	13	6	6	14	16	17	17	17
315	315	8	10	10	16	20	19	18	23
315	400	8	10	10	13	19	19	17	21

Balancing

Balancing data is contained in a separate brochure.

Throw $l_{0,2}$

The throw is specified at a terminal velocity of 0.2 m/s.

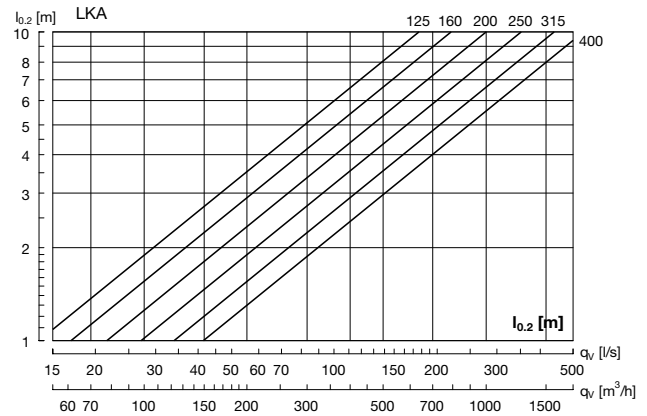

Correction throw $L_{0,2}$

LKA Ød	1 - ways	2 - ways	3 - ways
125	2.3	1.8	1.3
160	2.3	1.8	1.3
200	2.3	1.9	1.3
250	2.3	2	1.3
315	2.3	2	1.3
400	2.2	2.1	1.3

Air jet distribution

l_b = Distance from the diffuser to the point where there is maximum dispersal.

b_v = Depth of the air jet on a vertical plane.

b_h = Width of the air jet on a horizontal plane.

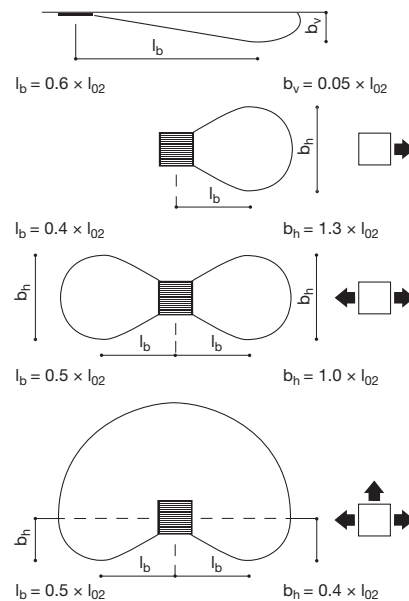

Plain diffuser

LKA

Technical data

LKA without box - Supply air

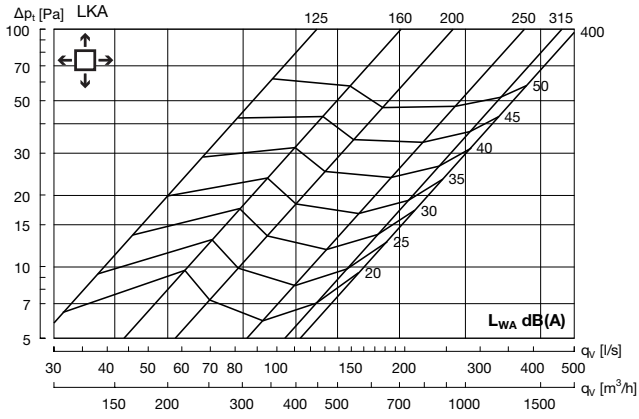

LKA 125 + MBB - Supply air

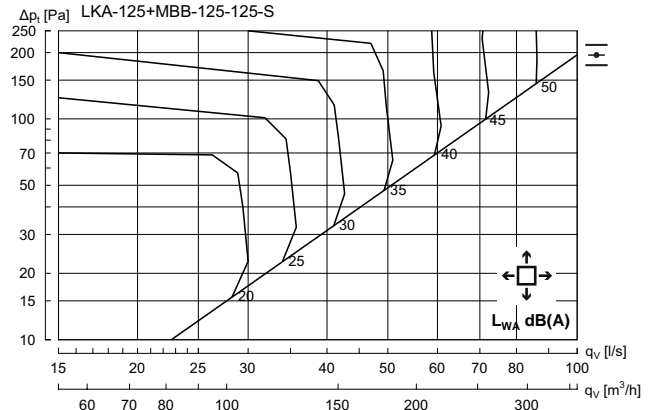

Hz	63	125	250	500	1K	2K	4K	8K
K_{uk}	12	6	1	-4	-4	-13	-20	-28

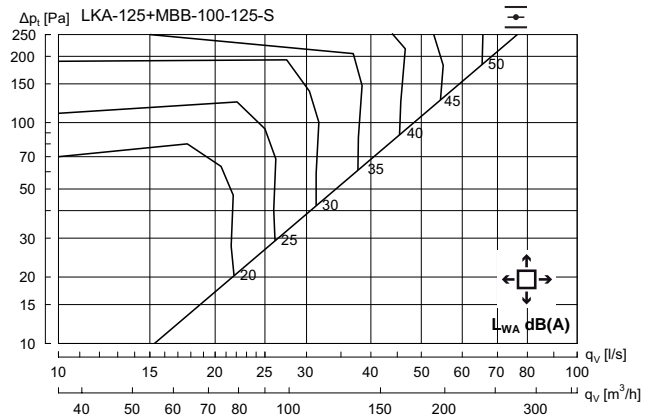

Hz	63	125	250	500	1K	2K	4K	8K
K_{uk}	11	7	3	-4	-5	-14	-18	-24

Plain diffuser

LKA

Technical data

LKA 160 + MBB - Supply air

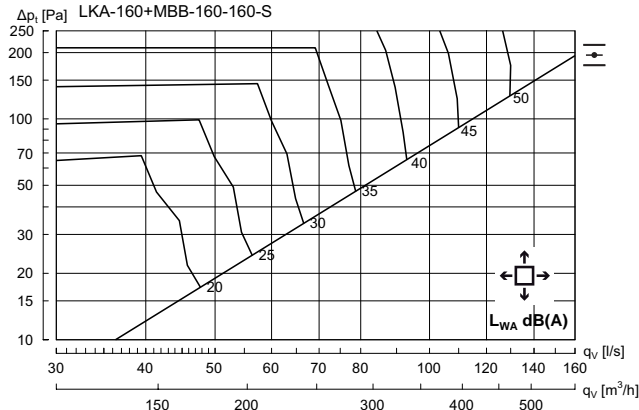

Hz	63	125	250	500	1K	2K	4K	8K
K_{ok}	11	11	0	-2	-7	-15	-22	-28

LKA 200 + MBB - Supply air

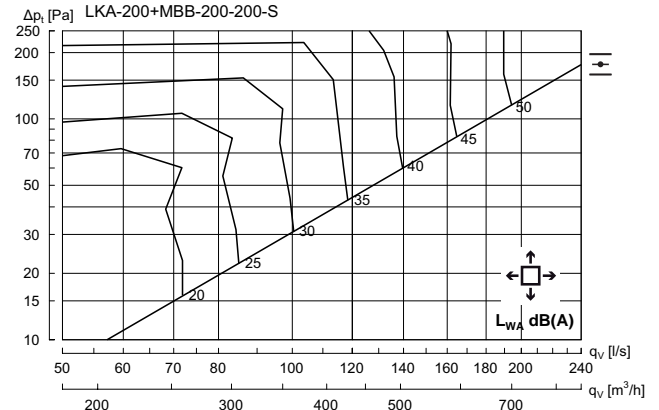

Hz	63	125	250	500	1K	2K	4K	8K
K_{ok}	12	6	-1	-1	-5	-15	-21	-26

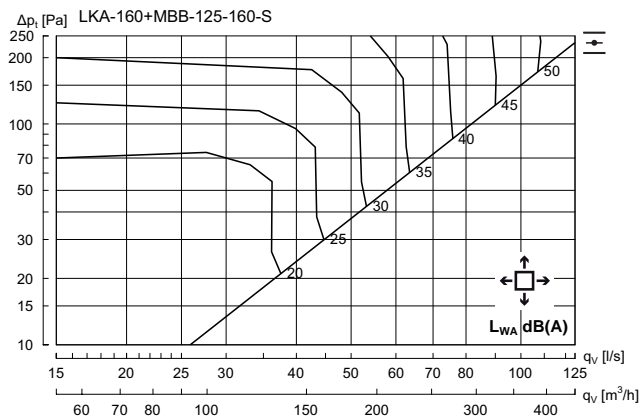

Hz	63	125	250	500	1K	2K	4K	8K
K_{ok}	13	8	1	-3	-6	-12	-17	-25

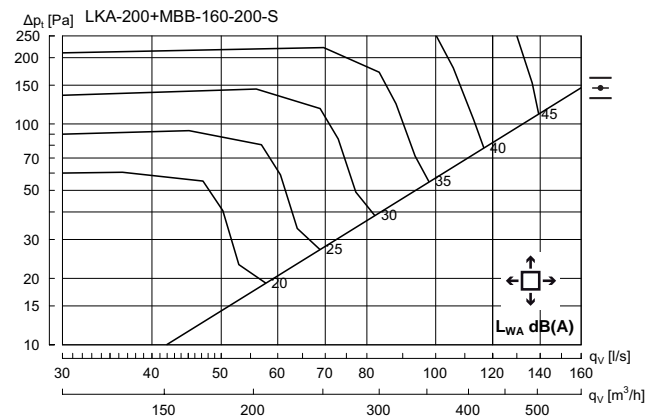

Hz	63	125	250	500	1K	2K	4K	8K
K_{ok}	12	9	0	-2	-6	-12	-19	-24

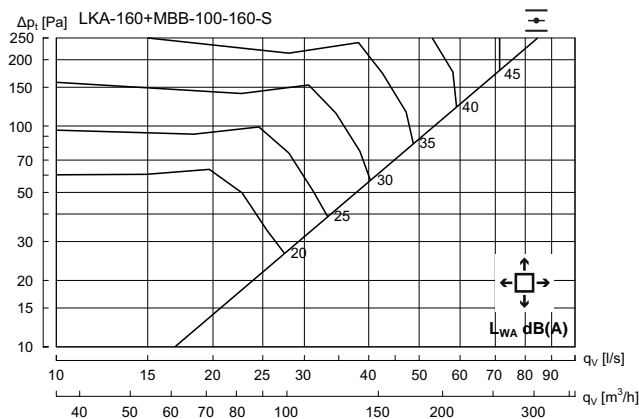

Hz	63	125	250	500	1K	2K	4K	8K
K_{ok}	12	5	1	-2	-6	-10	-14	-20

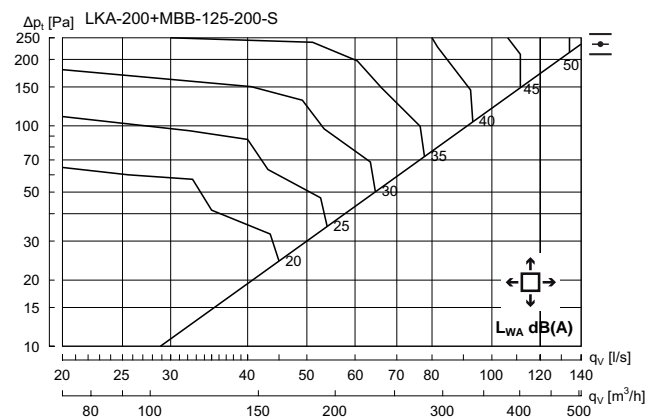

Hz	63	125	250	500	1K	2K	4K	8K
K_{ok}	12	7	1	-3	-6	-11	-15	-21

Plain diffuser

LKA

Technical data

LKA 250 + MBB - Supply air

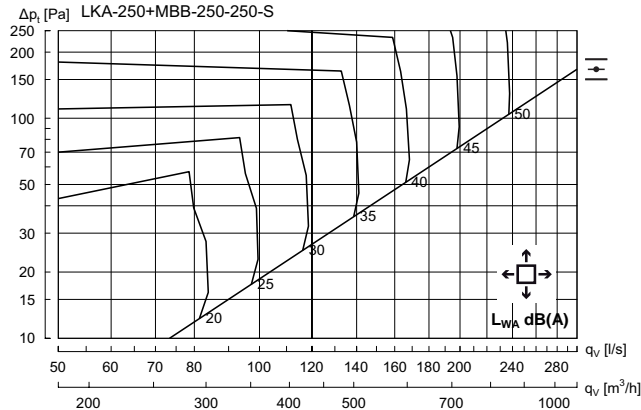

Hz	63	125	250	500	1K	2K	4K	8K
K_{ok}	12	3	-4	0	-4	-17	-24	-31

LKA 315 + MBB - Supply air

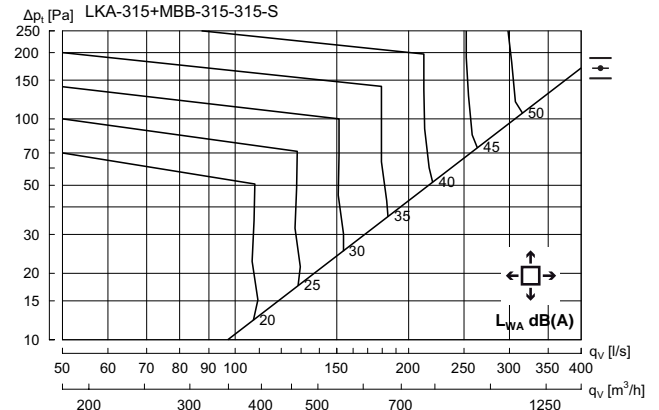

Hz	63	125	250	500	1K	2K	4K	8K
K_{ok}	13	5	-2	-1	-4	-17	-25	-36

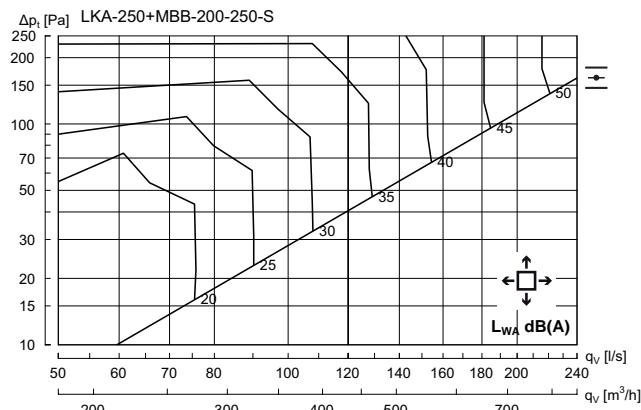

Hz	63	125	250	500	1K	2K	4K	8K
K_{ok}	12	6	-2	-1	-5	-14	-19	-23

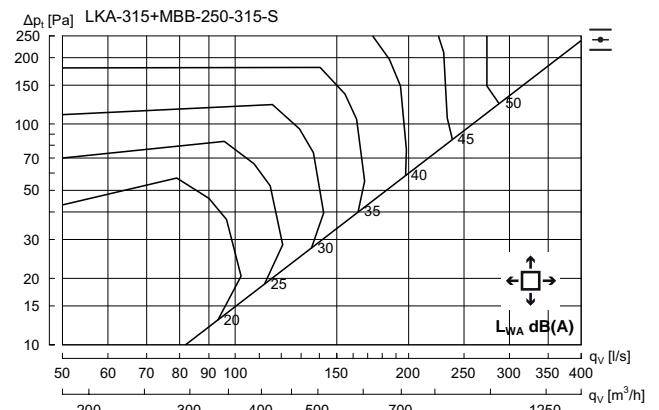

Hz	63	125	250	500	1K	2K	4K	8K
K_{ok}	14	5	-2	-2	-4	-13	-19	-26

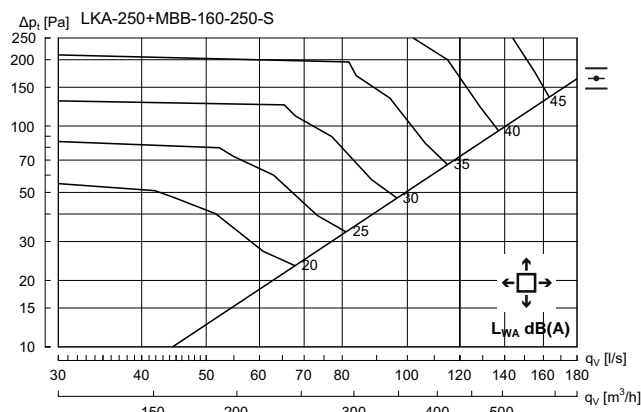

Hz	63	125	250	500	1K	2K	4K	8K
K_{ok}	9	7	-2	-3	-5	-10	-15	-21

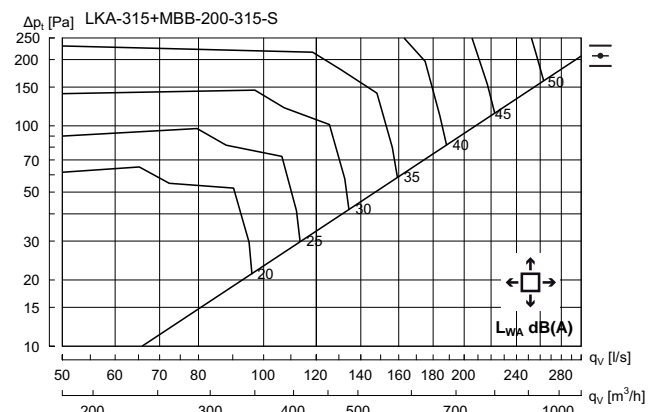

Hz	63	125	250	500	1K	2K	4K	8K
K_{ok}	13	6	-2	-3	-4	-11	-17	-22

Plain diffuser

LKA

Technical data

LKA 400 + MBB - Supply air

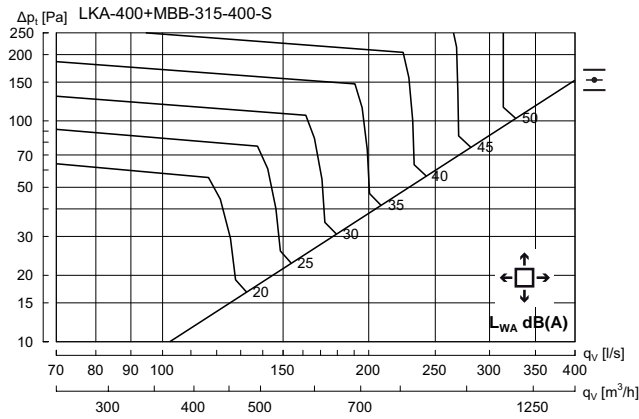

Hz	63	125	250	500	1K	2K	4K	8K
K_{uk}	14	6	1	-1	-6	-16	-21	-27

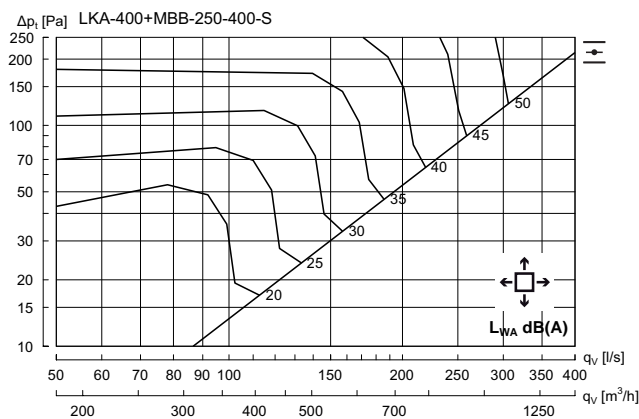

Hz	63	125	250	500	1K	2K	4K	8K
K_{uk}	12	7	0	-2	-6	-12	-19	-26

LKA + MBB - Supply air

Correction sound power level (L_{WA}) and pressure loss (Δp_t)

LKA + MBB		1 - ways		2 - ways		3 - ways	
duct	PKA	L_{WA}	Δp_t	L_{WA}	Δp_t	L_{WA}	Δp_t
$\text{Ø}d_1$	$\text{Ø}d_2$						
100	125	+ 10	x 1,3	+ 4	x 1,1	+ 2	x 1,05
100	160	+ 5	x 1,1	+ 2	x 1,05	+ 1	x 1
125	125	+ 10	x 1,35	+ 6	x 1,1	+ 4	x 1,05
125	160	+ 10	x 1,4	+ 4	x 1,1	+ 1	x 1
125	200	+ 4	x 1,2	+ 2	x 1,05	+ 1	x 1
160	160	+ 16	x 1,8	+ 9	x 1,3	+ 4	x 1,1
160	200	+ 16	x 1,7	+ 10	x 1,2	+ 4	x 1,05
160	250	+ 10	x 1,3	+ 6	x 1,1	+ 3	x 1
200	200	+ 17	x 2,3	+ 11	x 1,4	+ 7	x 1,1
200	250	+ 13	x 1,8	+ 6	x 1,2	+ 4	x 1,1
200	315	+ 9	x 1,5	+ 4	x 1,1	+ 0	x 1,05
250	250	+ 21	x 2,1	+ 11	x 1,4	+ 7	x 1,2
250	315	+ 19	x 1,8	+ 7	x 1,2	+ 3	x 1,1
250	400	+ 10	x 1,5	+ 6	x 1,2	+ 0	x 1
315	315	+ 21	x 2,1	+ 10	x 1,3	+ 4	x 1,1
315	400	+ 21	x 1,8	+ 8	x 1,5	+ 3	x 1,2



Plain diffuser

LKA

Technical data

LKA without box - Exhaust air

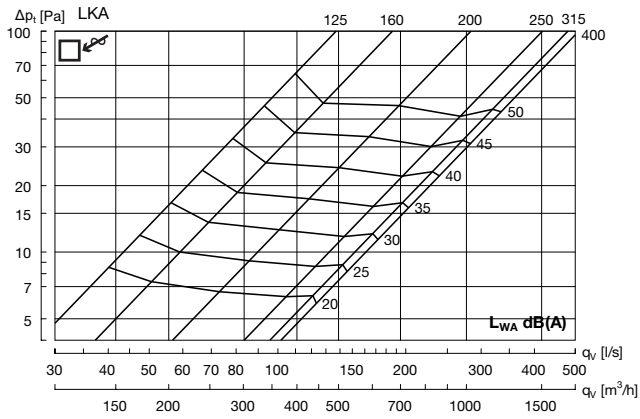

LKA 125 + MBB - Exhaust air

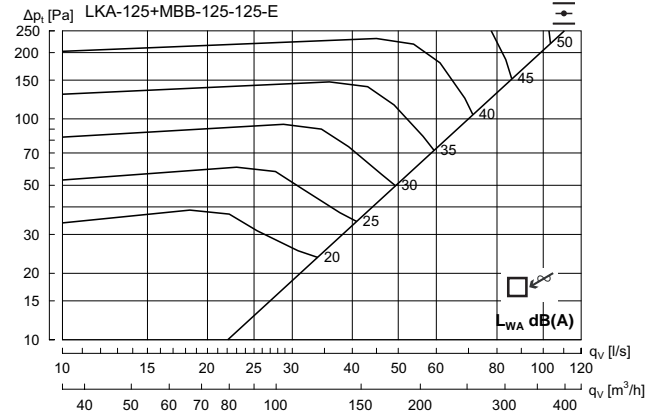

Hz	63	125	250	500	1K	2K	4K	8K
K_{uk}	13	4	1	-2	-5	-12	-15	-22

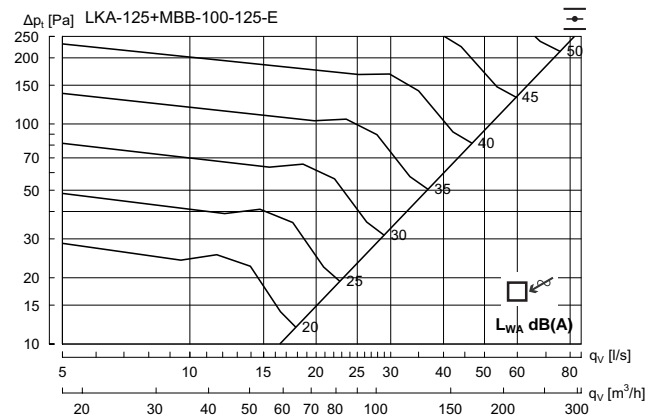

Hz	63	125	250	500	1K	2K	4K	8K
K_{uk}	13	0	4	-2	-8	-11	-16	-22

Plain diffuser

LKA

Technical data

LKA 160 + MBB - Exhaust air

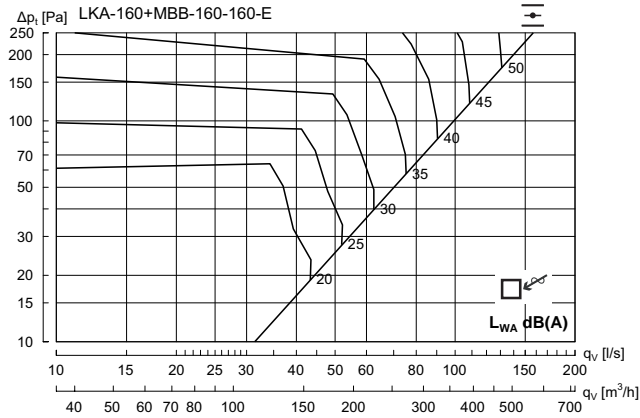

Hz	63	125	250	500	1K	2K	4K	8K
K_{ok}	16	6	1	-4	-5	-11	-17	-24

LKA 200 + MBB - Exhaust air

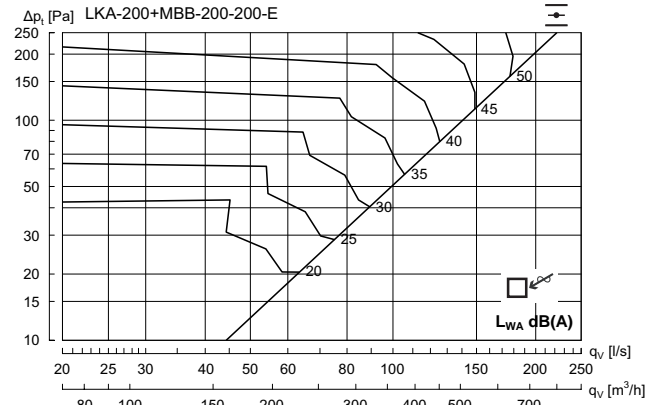

Hz	63	125	250	500	1K	2K	4K	8K
K_{ok}	14	6	0	-3	-5	-10	-19	-27

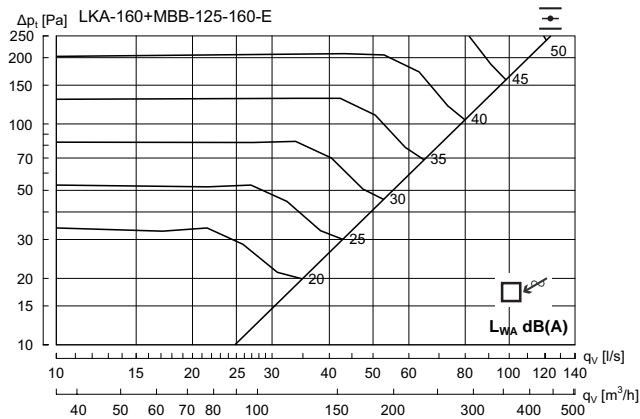

Hz	63	125	250	500	1K	2K	4K	8K
K_{ok}	12	6	2	-2	-7	-12	-14	-19

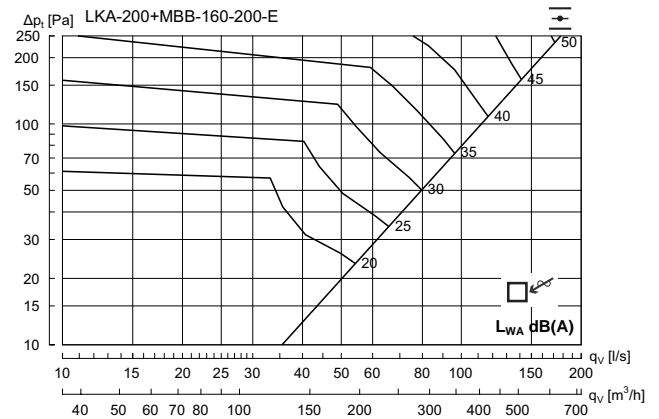

Hz	63	125	250	500	1K	2K	4K	8K
K_{ok}	16	7	-1	-4	-6	-10	-14	-20

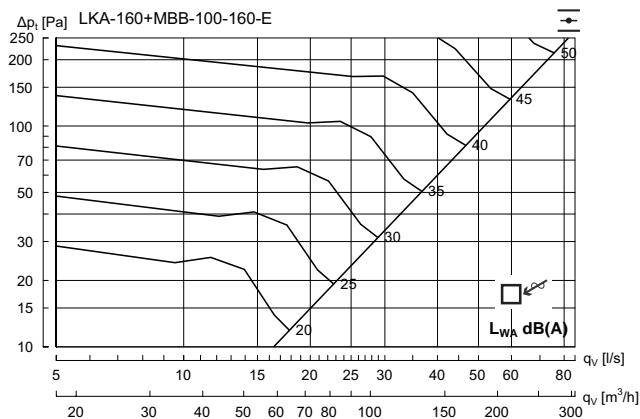

Hz	63	125	250	500	1K	2K	4K	8K
K_{ok}	11	-1	5	-2	-9	-13	-18	-24

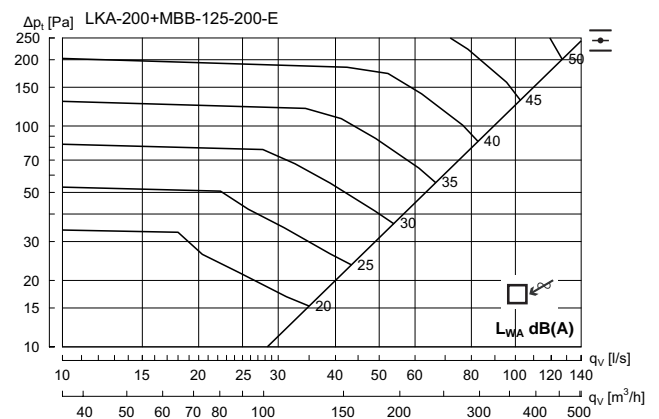

Hz	63	125	250	500	1K	2K	4K	8K
K_{ok}	11	3	0	-2	-5	-11	-14	-21



Plain diffuser

LKA

Technical data

LKA 250 + MBB - Exhaust air

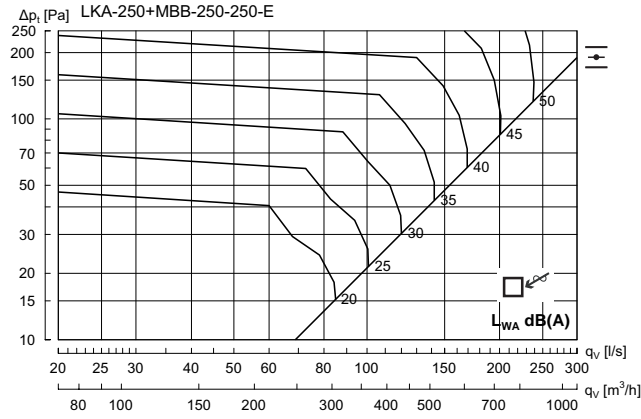

Hz	63	125	250	500	1K	2K	4K	8K
K_{ok}	12	4	-1	-3	-3	-12	-19	-30

LKA 315 + MBB - Exhaust air

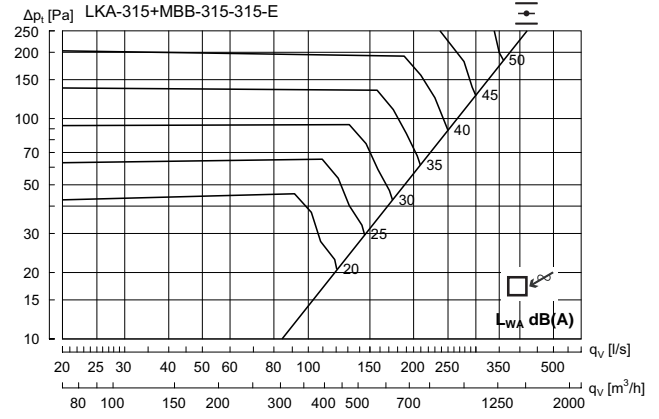

Hz	63	125	250	500	1K	2K	4K	8K
K_{ok}	13	5	2	-2	-6	-12	-17	-27

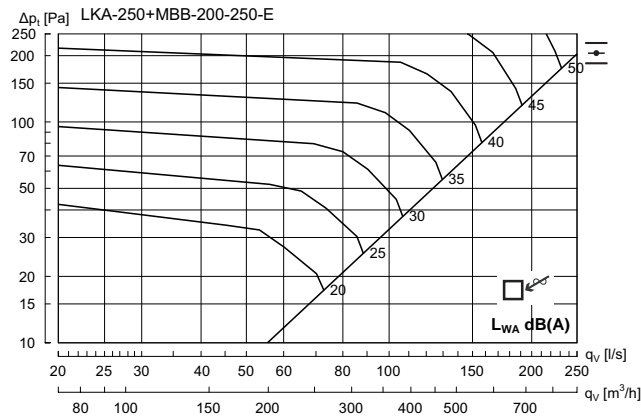

Hz	63	125	250	500	1K	2K	4K	8K
K_{ok}	13	3	-1	-3	-4	-11	-15	-24

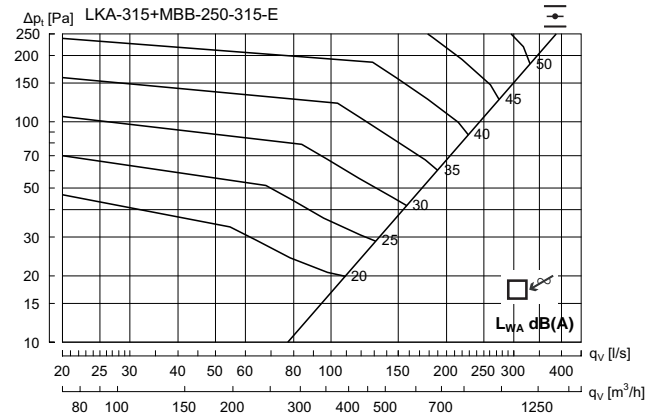

Hz	63	125	250	500	1K	2K	4K	8K
K_{ok}	10	5	1	-2	-6	-10	-16	-24

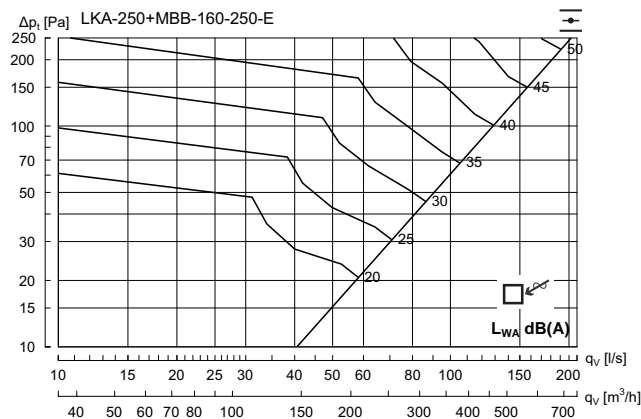

Hz	63	125	250	500	1K	2K	4K	8K
K_{ok}	14	6	0	-3	-5	-11	-15	-19

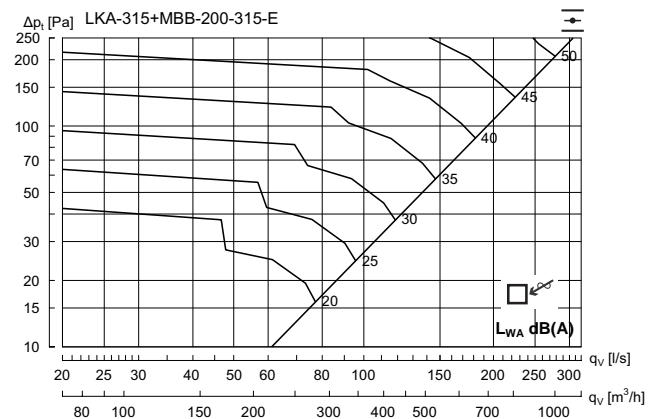

Hz	63	125	250	500	1K	2K	4K	8K
K_{ok}	14	5	0	-2	-6	-12	-14	-22

Plain diffuser

LKA

Technical data

LKA 400 + MBB - Exhaust air

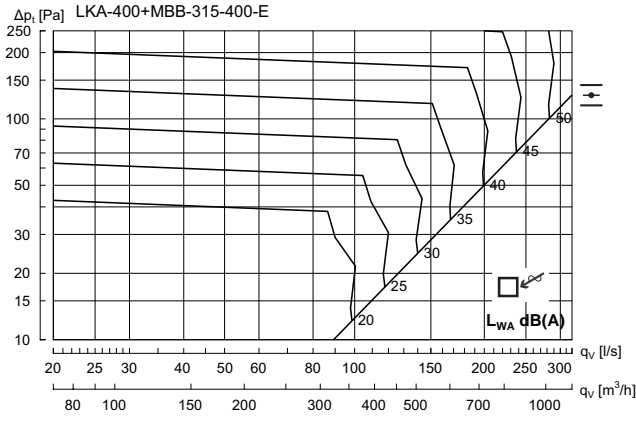

Hz	63	125	250	500	1K	2K	4K	8K
K_{α}	10	5	0	0	-6	-15	-20	-27

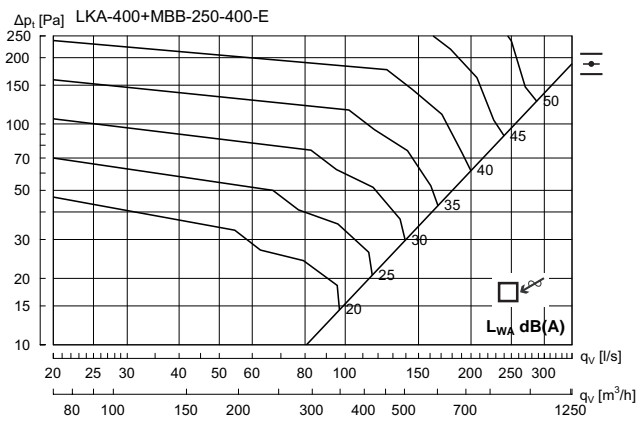

Hz	63	125	250	500	1K	2K	4K	8K
K_{α}	12	5	1	-1	-7	-12	-16	-24

- 1
- 2
- 3
- 4
- 5
- 6
- 7
- 8
- 9
- 10
- 11
- 12
- 13
- 14
- 15
- 16
- 17
- 18

Plain diffuser

LCA



Description

LCA is a circular diffuser with an unperforated face plate that can be used for both supply and exhaust air. LCA is suitable for the horizontal supply of cooled air where a high impulse is required. It can be equipped with accessories of various types in order to achieve optimum function. Installing an LCA diffuser in a plenum box type MBB can help to achieve a stable airflow to the diffuser as well as realise the potential for individual adjustment.

- Suitable for both supply and exhaust air
- Suitable for the horizontal supply of cooled air
- High impulse
- Option of 1, 2 and 3-way supply air
- Discrete design

Maintenance

The face plate can be removed to enable cleaning of internal parts or to gain access to the duct or box. The visible parts of the diffuser can be wiped with a damp cloth.

Order code

Product	LCA	aaa
Type	LCA	
Connection dim. Ød	Ød 100-400	

Example: LCA-200

Dimensions

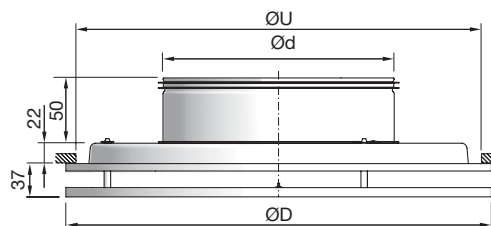

LCA Ød mm	ØD mm	ØU* mm	Free area A m ²	Weight kg
100	240	200	0,010	1,00
125	240	200	0,011	1,00
160	300	260	0,0165	1,50
200	360	320	0,023	2,30
250	460	420	0,03	3,40
315	540	500	0,037	4,60
400	540	500	0,037	4,60

* ØU = Ceiling grid opening

Materials and finish

Material: Galvanised steel
 Standard finish: Powder-coated
 Standard colour: White RAL 9010, gloss 30

The diffuser is available in other colours. Please contact Lindab's sales department for further information.

Plain diffuser

LCA

Accessories

DRZ - Balancing damper

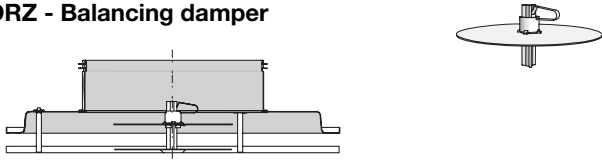

Blending profiles (set)

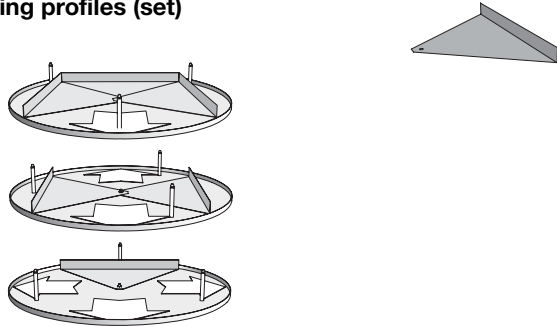

MBZ - Extension piece



DDZ - Mounting brackets (set)

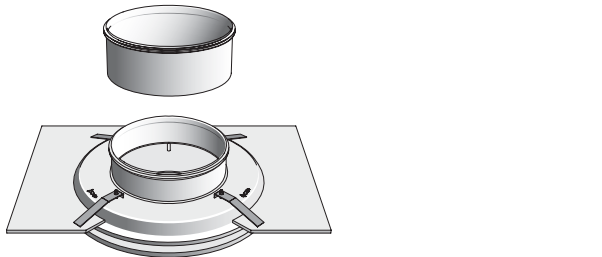

Order code - accessories

Product	aaa	bbb
Type		
Size		

Example: DRZ-200

LM - Module plate

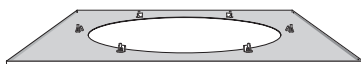

Order code - module plate

Product	LM	a	LCA	ccc
Type				
Ceiling system				
Diffuser				
Size				

Example: LM-1-LCA-200

Ceiling system - see introductory summary

MBB - Plenum box



LCA + MBB

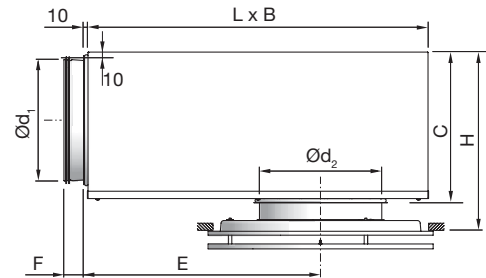

LCA + MBB		B	C	E	F	H*	L
duct	LCA	mm	mm	mm	mm	mm	mm
Ød ₁ mm	Ød ₂ mm						
100	100	260	159	216	50	180 - 220	310
100	125	260	159	216	50	180 - 220	310
100	160	260	159	216	50	180 - 220	310
125	125	310	184	262	50	205 - 245	376
125	160	310	184	262	50	205 - 245	376
125	200	310	184	262	50	205 - 245	376
160	160	380	220	323	50	239 - 279	459
160	200	380	220	323	50	239 - 279	459
160	250	380	220	323	50	239 - 279	459
200	200	460	259	396	70	280 - 320	565
200	250	460	259	396	70	280 - 320	565
200	315	460	259	396	70	280 - 320	565
250	250	540	309	486	70	330 - 370	698
250	315	540	309	486	70	330 - 370	698
250	400	540	309	486	70	330 - 370	698
315	315	540	373	646	70	395 - 435	858
315	400	540	373	646	70	395 - 435	858

* Using accessory MBZ the H dimension will increase:

$$\text{Ød}_2 = 100 - 200 \text{ mm} \Rightarrow H + 40 \text{ mm}$$

$$\text{Ød}_2 = 250 - 315 \text{ mm} \Rightarrow H + 60 \text{ mm}$$

$$\text{Ød}_2 = 400 \text{ mm} \Rightarrow H + 80 \text{ mm}$$

Order code

Product	MBB	aaa	bbb	c
Type				
MBB				
Duct connection Ød ₁				
Ø100-315				
Diffuser dimension Ød ₂				
Ø100-400				
Function				
S = Supply air				
E = Exhaust				

Example: LCA-200+MBB-200-200-S

Plain diffuser

LCA

Technical data

Capacity

Air flow q_v [l/s] and [m³/h], total pressure Δp_t [Pa], throw $l_{0,2}$ [m] and sound power level L_{WA} [dB(A)] can be seen in the diagrams.

Frequency-related sound effect level

The sound effect level in the frequency band is defined as $L_{WA}+K_{Ok}$. K_{Ok} values are specified in charts beneath the diagrams on the following pages.

Quick selection, supply air

LCA + MBB		$\Delta p_t \geq 50$ Pa 30 dB(A)		$\Delta p_t \geq 50$ Pa 35 dB(A)	
duct $\varnothing d_1$	LCA $\varnothing d_2$	l/s	m ³ /h	l/s	m ³ /h
100	100	27	97	33	119
100	125	31	112	38	137
100	160	40	144	49	176
125	125	42	151	50	180
125	160	53	191	64	230
125	200	59	212	70	252
160	160	60	216	73	263
160	200	70	252	88	317
160	250	94	338	115	414
200	200	98	353	118	425
200	250	106	382	129	464
200	315	133	479	159	572
250	250	116	418	141	508
250	315	136	490	167	601
250	400	139	500	182	655
315	315	153	551	183	659
315	400	169	608	200	720

Sound attenuation

Sound attenuation of the diffuser ΔL from duct to room, including end reflection, see table below.

LCA + MBB		Centre frequency Hz							
duct $\varnothing d_1$	LCA $\varnothing d_2$	63	125	250	500	1K	2K	4K	8K
100	100	18	17	9	19	20	23	22	23
100	125	20	17	6	16	19	20	18	22
100	160	21	17	5	12	19	20	18	21
125	125	17	14	9	19	15	21	18	20
125	160	13	13	9	18	18	18	18	20
125	200	14	12	7	15	16	18	17	19
160	160	18	17	11	16	21	19	20	21
160	200	15	14	9	20	21	20	20	20
160	250	16	16	7	17	13	18	19	20
200	200	14	11	8	15	21	18	20	18
200	250	13	10	8	16	20	17	19	17
200	315	15	9	6	14	17	17	18	17
250	250	16	9	9	17	20	19	19	19
250	315	15	8	9	16	18	16	18	18
250	400	13	6	6	14	16	17	17	17
315	315	8	10	10	16	20	19	18	23
315	400	8	10	10	13	19	19	17	21

Balancing

Balancing data is contained in a separate brochure.

Throw $l_{0,2}$

The throw is specified at a terminal velocity of 0.2 m/s .

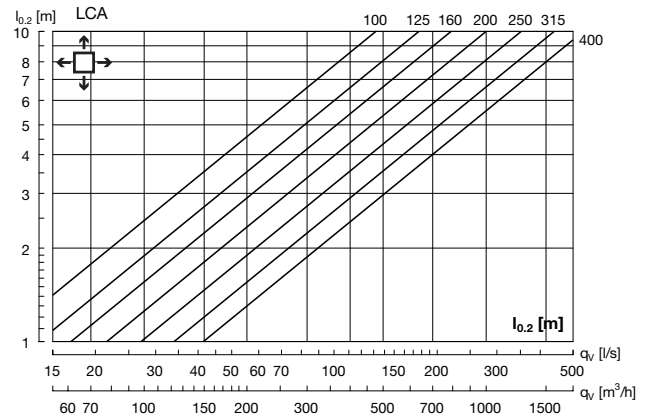

Correction throw $l_{0,2}$

LCA $\varnothing d$	1 - ways	2 - ways	3 - ways
100	2.4	1.8	1.4
125	2.3	1.8	1.3
160	2.3	1.8	1.3
200	2.3	1.9	1.3
250	2.3	2	1.3
315	2.3	2	1.3
400	2.2	2.1	1.3

Air jet distribution

l_b = Distance from the diffuser to the point where there is maximum dispersal.

b_v = Depth of the air jet on a vertical plane.

b_h = Width of the air jet on a horizontal plane.

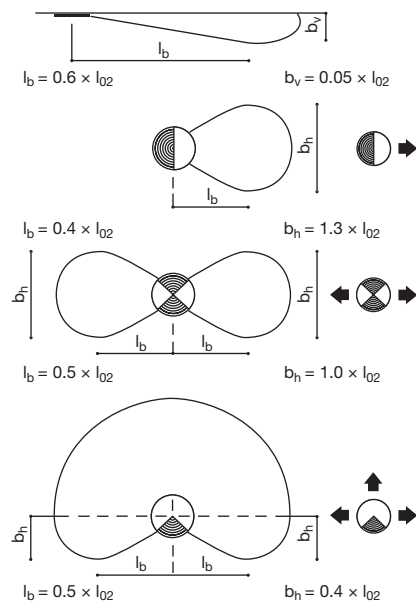

Plain diffuser

LCA

Technical data

LCA without box - Supply air

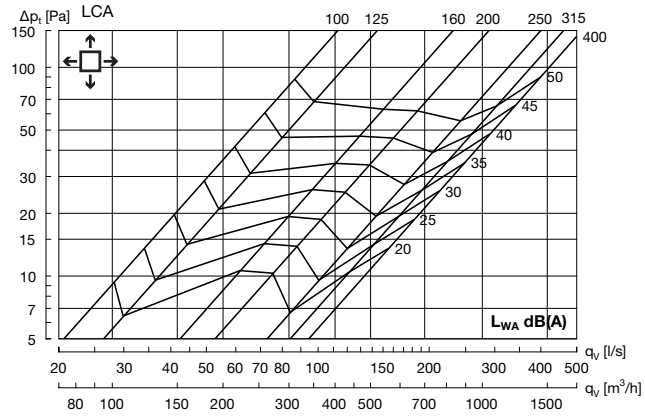

LCA 100 + MBB - Supply air

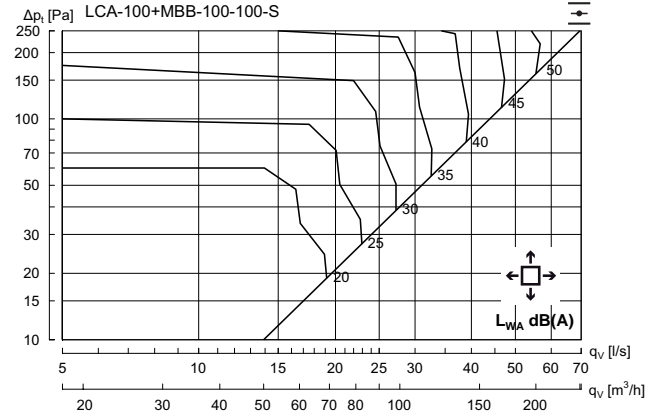

Hz	63	125	250	500	1K	2K	4K	8K
K_{ok}	9	7	3	-5	-5	-12	-16	-23

Plain diffuser

LCA

Technical data

LCA 125 + MBB - Supply air

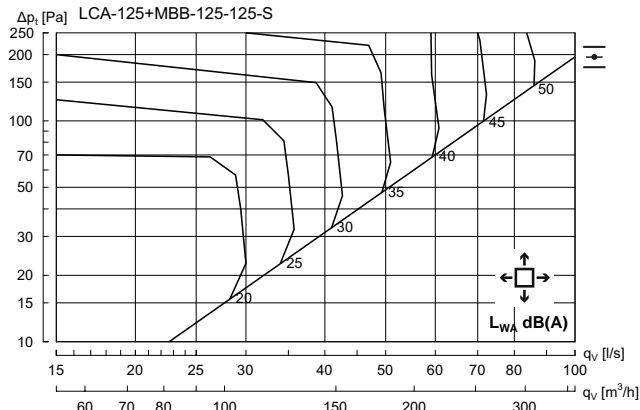

Hz	63	125	250	500	1K	2K	4K	8K
K_{ok}	12	6	1	-4	-4	-13	-20	-28

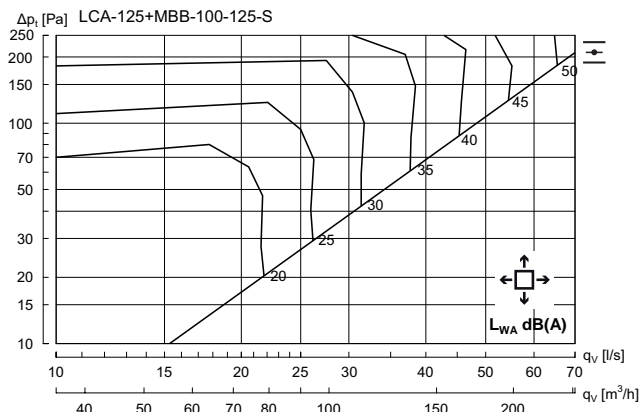

Hz	63	125	250	500	1K	2K	4K	8K
K_{ok}	11	7	3	-4	-5	-14	-18	-24

LCA 160 + MBB - Supply air

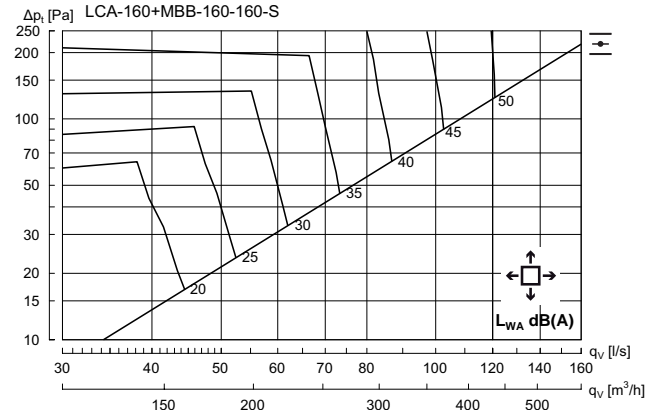

Hz	63	125	250	500	1K	2K	4K	8K
K_{ok}	11	11	0	-2	-7	-15	-22	-28

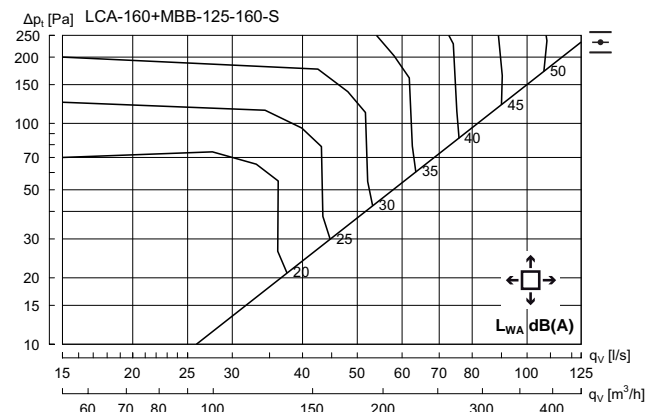

Hz	63	125	250	500	1K	2K	4K	8K
K_{ok}	13	8	1	-3	-6	-12	-17	-25

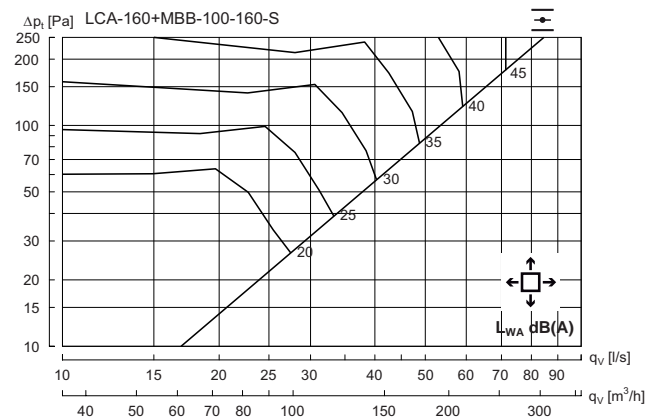

Hz	63	125	250	500	1K	2K	4K	8K
K_{ok}	12	5	1	-2	-6	-10	-14	-20

Plain diffuser

LCA

Technical data

LCA 200 + MBB - Supply air

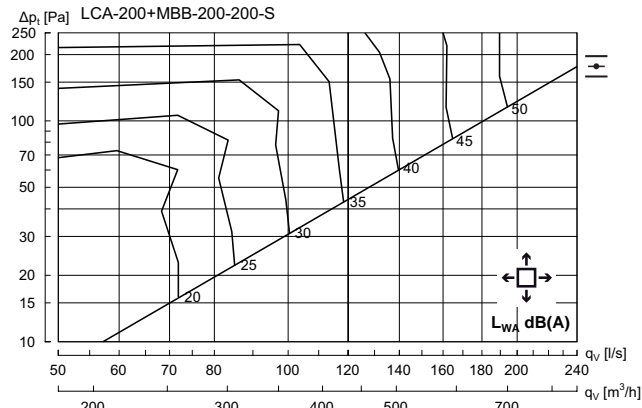

Hz	63	125	250	500	1K	2K	4K	8K
K_{ok}	12	6	-1	-1	-5	-15	-21	-26

LCA 250 + MBB - Supply air

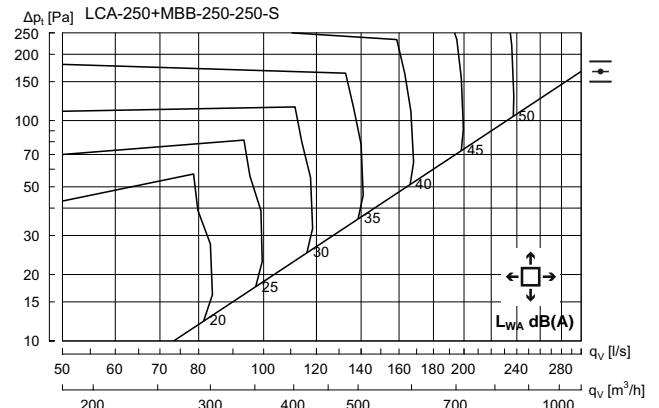

Hz	63	125	250	500	1K	2K	4K	8K
K_{ok}	12	3	-4	0	-4	-17	-24	-31

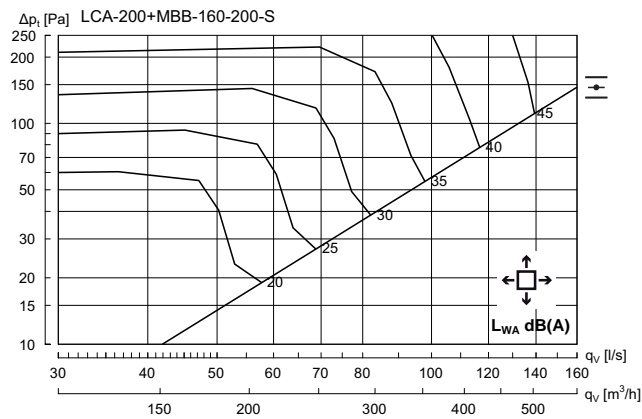

Hz	63	125	250	500	1K	2K	4K	8K
K_{ok}	12	9	0	-2	-6	-12	-19	-24

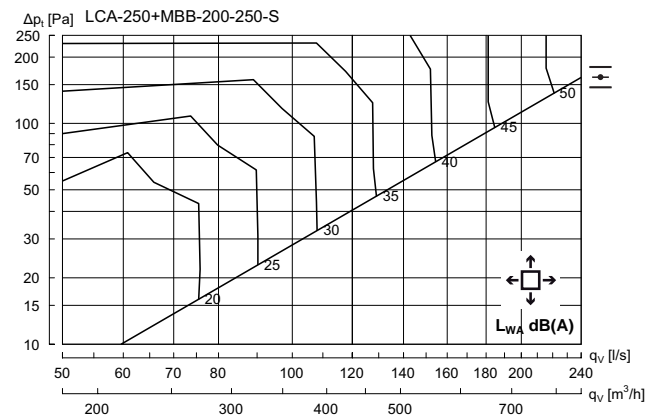

Hz	63	125	250	500	1K	2K	4K	8K
K_{ok}	12	6	-2	-1	-5	-14	-19	-23

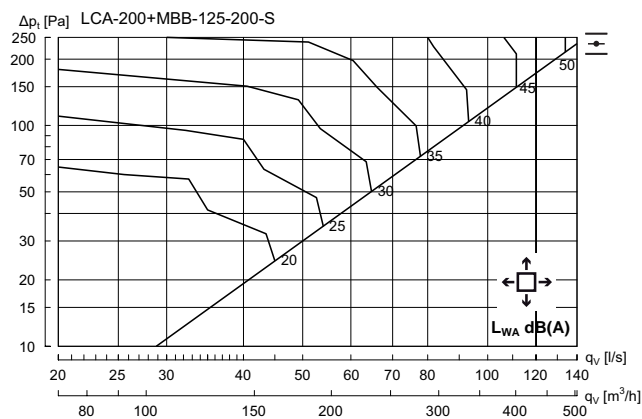

Hz	63	125	250	500	1K	2K	4K	8K
K_{ok}	12	7	1	-3	-6	-11	-15	-21

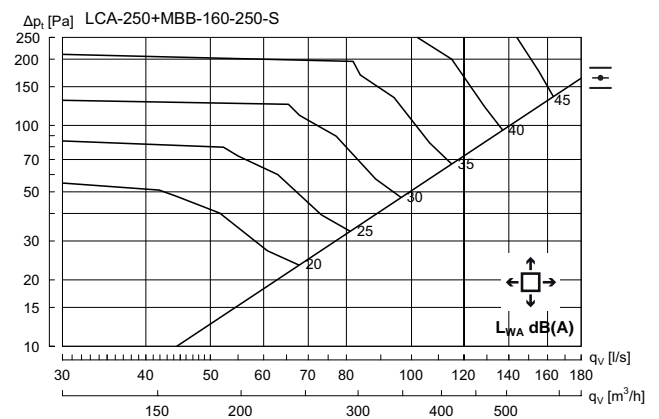

Hz	63	125	250	500	1K	2K	4K	8K
K_{ok}	9	7	-2	-3	-5	-10	-15	-21

Plain diffuser

LCA

Technical data

LCA 315 + MBB - Supply air

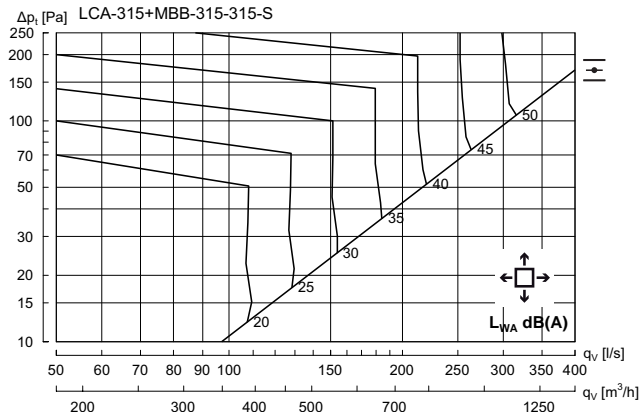

Hz	63	125	250	500	1K	2K	4K	8K
K_{ok}	13	5	-2	-1	-4	-17	-25	-36

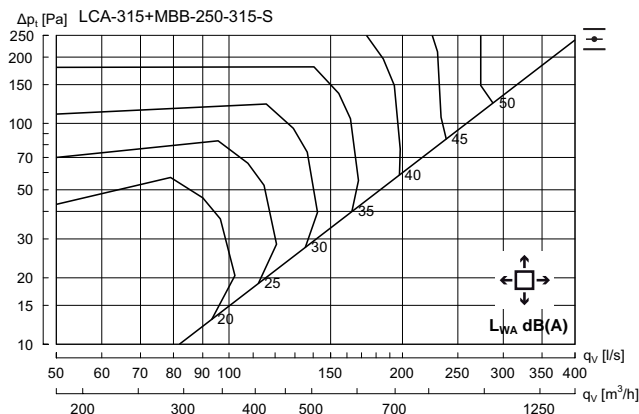

Hz	63	125	250	500	1K	2K	4K	8K
K_{ok}	14	5	-2	-2	-4	-13	-19	-26

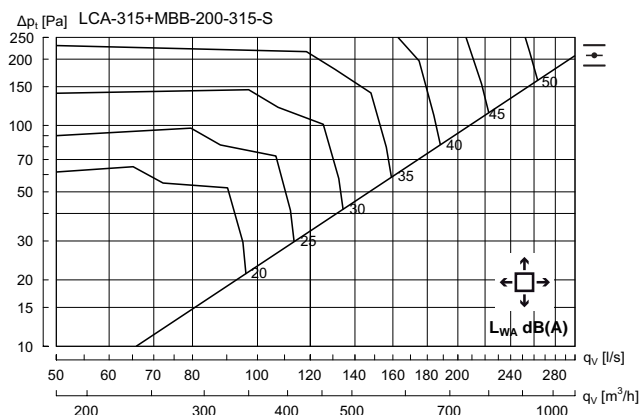

Hz	63	125	250	500	1K	2K	4K	8K
K_{ok}	13	6	-2	-3	-4	-11	-17	-22

LCA 400 + MBB - Supply air

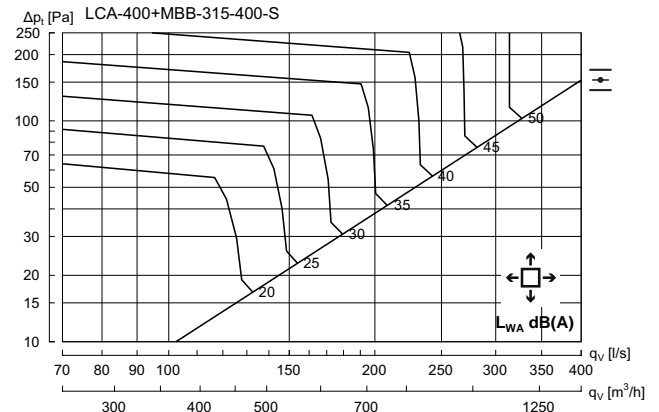

Hz	63	125	250	500	1K	2K	4K	8K
K_{ok}	14	6	1	-1	-6	-16	-21	-27

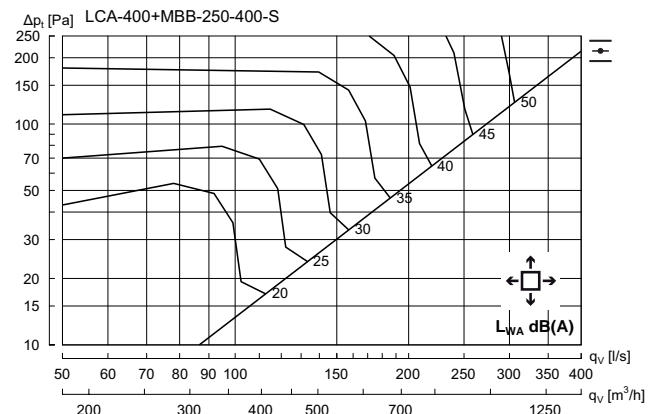

Hz	63	125	250	500	1K	2K	4K	8K
K_{ok}	12	7	0	-2	-6	-12	-19	-26

Correction sound power level (L_{WA}) and pressure loss (Δp_t)

LCA + MBB		1 - ways		2 - ways		3 - ways	
duct	LCA	L_{WA}	Δp_t	L_{WA}	Δp_t	L_{WA}	Δp_t
$\text{Ø}d_1$	$\text{Ø}d_2$						
100	100	+12	x 1,5	+8	x 1,2	+4	x 1,1
100	125	+10	x 1,3	+4	x 1,1	+2	x 1,05
100	160	+9	x 1,3	+2	x 1,1	+1	x 1
125	125	+12	x 1,5	+8	x 1,2	+4	x 1,1
125	160	+14	x 1,5	+7	x 1,2	+2	x 1,1
125	200	+9	x 1,4	+6	x 1,2	+3	x 1,1
160	160	+16	x 1,8	+9	x 1,3	+4	x 1,1
160	200	+21	x 1,9	+10	x 1,3	+4	x 1,1
160	250	+12	x 1,4	+6	x 1,1	+2	x 1,05
200	200	+24	x 2,5	+10	x 1,5	+5	x 1,2
200	250	+18	x 1,9	+7	x 1,2	+2	x 1,05
200	315	+17	x 1,6	+9	x 1,2	+3	x 1,1
250	250	+21	x 2,3	+10	x 1,4	+5	x 1,1
250	315	+20	x 1,9	+11	x 1,2	+5	x 1,2
250	400	+10	x 1,5	+6	x 1,2	+0	x 1
315	315	+21	x 2,4	+12	x 1,6	+6	x 1,2
315	400	+21	x 1,8	+8	x 1,5	+3	x 1,2

Plain diffuser

LCA

Technical data

LCA without box - Exhaust air

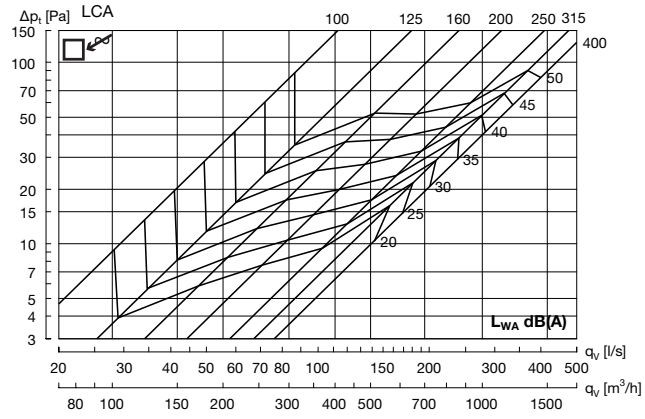

LCA 100 + MBB - Exhaust air

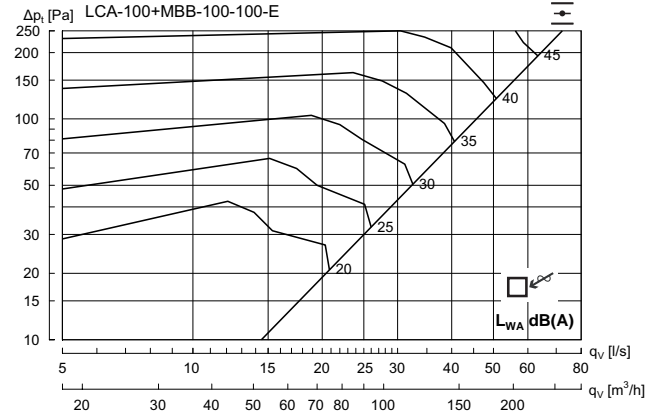

Hz	63	125	250	500	1K	2K	4K	8K
K_{ok}	13	1	3	-2	-7	-10	-15	-22

- 1
- 2
- 3
- 4
- 5
- 6
- 7
- 8
- 9
- 10
- 11
- 12
- 13
- 14
- 15
- 16
- 17
- 18

Plain diffuser

LCA

Technical data

LCA 125 + MBB - Exhaust air

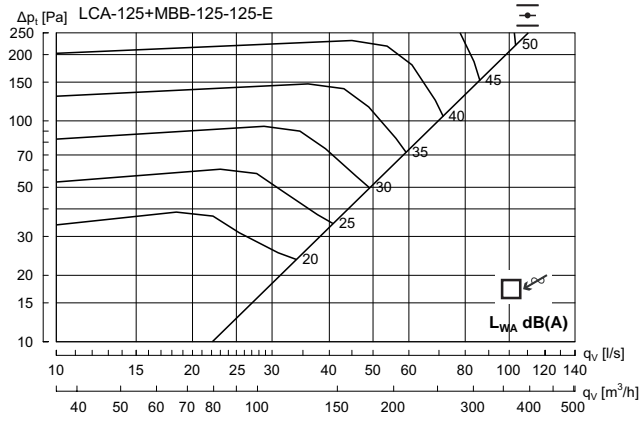

Hz	63	125	250	500	1K	2K	4K	8K
K_{ok}	13	4	1	-2	-5	-12	-15	-22

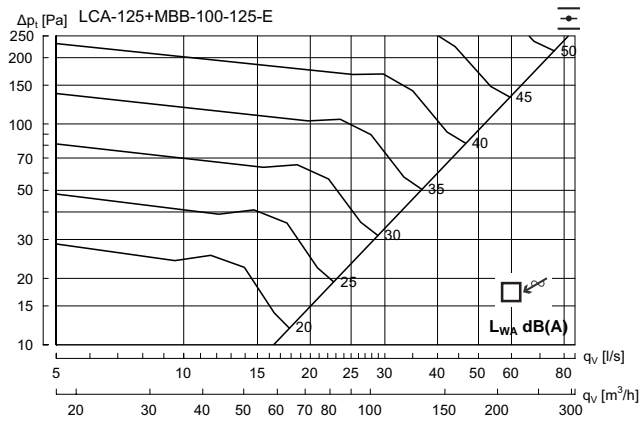

Hz	63	125	250	500	1K	2K	4K	8K
K_{ok}	13	0	4	-2	-8	-11	-16	-22

LCA 160 + MBB - Exhaust air

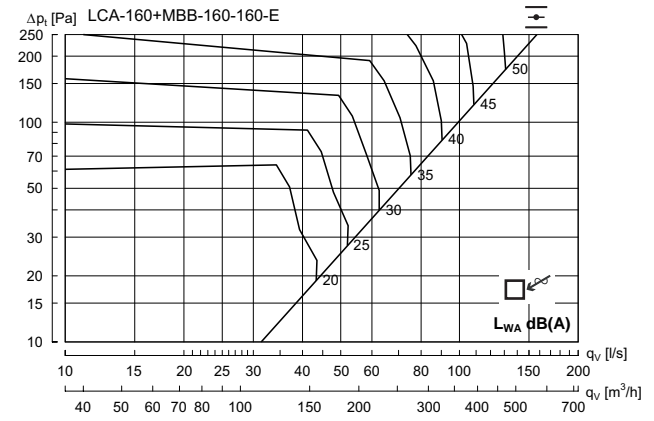

Hz	63	125	250	500	1K	2K	4K	8K
K_{ok}	16	6	1	-4	-5	-11	-17	-24

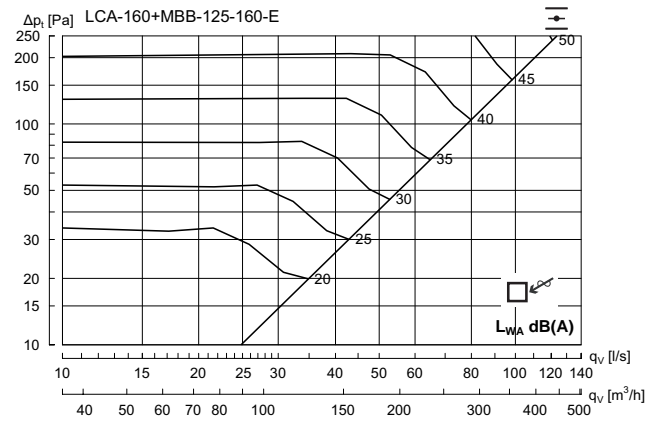

Hz	63	125	250	500	1K	2K	4K	8K
K_{ok}	12	6	2	-2	-7	-12	-14	-19

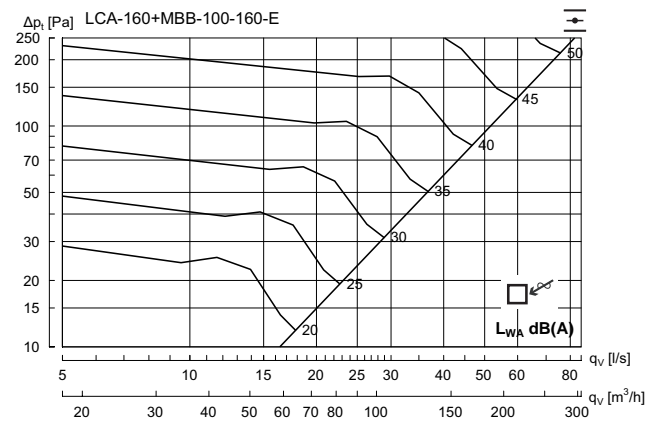

Hz	63	125	250	500	1K	2K	4K	8K
K_{ok}	11	-1	5	-2	-9	-13	-18	-24

Plain diffuser

LCA

Technical data

LCA 200 + MBB - Exhaust air

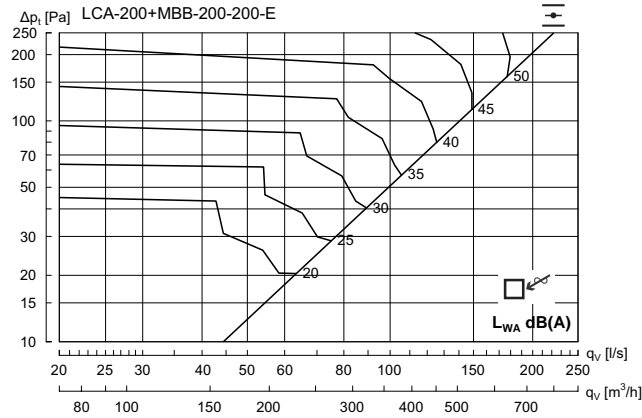

Hz	63	125	250	500	1K	2K	4K	8K
K_{vk}	14	6	0	-3	-5	-10	-19	-27

LCA 250 + MBB - Exhaust air

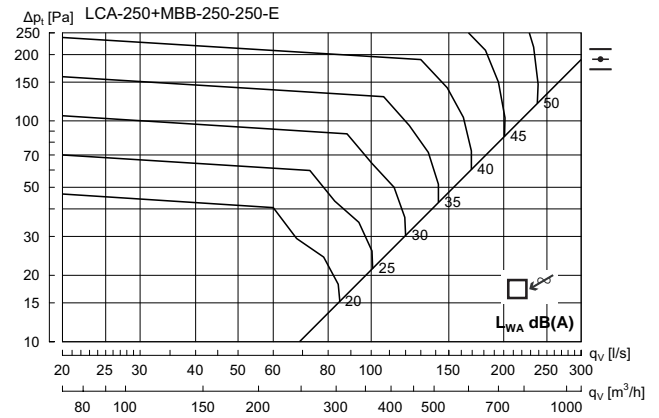

Hz	63	125	250	500	1K	2K	4K	8K
K_{vk}	12	4	-1	-3	-3	-12	-19	-30

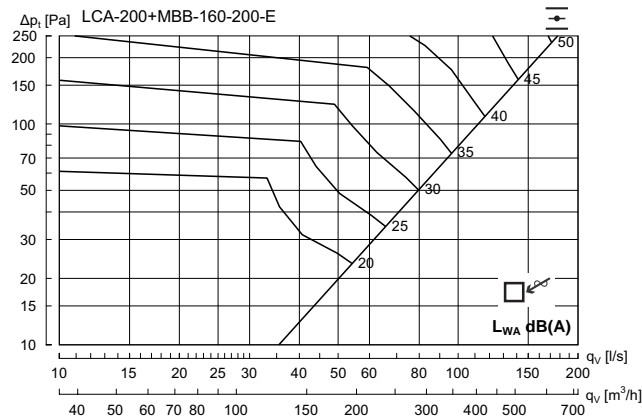

Hz	63	125	250	500	1K	2K	4K	8K
K_{vk}	16	7	-1	-4	-6	-10	-14	-20

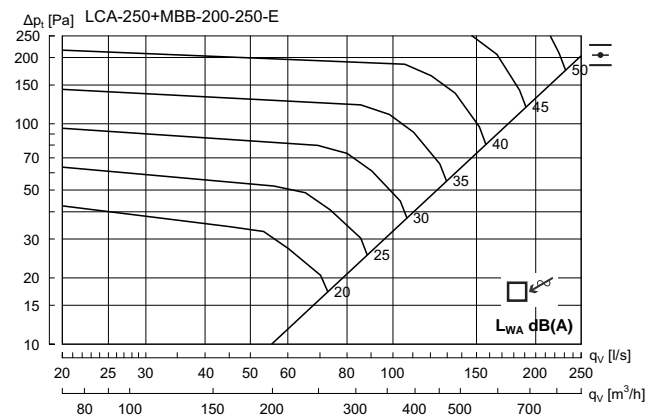

Hz	63	125	250	500	1K	2K	4K	8K
K_{vk}	13	3	-1	-3	-4	-11	-15	-24

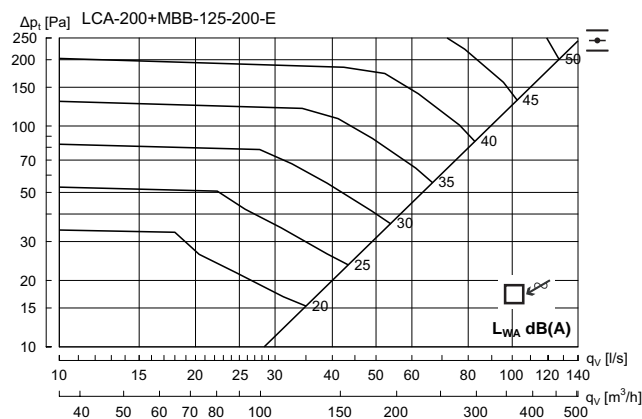

Hz	63	125	250	500	1K	2K	4K	8K
K_{vk}	11	3	0	-2	-5	-11	-14	-21

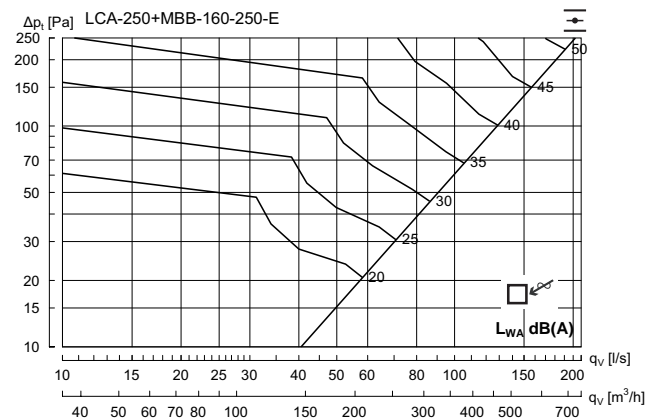

Hz	63	125	250	500	1K	2K	4K	8K
K_{vk}	14	6	0	-3	-5	-11	-15	-19

Plain diffuser

LCA

Technical data

LCA 315 + MBB - Exhaust air

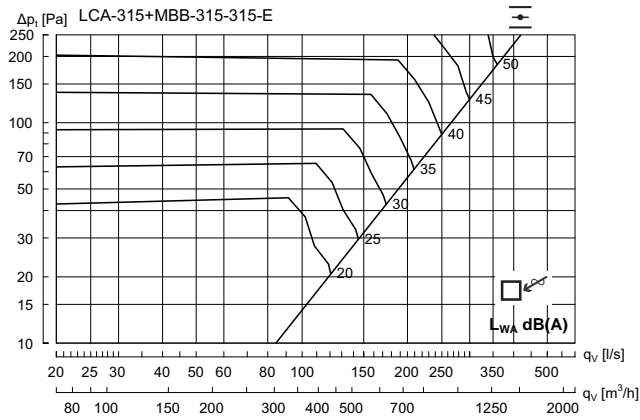

Hz	63	125	250	500	1K	2K	4K	8K
K_{sk}	13	5	2	-2	-6	-12	-17	-27

LCA 400 + MBB - Exhaust air

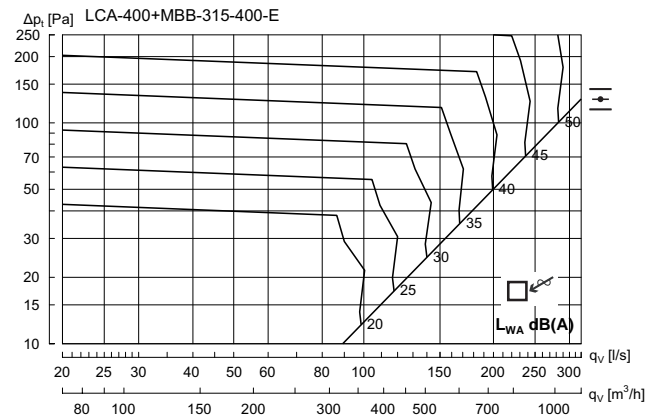

Hz	63	125	250	500	1K	2K	4K	8K
K_{sk}	10	5	0	0	-6	-15	-20	-27

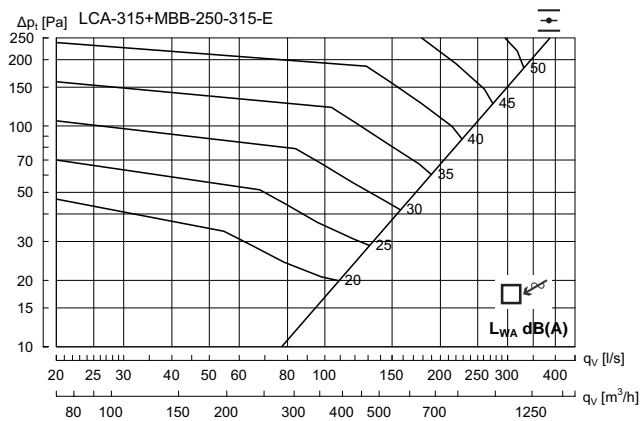

Hz	63	125	250	500	1K	2K	4K	8K
K_{sk}	10	5	1	-2	-6	-10	-16	-24

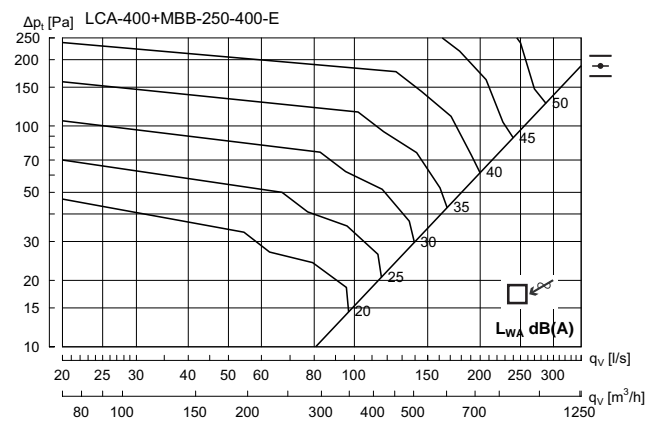

Hz	63	125	250	500	1K	2K	4K	8K
K_{sk}	12	5	1	-1	-7	-12	-16	-24

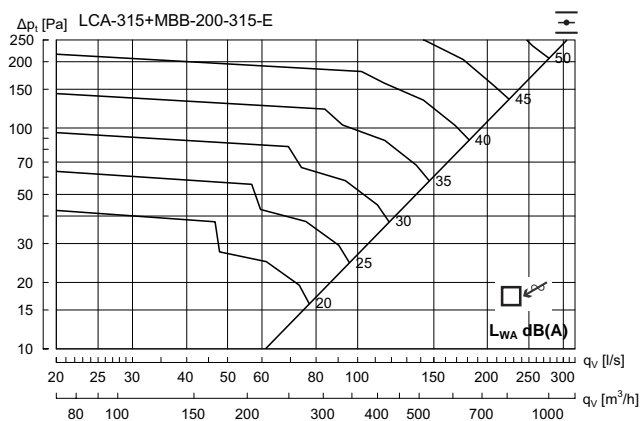

Hz	63	125	250	500	1K	2K	4K	8K
K_{sk}	14	5	0	-2	-6	-12	-14	-22



Plain diffuser

CRL



Description

CRL is a circular diffuser with an unperforated adjustable face plate. CRL can be used both for supply and exhaust air. The diffuser can be switched between horizontal and vertical supply air, and is therefore suitable for the horizontal supply of cooled air or vertical supply of heated air. Installing a CRL diffuser in a plenum box type MBB can help to achieve a stable airflow to the diffuser as well as realise the potential for individual adjustment. It is also possible to install a damper directly in the diffuser to enable adjustment without a box.

- Suitable for both supply and exhaust air
- Suitable for horizontal or vertical supply air patterns
- A damper can be installed on the diffuser to achieve adjustment

Maintenance

The face plate can be removed to enable cleaning of internal parts or to gain access to the duct or plenum box. The visible parts of the diffuser can be wiped with a damp cloth.

Order code

Product Type CRL	CRL	aaa
Connection dim. Ød Ød 100-400		

Example: CRL-200

Dimensions

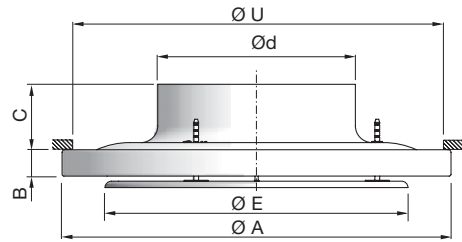

CRL Ød	ØA	B	C	ØE	ØU*	Weight
mm	mm	mm	mm	mm	mm	kg
100	188	15	60	146	170	0.30
125	238	20	65	180	210	0.50
160	288	25	65	220	255	0.60
200	388	28	72	300	355	1.10
250	488	33	82	380	390	1.60
315	588	33	97	490	465	2.50
400	720	40	100	590	670	3.80

* ØU = Ceiling grid opening

Dispersal patterns

CRL is supplied with vertical supply air as standard. The dispersal pattern can be changed to horizontal supply air by moving the face plate.

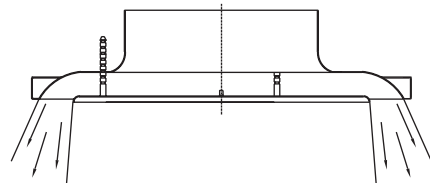

Vertical supply air.

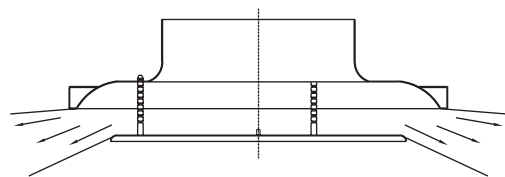

Horizontal supply air.

Materials and finish:

Grille box: Aluminium
 Face plate: Galvanised steel
 Standard finish: Powder-coated
 Standard colour: White RAL 9010, gloss 30

The diffuser is available in other colours. Please contact Lindab's sales department for further information.

Plain diffuser

CRL

Accessories

CAZ - Balancing damper

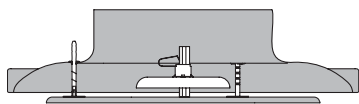

MBZ - Extension piece



DCZ - Mounting brackets (set)

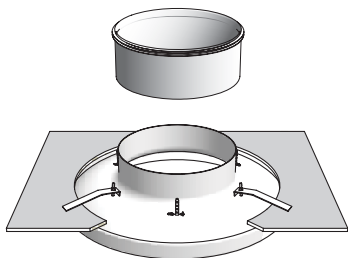

Order code - accessoires

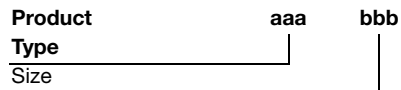

Example: CAZ-125

MBB - Plenum box



CRL + MBB

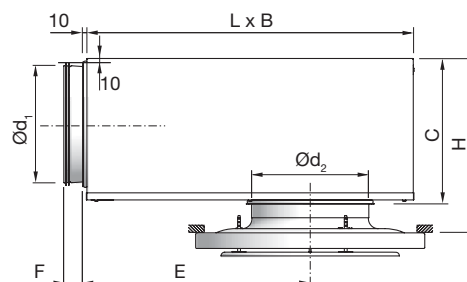

CRL + MBB		B mm	C mm	E mm	F mm	H* mm	L mm
duct Ød ₁ mm	CRL Ød ₂ mm						
100	100	260	159	216	50	175 - 210	310
100	125	260	159	216	50	175 - 205	310
100	160	260	159	216	50	175 - 205	310
125	125	310	184	262	50	200 - 230	376
125	160	310	184	262	50	200 - 230	376
125	200	310	184	262	50	210 - 245	376
160	160	380	220	323	50	235 - 265	459
160	200	380	220	323	50	245 - 280	459
160	250	380	220	323	50	250 - 290	459
200	200	460	259	396	70	285 - 320	565
200	250	460	259	396	70	290 - 332	565
200	315	460	259	396	70	290 - 345	565
250	250	540	309	486	70	340 - 380	698
250	315	540	309	486	70	340 - 395	698
250	400	540	309	486	70	370 - 400	698
315	315	540	373	646	70	405 - 460	858
315	400	540	373	646	70	435 - 465	858

USING CRL + MBB => ALWAYS USE MBZ

* Using accessory MBZ the H dimension will increase:

Ød₂ = 100 - 200 mm => H +40 mm

Ød₂ = 250 - 315 mm => H +60 mm

Ød₂ = 400 mm => H +80 mm

Order code

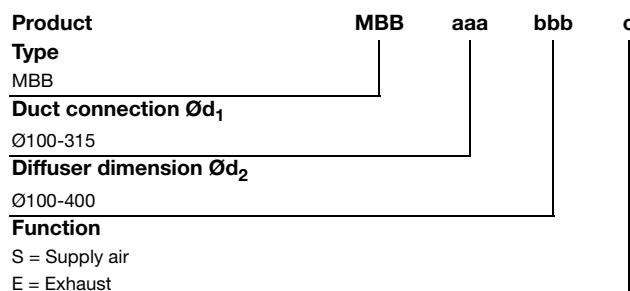

Example: CRL-200+MBB-160-200-S

Plain diffuser

CRL

Technical data

Capacity

Air flow q_v [l/s] and [m³/h], total pressure Δp_t [Pa], throw $l_{0,2}$ [m] and sound power level L_{WA} [dB(A)] can be seen in the diagrams.

Frequency-related sound effect level

The sound effect level in the frequency band is defined as $L_{WA} + K_{ok}$. K_{ok} values are specified in charts beneath the diagrams and on the following pages. K_{ok} values for CRL without a box are available on request.

Quick selection, supply air

CRL + MBB		$\Delta p_t \geq 50$ Pa 30 dB(A)		$\Delta p_t \geq 50$ Pa 35 dB(A)	
duct $\varnothing d_1$	CRL $\varnothing d_2$	l/s	m ³ /h	l/s	m ³ /h
100	100	26	94	31	112
100	125	35	126	42	151
100	160	42	151	50	180
125	125	46	166	54	194
125	160	58	209	68	245
125	200	62	223	75	270
160	160	67	241	81	292
160	200	86	310	105	378
160	250	96	346	121	436
200	200	107	385	127	457
200	250	135	486	160	576
200	315	146	526	177	637
250	250	151	544	183	659
250	315	161	580	215	774
250	400	185	666	252	907
315	315	206	742	263	947
315	400	227	817	309	1112

Sound attenuation

Sound attenuation of the diffuser ΔL from duct to room, including end reflection, see table below.

CRL + MBB		Centre frequency Hz							
duct $\varnothing d_1$	CRL $\varnothing d_2$	63	125	250	500	1K	2K	4K	8K
100	100	20	17	7	20	19	20	20	22
100	125	21	16	6	18	19	18	19	21
100	160	21	16	5	15	17	18	18	18
125	125	18	13	7	20	12	19	19	20
125	160	15	14	8	19	12	17	17	19
125	200	14	12	6	16	14	16	17	16
160	160	18	17	10	18	16	18	21	20
160	200	15	14	7	19	17	18	19	19
160	250	15	15	4	15	13	14	16	18
200	200	14	10	7	14	19	16	20	17
200	250	15	9	5	14	19	16	17	16
200	315	13	8	4	11	16	15	16	15
250	250	16	8	7	16	18	18	18	17
250	315	11	7	6	16	17	17	16	16
250	400	15	6	5	10	14	16	15	15
315	315	8	10	9	14	18	18	17	21
315	400	8	8	8	11	16	17	16	19

Throw $l_{0,2}$

The throw is specified at a terminal velocity of 0.2 m/s. Diagram below shows throw $l_{0,2}$ for horizontal supply air.

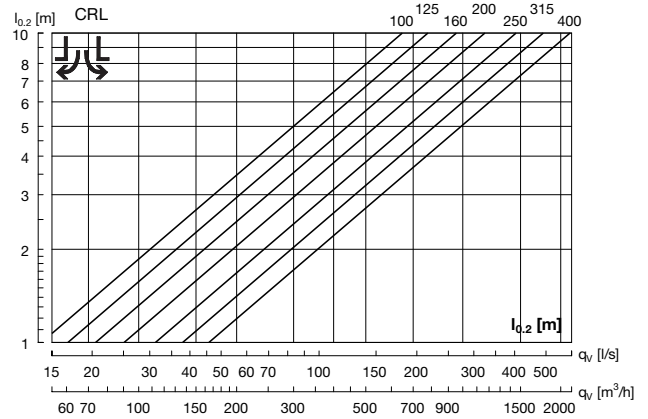

Correction throw $l_{0,2}$ for vertical supply air

CRL $\varnothing d$	Correction factor
100	3,1
125	2,7
160	2,7
200	2,7
250	2,6
315	2,4
400	2,3

Air jet distribution

l_b = Distance from the diffuser to the point where there is maximum dispersal.

b_v = Depth of the air jet on a vertical plane.

b_h = Width of the air jet on a horizontal plane

Horizontal supply air pattern

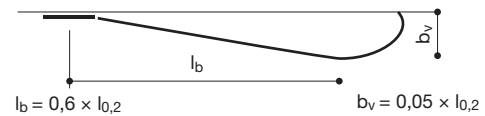

Vertical supply air pattern

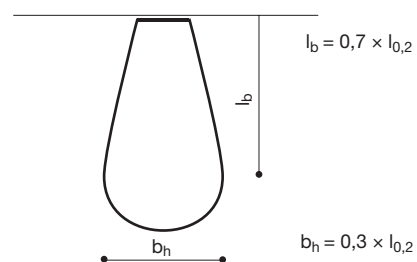

Plain diffuser

CRL

Technical data

Throw $l_{0,2}$ / turning point $l_{0,0}$

Throw $l_{0,2}$ [m] is specified at a speed of 0.2 m/s. Turning point $l_{0,0}$ [m] is specified for +5 K, +10 K respectively.

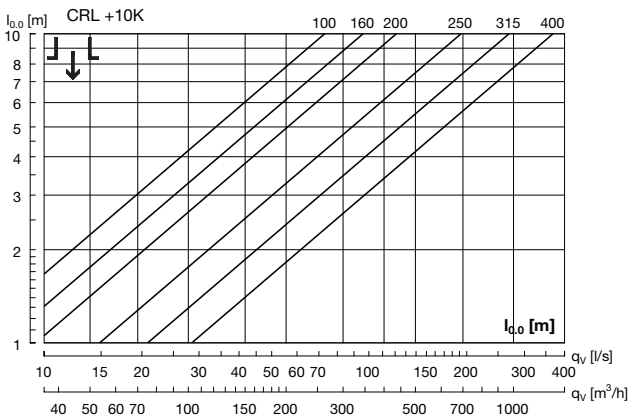
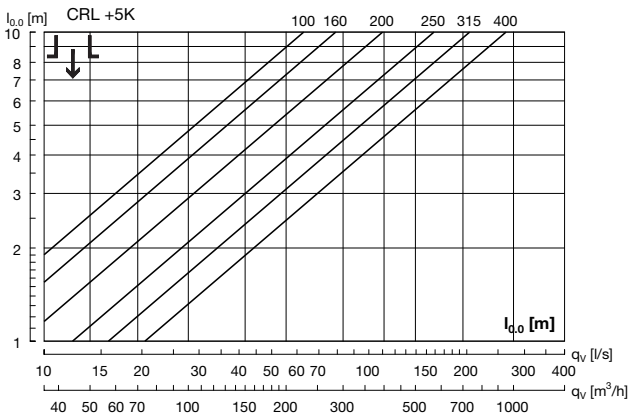
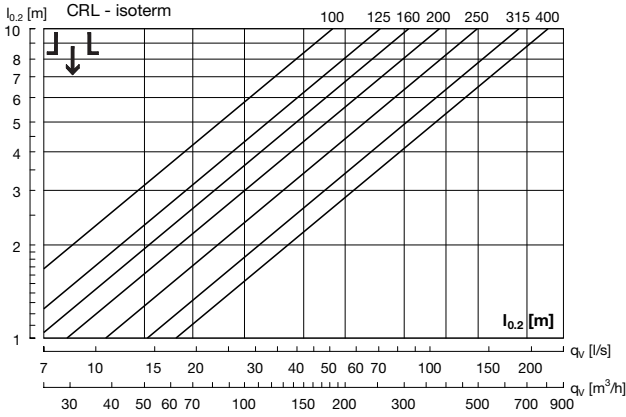

CRL without box - Supply air

Supply air - horizontal

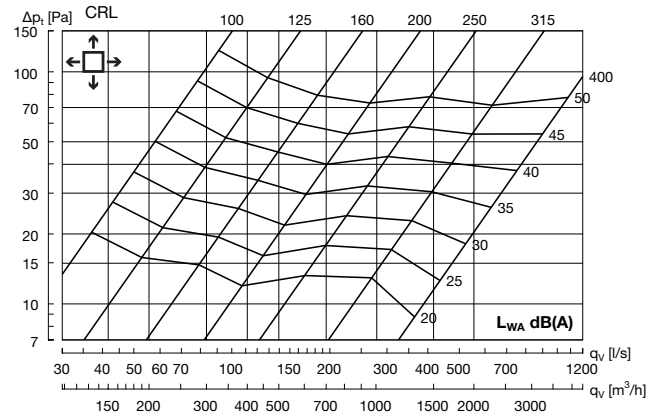

Supply air - vertical

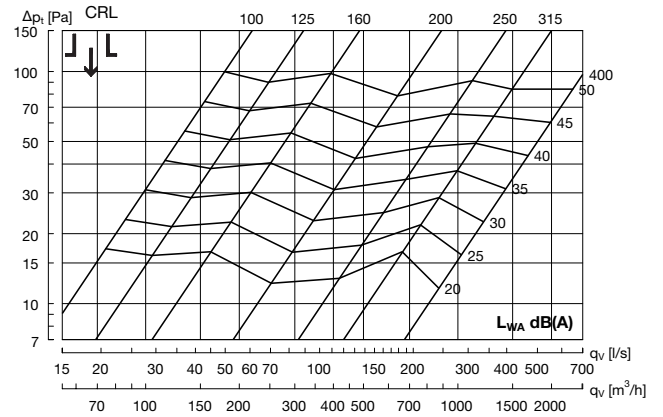

Plain diffuser

CRL

Technical data

CRL 100 + MBB - Supply air

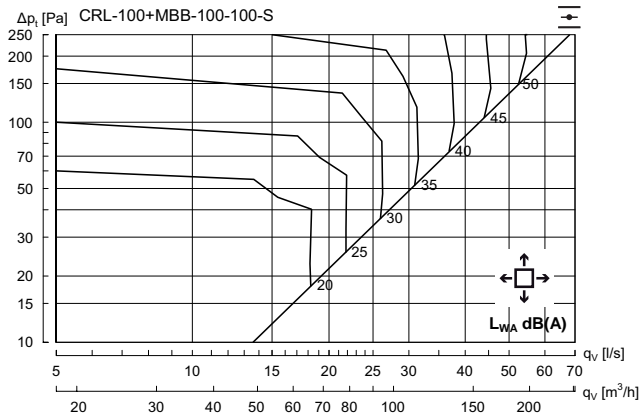

Hz	63	125	250	500	1K	2K	4K	8K
K_{ok}	12	8	5	-7	-8	-14	-17	-22

CRL 125 + MBB - Supply air

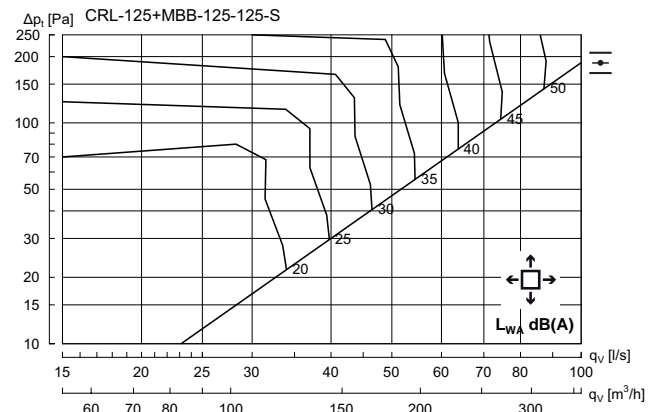

Hz	63	125	250	500	1K	2K	4K	8K
K_{ok}	11	9	3	-5	-6	-14	-20	-24

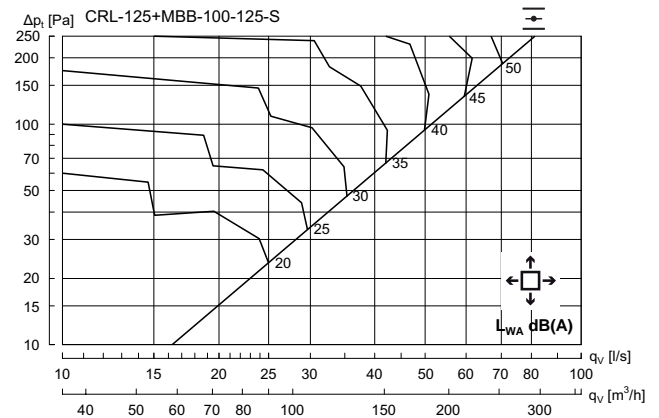

Hz	63	125	250	500	1K	2K	4K	8K
K_{ok}	13	8	3	-5	-7	-11	-15	-19



Plain diffuser

CRL

Technical data

CRL 160 + MBB - Supply air

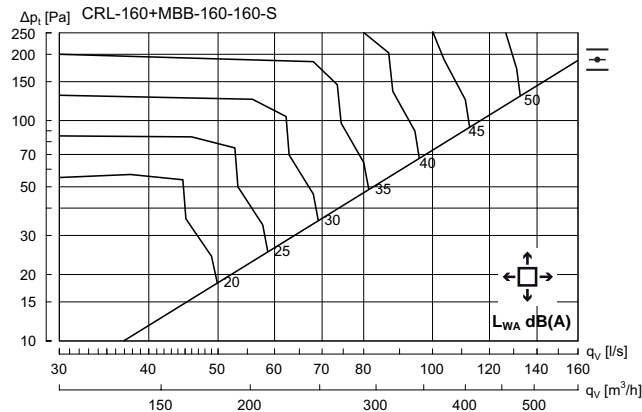

Hz	63	125	250	500	1K	2K	4K	8K
K_{ok}	11	12	3	-7	-7	-15	-20	-23

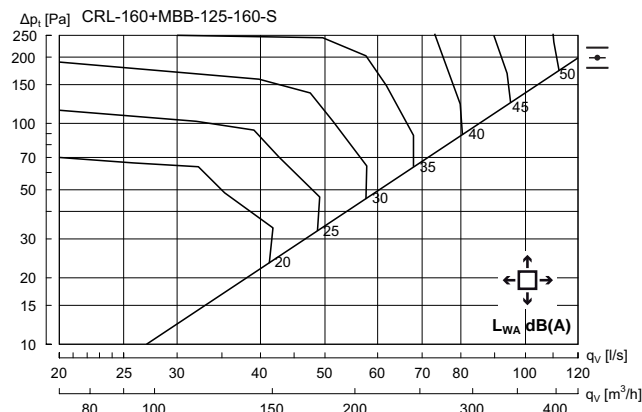

Hz	63	125	250	500	1K	2K	4K	8K
K_{ok}	12	8	3	-5	-6	-11	-17	-22

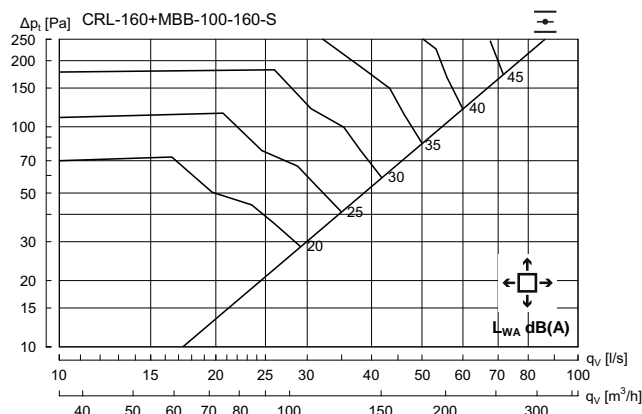

Hz	63	125	250	500	1K	2K	4K	8K
K_{ok}	9	3	1	-3	-5	-9	-15	-19

CRL 200 + MBB - Supply air

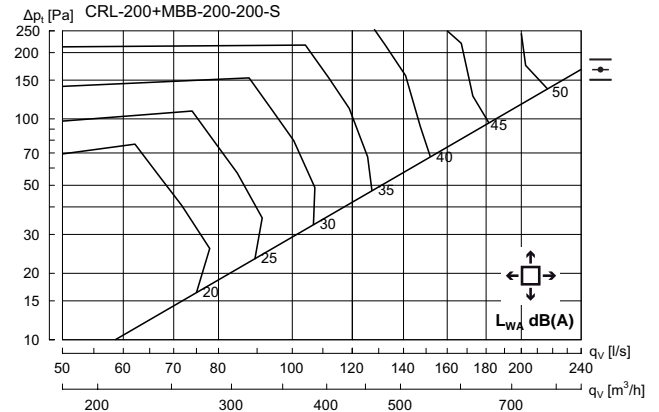

Hz	63	125	250	500	1K	2K	4K	8K
K_{ok}	12	11	1	-3	-7	-15	-20	-24

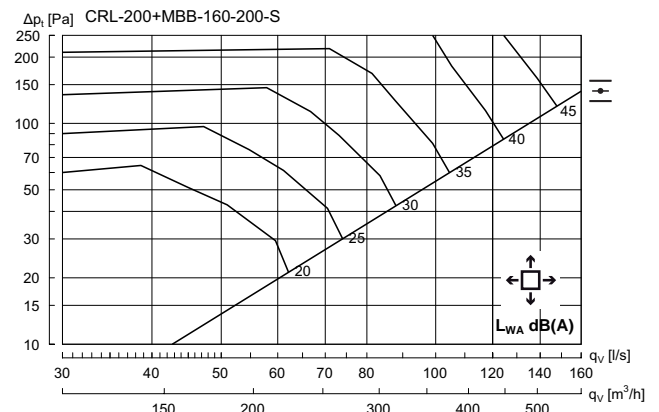

Hz	63	125	250	500	1K	2K	4K	8K
K_{ok}	12	8	1	-4	-5	-10	-18	-22

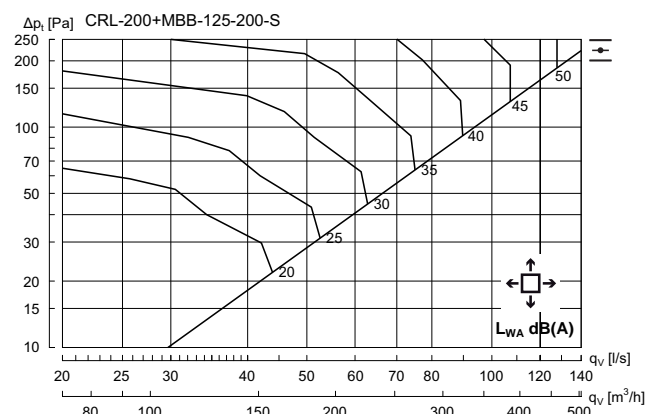

Hz	63	125	250	500	1K	2K	4K	8K
K_{ok}	10	5	1	-4	-5	-10	-16	-20

Plain diffuser

CRL

Technical data

CRL 250+ MBB - Supply air

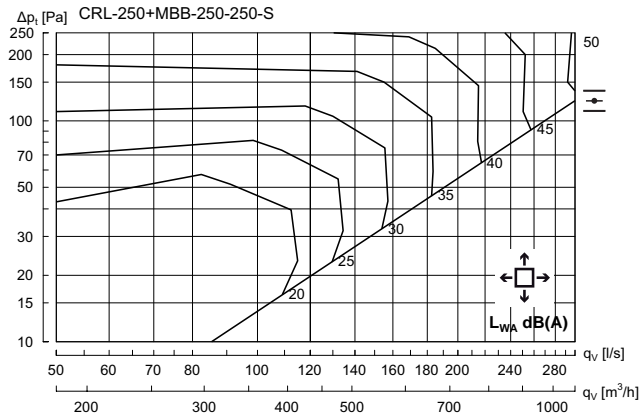

Hz	63	125	250	500	1K	2K	4K	8K
K_{ok}	15	7	0	-2	-6	-12	-16	-21

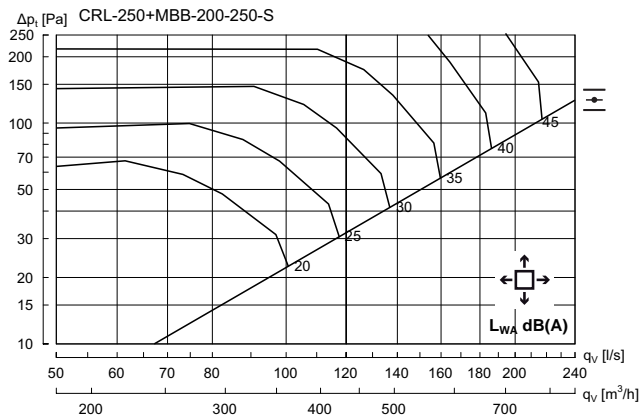

Hz	63	125	250	500	1K	2K	4K	8K
K_{ok}	11	7	-1	-2	-5	-12	-17	-22

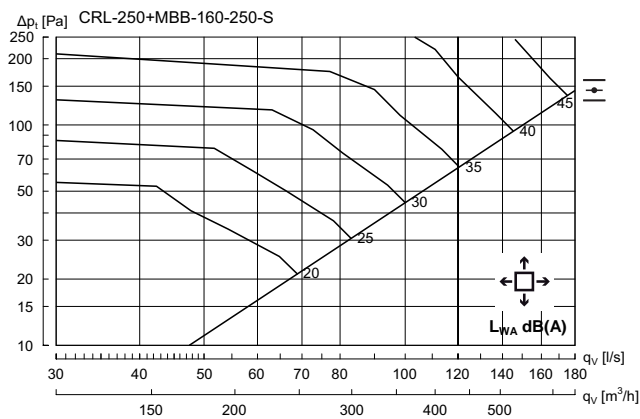

Hz	63	125	250	500	1K	2K	4K	8K
K_{ok}	11	6	1	-3	-5	-10	-15	-21

CRL 315 + MBB - Supply air

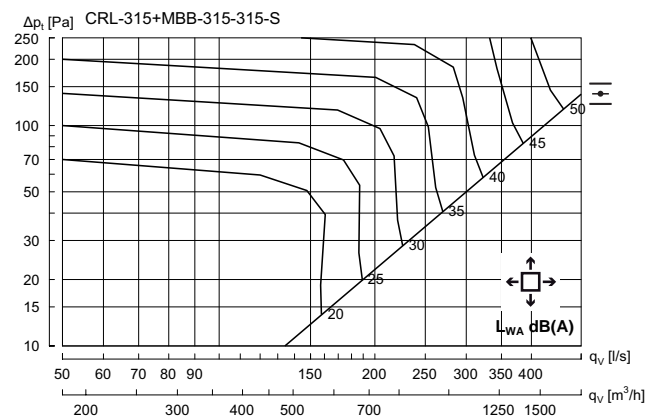

Hz	63	125	250	500	1K	2K	4K	8K
K_{ok}	15	4	1	-2	-6	-13	-17	-16

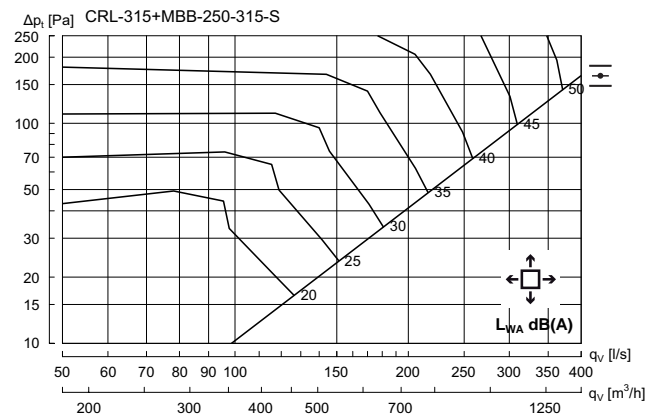

Hz	63	125	250	500	1K	2K	4K	8K
K_{ok}	13	6	-1	-2	-5	-12	-17	-23

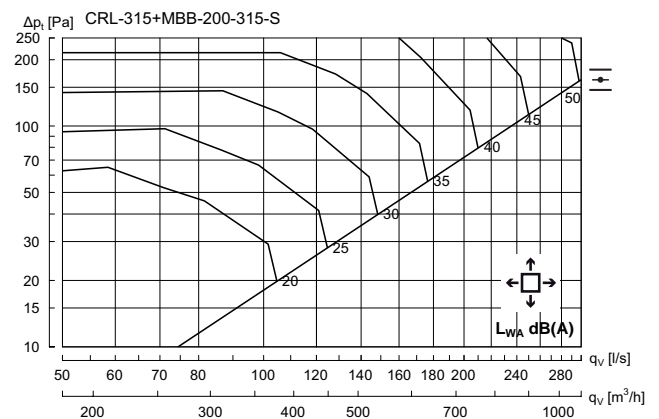

Hz	63	125	250	500	1K	2K	4K	8K
K_{ok}	11	7	0	-3	-6	-10	-16	-21

Plain diffuser

CRL

Technical data

CRL 400+ MBB - Supply air

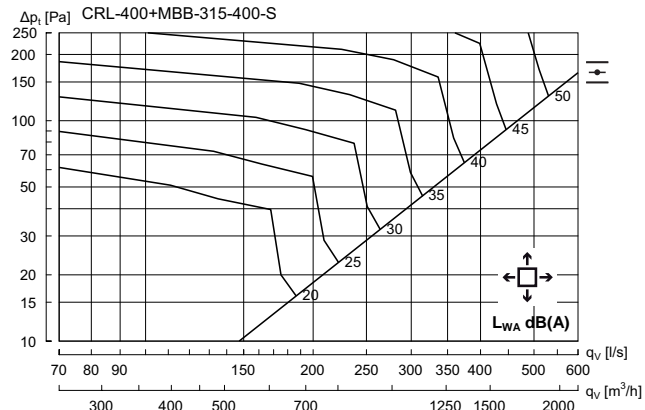

Hz	63	125	250	500	1K	2K	4K	8K
K_{sk}	11	3	0	-3	-5	-10	-14	-23

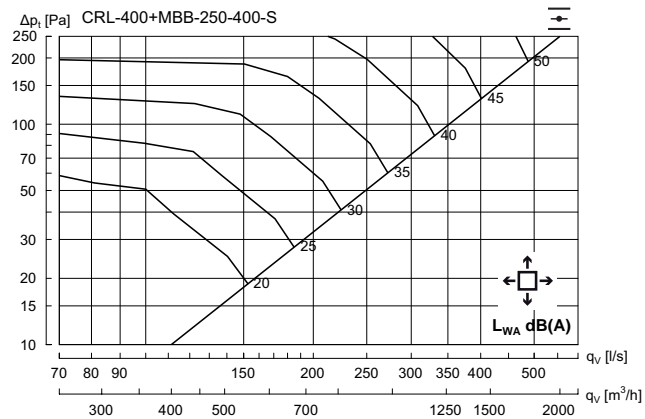

Hz	63	125	250	500	1K	2K	4K	8K
K_{sk}	8	4	-1	-3	-4	-10	-14	-20

CRL + MBB - Supply air

Correction vertical supply air, sound power level (L_{WA}) and pressure loss (Δp_t)

CRL + MBB		Correction factor	
duct	CRL	Vertical supply air	
$\varnothing d_1$	$\varnothing d_2$	L_{WA}	Δp_t
100	100	+ 6	x 1,3
100	125	+ 8	x 1,3
100	160	+ 3	x 1,1
125	125	+ 1	x 1
125	160	+ 8	x 1,2
125	200	+ 1	x 1
160	160	+ 10	x 1,5
160	200	+ 3	x 1,1
160	250	+ 0	x 1
200	200	+ 7	x 1,3
200	250	+ 0	x 1
200	315	+ 1	x 1
250	250	+ -2	x 1
250	315	+ 0	x 1
250	400	+ 0	x 1,1
315	315	+ -2	x 1,1
315	400	+ 3	x 1,2

Plain diffuser

CRL

Technical data

CRL without box - Exhaust air

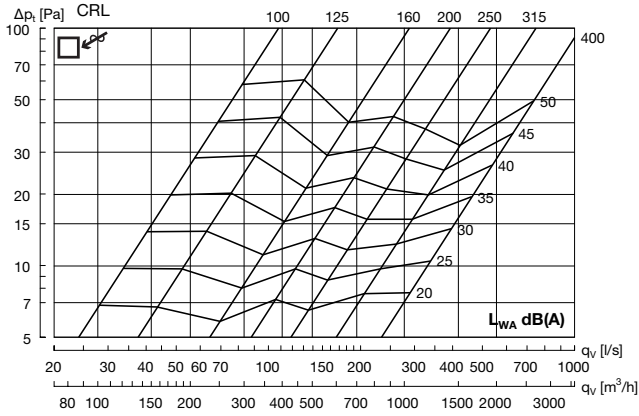

CRL 100 + MBB - Exhaust air

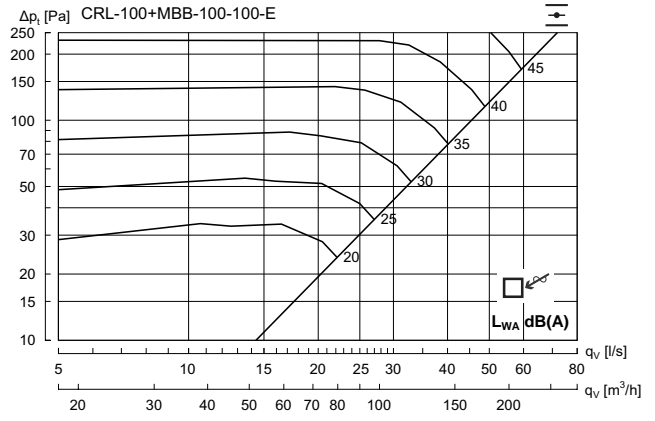

Hz	63	125	250	500	1K	2K	4K	8K
K_{ok}	11	0	2	-2	-6	-11	-15	-22

- 1
- 2
- 3
- 4
- 5
- 6
- 7
- 8
- 9
- 10
- 11
- 12
- 13
- 14
- 15
- 16
- 17
- 18

Plain diffuser

CRL

Technical data

CRL 125 + MBB - Exhaust air

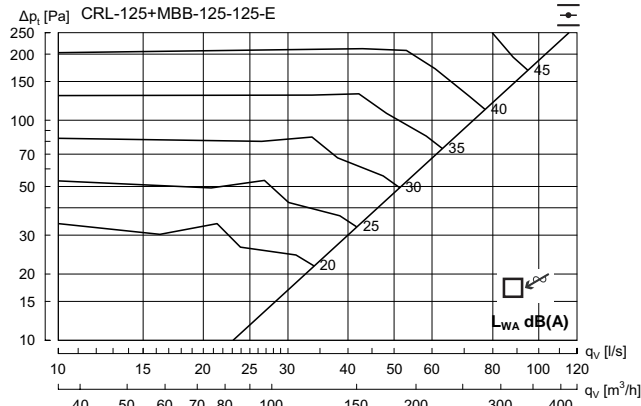

Hz	63	125	250	500	1K	2K	4K	8K
K_{ok}	14	5	-1	-3	-4	-12	-15	-21

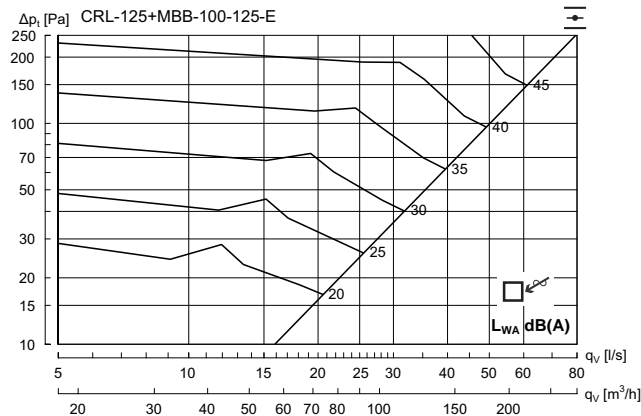

Hz	63	125	250	500	1K	2K	4K	8K
K_{ok}	13	0	4	-3	-8	-11	-17	-22

CRL 160 + MBB - Exhaust air

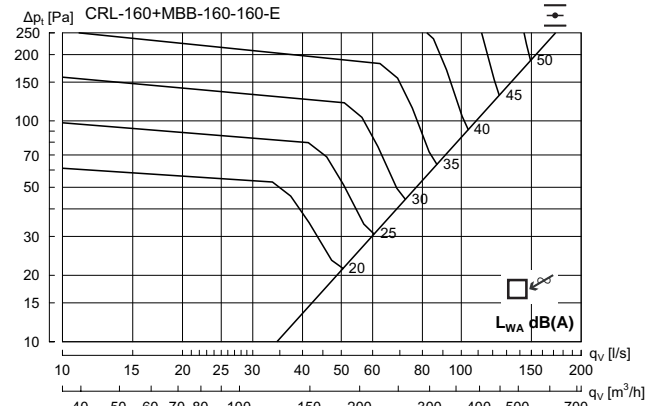

Hz	63	125	250	500	1K	2K	4K	8K
K_{ok}	14	4	-1	-4	-4	-10	-16	-24

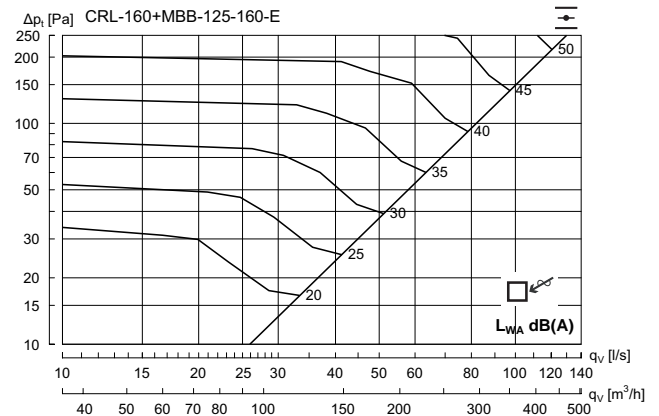

Hz	63	125	250	500	1K	2K	4K	8K
K_{ok}	13	6	1	-3	-5	-12	-15	-21

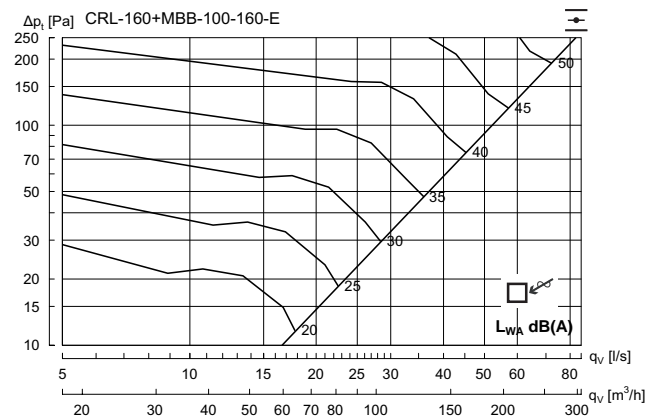

Hz	63	125	250	500	1K	2K	4K	8K
K_{ok}	13	0	5	-3	-9	-12	-19	-23

Plain diffuser

CRL

Technical data

CRL 200 + MBB - Exhaust air

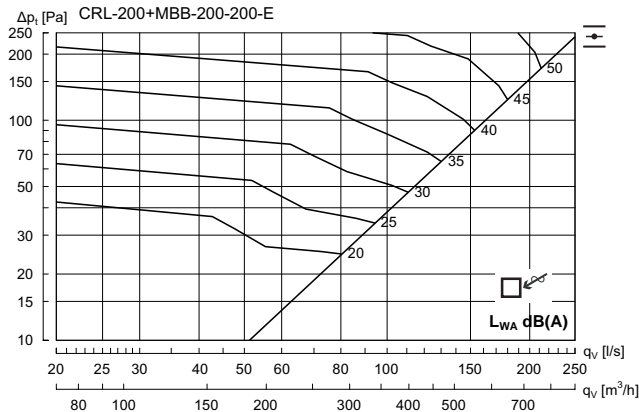

Hz	63	125	250	500	1K	2K	4K	8K
K_{ok}	15	5	-1	-3	-6	-9	-16	-25

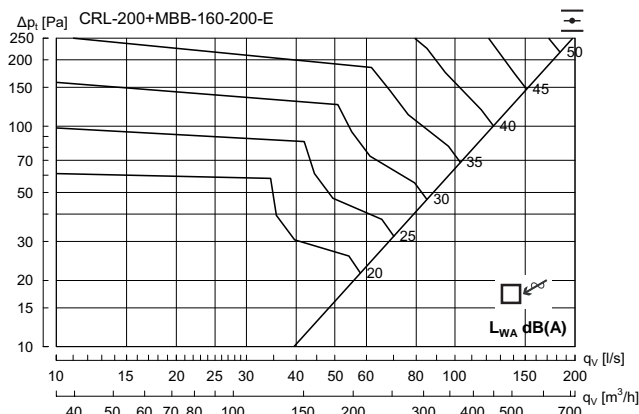

Hz	63	125	250	500	1K	2K	4K	8K
K_{ok}	14	5	0	-3	-5	-9	-15	-20

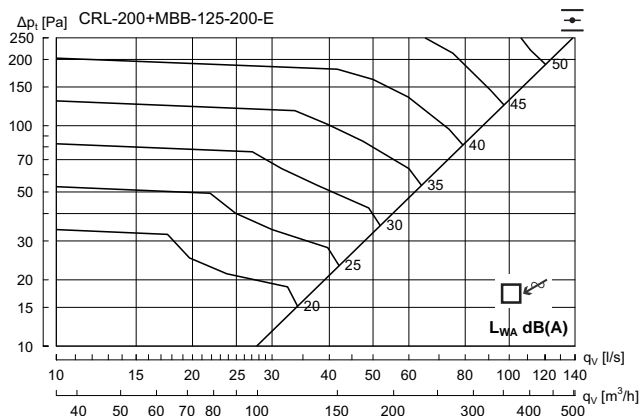

Hz	63	125	250	500	1K	2K	4K	8K
K_{ok}	9	2	1	-2	-5	-9	-14	-19

CRL 250 + MBB - Exhaust air

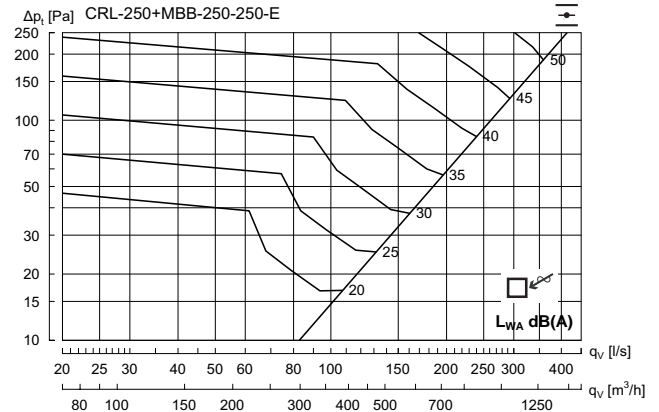

Hz	63	125	250	500	1K	2K	4K	8K
K_{ok}	11	6	2	-2	-7	-11	-15	-24

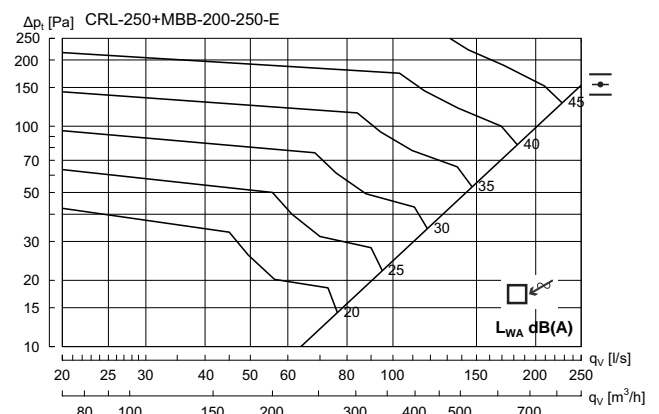

Hz	63	125	250	500	1K	2K	4K	8K
K_{ok}	13	5	1	-3	-6	-10	-13	-22

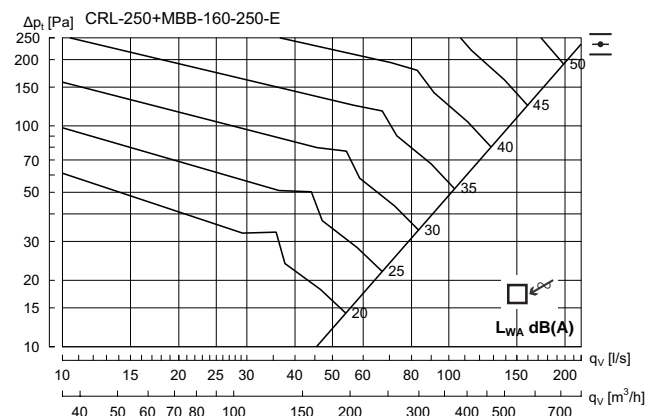

Hz	63	125	250	500	1K	2K	4K	8K
K_{ok}	13	5	1	-3	-5	-11	-14	-20



Plain diffuser

CRL

Technical data

CRL 315 + MBB - Exhaust air

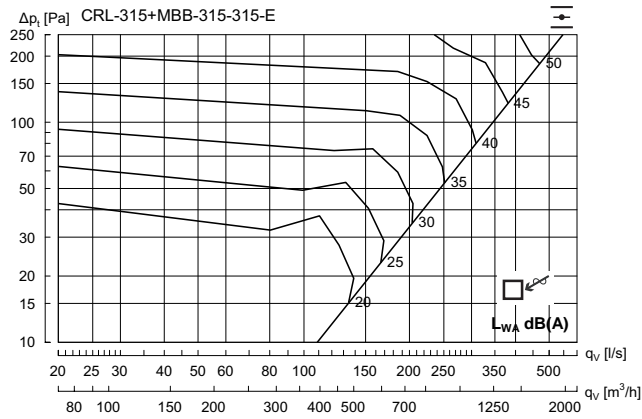

Hz	63	125	250	500	1K	2K	4K	8K
K_{ok}	13	5	2	-3	-6	-10	-15	-25

CRL 400 + MBB - Exhaust air

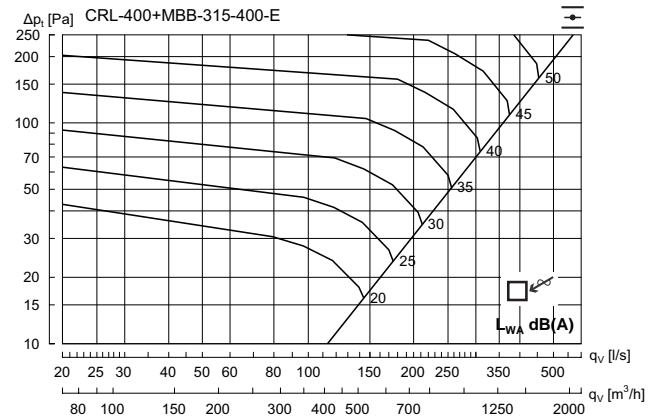

Hz	63	125	250	500	1K	2K	4K	8K
K_{ok}	11	5	2	-2	-7	-11	-15	-25

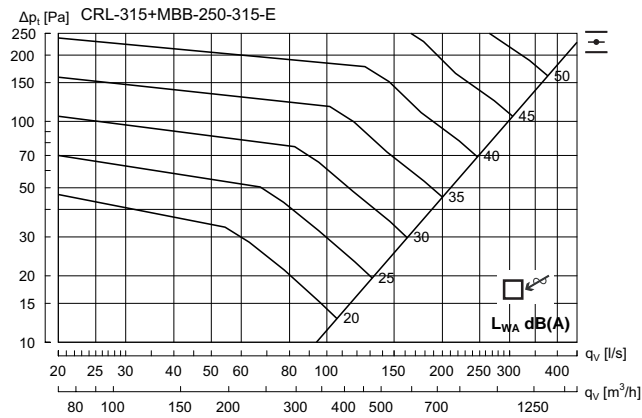

Hz	63	125	250	500	1K	2K	4K	8K
K_{ok}	9	5	2	-3	-6	-10	-16	-22

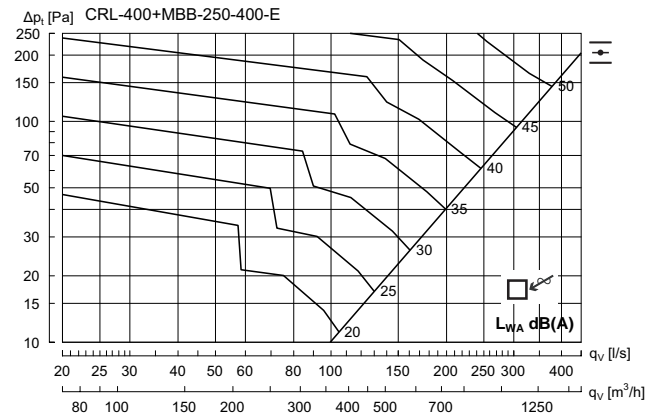

Hz	63	125	250	500	1K	2K	4K	8K
K_{ok}	9	6	2	-2	-6	-12	-16	-24

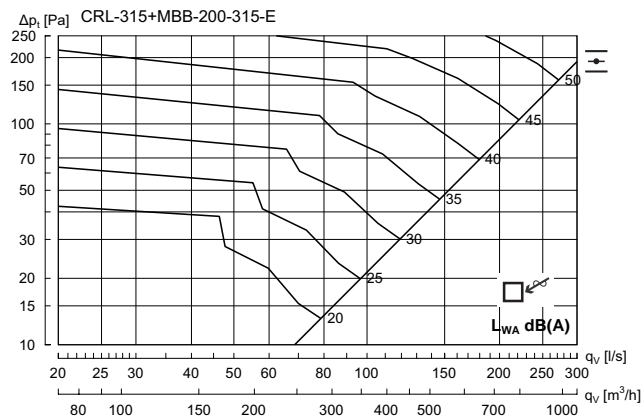

Hz	63	125	250	500	1K	2K	4K	8K
K_{ok}	13	5	0	-3	-5	-10	-15	-22

Lindab Integra













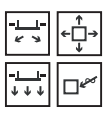

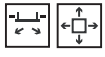

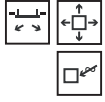

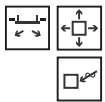
- 1
- 2
- 3
- 4
- 5**
- 6
- 7
- 8
- 9
- 10
- 11
- 12
- 13
- 14
- 15
- 16
- 17
- 18

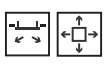
PC7, Integrated in Luxalon Clip-In ceiling with adapted module plate type LM.

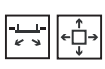
Lindab Integra a series of flush diffusers

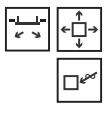
Mixed ventilation diffusers

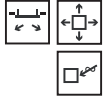
- 1
- 2
- 3
- 4
- 5
- 6
- 7
- 8
- 9
- 10
- 11
- 12
- 13
- 14
- 15
- 16
- 17
- 18

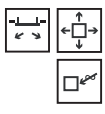
		Product	Functions	Page
		PC6		125
		PC7		135
		RC14		141
		RC15		151
		NC19		161
		RCG		169
		LCC		176
		LCP		177
		LKP		177

Lindab Integra

a series of flush diffusers

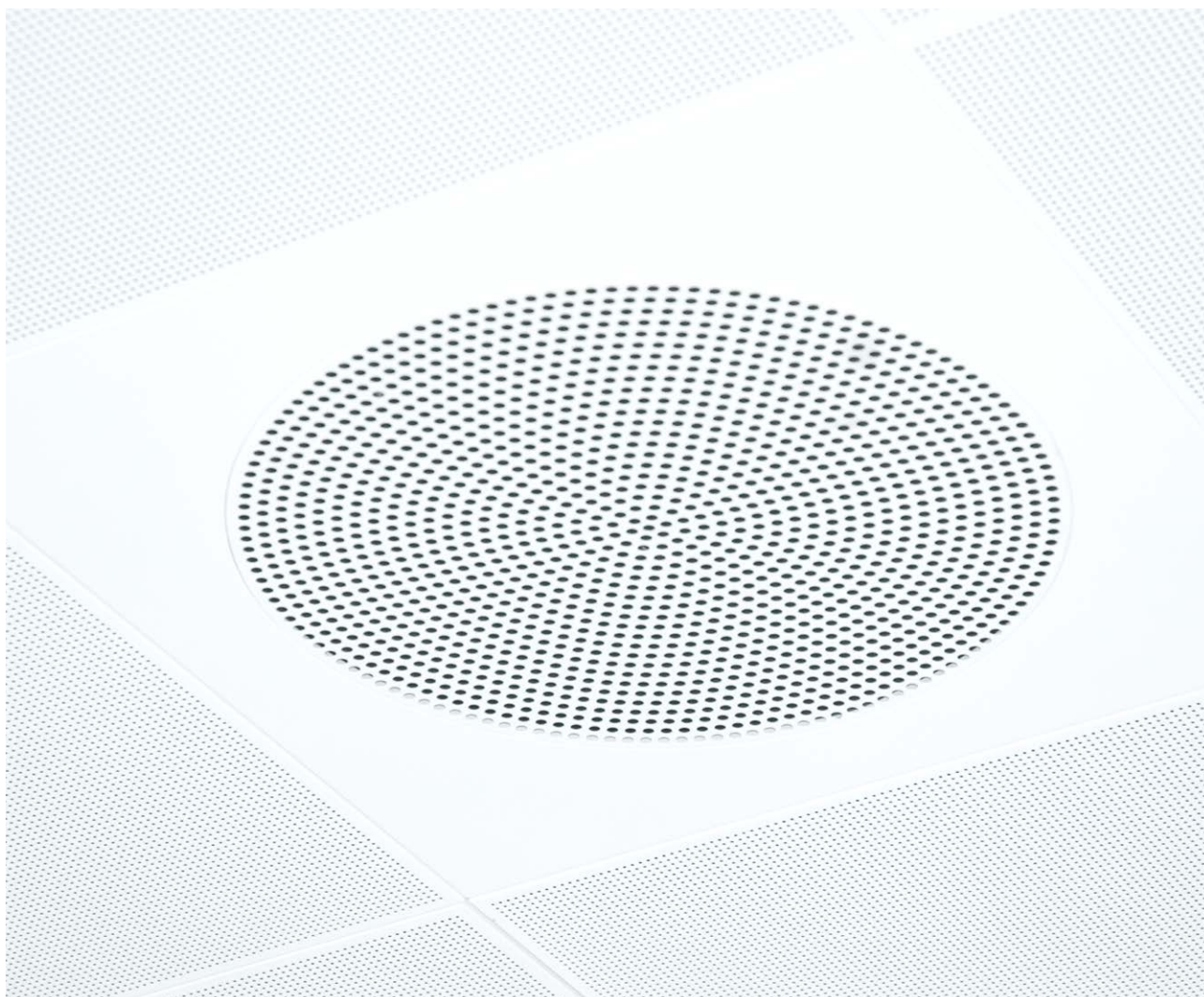

PC7, Integrated in Luxalon Clip-In ceiling with adapted module plate, type LM.

Lindab Integra

Integra is a series of flush mounted ceiling diffusers for mixed ventilation. The diffusers are primarily offered in circular, but are also available in square forms with a large selection of face plates in different designs, which satisfy requirements as well as function. The circular diffusers are normally cut directly into the ceiling when mounted, but can by using module plates be adapted for the most common 600x600 ceiling systems. The square diffusers in this series are adapted to the system-ceiling. The diffusers can be mounted in a plenum box type MBB with great advantage, in order to obtain a stable air flow to the diffuser and the possibility for individual adjustments.

Functionality

Integra has a unique magnetic mounting system of the face plates on all circular diffusers with exception of RCG. This ensures an incredibly easy access to all the internal components, which can be detached without the use of tools, and gives free access to the air duct system for cleaning.



PC6, ceiling diffusers

Lindab Integra a series of flush diffusers

Design

See [Comfort and design](#)



Ventilation principle
Supply/exhaust

Size

Accessories

See [product pages](#)

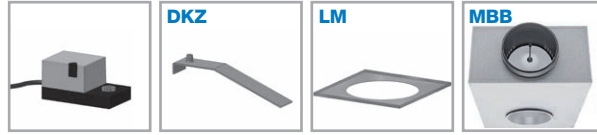

Product

	Perforated	Perforated swirl	Swirl	Swirl	Nozzle	Swirl	Plain	Plain
PC6	 125 160 200 250 315	 160 200 250 315	 160 200 250 315	 160 200 250 315	 125 160 200 250 315	 125 160 200 250 315 400	 125 160 200 250 315	 125 160 200 250 315
	El. - motor	Bracket	Module pl.	MBB box	El. - motor	Bracket	Module pl.	MBB box

Lindab Integra a series of flush diffusers

Ceiling tile adaption

Details, see [Chapter Ceiling tile adaption](#)

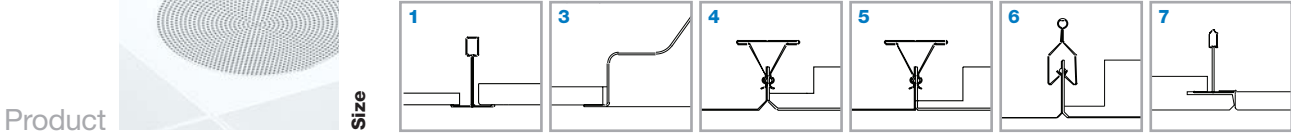

Product

Size

Ceiling types

Danotile T24/T15 Ecophon T24 Rockfon A24.	Plasterboard ceiling	Dampa Clip-In bevelled edge	Dampa Clip-In square edge	Luxalon SQ Clip-In	Danotile Contur Ecophon D Rockfon D-XL
---	----------------------	-----------------------------	---------------------------	--------------------	--

Perforated

mm

F: 595 mm	ØA mm	F: 600 mm	F: 600 mm	F: 600 mm	F: 599 mm
-----------	-------	-----------	-----------	-----------	-----------

PC6		125 160 200 250 315	●	Standard	●	●	●	●	●
			●		●				
			●		●				
			●		●				
			●		●				

Perforated swirl

mm

F: 595 mm	ØA mm	F: 600 mm	F: 600 mm	F: 600 mm	F: 599 mm
-----------	-------	-----------	-----------	-----------	-----------

PC7		160 200 250 315	●	Standard	●	●	●	●	●
			●		●				
			●		●				
			●		●				
			●		●				

Swirl

mm

F: 595 mm	ØA mm	F: 600 mm	F: 600 mm	F: 600 mm	F: 599 mm
-----------	-------	-----------	-----------	-----------	-----------

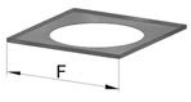
RC14		160 200 250 315	●	Standard	●	●	●	●	●
			●		●				
			●		●				
			●		●				
			●		●				

Swirl

mm

F: 595 mm	ØA mm	F: 600 mm	F: 600 mm	F: 600 mm	F: 599 mm
-----------	-------	-----------	-----------	-----------	-----------

RC15		160 200 250 315	●	Standard	●	●	●	●	●
			●		●				
			●		●				
			●		●				
			●		●				

Nozzles

mm

F: 595 mm	ØA mm	F: 600 mm	F: 600 mm	F: 600 mm	F: 599 mm
-----------	-------	-----------	-----------	-----------	-----------

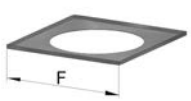
NC19		125 160 200 250 315	●	Standard	●	●	●	●	●
			●		●				
			●		●				
			●		●				
			●		●				

Swirl

mm

F: 595 mm	ØD mm	F: 600 mm	F: 600 mm	F: 600 mm	F: 599 mm
-----------	-------	-----------	-----------	-----------	-----------

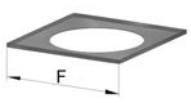
RCG		125 160 200 250 315 400	●	Standard	●	●	●	●	●
			●		●				
			●		●				
			●		●				
			●		●				

Plain

mm

F: 595 mm	595 x 595 mm	F: 600 mm	F: 600 mm	F: 600 mm	F: 599 mm
-----------	--------------	-----------	-----------	-----------	-----------

LCP	No separate module plate (Integrated in design)	125 160 200 250 315	Standard*	●	●	●	●	●
			Standard*	●	●	●	●	
			Standard*	●	●	●	●	
			Standard*	●	●	●	●	
			Standard*	●	●	●	●	

Plain

mm

F: 595 mm	595 x 595 mm	F: 600 mm	F: 600 mm	F: 600 mm	F: 599 mm
-----------	--------------	-----------	-----------	-----------	-----------

LKP	No separate module plate (Integrated in design)	125 160 200 250 315	Standard*	●	●	●	●
			Standard*	●	●	●	●
			Standard*	●	●	●	●
			Standard*	●	●	●	●
			Standard*	●	●	●	●

* In other ceiling systems the grille box is adapted to the ceiling

Lindab Integra

a series of flush diffusers

Product	Size	Ceiling types					
		8	9	10	11	14	
		Ecophon Focus DG	Rockfon E10 24 Ecophon - E / T24	Rockfon E10 15 Ecophon - E / T15	Danotile Markant	Ecophon Focus edge DS	
		F: 592 mm	F: 575 mm	F: 584 mm	F: 575 mm	F: 599 mm	
PC6	125 160 200 250 315						
	Perforated	F: 592 mm	F: 575 mm	F: 584 mm	F: 575 mm	F: 599 mm	
PC7	160 200 250 315						
	Perforated swirl	F: 592 mm	F: 575 mm	F: 584 mm	F: 575 mm	F: 599 mm	
RC14	160 200 250 315						
	Swirl	F: 592 mm	F: 575 mm	F: 584 mm	F: 575 mm	F: 599 mm	
RC15	160 200 250 315						
	Swirl	F: 592 mm	F: 575 mm	F: 584 mm	F: 575 mm	F: 599 mm	
NC19	125 160 200 250 315						
	Nozzles	F: 592 mm	F: 575 mm	F: 584 mm	F: 575 mm	F: 599 mm	
RCG	125 160 200 250 315 400						
	Swirl	F: 592 mm	F: 575 mm	F: 584 mm	F: 575 mm	F: 599 mm	
LCP	125 160 200 250 315	No separate module plate (Integrated in design)					
	Plain	F: 592 mm	F: 575 mm	F: 584 mm	F: 575 mm	F: 599 mm	
LKP	125 160 200 250 315	No separate module plate (Integrated in design)					
	Plain	F: 592 mm	F: 575 mm	F: 584 mm	F: 575 mm	F: 599 mm	

- 1
- 2
- 3
- 4
- 5
- 6
- 7
- 8
- 9
- 10
- 11
- 12
- 13
- 14
- 15
- 16
- 17
- 18

Perforated diffuser

PC6



Description

PC6 is a circular perforated diffuser that can be used for both supply air and exhaust. The diffuser is suitable for the horizontal supply of cooled air. The diffuser can also be used for low impulse and is therefore useful for the supply of replacement air in environments with high rates of air exchange. Installing this diffuser in a plenum box type MBB can help to achieve a stable flow of air to the diffuser as well as realise the potential for individual adjustment.

- Suitable for both supply and exhaust air
- Discrete design
- Can be used for low impulse supply air

Maintenance

The face plate can be removed to enable cleaning of internal parts or to gain access to the duct or box. The visible parts of the diffuser can be wiped with a damp cloth.

Order code

Product	PC6	a	bbb
Type	PC6		
Functional use			
S = Supply air			
E = Exhaust			
L = Low-impulse			
Connection dim.			
Ød 125-315			

Example: PC6-S-200

Dimensions

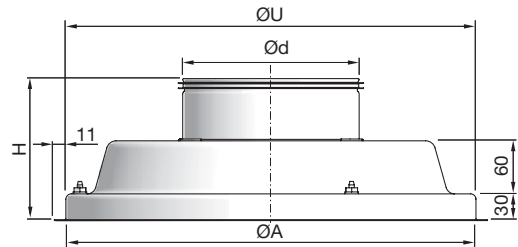

PC6 Ød	ØA	H	ØU*	Weight
mm	mm	mm	mm	kg
125	360	140	370	3.90
160	460	140	470	5.30
200	460	140	470	5.40
250	540	140	550	7.40
315	540	140	550	8.10

* ØU = ceiling grid opening

Ød 315, No mounting holes for MBB !

PC6-S



Materials and finish

Material: Galvanised steel
 Standard finish: Powder-coated
 Standard colour: RAL 9010 Gloss 30

The diffuser is available in other colours. Please contact Lindab's sales department for further information.

Perforated diffuser

PC6

Accessories

Mounting brackets

DCZ

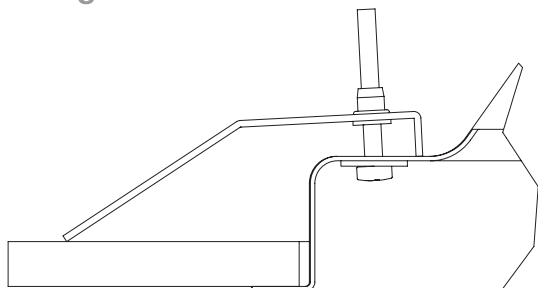

Plenum box

MBB



Extension piece

MBZ

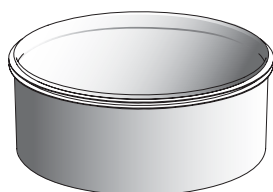

PC6 + MBB

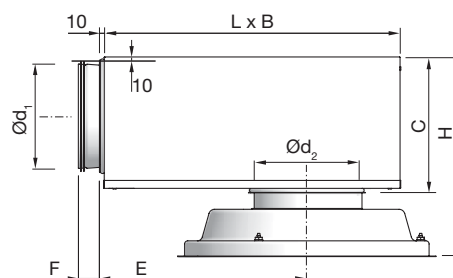

Order code - accessories

Product	aaa	bbb
Type		
Size		

Example: MBZ-200

PC6 + MBB		B	C	E	F	H*	L
duct	PC6	mm	mm	mm	mm	mm	mm
Ød ₁ mm	Ød ₂ mm						
100	125	260	159	216	50	250 - 290	310
100	160	260	159	216	50	250 - 290	310
125	125	310	184	262	50	275 - 315	376
125	160	310	184	262	50	275 - 315	376
125	200	310	184	262	50	275 - 315	376
160	160	380	220	323	50	309 - 349	459
160	200	380	220	323	50	309 - 349	459
160	250	380	220	323	50	309 - 349	459
200	200	460	259	396	70	350 - 390	565
200	250	460	259	396	70	350 - 390	565
200	315	460	259	396	70	350 - 390	565
250	250	540	309	486	70	400 - 440	698
250	315	540	309	486	70	400 - 440	698
315	315	540	373	646	70	465 - 505	858

* Using accessory MBZ the H dimension will increase:

Ød₂ = 125 - 200 mm => H +40 mm

Ød₂ = 250 - 315 mm => H +60 mm

Module plate

LM



Order code - module plate

Product	LM	a	PC6	ccc
Type				
Ceiling system				
Diffuser				
Size				

Example: LM-1-PC6-200

Ceiling system - see introductory summary

Order code

Product	MBB	aaa	bbb	c
Type				
MBB				
Duct connection Ød₁				
Ø100-315				
Diffuser dimension Ød₂				
Ø125-315				
Functional use				
S = Supply air				
E = Exhaust				

Example: PC6-S-200-MBB-160-200-S

Perforated diffuser

PC6

Technical data

Capacity

Air flow q_v [l/s] and [m³/h], total pressure Δp_t [Pa], throw $l_{0,2}$ [m] and sound power level L_{WA} [dB(A)] can be seen in the diagrams.

Frequency-related sound effect level

The sound effect level in the frequency band is defined as $L_{WA}+K_{ok}$. K_{ok} values are specified in charts beneath the diagrams on the following pages.

Quick selection, supply air

PC6 + MBB		$\Delta p_t \geq 50$ Pa 30 dB(A)		$\Delta p_t \geq 50$ Pa 35 dB(A)	
duct $\varnothing d_1$	PC6 $\varnothing d_2$	l/s	m ³ /h	l/s	m ³ /h
100	125	32	115	38	137
100	160	39	140	46	166
125	125	39	140	46	166
125	160	48	173	62	223
125	200	56	202	66	238
160	160	53	191	62	223
160	200	66	238	78	281
160	250	74	266	95	342
200	200	71	256	85	306
200	250	92	331	112	403
200	315	113	407	138	497
250	250	110	396	130	468
250	315	122	439	152	547
315	315	156	562	188	677

Low-impulse

Correction sound power level (L_{WA}) and pressure loss (Δp_t)

On the following pages you can find diagrams for all sizes PC6+MBB supply air. When low-impulse values are wanted use the correction factors in the table below.

PC6-L + MBB		Low-impulse Correction factor	
duct $\varnothing d_1$	PC6-L $\varnothing d_2$	L_{WA}	Δp_t
100	125	-1	x 1
100	160	1	x 1
125	125	-4	x 1
125	160	-1	x 1
125	200	-2	x 1
160	160	-5	x 0,9
160	200	-3	x 1
160	250	-2	x 1
200	200	0	x 1
200	250	0	x 1
200	315	-1	x 1
250	250	-5	x 0,9
250	315	-2	x 1
315	315	0	x 1

Throw $l_{0,2}$

Throw $l_{0,2}$ [m] is specified at a terminal velocity of 0.2 m/s.

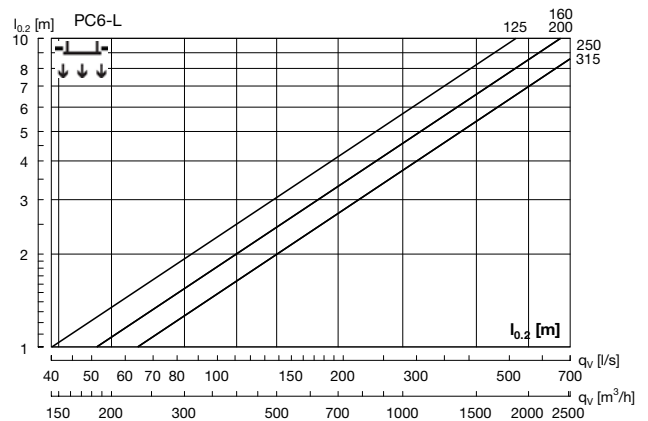
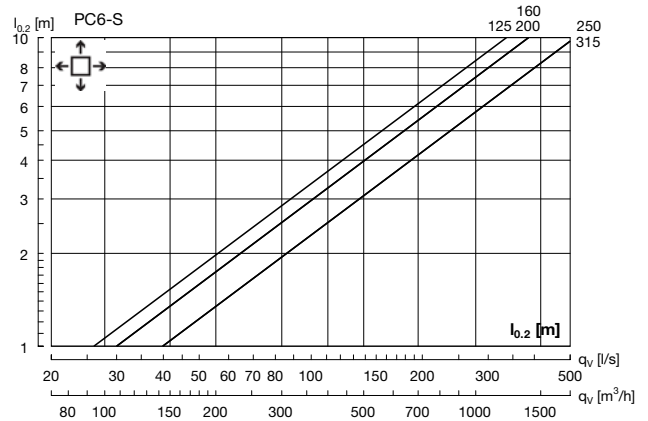

Sound attenuation

Sound attenuation of the diffusers ΔL from duct to room, including end reflection, see table below.

PC6 + MBB		Centre frequency Hz							
duct $\varnothing d_1$	PC6 $\varnothing d_2$	63	125	250	500	1K	2K	4K	8K
100	125	19	16	7	15	19	18	19	21
100	160	17	15	4	14	17	17	17	18
125	125	17	15	9	19	17	19	18	20
125	160	15	14	8	18	15	16	17	19
125	200	13	11	4	14	13	15	16	17
160	160	15	15	10	21	17	18	19	20
160	200	18	15	8	21	17	17	18	19
160	250	16	14	5	17	13	15	17	18
200	200	13	11	8	16	18	16	19	17
200	250	13	9	5	14	16	15	18	16
200	315	13	8	3	10	16	14	16	16
250	250	14	8	7	15	17	17	18	17
250	315	13	7	6	14	16	15	16	17
315	315	8	9	8	14	17	16	17	21

Balancing

Balancing data is contained in a separate brochure.

Perforated diffuser

PC6

Technical data

PC6 without box - Supply air

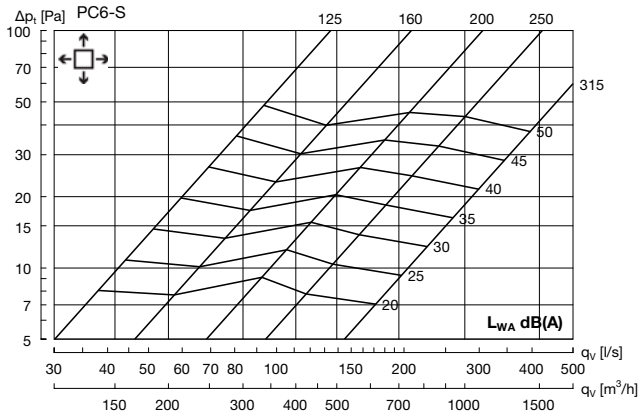

PC6 125 + MBB - Supply air

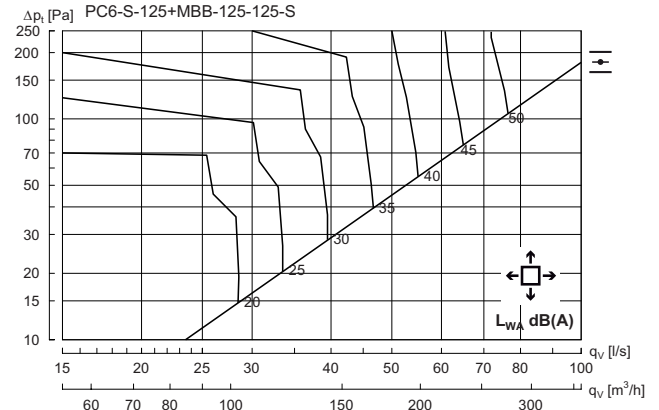

Hz	63	125	250	500	1K	2K	4K	8K
K_{ok}	7	2	-4	0	-4	-14	-23	-32

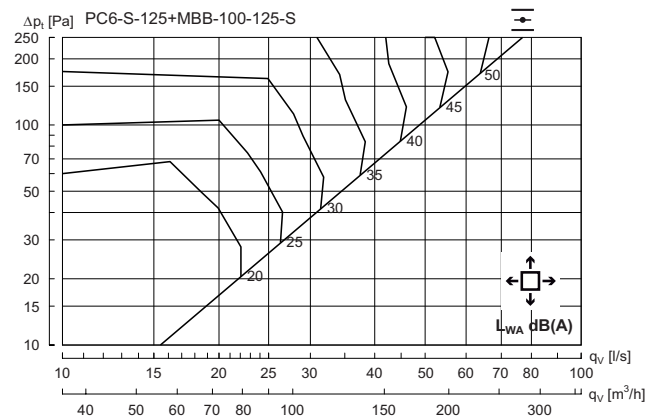

Hz	63	125	250	500	1K	2K	4K	8K
K_{ok}	10	6	1	-2	-5	-12	-18	-25

Perforated diffuser

PC6

Technical data

PC6 160 + MBB - Supply air

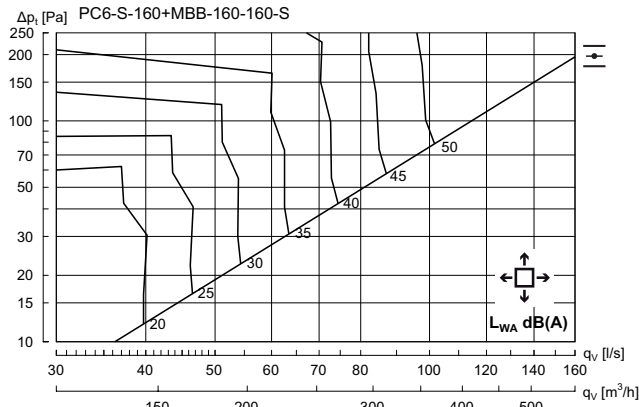

Hz	63	125	250	500	1K	2K	4K	8K
K_{ok}	10	3	-5	-1	-3	-15	-23	-29

PC6 200 + MBB - Supply air

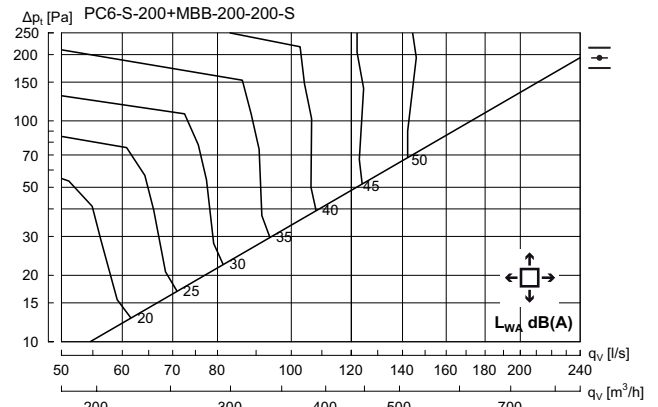

Hz	63	125	250	500	1K	2K	4K	8K
K_{ok}	11	2	-5	-1	-4	-15	-22	-27

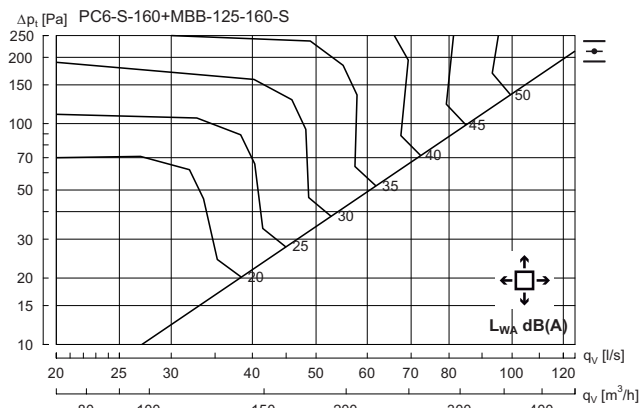

Hz	63	125	250	500	1K	2K	4K	8K
K_{ok}	9	5	0	-2	-5	-12	-17	-25

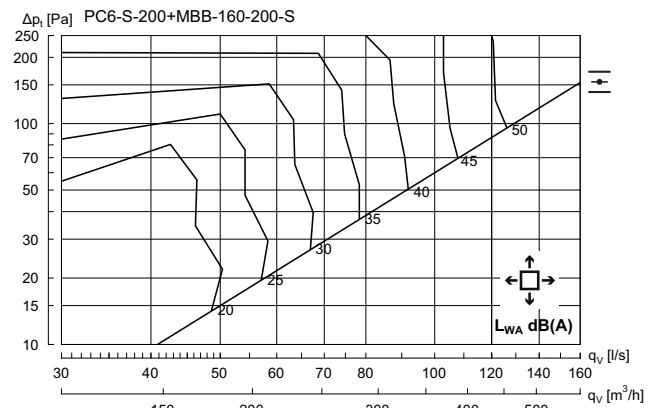

Hz	63	125	250	500	1K	2K	4K	8K
K_{ok}	11	4	-2	-2	-3	-12	-20	-27

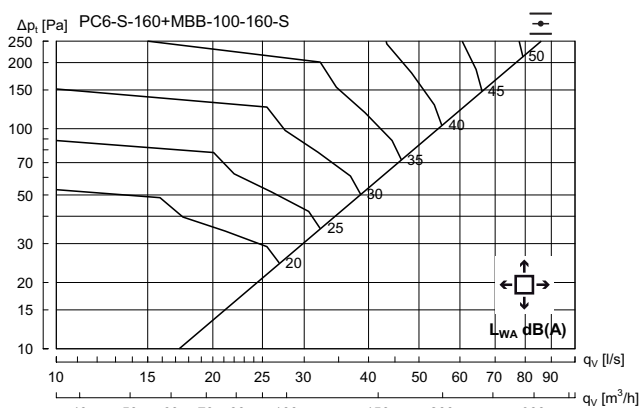

Hz	63	125	250	500	1K	2K	4K	8K
K_{ok}	7	4	0	-1	-5	-11	-16	-22

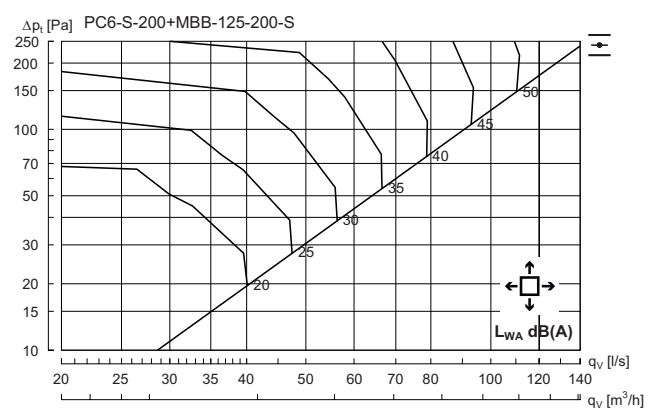

Hz	63	125	250	500	1K	2K	4K	8K
K_{ok}	6	5	0	-2	-5	-10	-16	-22

Perforated diffuser

PC6

Technical data

PC6 250 + MBB - Supply air

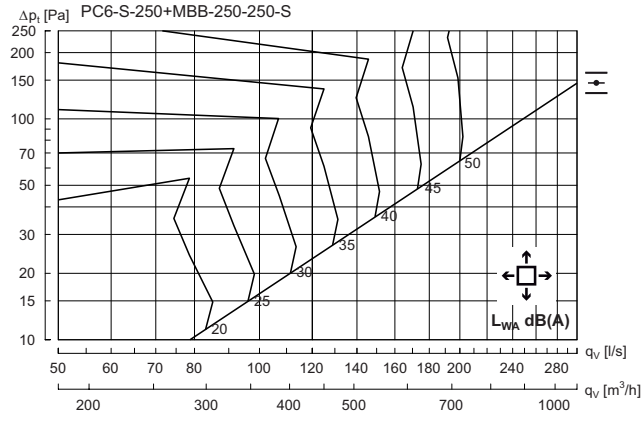

Hz	63	125	250	500	1K	2K	4K	8K
K_{ok}	9	-1	-6	0	-4	-16	-25	-30

PC6 315 + MBB - Supply air

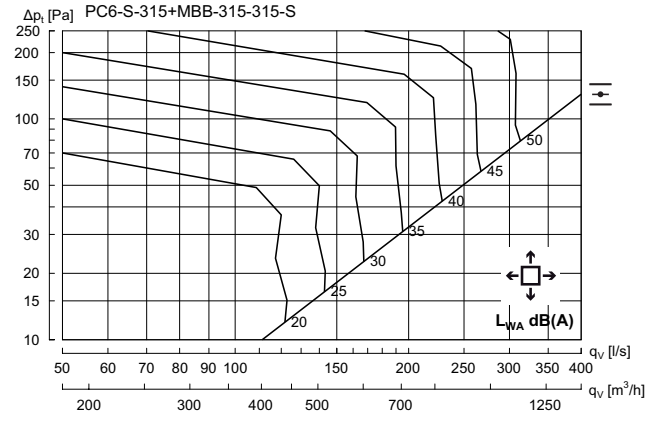

Hz	63	125	250	500	1K	2K	4K	8K
K_{ok}	13	1	-2	-2	-4	-13	-23	-29

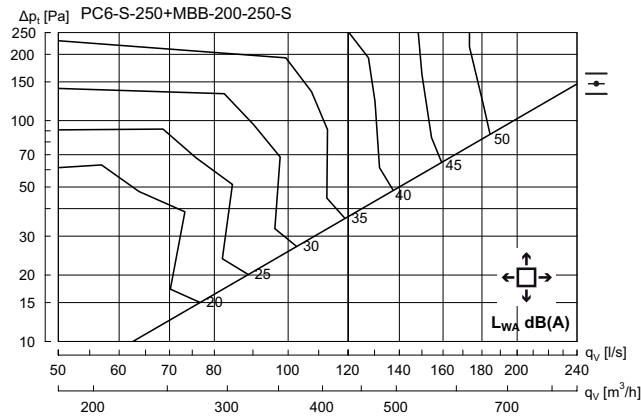

Hz	63	125	250	500	1K	2K	4K	8K
K_{ok}	11	3	-3	-2	-3	-14	-22	-29

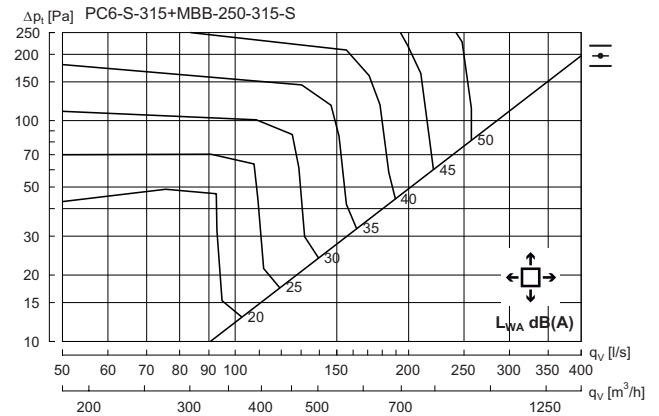

Hz	63	125	250	500	1K	2K	4K	8K
K_{ok}	11	2	-3	-2	-3	-13	-19	-26

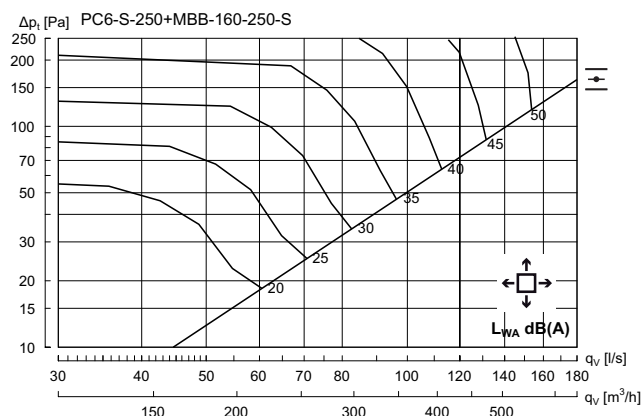

Hz	63	125	250	500	1K	2K	4K	8K
K_{ok}	12	3	-1	-4	-4	-10	-18	-24

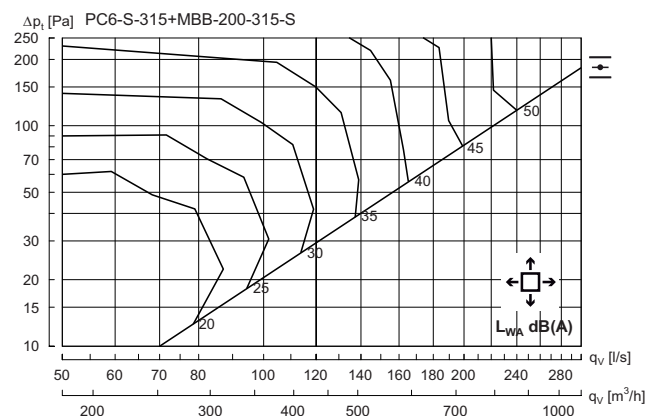

Hz	63	125	250	500	1K	2K	4K	8K
K_{ok}	10	6	-1	-2	-4	-12	-20	-26

Perforated diffuser

PC6

Technical data

PC6 without box - Exhaust air

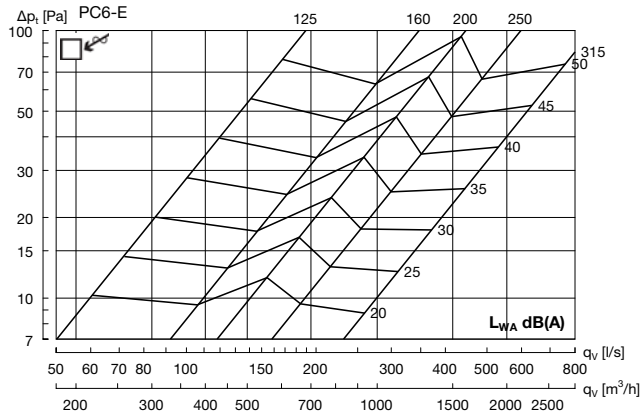

PC6 125 + MBB - Exhaust air

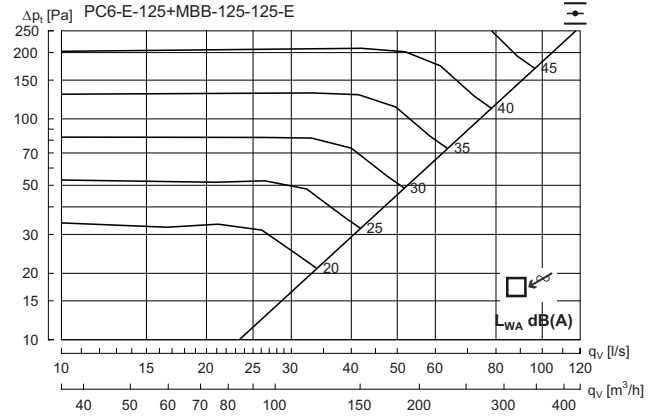

Hz	63	125	250	500	1K	2K	4K	8K
K_{ok}	12	5	0	-2	-5	-11	-14	-21

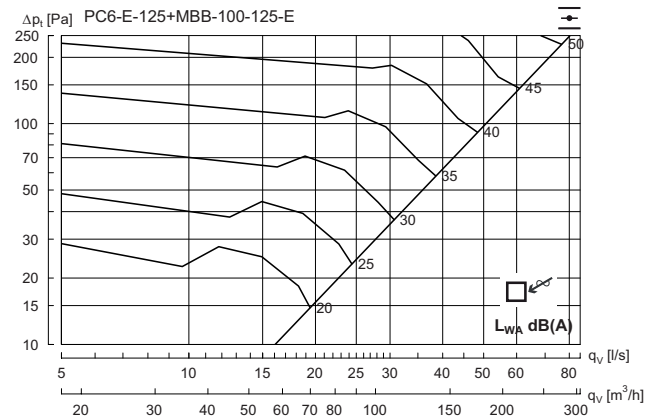

Hz	63	125	250	500	1K	2K	4K	8K
K_{ok}	11	-1	4	-2	-8	-11	-16	-23

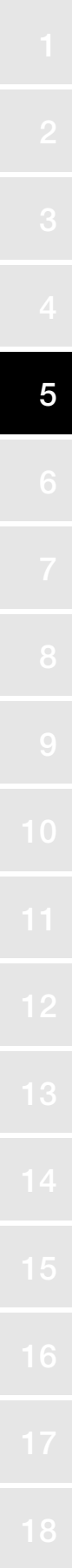

Perforated diffuser

PC6

Technical data

PC6 160 + MBB - Exhaust air

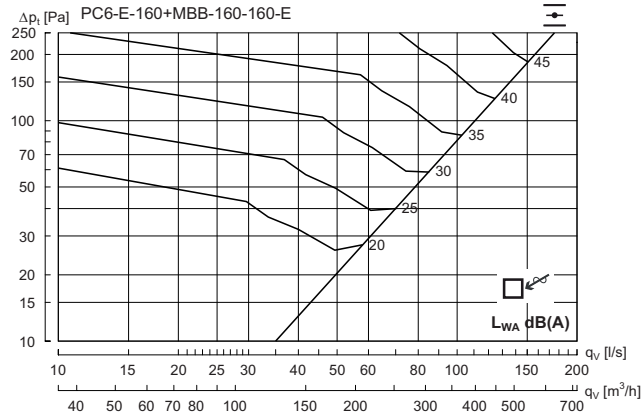

Hz	63	125	250	500	1K	2K	4K	8K
K_{ok}	20	8	-1	-4	-6	-12	-18	-21

PC6 200+ MBB - Exhaust air

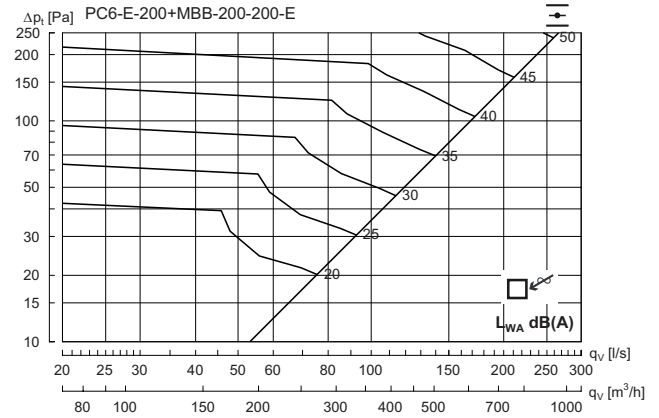

Hz	63	125	250	500	1K	2K	4K	8K
K_{ok}	14	4	0	-3	-5	-9	-15	-23

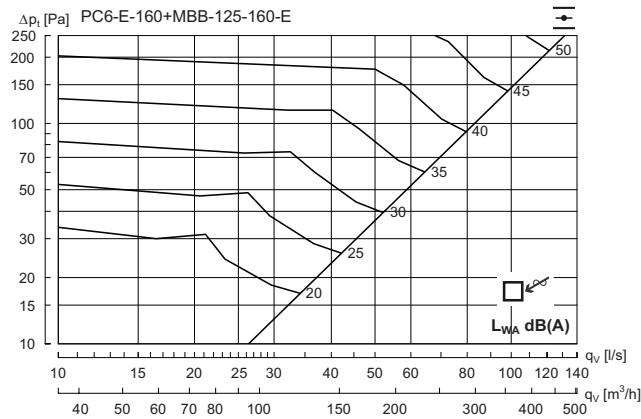

Hz	63	125	250	500	1K	2K	4K	8K
K_{ok}	12	6	1	-2	-6	-11	-14	-21

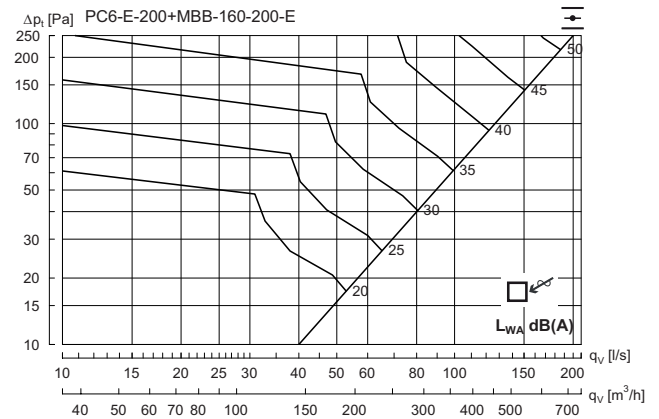

Hz	63	125	250	500	1K	2K	4K	8K
K_{ok}	15	6	-1	-3	-5	-9	-15	-21

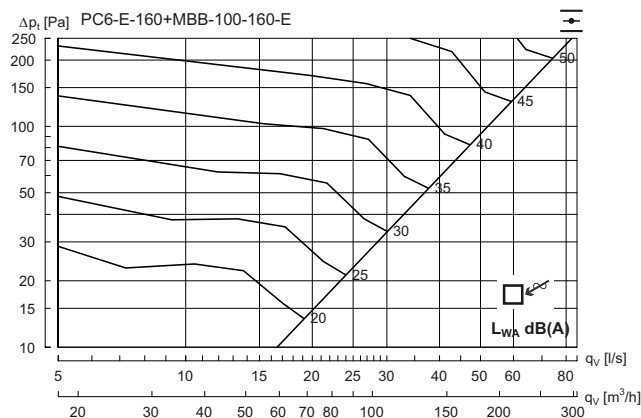

Hz	63	125	250	500	1K	2K	4K	8K
K_{ok}	9	3	3	-1	-8	-11	-16	-22

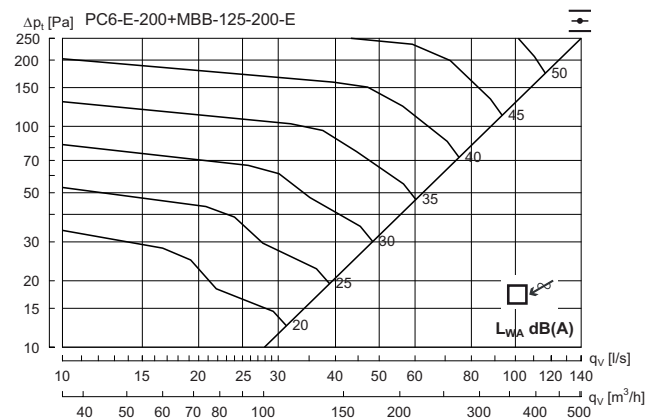

Hz	63	125	250	500	1K	2K	4K	8K
K_{ok}	10	3	1	-2	-5	-10	-16	-22

Perforated diffuser

PC6

Technical data

PC6 250+ MBB - Exhaust air

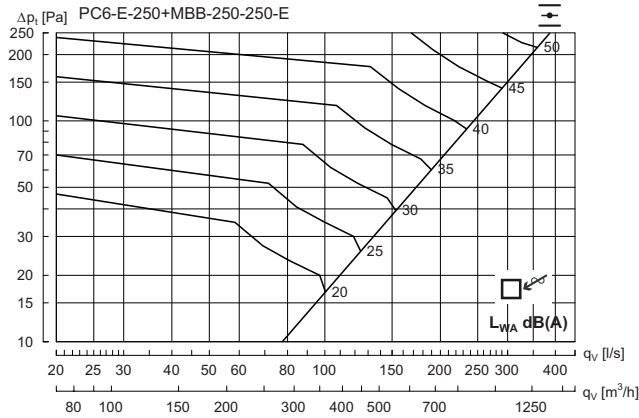

Hz	63	125	250	500	1K	2K	4K	8K
K_{ok}	10	5	2	-3	-5	-11	-17	-24

PC6 315+ MBB - Exhaust air

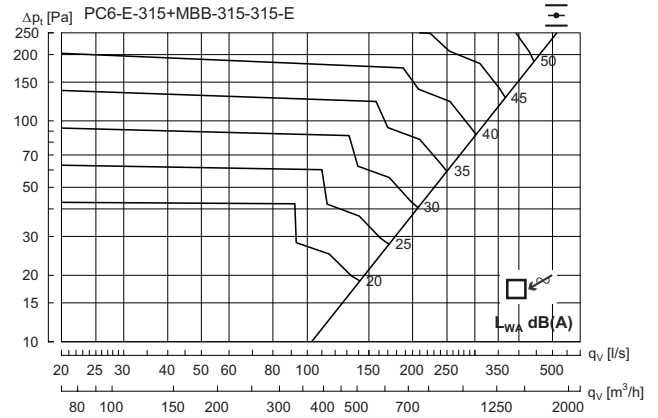

Hz	63	125	250	500	1K	2K	4K	8K
K_{ok}	13	5	3	-3	-6	-10	-16	-27

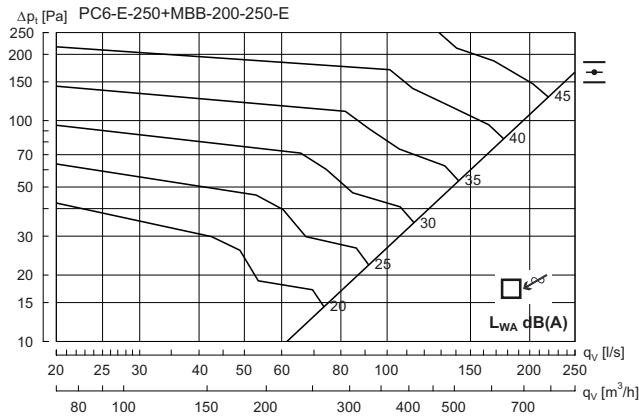

Hz	63	125	250	500	1K	2K	4K	8K
K_{ok}	13	4	0	-3	-5	-10	-14	-21

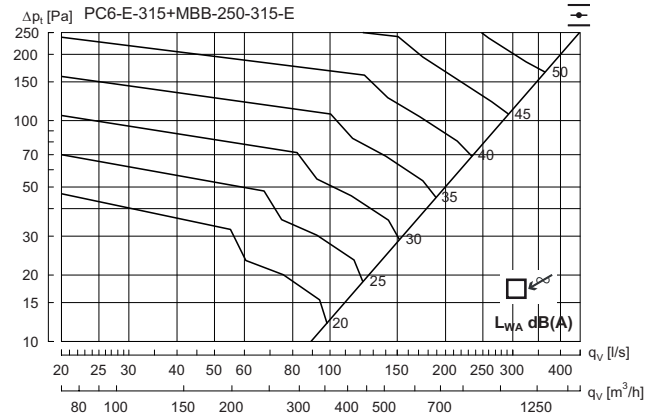

Hz	63	125	250	500	1K	2K	4K	8K
K_{ok}	8	5	2	-3	-5	-11	-17	-25

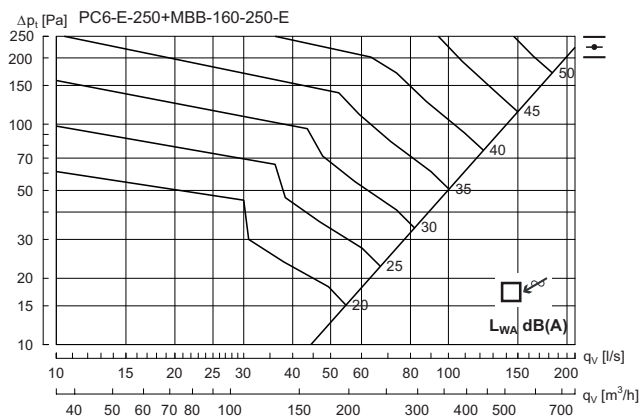

Hz	63	125	250	500	1K	2K	4K	8K
K_{ok}	14	6	0	-4	-6	-9	-14	-19

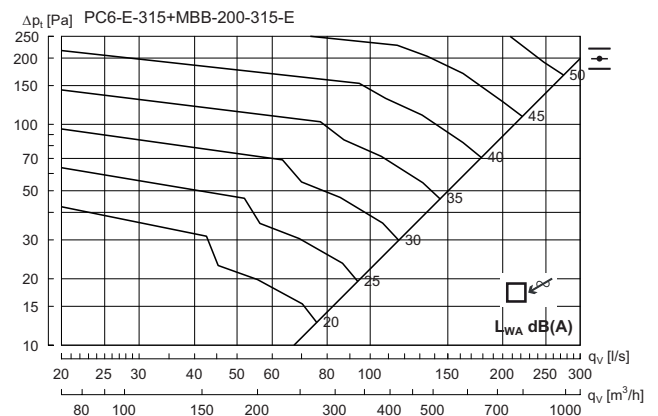

Hz	63	125	250	500	1K	2K	4K	8K
K_{ok}	13	5	1	-3	-5	-9	-14	-22

Perforated diffuser

PC7



Description

PC7 is a circular diffuser with perforated face plate and integrated swirl insert. The diffuser is suitable for the horizontal supply of very cold air. The integrated swirl insert ensures optimum distribution and high induction. Installing this diffuser in a plenum box type MBB can help to achieve a stable flow of air to the diffuser as well as realise the potential for individual adjustment.

- High induction
- Discrete design
- Suitable for cooling at very low temperatures

Maintenance

The face plate and swirl insert can be removed to enable cleaning of internal parts or to gain access to the duct or box. The visible parts of the diffuser can be wiped with a damp cloth.

Order code

Product	PC7	S	aaa
Type	PC7		
Functional use		S = Supply air	
Connection dim.			Ød 160-315

Example: PC7-S-200

Dimensions

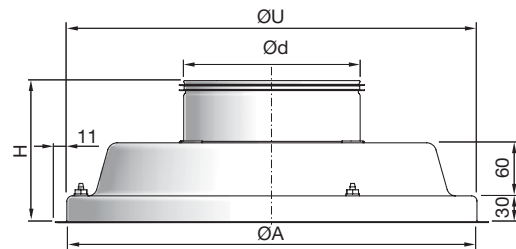

PC7 Ød	ØA	H	ØU*	Weight
mm	mm	mm	mm	kg
160	460	140	470	5.30
200	460	140	470	5.40
250	540	140	550	7.40
315	540	140	550	8.10

* ØU = ceiling grid opening

Ød 315, No mounting holes for MBB !

PC7-S



Materials and finish

Material: Galvanised steel
 Standard finish: Powder-coated
 Standard colour: RAL 9003, 9010 Gloss 30

The diffuser is available in other colours. Please contact Lindab's sales department for further information.

Perforated diffuser

PC7

Accessories

Mounting brackets

DCZ

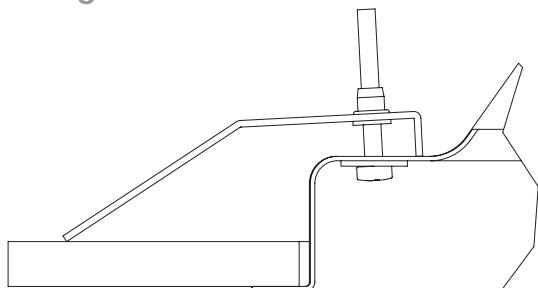

Extension piece

MBZ

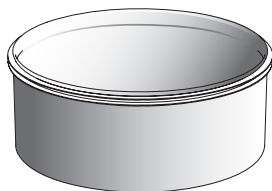

Order code - accessories

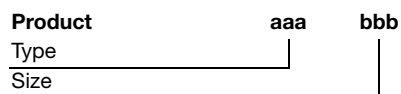

Example: DCZ-200

Module plate

LM



Order code - module plate

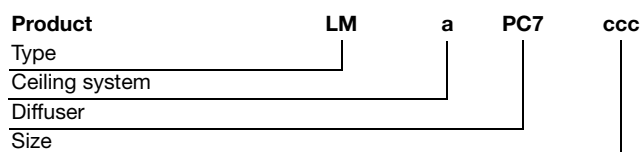

Example: LM-1-PC7-200

Ceiling system - see introductory summary.

Plenum box

MBB



PC7 + MBB

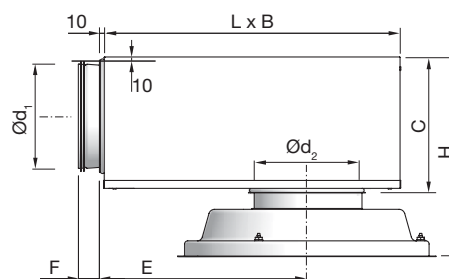

PC7 + MBB		B	C	E	F	H*	L
duct	PC7	mm	mm	mm	mm	mm	mm
Ød ₁ mm	Ød ₂ mm						
100	160	260	159	216	50	250 - 290	310
125	160	310	184	262	50	275 - 315	376
125	200	310	184	262	50	275 - 315	376
160	160	380	220	323	50	309 - 349	459
160	200	380	220	323	50	309 - 349	459
160	250	380	220	323	50	309 - 349	459
200	200	460	259	396	70	350 - 390	565
200	250	460	259	396	70	350 - 390	565
200	315	460	259	396	70	350 - 390	565
250	250	540	309	486	70	400 - 440	698
250	315	540	309	486	70	400 - 440	698
315	315	540	373	646	70	465 - 505	858

* Using accessory MBZ the H dimension will increase:

Ød₂ = 160 - 200 mm => H +40 mm

Ød₂ = 250 - 315 mm => H +60 mm

Order code

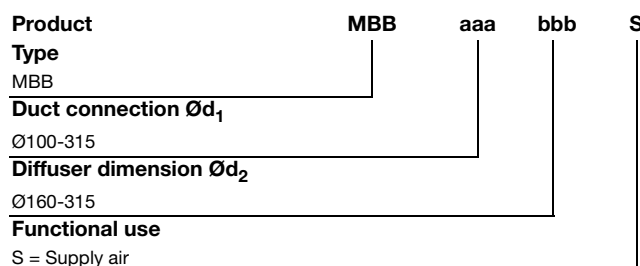

Example: PC7-S-200-MBB-160-200-S

Perforated diffuser

PC7

Technical data

Capacity

Air flow q_v [l/s] and [m³/h], total pressure Δp_t [Pa], throw $l_{0,2}$ [m] and sound power level L_{WA} [dB(A)] can be seen in the diagrams.

Frequency-related sound effect level

The sound effect level in the frequency band is defined as $L_{WA} + K_{ok}$. K_{ok} values are specified in charts beneath the diagrams on the following pages.

Quick selection, supply air

PC7 + MBB		$\Delta p_t \geq 50$ Pa 30 dB(A)		$\Delta p_t \geq 50$ Pa 35 dB(A)	
duct $\varnothing d_1$	PC7 $\varnothing d_2$	l/s	m ³ /h	l/s	m ³ /h
100	160	36	130	43	155
125	160	44	158	55	198
125	200	50	180	60	216
160	160	47	169	55	198
160	200	55	198	66	238
160	250	71	256	88	317
200	200	60	216	72	259
200	250	84	302	99	356
200	315	93	335	113	407
250	250	88	317	103	371
250	315	96	346	114	410
315	315	107	385	127	457

Throw $l_{0,2}$

Throw $l_{0,2}$ [m] is specified at a terminal velocity of 0.2 m/s.

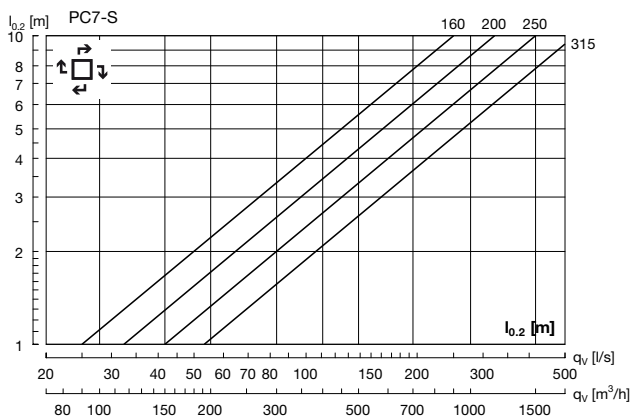

Sound attenuation

Sound attenuation of the diffusers ΔL from duct to room, including end reflection - see table below.

PC7 + MBB		Centre frequency Hz							
duct $\varnothing d_1$	PC7 $\varnothing d_2$	63	125	250	500	1K	2K	4K	8K
100	160	17	15	5	12	18	17	17	19
125	160	15	14	7	18	16	17	18	20
125	200	12	11	4	14	14	16	16	18
160	160	17	15	10	21	18	19	20	20
160	200	18	15	8	21	17	17	19	20
160	250	17	14	4	16	14	16	18	19
200	200	14	10	8	16	19	16	20	18
200	250	12	10	6	14	17	15	18	17
200	315	12	8	4	10	16	14	17	16
250	250	13	9	8	15	17	17	18	18
250	315	13	7	6	14	16	16	17	17
315	315	9	9	9	14	17	16	17	22

Balancing

Balancing data is contained in a separate brochure.

Perforated diffuser

PC7

Technical data

PC7 without box - Supply air

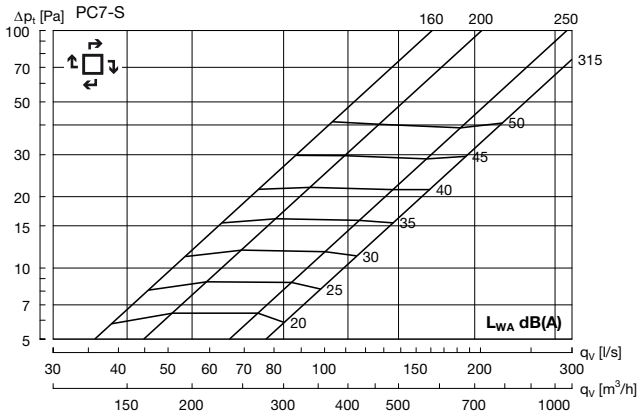

PC7 160 + MBB - Supply air

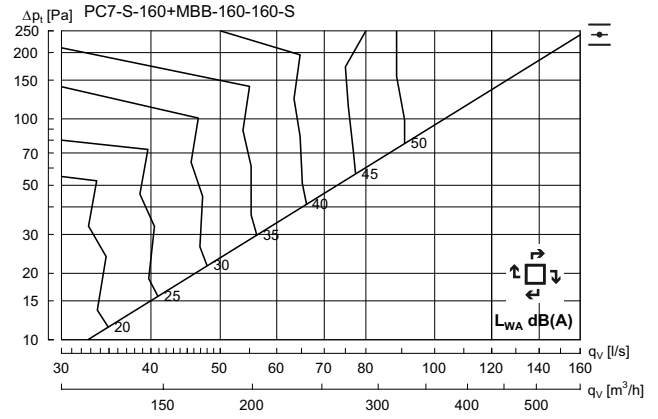

Hz	63	125	250	500	1K	2K	4K	8K
K_{ok}	10	1	-4	-1	-3	-18	-26	-32

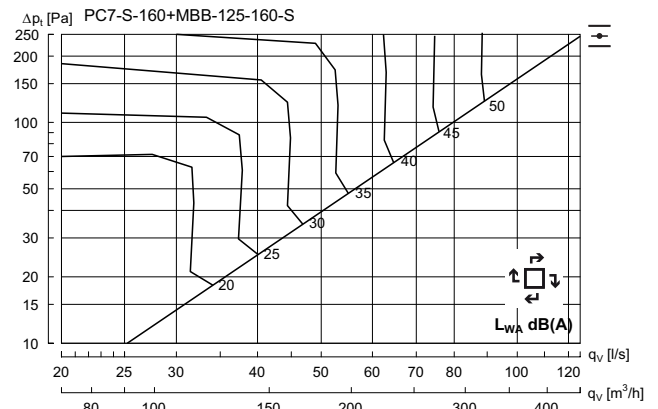

Hz	63	125	250	500	1K	2K	4K	8K
K_{ok}	10	4	-1	-1	-5	-14	-19	-25

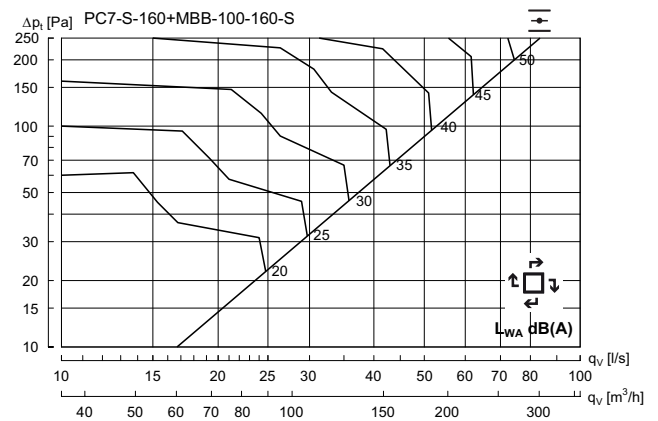

Hz	63	125	250	500	1K	2K	4K	8K
K_{ok}	11	3	0	-1	-6	-10	-14	-20

Perforated diffuser

PC7

Technical data

PC7 200 + MBB - Supply air

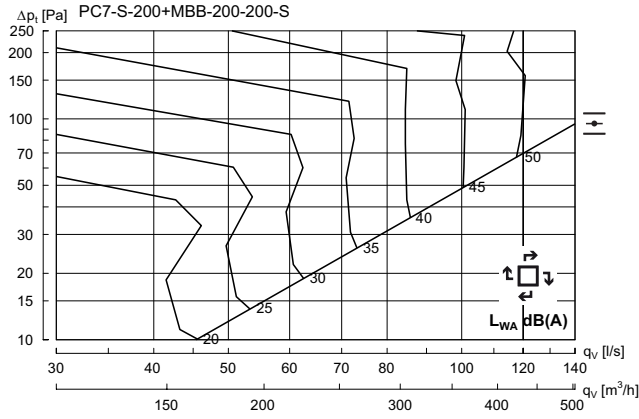

Hz	63	125	250	500	1K	2K	4K	8K
K_{ok}	11	-1	-4	0	-4	-19	-26	-31

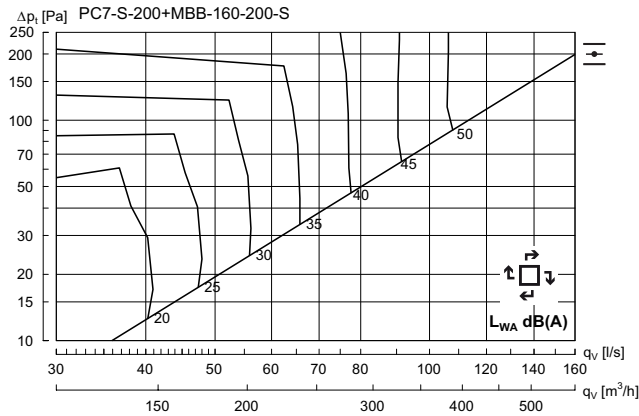

Hz	63	125	250	500	1K	2K	4K	8K
K_{ok}	11	2	-2	-1	-4	-16	-24	-29

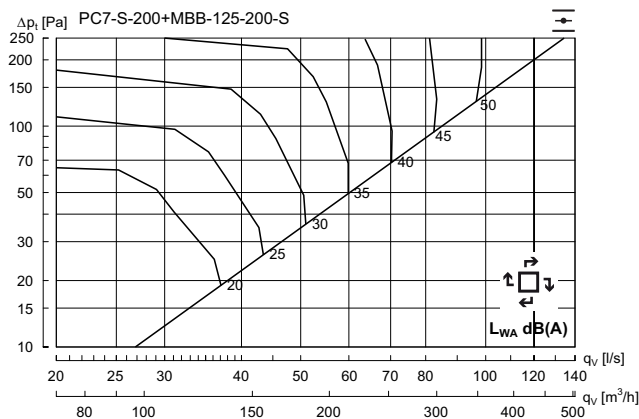

Hz	63	125	250	500	1K	2K	4K	8K
K_{ok}	6	5	1	-1	-5	-13	-19	-24

PC7 250 + MBB - Supply air

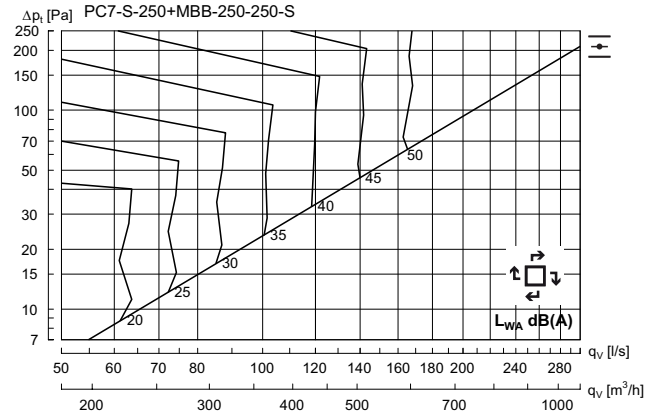

Hz	63	125	250	500	1K	2K	4K	8K
K_{ok}	12	-1	-5	0	-4	-18	-28	-36

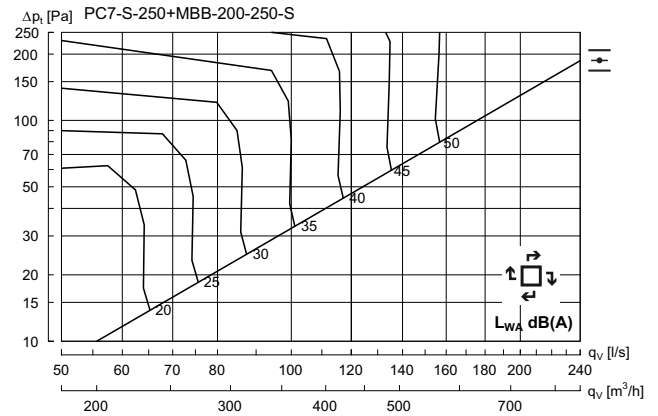

Hz	63	125	250	500	1K	2K	4K	8K
K_{ok}	13	2	-3	-1	-4	-16	-24	-29

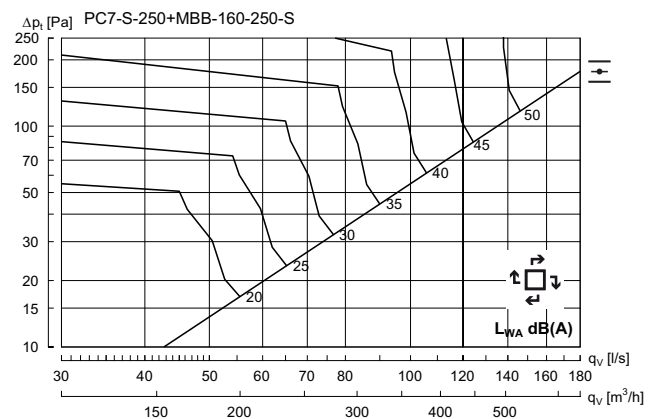

Hz	63	125	250	500	1K	2K	4K	8K
K_{ok}	12	4	1	-2	-4	-13	-20	-26

Perforated diffuser

PC7

Technical data

PC7 315 + MBB - Supply air

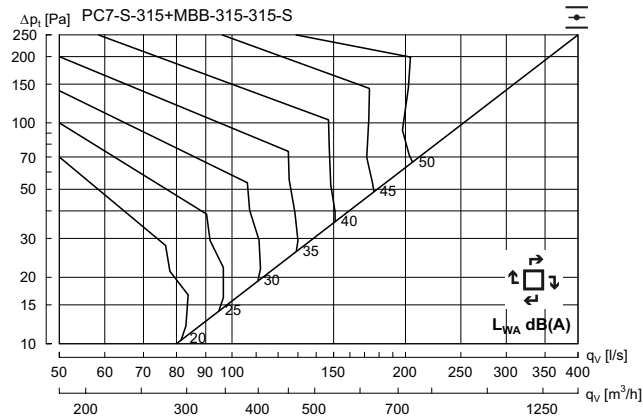

Hz	63	125	250	500	1K	2K	4K	8K
K_{ok}	12	1	-2	0	-5	-18	-23	-32

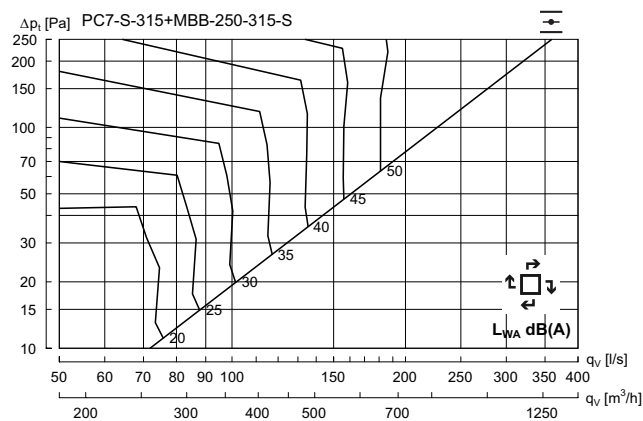

Hz	63	125	250	500	1K	2K	4K	8K
K_{ok}	9	0	-2	0	-4	-16	-25	-34

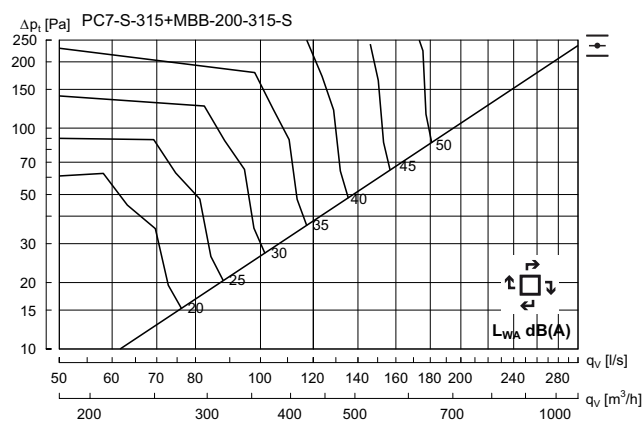

Hz	63	125	250	500	1K	2K	4K	8K
K_{ok}	12	4	-1	-1	-4	-14	-21	-27

Swirl diffuser

RC14



Dimensions

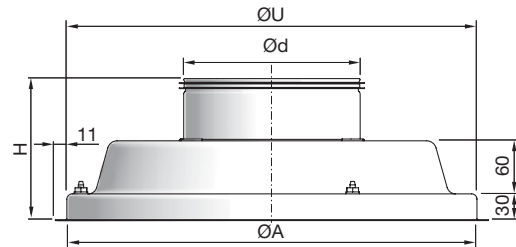

RC14 Ød	ØA	H	ØU*	Weight
mm	mm	mm	mm	kg
160	360	140	370	5.30
200	360	140	370	5.40
250	460	140	470	7.40
315	540	140	550	8.10

* ØU = ceiling grid opening

Ød 315, No mounting holes for MBB !

RC14



Description

RC14 is a circular swirl diffuser with fixed bars. The diffuser can be used for both supply air and exhaust. The swirl pattern ensures high induction and a large dynamic range, and is therefore ideal for the horizontal supply of very cold air. Installing this diffuser in a plenum box type MBB can help to achieve a stable flow of air to the diffuser as well as realise the potential for individual adjustment.

- Large dynamic range
- High induction
- Suitable for cooling at very low temperatures
- Can be used for both supply and exhaust air.

Maintenance

The face plate and swirl insert can be removed to enable cleaning of internal parts or to gain access to the duct or box. The visible parts of the diffuser can be wiped with a damp cloth.

Order code

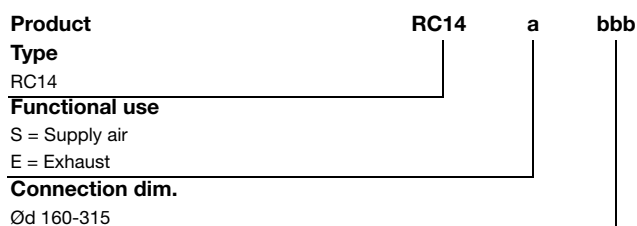

Example: RC14-S-250

Materials and finish

Material: Galvanised steel
 Standard finish: Powder-coated
 Standard colour: RAL 9010 Gloss 30

The diffuser is available in other colours. Please contact Lindab's sales department for further information.

Swirl diffuser

RC14

Accessories

Mounting brackets

DCZ

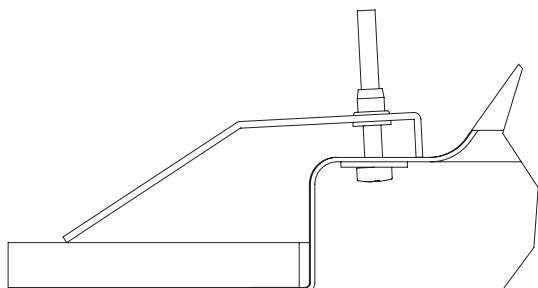

Extension piece

MBZ

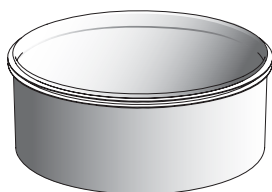

Order code - accessories

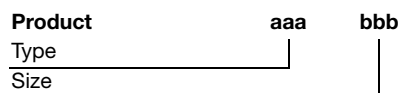

Example: DCZ-250

Module plate

LM



Order code - module plate

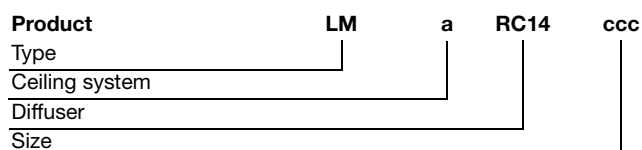

Example: LM-1-RC14-250

Ceiling system - see introductory summary.

Dimensions

Plenum box

MBB



RC14 + MBB

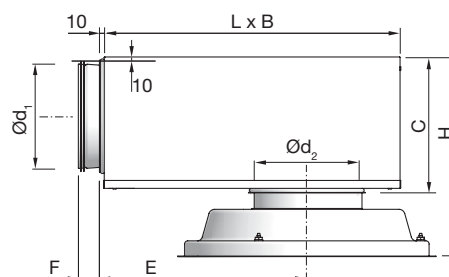

RC14 + MBB		B	C	E	F	H*	L
duct	RC14	mm	mm	mm	mm	mm	mm
Ød ₁ mm	Ød ₂ mm						
100	160	260	159	216	50	250 - 290	310
125	160	310	184	262	50	275 - 315	376
125	200	310	184	262	50	275 - 315	376
160	160	380	220	323	50	309 - 349	459
160	200	380	220	323	50	309 - 349	459
160	250	380	220	323	50	309 - 349	459
200	200	460	259	396	70	350 - 390	565
200	250	460	259	396	70	350 - 390	565
200	315	460	259	396	70	350 - 390	565
250	250	540	309	486	70	400 - 440	698
250	315	540	309	486	70	400 - 440	698
315	315	540	373	646	70	465 - 505	858

* Using accessory MBZ the H dimension will increase:

Ød₂ = 160 - 200 mm => H +40 mm

Ød₂ = 250 - 315 mm => H +60 mm

Order code

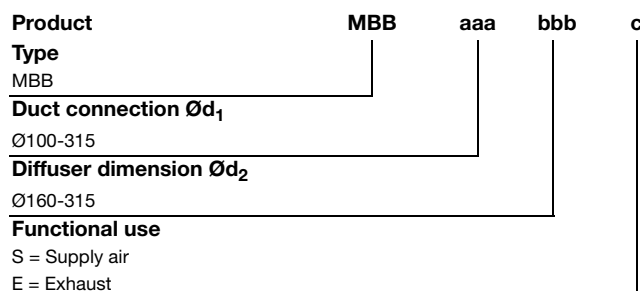

Example: RC14-S-250-MBB-200-250-S

Swirl diffuser

RC14

Technical data

Capacity

Air flow q_v [l/s] and [m³/h], total pressure Δp_t [Pa], throw $l_{0.2}$ [m] and sound power level L_{WA} [dB(A)] can be seen in the diagrams.

Frequency-related sound effect level

The sound effect level in the frequency band is defined as $L_{WA}+K_{ok}$. K_{ok} values are specified in charts beneath the diagrams on the following pages.

Quick selection, supply air

RC14 + MBB		$\Delta p_t \geq 50$ Pa		$\Delta p_t \geq 50$ Pa	
duct	RC14	30 dB(A)		35 dB(A)	
$\varnothing d_1$	$\varnothing d_2$	l/s	m ³ /h	l/s	m ³ /h
100	160	37	133	44	158
125	160	44	158	54	194
125	200	50	180	62	223
160	160	48	173	57	205
160	200	56	202	67	241
160	250	67	241	84	302
200	200	62	223	74	266
200	250	82	295	96	346
200	315	102	367	126	454
250	250	92	331	106	382
250	315	117	421	139	500
315	315	141	508	166	598

Throw $l_{0.2}$

Throw $l_{0.2}$ [m] is specified at a terminal velocity of 0.2 m/s.

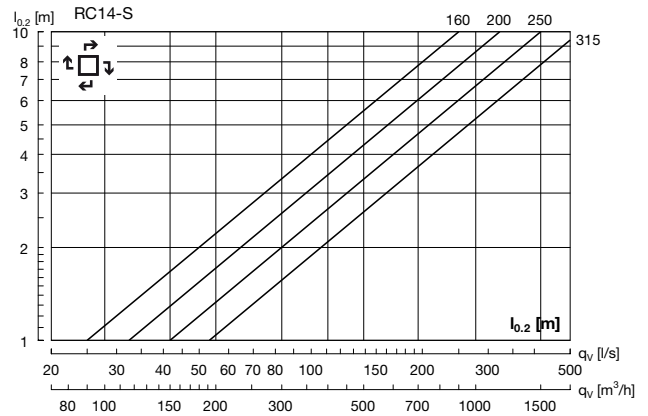

Sound attenuation

Sound attenuation of the diffusers ΔL from duct to room, including end reflection - see table below.

RC14 + MBB		Centre frequency Hz							
duct	RC14	63	125	250	500	1K	2K	4K	8K
$\varnothing d_1$	$\varnothing d_2$								
100	160	18	15	5	11	18	19	18	19
125	160	15	13	8	17	17	17	18	20
125	200	13	11	6	13	14	17	17	19
160	160	16	15	11	21	18	20	21	20
160	200	17	15	9	21	18	19	20	20
160	250	17	14	4	18	14	16	18	19
200	200	14	11	8	15	19	17	20	18
200	250	14	10	5	14	18	14	18	17
200	315	14	8	3	10	16	15	17	16
250	250	14	9	7	15	18	17	19	18
250	315	12	7	6	14	16	15	17	17
315	315	8	9	9	13	17	16	18	22

Balancing

Balancing data is contained in a separate brochure.

Swirl diffuser

RC14

Technical data

RC14 without box – supply air

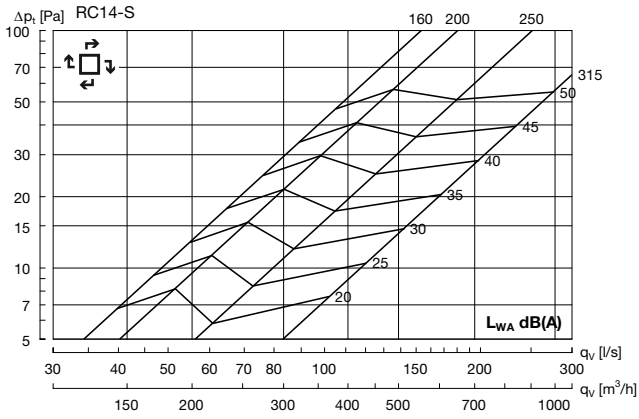

RC14 - 160 + MBB - Supply air

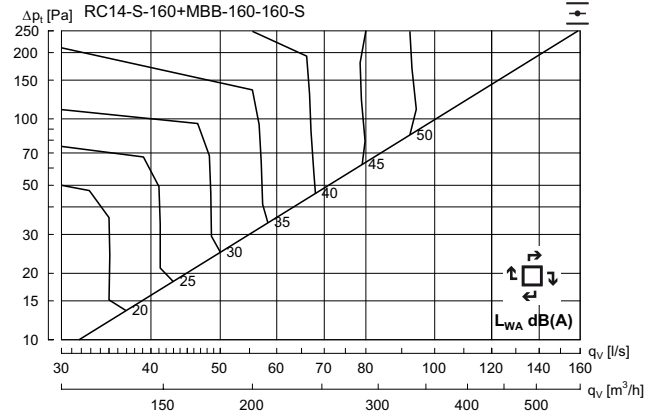

Hz	63	125	250	500	1K	2K	4K	8K
K_{ok}	6	2	-3	0	-4	-15	-26	-32

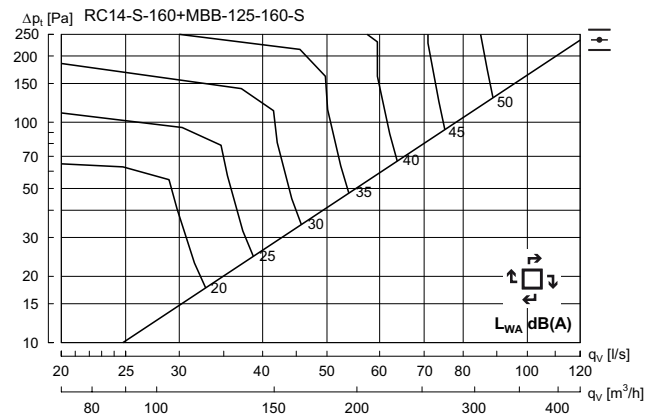

Hz	63	125	250	500	1K	2K	4K	8K
K_{ok}	9	5	0	-1	-5	-13	-19	-25

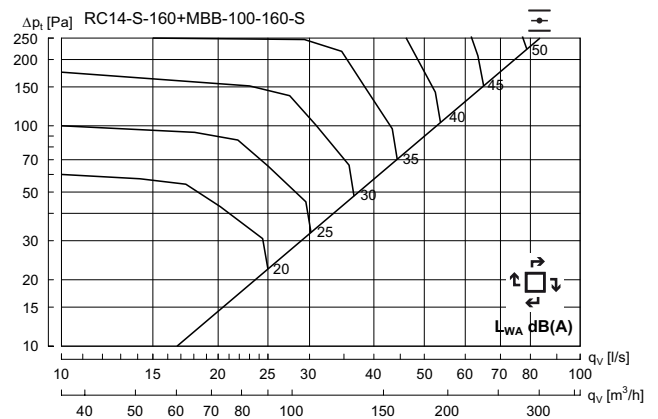

Hz	63	125	250	500	1K	2K	4K	8K
K_{ok}	9	4	0	0	-6	-12	-16	-20

Swirl diffuser

RC14

Technical data

RC14 - 200 + MBB - Supply air

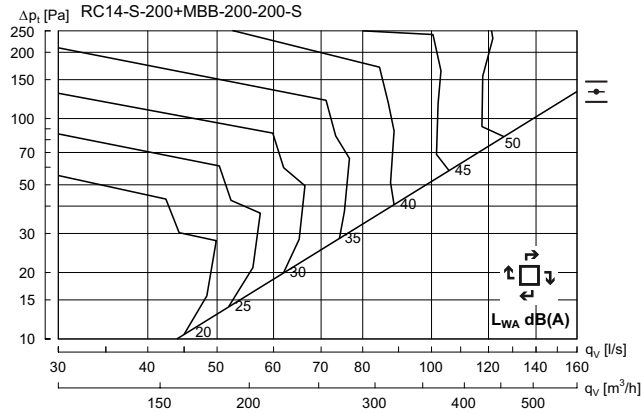

Hz	63	125	250	500	1K	2K	4K	8K
K_{ok}	11	3	-3	-1	-5	-12	-24	-33

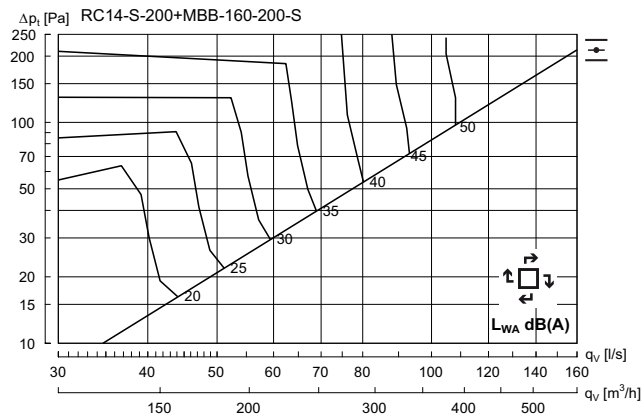

Hz	63	125	250	500	1K	2K	4K	8K
K_{ok}	14	4	-2	-2	-4	-12	-22	-30

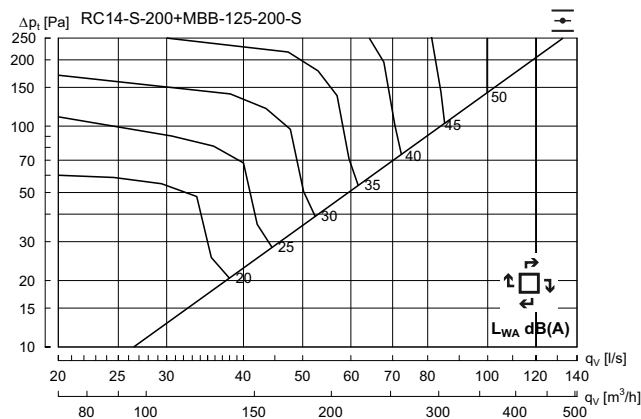

Hz	63	125	250	500	1K	2K	4K	8K
K_{ok}	8	6	1	-2	-6	-12	-17	-23

RC14 - 250 + MBB - Supply air

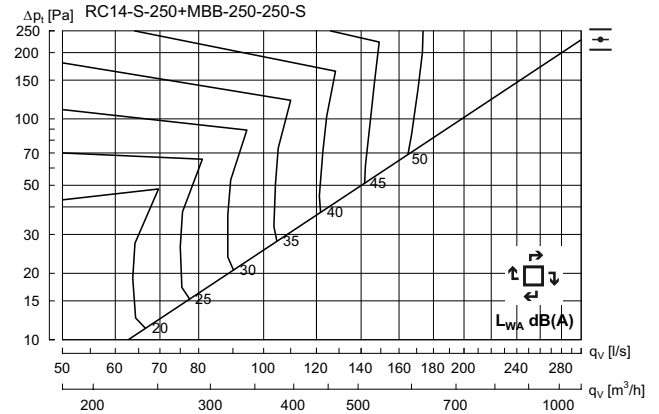

Hz	63	125	250	500	1K	2K	4K	8K
K_{ok}	10	1	-4	-1	-4	-14	-26	-37

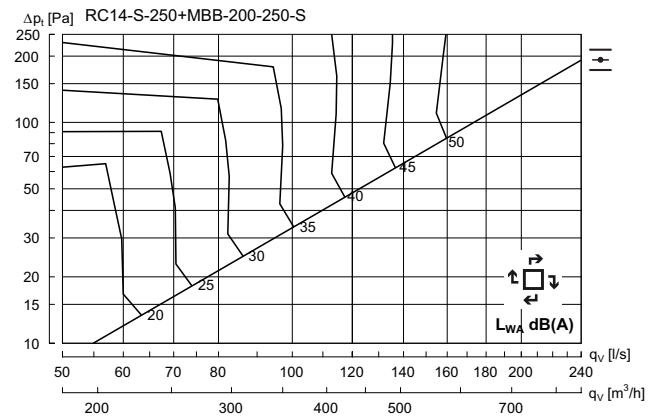

Hz	63	125	250	500	1K	2K	4K	8K
K_{ok}	9	5	-3	-2	-3	-12	-24	-32

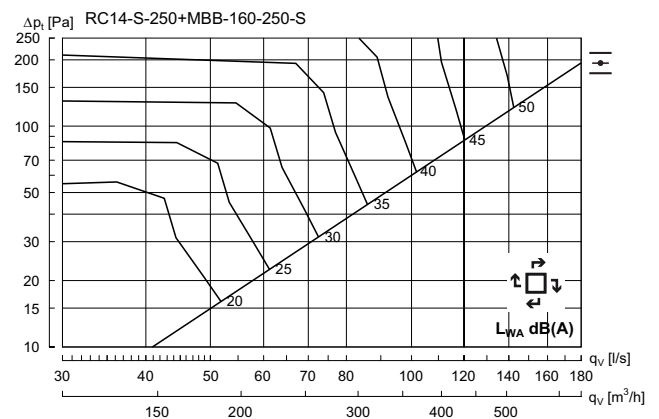

Hz	63	125	250	500	1K	2K	4K	8K
K_{ok}	13	4	-1	-3	-4	-13	-21	-26

Swirl diffuser

RC14

Technical data

RC14 - 315 + MBB - Supply air

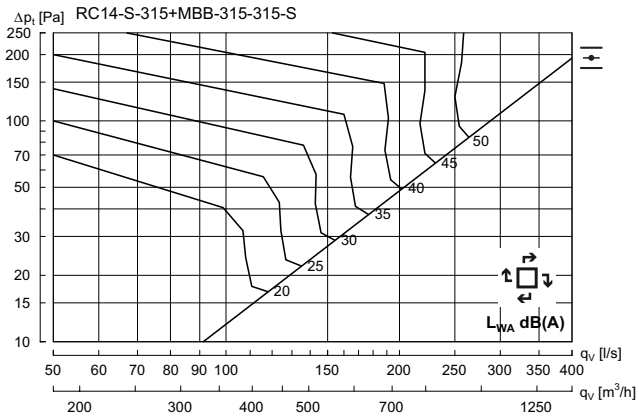

Hz	63	125	250	500	1K	2K	4K	8K
K_{ok}	14	3	-1	-1	-4	-13	-24	-33

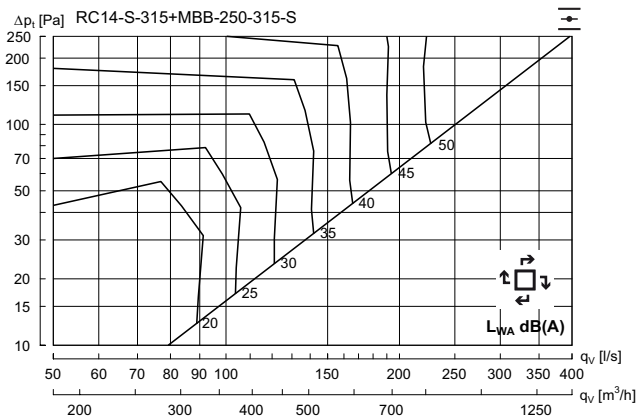

Hz	63	125	250	500	1K	2K	4K	8K
K_{ok}	11	3	-2	-2	-4	-11	-21	-30

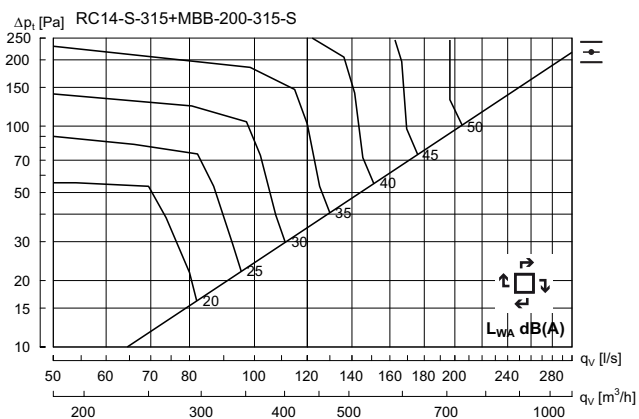

Hz	63	125	250	500	1K	2K	4K	8K
K_{ok}	10	7	-1	-2	-4	-13	-21	-27

Swirl diffuser

RC14

Technical data

RC14 without box – Exhaust air

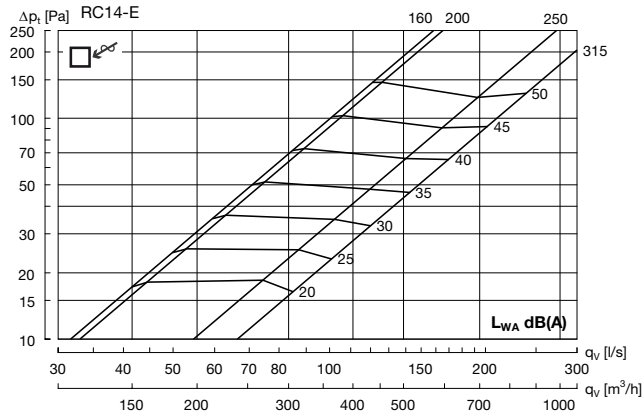

RC14 - 160 + MBB - Exhaust air

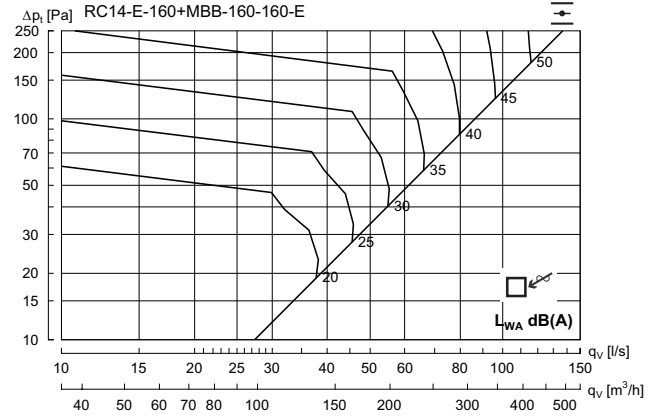

Hz	63	125	250	500	1K	2K	4K	8K
K _{ok}	14	4	-2	-2	-4	-13	-20	-26

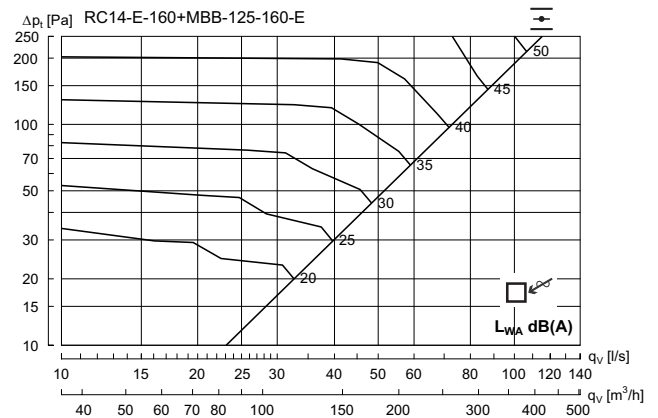

Hz	63	125	250	500	1K	2K	4K	8K
K _{ok}	13	6	1	-1	-6	-13	-16	-22

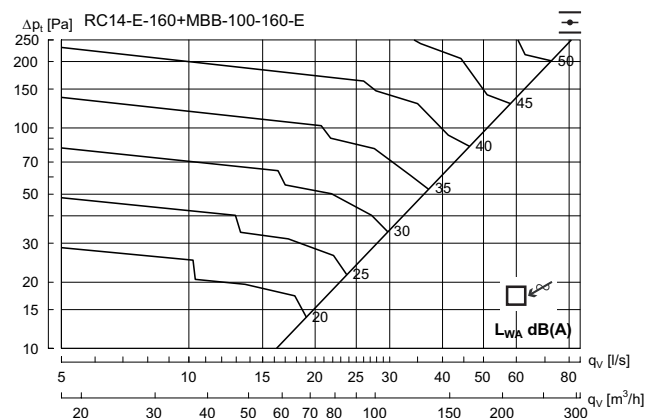

Hz	63	125	250	500	1K	2K	4K	8K
K _{ok}	9	0	4	-1	-10	-12	-18	-24

Swirl diffuser

RC14

Technical data

RC14 - 200 + MBB - Exhaust air

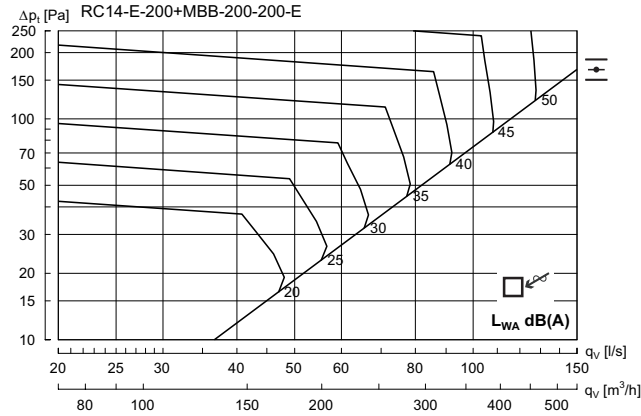

Hz	63	125	250	500	1K	2K	4K	8K
K_{ok}	13	2	-4	-2	-3	-13	-22	-31

RC14 - 250 + MBB - Exhaust air

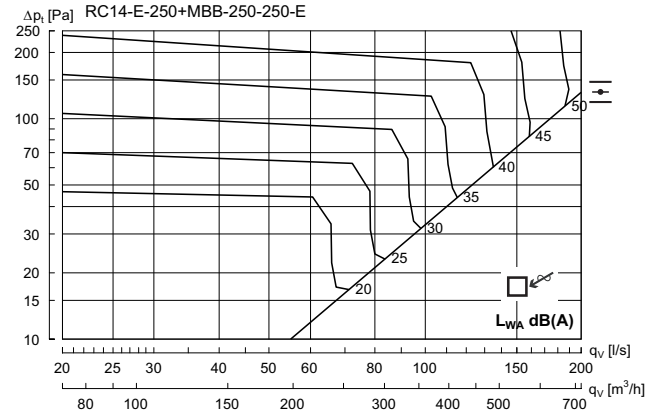

Hz	63	125	250	500	1K	2K	4K	8K
K_{ok}	13	4	0	-2	-4	-12	-22	-31

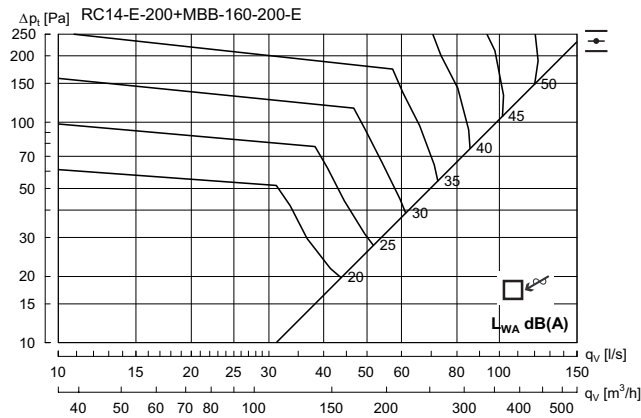

Hz	63	125	250	500	1K	2K	4K	8K
K_{ok}	16	5	-2	-3	-4	-12	-21	-26

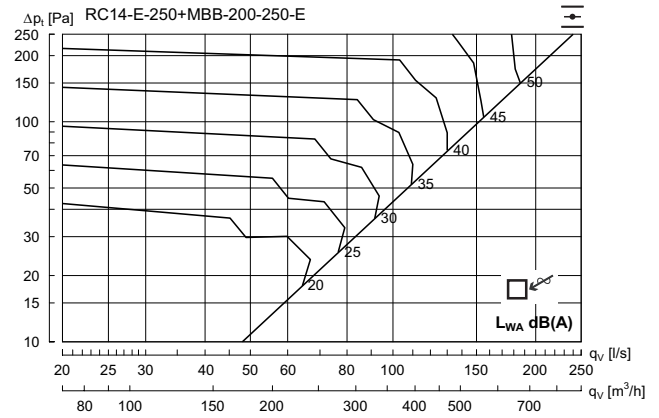

Hz	63	125	250	500	1K	2K	4K	8K
K_{ok}	12	4	0	-2	-4	-11	-19	-27

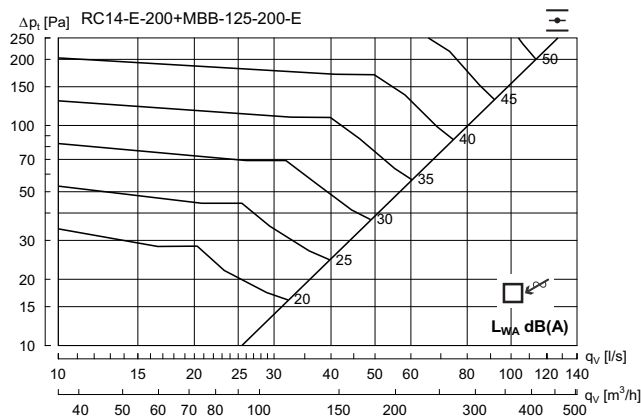

Hz	63	125	250	500	1K	2K	4K	8K
K_{ok}	12	3	1	-1	-6	-12	-17	-23

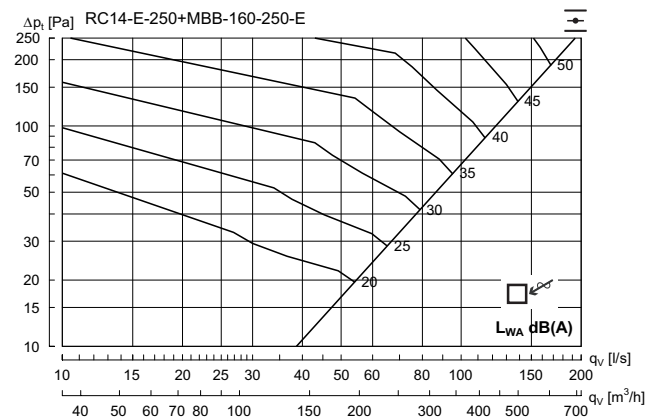

Hz	63	125	250	500	1K	2K	4K	8K
K_{ok}	15	6	0	-2	-6	-11	-16	-22

Swirl diffuser

RC14

Technical data

RC14 - 315 + MBB - Exhaust air

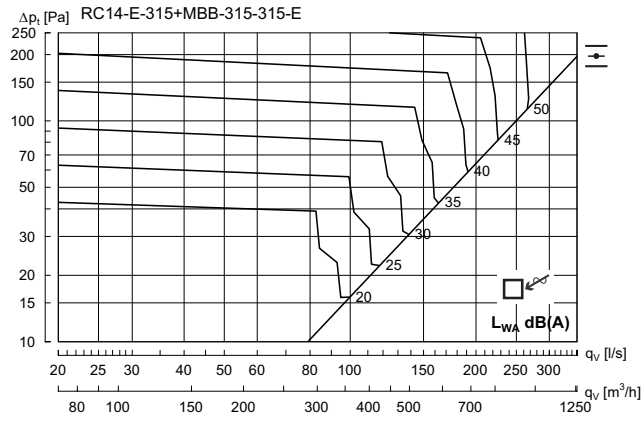

Hz	63	125	250	500	1K	2K	4K	8K
K_{ok}	10	3	1	-2	-4	-16	-24	-34

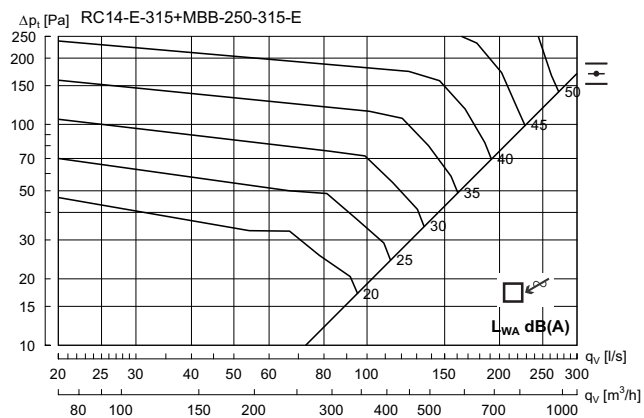

Hz	63	125	250	500	1K	2K	4K	8K
K_{ok}	9	5	1	-2	-5	-13	-18	-26

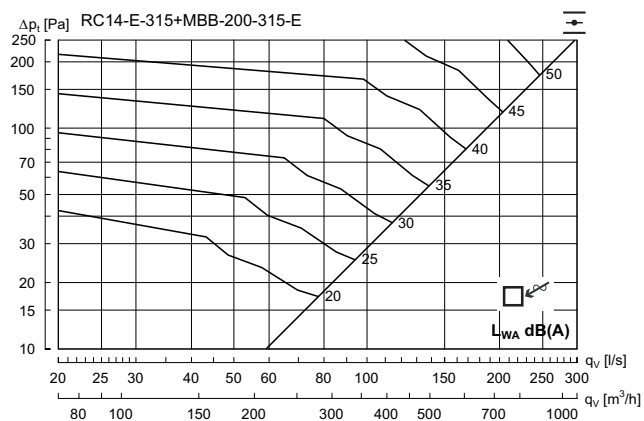

Hz	63	125	250	500	1K	2K	4K	8K
K_{ok}	14	6	1	-2	-6	-11	-16	-24



Swirl diffuser

RC15



Description

RC15 is a circular swirl diffuser with adjustable bars. The diffuser can be used for both supply and exhaust air. The swirl pattern ensures high induction and a large dynamic range, and is therefore ideal for the horizontal supply of very cold air. The diffuser can also be set to a vertical supply air pattern, enabling supply of heated air. Installing this diffuser in a plenum box type MBB can help to achieve a stable flow of air to the diffuser as well as realise the potential for individual adjustment.

- Large dynamic range
- High induction
- Suitable for cooling at very low temperatures
- Horizontal or vertical supply air pattern
- Can be used for both supply air and exhaust

Maintenance

The face plate and swirl insert can be removed to enable cleaning of internal parts or to gain access to the duct or box. The visible parts of the diffuser can be wiped with a damp cloth.

Order code

Product	RC15	a	bbb
Type			
RC15			
Functional use			
S = Supply air			
E = Exhaust Without bars			
Connection dim.			
Ød 160-315			

Example: RC15-S-160

Dimensions

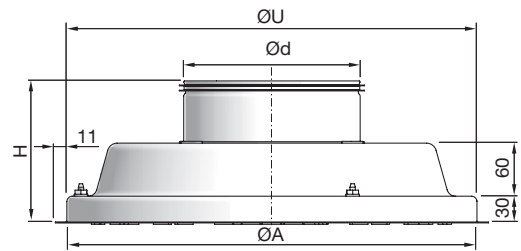

RC15 Ød mm	ØA mm	H mm	ØU* mm	Weight kg
160	360	140	370	5.30
200	360	140	370	5.40
250	460	140	470	7.40
315	540	140	550	8.10

* ØU = ceiling grid opening

Ød 315, No mounting holes for MBB !

Bar settings

Horizontal

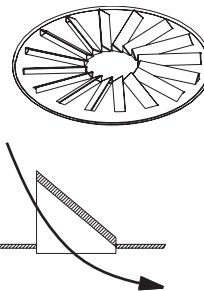

Vertical

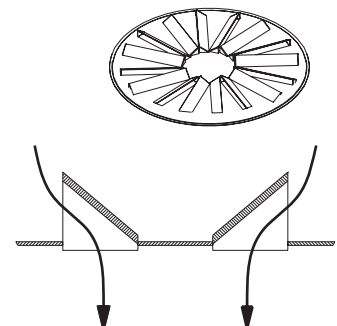

RC15-S



RC15-E

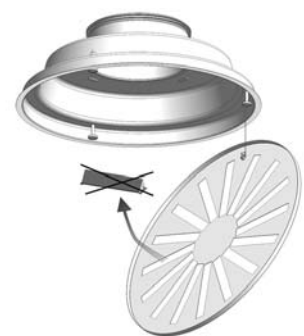

Materials and finish

Material:	Galvanised steel
Standard finish:	Powder-coated
Standard colour:	RAL 9010 Gloss 30
Bars (Only RC15-S):	Black ABS plastic

The diffuser is available in other colours. Please contact Lindab's sales department for further information.

Swirl diffuser

RC15

Accessories

Mounting brackets

DCZ

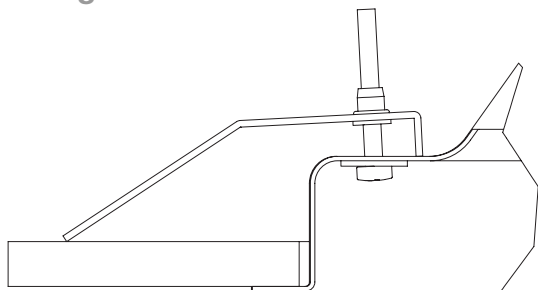

Plenum box

MBB



Extension piece

MBZ

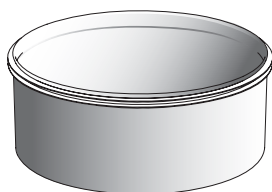

RC15 + MBB

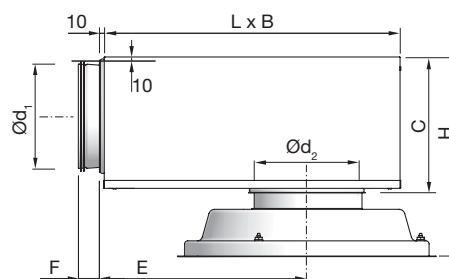

Order code - accessories

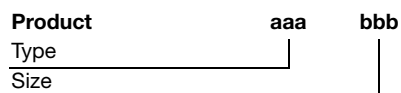

Example: DCZ-160

RC15 + MBB		B	C	E	F	H*	L
duct	RC15	mm	mm	mm	mm	mm	mm
Ød ₁ mm	Ød ₂ mm						
100	160	260	159	216	50	250 - 290	310
125	160	310	184	262	50	275 - 315	376
125	200	310	184	262	50	275 - 315	376
160	160	380	220	323	50	309 - 349	459
160	200	380	220	323	50	309 - 349	459
160	250	380	220	323	50	309 - 349	459
200	200	460	259	396	70	350 - 390	565
200	250	460	259	396	70	350 - 390	565
200	315	460	259	396	70	350 - 390	565
250	250	540	309	486	70	400 - 440	698
250	315	540	309	486	70	400 - 440	698
315	315	540	373	646	70	465 - 505	858

* Using accessory MBZ the H dimension will increase:

Ød₂ = 160 - 200 mm => H +40 mm

Ød₂ = 250 - 315 mm => H +60 mm

Module plate

LM

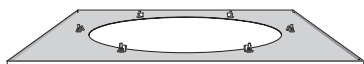

Order code - module plate

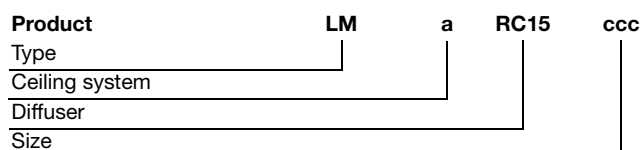

Example: LM-1-RC15-160

Ceiling system - see introductory summary

Order code

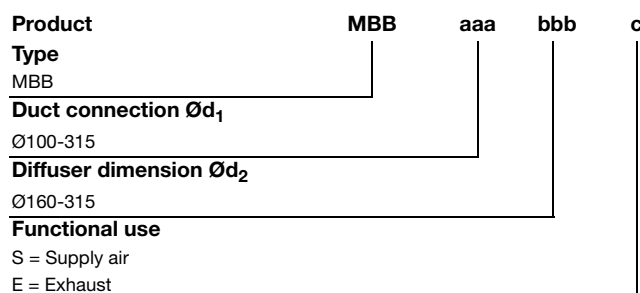

Example: RC15-S-160-MBB-125-160-S

Swirl diffuser

RC15

Technical data

Capacity

Air flow q_v [l/s] and [m³/h], total pressure Δp_t [Pa], throw $l_{0.2}$ [m] and sound power level L_{WA} [dB(A)] can be seen in the diagrams.

Frequency-related sound effect level

The sound effect level in the frequency band is defined as $L_{WA}+K_{ok}$. K_{ok} values are specified in charts beneath the diagrams on the following pages.

Quick selection, supply air

RC15 + MBB		$\Delta p_t \geq 50$ Pa		$\Delta p_t \geq 50$ Pa	
duct	RC15	30 dB(A)		35 dB(A)	
$\varnothing d_1$	$\varnothing d_2$	l/s	m ³ /h	l/s	m ³ /h
100	160	36	130	44	158
125	160	44	158	54	194
125	200	49	176	59	212
160	160	47	169	56	202
160	200	54	194	64	230
160	250	69	248	90	324
200	200	56	202	66	238
200	250	82	295	99	356
200	315	101	364	125	450
250	250	90	324	106	382
250	315	113	407	137	493
315	315	138	497	163	587

Throw $l_{0.2}$

Throw $l_{0.2}$ [m] is specified at a terminal velocity of 0.2 m/s.

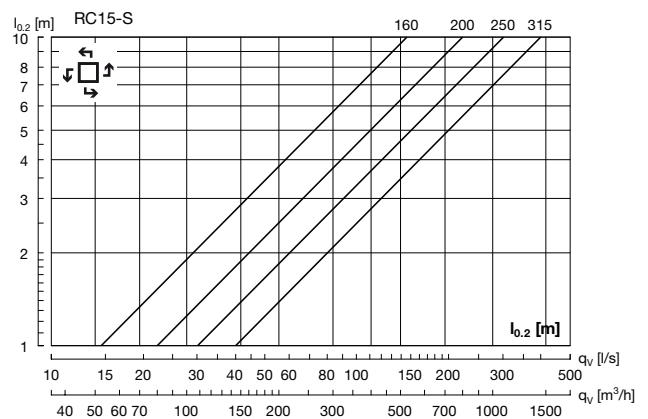
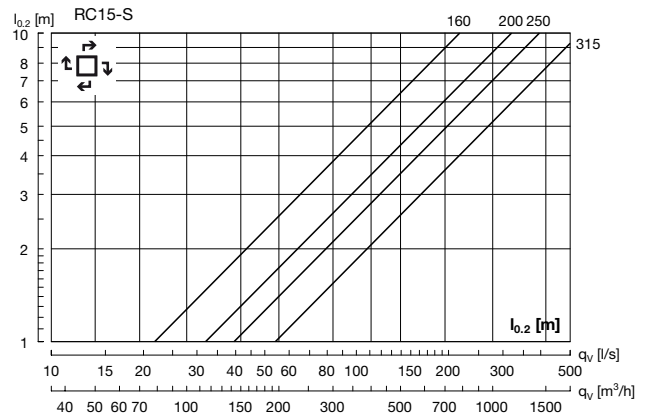

Sound attenuation

Sound attenuation of the diffusers ΔL from duct to room, including end reflection - see table below.

RC15 + MBB		Centre frequency Hz							
duct	RC15	63	125	250	500	1K	2K	4K	8K
$\varnothing d_1$	$\varnothing d_2$								
100	160	17	15	5	12	19	20	20	21
125	160	16	14	8	18	18	20	20	21
125	200	11	12	6	14	14	19	18	19
160	160	16	15	11	22	20	22	21	21
160	200	16	15	9	22	19	21	20	21
160	250	18	14	4	17	14	16	18	19
200	200	13	12	8	17	20	19	21	18
200	250	12	9	6	14	19	16	18	17
200	315	11	8	4	10	17	16	19	17
250	250	13	8	7	15	19	19	18	18
250	315	12	8	6	14	17	17	18	18
315	315	8	9	9	14	18	18	18	23

Balancing

Balancing data is contained in a separate brochure.

Swirl diffuser

RC15

Technical data

Throws/Turning points

Throw $l_{0,2}$ [m] is specified at a terminal velocity of 0.2 m/s.
Turning point $l_{0,0}$ [m] is specified for +5 K and +10 K respectively.

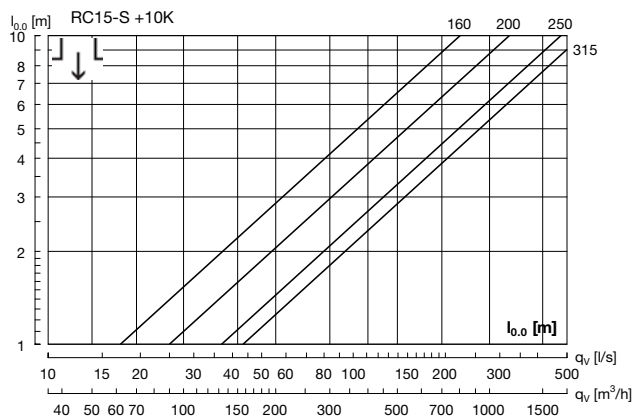
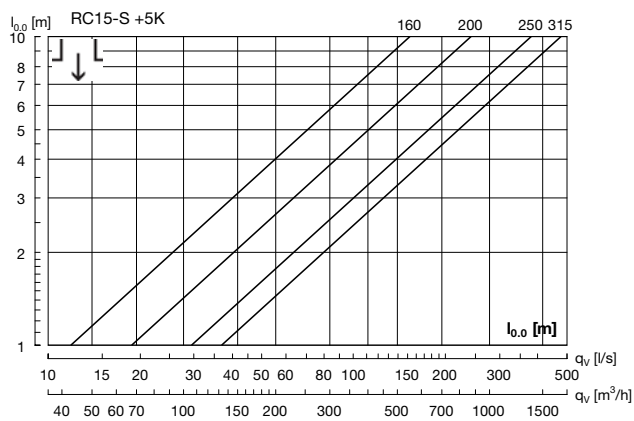
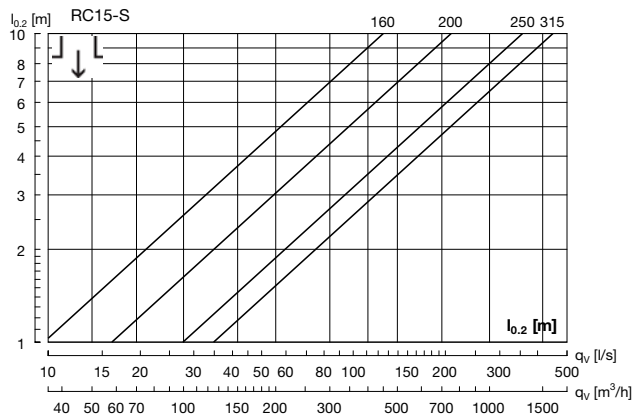

RC15 without box – supply air

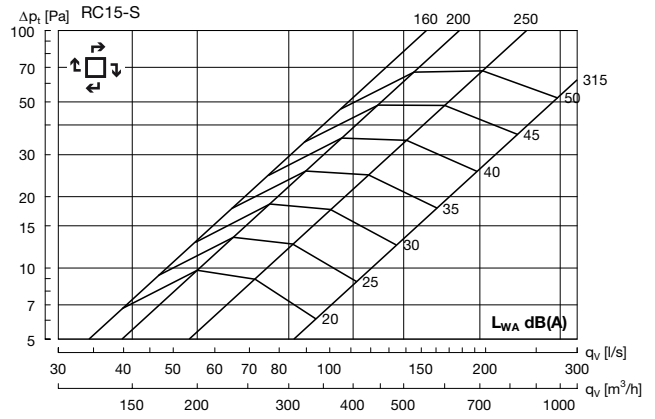

Swirl diffuser

RC15

Technical data

RC15 160 + MBB - Supply air

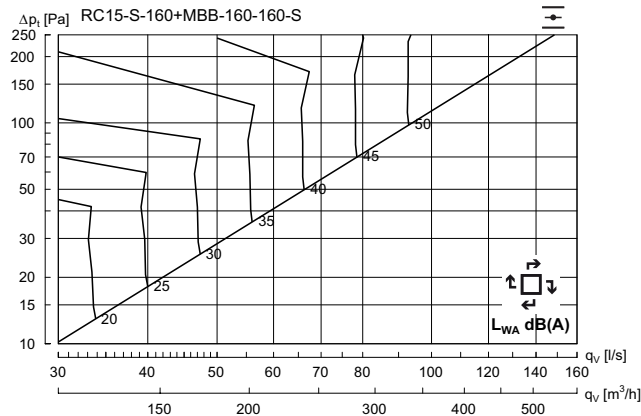

Hz	63	125	250	500	1K	2K	4K	8K
K_{ok}	10	2	-4	0	-5	-17	-23	-31

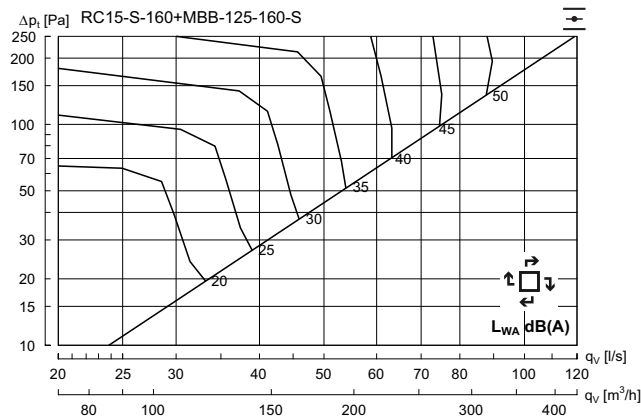

Hz	63	125	250	500	1K	2K	4K	8K
K_{ok}	10	4	-1	0	-6	-13	-18	-24

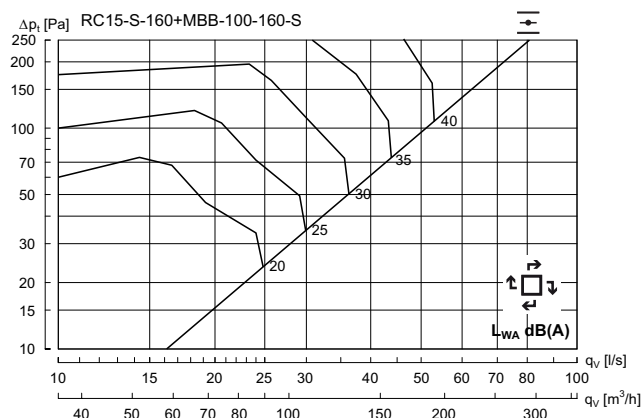

Hz	63	125	250	500	1K	2K	4K	8K
K_{ok}	12	4	2	-1	-8	-12	-16	-19

RC15 - 200 + MBB - Supply air

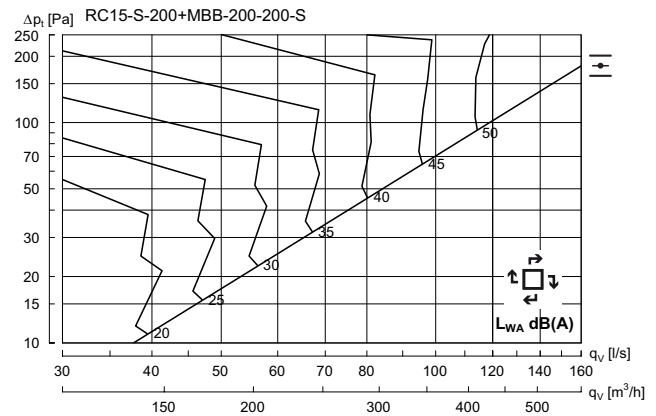

Hz	63	125	250	500	1K	2K	4K	8K
K_{ok}	8	3	-4	-1	-4	-15	-22	-31

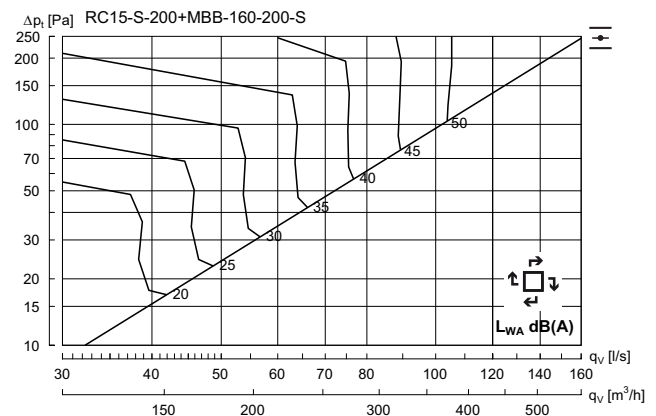

Hz	63	125	250	500	1K	2K	4K	8K
K_{ok}	9	3	-1	-2	-4	-14	-21	-29

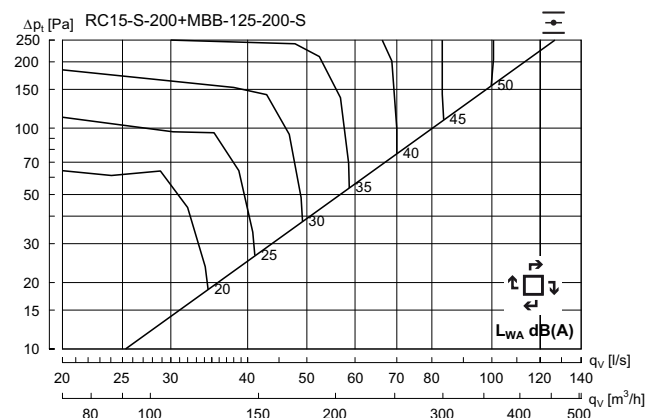

Hz	63	125	250	500	1K	2K	4K	8K
K_{ok}	7	5	0	-1	-5	-13	-17	-24

Swirl diffuser

RC15

Technical data

RC15 - 250 + MBB - Supply air

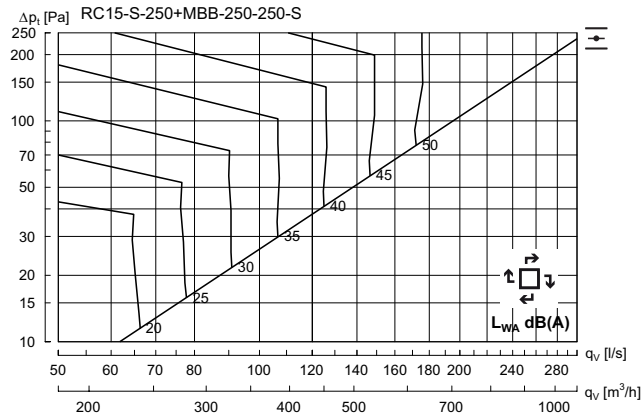

Hz	63	125	250	500	1K	2K	4K	8K
K_{ok}	12	1	-4	0	-4	-16	-24	-20

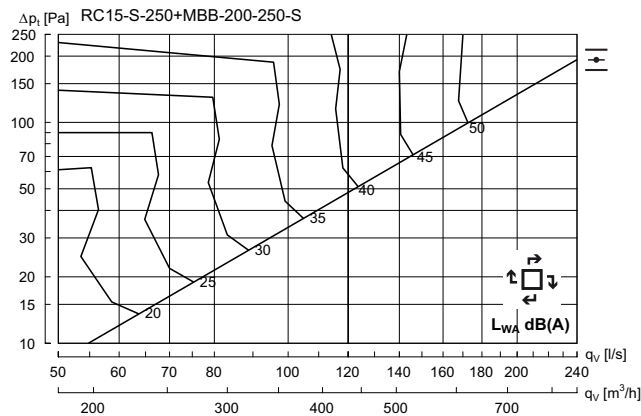

Hz	63	125	250	500	1K	2K	4K	8K
K_{ok}	10	4	-3	-2	-3	-15	-21	-29

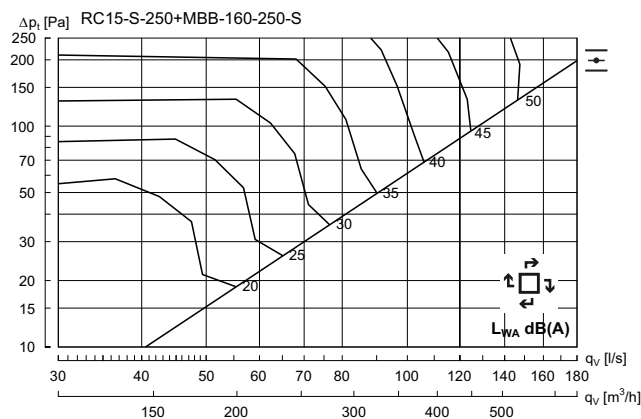

Hz	63	125	250	500	1K	2K	4K	8K
K_{ok}	15	5	0	-3	-4	-13	-19	-25

RC15 - 315 + MBB - Supply air

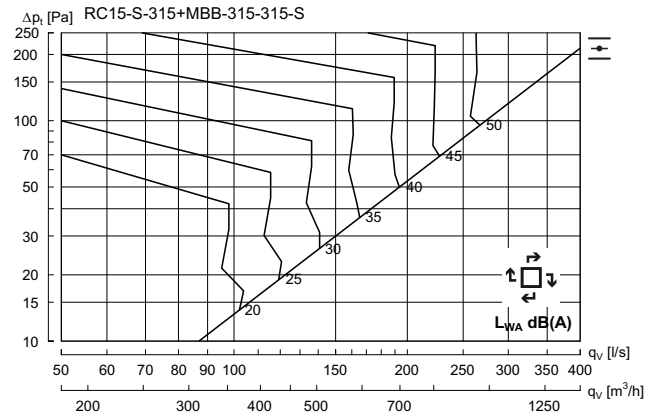

Hz	63	125	250	500	1K	2K	4K	8K
K_{ok}	14	3	-2	-2	-4	-13	-22	-31

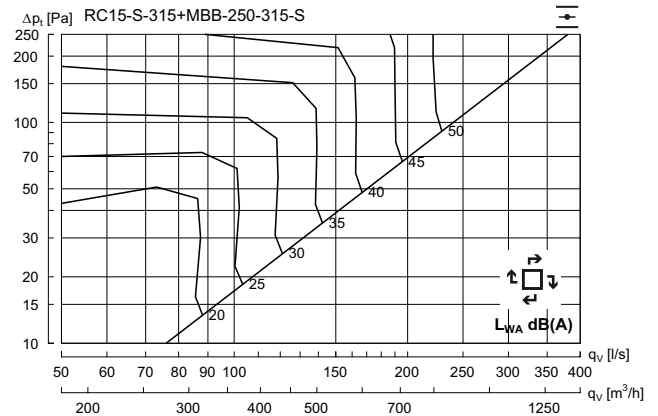

Hz	63	125	250	500	1K	2K	4K	8K
K_{ok}	11	3	-2	-1	-4	-13	-19	-28

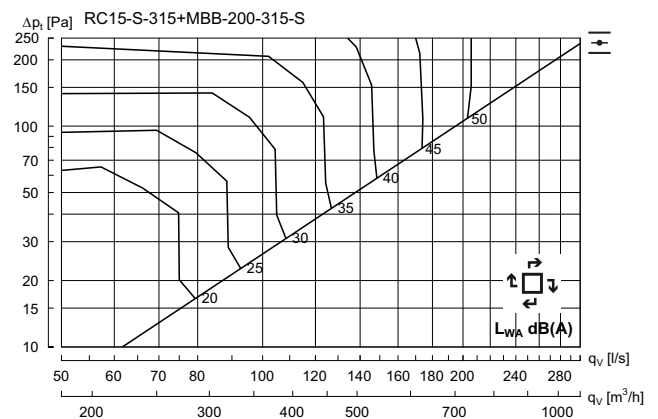

Hz	63	125	250	500	1K	2K	4K	8K
K_{ok}	9	7	-1	-2	-5	-13	-19	-26

Swirl diffuser

RC15

Technical data

RC15 without box – Exhaust air

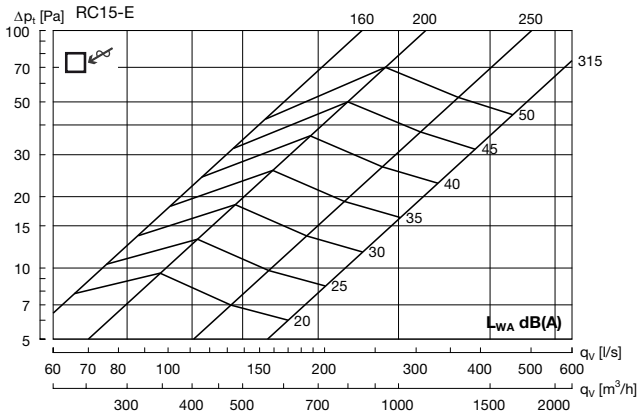

RC15 160 + MBB - Exhaust air

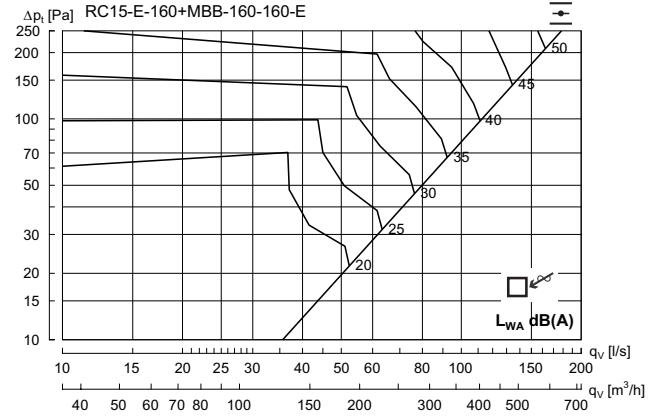

Hz	63	125	250	500	1K	2K	4K	8K
K_{ok}	16	6	0	-3	-6	-11	-16	-21

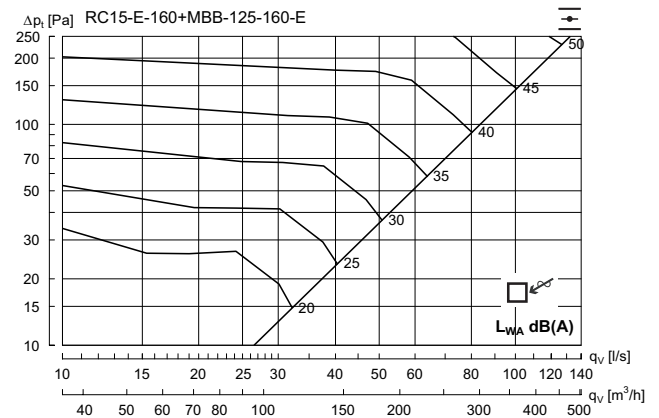

Hz	63	125	250	500	1K	2K	4K	8K
K_{ok}	13	6	1	-2	-7	-12	-14	-22

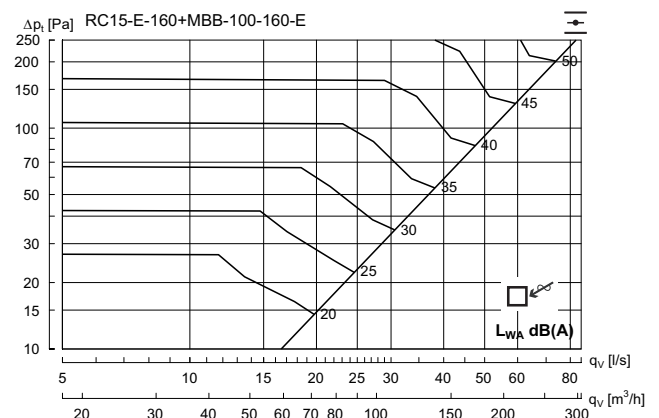

Hz	63	125	250	500	1K	2K	4K	8K
K_{ok}	11	4	3	0	-9	-13	-17	-23

Swirl diffuser

RC15

Technical data

RC15 200 + MBB - Exhaust air

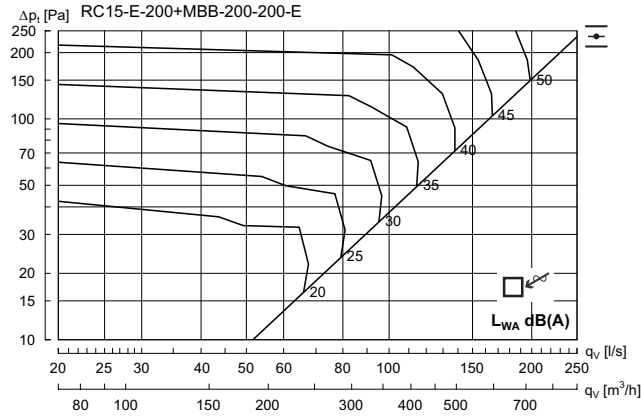

Hz	63	125	250	500	1K	2K	4K	8K
K_{ok}	14	5	0	-2	-5	-11	-16	-24

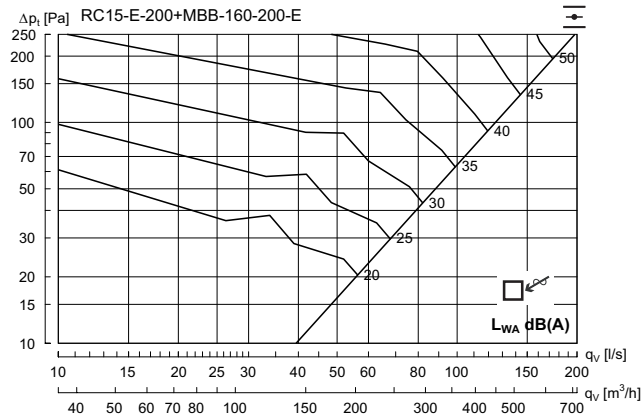

Hz	63	125	250	500	1K	2K	4K	8K
K_{ok}	17	6	-1	-3	-6	-10	-14	-19

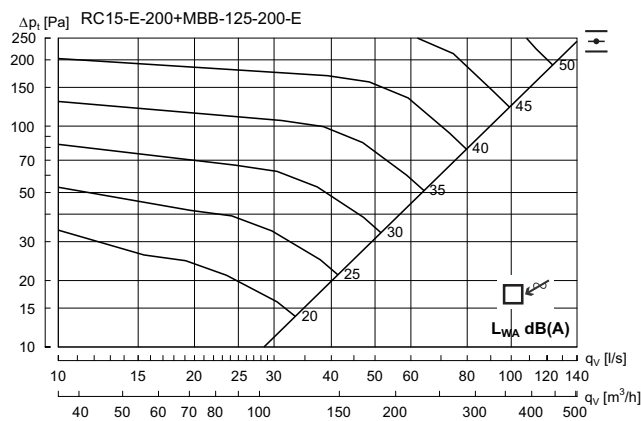

Hz	63	125	250	500	1K	2K	4K	8K
K_{ok}	14	3	1	-1	-6	-12	-15	-22

Technical data

RC15 - 250 + MBB - Exhaust air

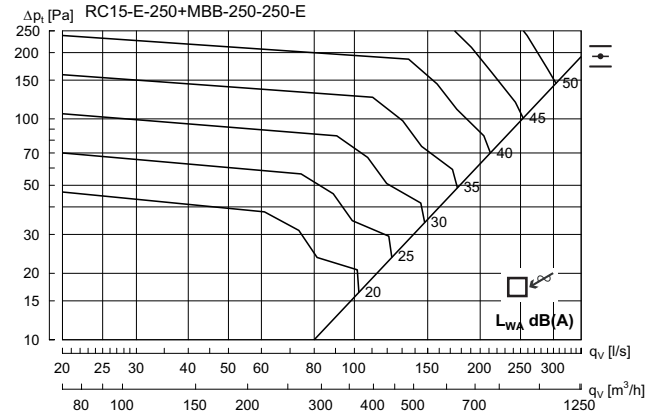

Hz	63	125	250	500	1K	2K	4K	8K
K_{ok}	12	6	2	-3	-6	-12	-17	-24

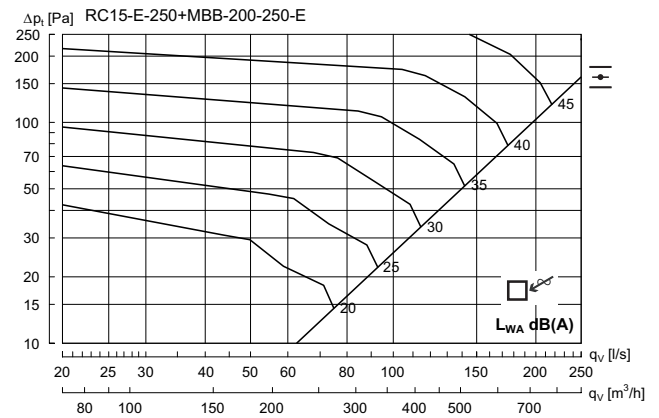

Hz	63	125	250	500	1K	2K	4K	8K
K_{ok}	13	5	0	-3	-6	-10	-14	-23

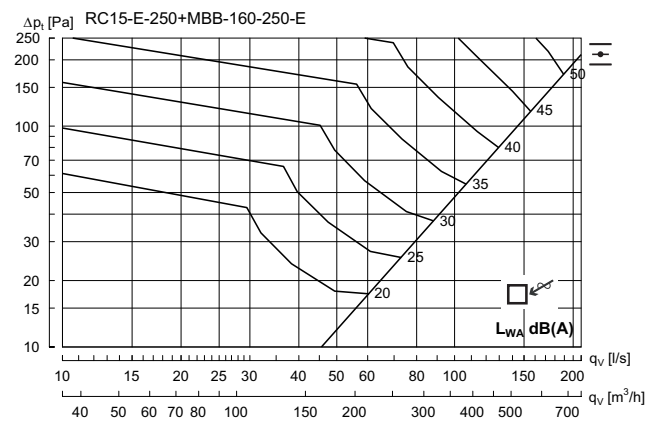

Hz	63	125	250	500	1K	2K	4K	8K
K_{ok}	13	7	0	-3	-6	-10	-15	-19

Swirl diffuser

RC15

Technical data

RC15 - 315 + MBB - Exhaust air

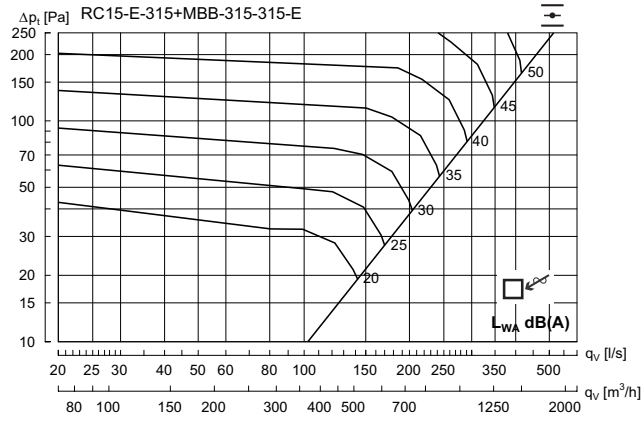

Hz	63	125	250	500	1K	2K	4K	8K
K_{ok}	12	5	3	-3	-6	-11	-16	-25

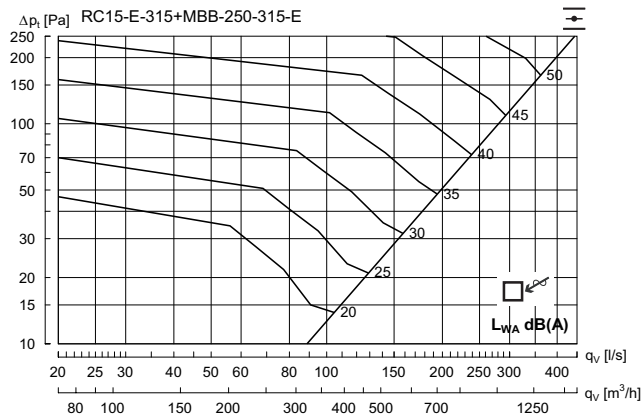

Hz	63	125	250	500	1K	2K	4K	8K
K_{ok}	9	5	2	-3	-5	-11	-17	-25

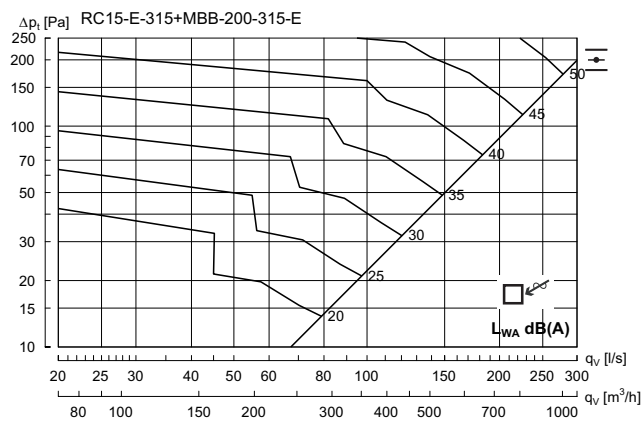

Hz	63	125	250	500	1K	2K	4K	8K
K_{ok}	15	5	1	-3	-5	-10	-15	-23



Nozzle diffuser

NC19



Description

NC19 is a circular diffuser with individually adjustable nozzles. The diffuser is suitable for the horizontal supply of cooled air, where great flexibility in the dispersal pattern is required. The diffuser can also be set to a vertical supply air pattern, enabling supply of heated air. Installing this diffuser in a plenum box type MBB can help to achieve a stable flow of air to the diffuser as well as realise the potential for individual adjustment.

- Adjustable dispersal patterns
- No pressure change for different dispersal patterns
- Suitable for horizontal or vertical supply air patterns

Maintenance

The face plate can be removed to enable cleaning of internal parts or to gain access to the duct or box. The visible parts of the diffuser can be wiped with a damp cloth.

Order code

Product	NC19	-	S	-	aaa
Type	NC19				
Functional use					
Connection dim.					

Example: NC19-S-200

Dimensions

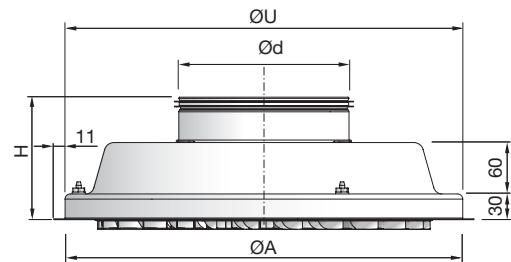

NC19 Ød	ØA	H	ØU*	Weight
mm	mm	mm	mm	kg
125	360	140	370	3.90
160	460	140	470	5.30
200	460	140	470	5.40
250	540	140	550	7.40
315	540	140	550	8.10

* ØU = ceiling grid opening

Ød 315, No mounting holes for MBB !



Materials and finish

Material: Galvanised steel
 Standard finish: Powder-coated
 Standard colour: RAL 9010, Gloss 30
 Nozzles: White ABS plastic

The diffuser is available in other colours. Please contact Lindab's sales department for further information.

Nozzle diffuser

NC19

Accessories

Mounting brackets

DCZ

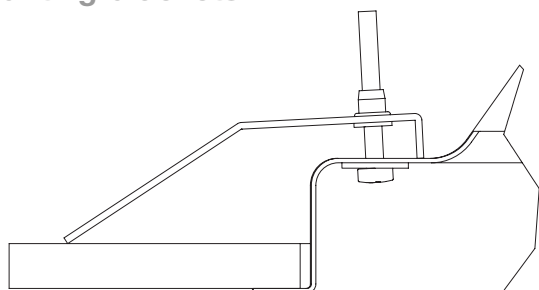

Plenum box

MBB



NC19 + MBB

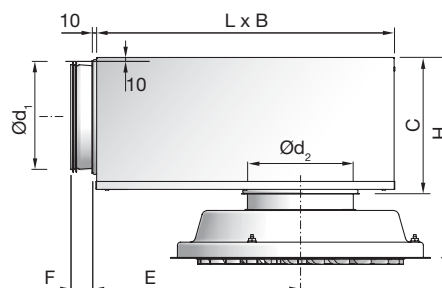

Extension piece

MBZ

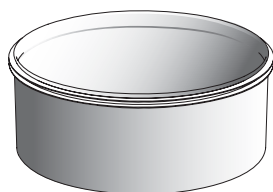

Order code - accessories

Product **aaa** **bbb**
 Type
 Size

Example: DCZ-200

Module plate

LM

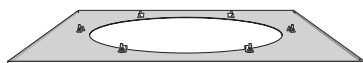

Order code - module plate

Product **LM** **a** **NC19** **ccc**
 Type
 Ceiling system
 Diffuser
 Size

Example: LM-1-NC19-200

Ceiling system - see introductory summary

NC19 + MBB		B	C	E	F	H*	L
duct	NC19	mm	mm	mm	mm	mm	mm
Ød ₁	Ød ₂						
100	125	260	159	216	50	250 - 290	310
100	160	260	159	216	50	250 - 290	310
125	125	310	184	262	50	275 - 315	376
125	160	310	184	262	50	275 - 315	376
125	200	310	184	262	50	275 - 315	376
160	160	380	220	323	50	309 - 349	459
160	200	380	220	323	50	309 - 349	459
160	250	380	220	323	50	309 - 349	459
200	200	460	259	396	70	350 - 390	565
200	250	460	259	396	70	350 - 390	565
200	315	460	259	396	70	350 - 390	565
250	250	540	309	486	70	400 - 440	698
250	315	540	309	486	70	400 - 440	698
315	315	540	373	646	70	465 - 505	858

* Using accessory MBZ the H dimension will increase:
 Ød₂ = 125 - 200 mm => H +40 mm
 Ød₂ = 250 - 315 mm => H +60 mm

Order code

Product **MBB** - **aaa** - **bbb** - **S**
 Type
 MBB
 Duct connection Ød₁
 Ø100-315
 Diffuser dimension Ød₂
 Ø125-315
 Functional use
 S = Supply air

Example: NC19-S-200-MBB-200-200-S

Nozzle diffuser

NC19

Technical data

Capacity

Air flow q_v [l/s] and [m³/h], total pressure Δp_t [Pa], throw $l_{0.2}$ [m] and sound power level L_{WA} [dB(A)] can be seen in the diagrams.

Frequency-related sound effect level

The sound effect level in the frequency band is defined as $L_{WA} + K_{ok}$. K_{ok} values are specified in chart beneath the diagrams on the following pages.

Quick selection, supply air

NC19 + MBB		$\Delta p_t \geq 50$ Pa		$\Delta p_t \geq 50$ Pa	
duct	NC19	30 dB(A)		35 dB(A)	
$\varnothing d_1$	$\varnothing d_2$	l/s	m ³ /h	l/s	m ³ /h
100	125	25	90	33	119
100	160	39	140	47	169
125	125	35	126	41	148
125	160	48	173	59	212
125	200	54	194	64	230
160	160	52	187	63	227
160	200	59	212	72	259
160	250	76	274	96	346
200	200	66	238	80	288
200	250	92	331	112	403
200	315	97	349	120	432
250	250	100	360	119	428
250	315	109	392	131	472
315	315	121	436	143	515



Throw $l_{0.2}$

Throw $l_{0.2}$ [m] is specified at a terminal velocity of 0.2 m/s.

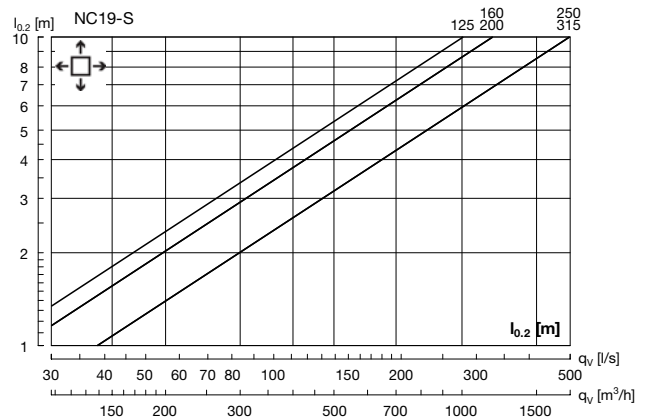
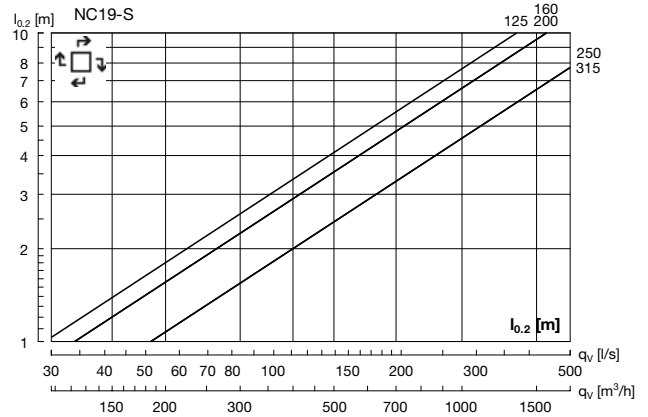

Sound attenuation

Sound attenuation of the diffusers ΔL from duct to room, including end reflection, see table below

NC19 + MBB		Centre frequency Hz							
duct	NC19	63	125	250	500	1K	2K	4K	8K
$\varnothing d_1$	$\varnothing d_2$								
100	125	20	16	6	15	20	20	19	23
100	160	16	16	4	13	18	19	17	21
125	125	17	15	10	19	20	20	19	22
125	160	15	14	7	18	18	18	18	21
125	200	13	12	5	15	15	16	17	19
160	160	16	15	11	22	20	20	20	20
160	200	16	15	8	21	19	19	19	21
160	250	16	14	5	17	14	16	18	19
200	200	15	10	8	16	20	18	20	18
200	250	13	9	5	13	17	15	19	17
200	315	13	9	4	11	16	15	17	17
250	250	14	8	8	16	18	18	18	19
250	315	14	8	6	14	17	16	17	18
315	315	8	10	9	14	17	17	18	24

Balancing

Balancing data is contained in a separate brochure.

Nozzle diffuser

NC19

Technical data

Throws/Turning points

Throw $l_{0,2}$ [m] is specified at a terminal velocity of 0.2 m/s.
Turning point $l_{0,0}$ [m] is specified for +5 K and +10 K respectively.

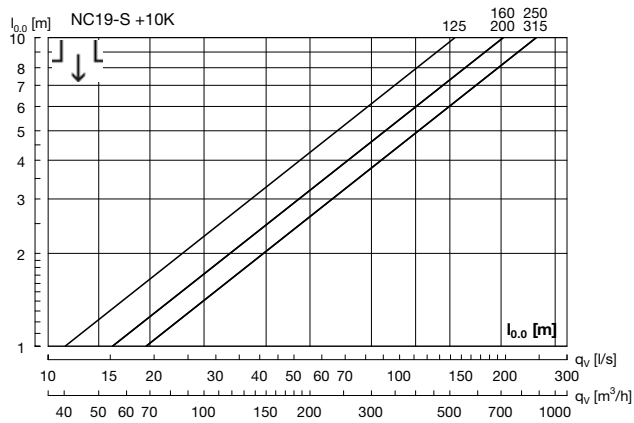
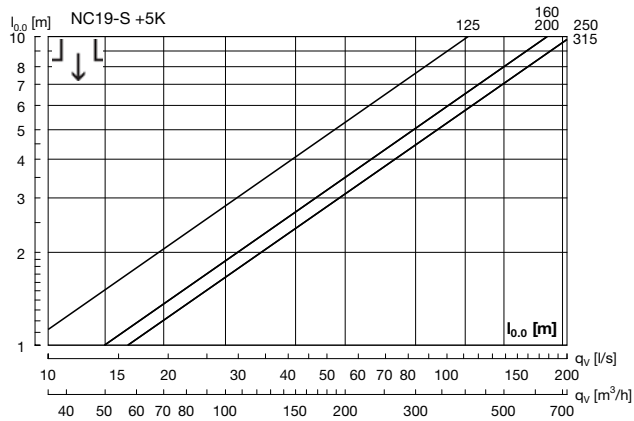
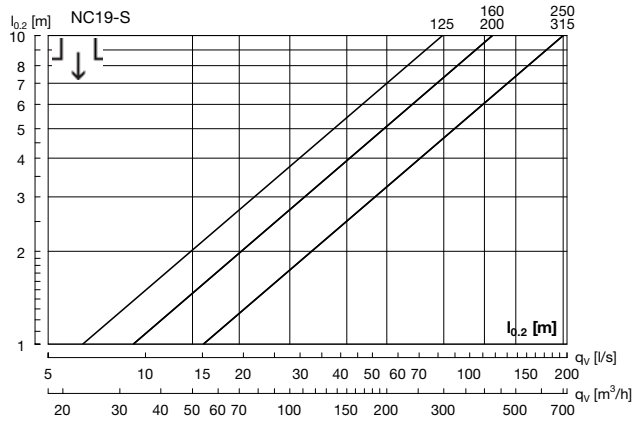

NC19 without box – Supply air

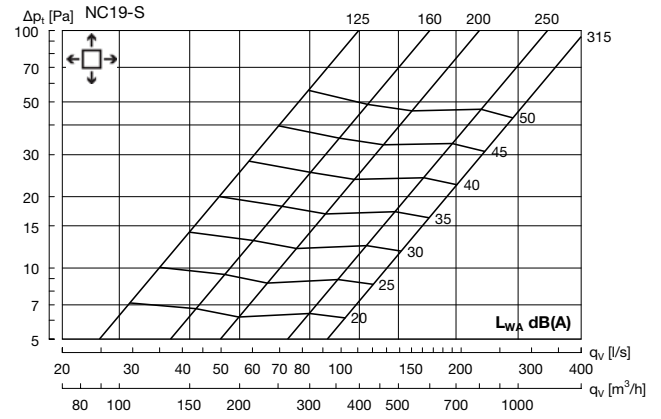

Nozzle diffuser

NC19

Technical data

NC19 - 125 + MBB - Supply air

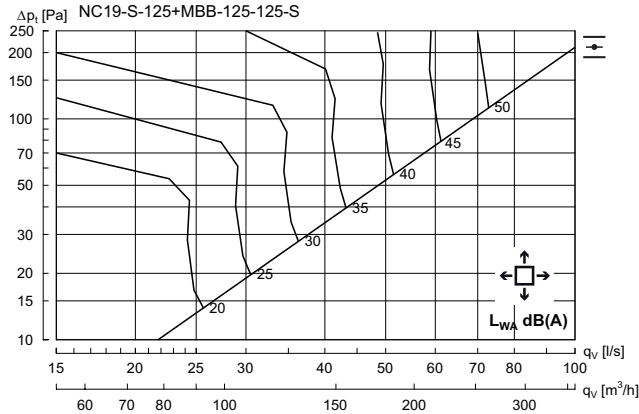

Hz	63	125	250	500	1K	2K	4K	8K
K_{ok}	11	1	-4	0	-5	-15	-23	-35

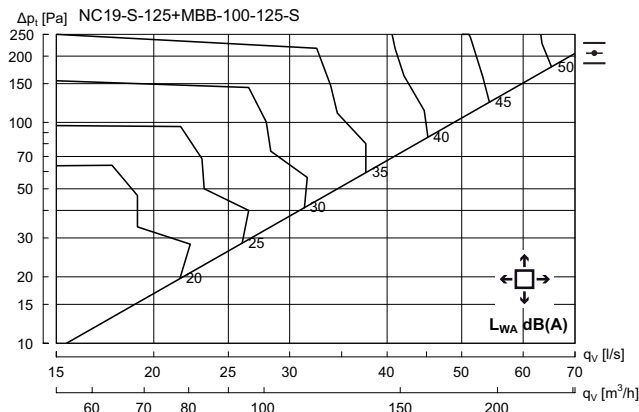

Hz	63	125	250	500	1K	2K	4K	8K
K_{ok}	10	3	2	0	-7	-15	-22	-27

NC19 - 160 + MBB - Supply air

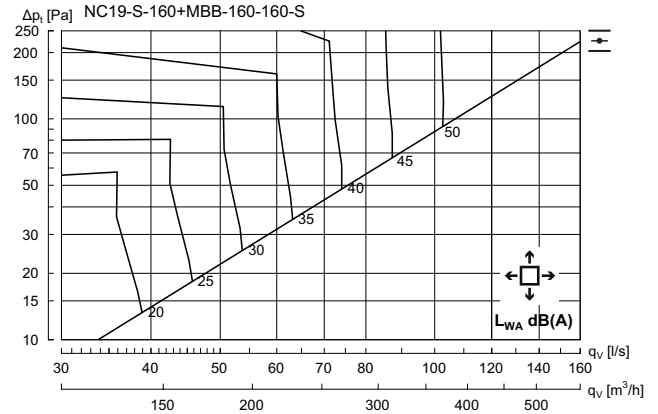

Hz	63	125	250	500	1K	2K	4K	8K
K_{ok}	6	5	-3	-1	-4	-14	-21	-32

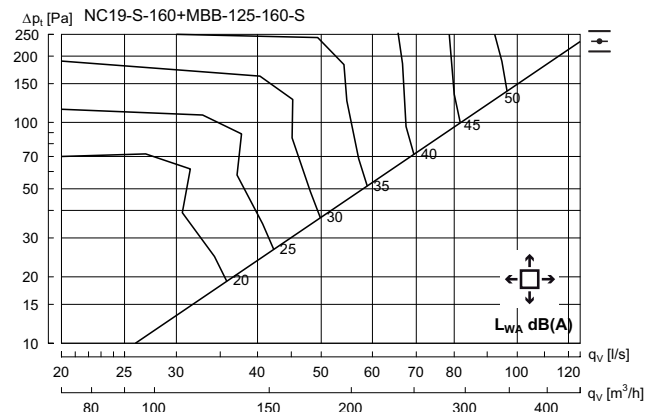

Hz	63	125	250	500	1K	2K	4K	8K
K_{ok}	8	5	-1	-1	-6	-13	-17	-25

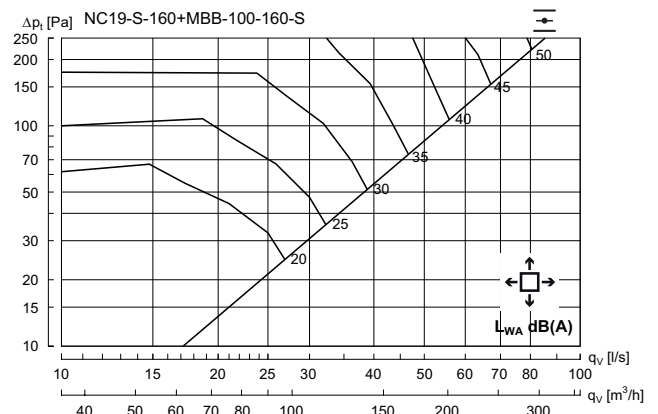

Hz	63	125	250	500	1K	2K	4K	8K
K_{ok}	10	4	1	0	-8	-12	-16	-21

Nozzle diffuser

NC19

Technical data

NC19 - 200 + MBB - Supply air

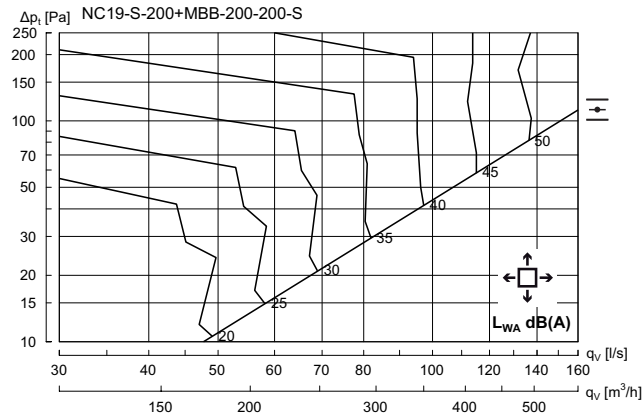

Hz	63	125	250	500	1K	2K	4K	8K
K_{ok}	11	2	-5	0	-4	-16	-23	-33

NC19 - 250 + MBB - Supply air

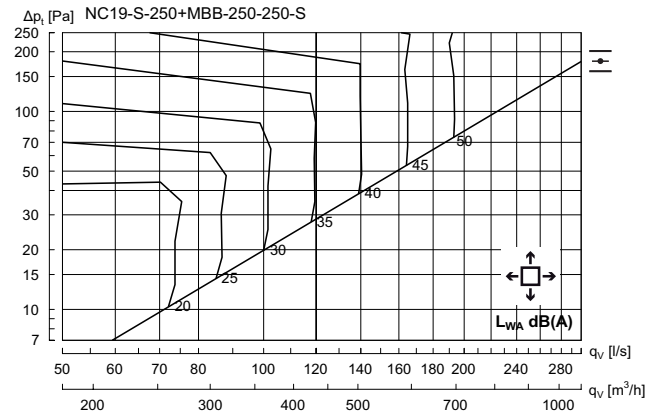

Hz	63	125	250	500	1K	2K	4K	8K
K_{ok}	10	3	-4	-1	-4	-15	-23	-34

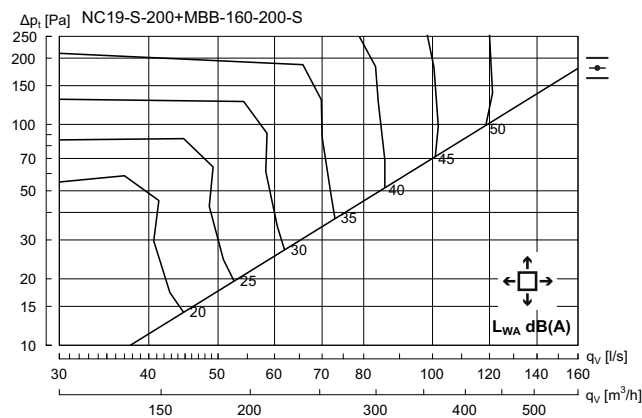

Hz	63	125	250	500	1K	2K	4K	8K
K_{ok}	9	4	-2	-1	-5	-14	-20	-28

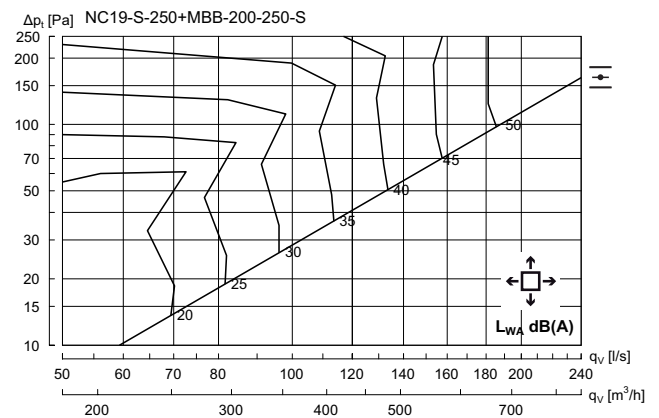

Hz	63	125	250	500	1K	2K	4K	8K
K_{ok}	6	7	-2	-1	-4	-14	-20	-29

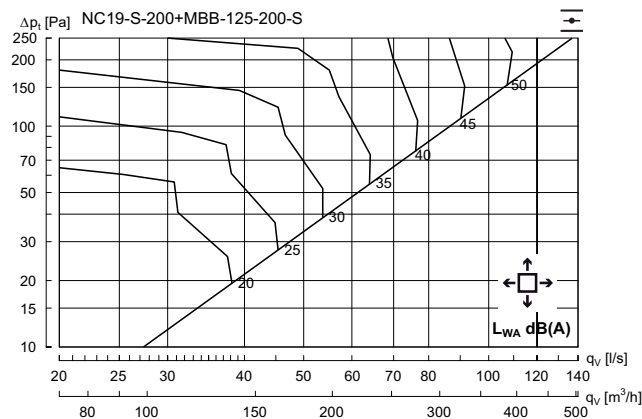

Hz	63	125	250	500	1K	2K	4K	8K
K_{ok}	6	5	0	0	-6	-12	-17	-25

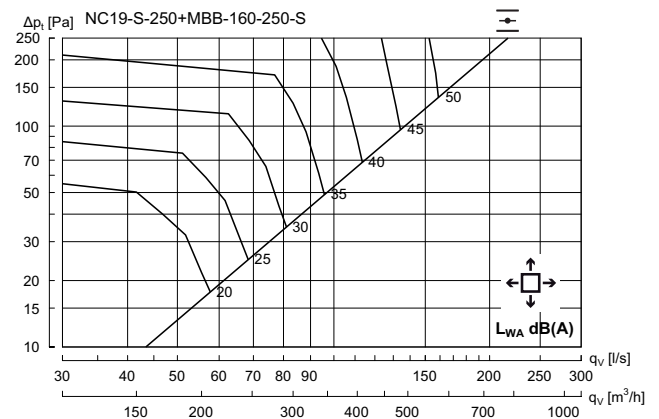

Hz	63	125	250	500	1K	2K	4K	8K
K_{ok}	11	6	1	-2	-5	-12	-18	-26

Nozzle diffuser

NC19

Technical data

NC19 - 315 + MBB - Supply air

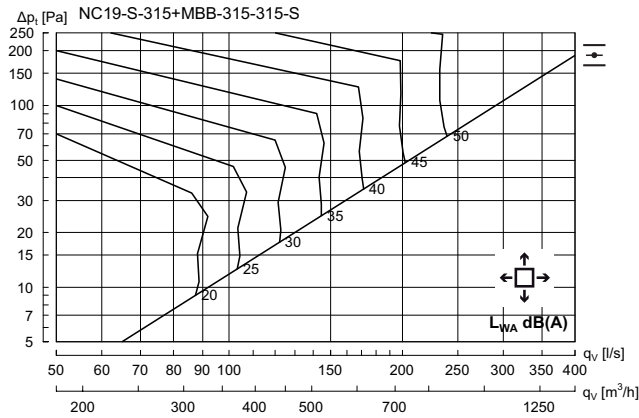

Hz	63	125	250	500	1K	2K	4K	8K
K_{ok}	9	1	-4	-1	-3	-17	-26	-40

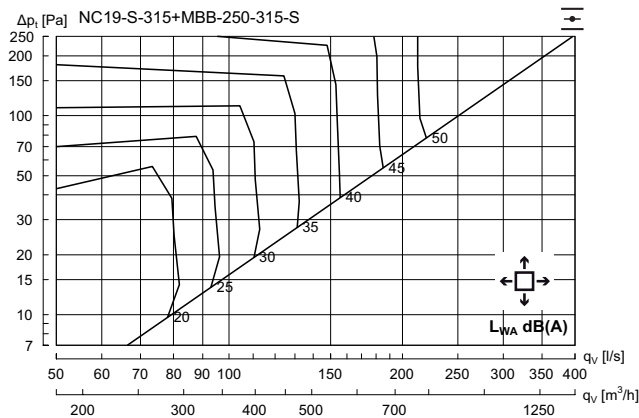

Hz	63	125	250	500	1K	2K	4K	8K
K_{ok}	9	4	-2	-1	-4	-15	-23	-30

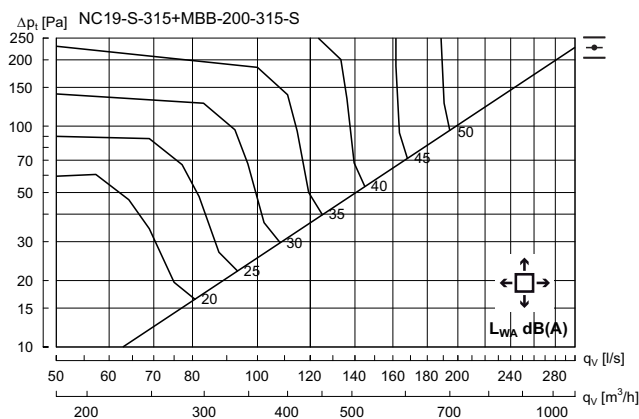

Hz	63	125	250	500	1K	2K	4K	8K
K_{ok}	8	7	0	-2	-5	-14	-20	-30



Swirl diffuser

RCG



Dimensions

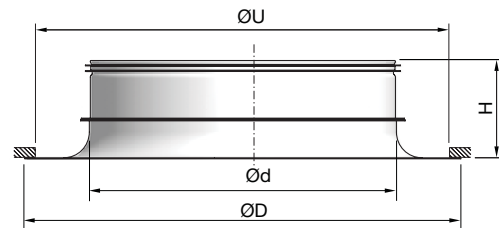

RCG Ød	ØD	H	ØU	Free area A	Weight
mm	mm	mm	mm	m ²	kg
125	200	70	150	0,0031	0,40
160	250	70	200	0,0072	0,50
200	300	70	250	0,0106	0,60
250	350	90	300	0,0189	0,80
315	450	100	400	0,027	1,00
400	570	150	500	0.039	1,50

* ØU = Cutting dimension

Description

RCG is a circular swirl diffuser with fixed bars. RCG is suitable for the horizontal supply of very cold air. The swirl pattern ensures optimum distribution and high induction, as well as a large dynamic range. Installing a RCG diffuser in a plenum box type MBB can help to achieve a stable flow of air to the diffuser as well as realise the potential for individual adjustment. RCG can also be installed directly in the duct using the traverse bracket GRZ1, which is available as an accessory.

- Large dynamic range
- High induction
- Suitable for cooling at very low temperatures

Maintenance

Diffusers are removed to enable cleaning of the plenum box or duct system. The visible parts of the diffuser can be wiped with a damp cloth.

Order code

Product	RCG	aaa
Type	RCG	
Connection dim.	Ød 125-400	

Example: RCG-315

Materials and finish

Material: Steel
 Standard finish: Powder-coated
 Standard colour: RAL 9010 Gloss 30

The diffuser is available in other colours. Please contact Lindab's sales department for further information.

Swirl diffuser

RCG

Accessories

1 **1** Traverse bracket

GRZ1



2 **2** Extension piece

MBZ

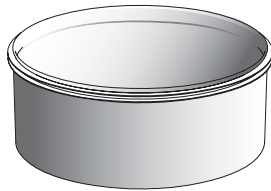

Order code - accessoires

Product	aaa	bbb
Type		
Size		

Example: GRZ1-315

3 **3** Module plate

LM

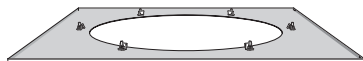

Order code - module plate

Product	LM	a	RCG	ccc
Type				
Ceiling system				
Diffuser				
Size				

Example: LM-1-RCG-315

Ceiling system - see introductory summary

Dimensions

4 **4** Plenum box

MBB

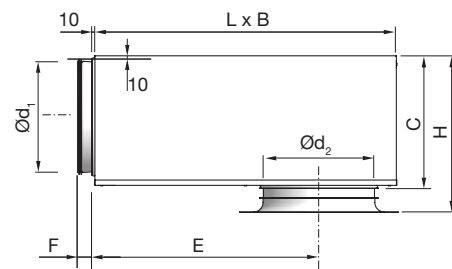

RCG + MBB

RCG + MBB		B	C	E	F	H*	L
duct	RCG	mm	mm	mm	mm	mm	mm
Ød ₁ mm	Ød ₂ mm						
100	125	260	159	216	50	185 - 215	310
100	160	260	159	216	50	185 - 215	310
125	125	310	184	262	50	210 - 240	376
125	160	310	184	262	50	210 - 240	376
125	200	310	184	262	50	210 - 240	376
160	160	380	220	323	50	244 - 274	459
160	200	380	220	323	50	244 - 274	459
160	250	380	220	323	50	264 - 304	459
200	200	460	259	396	70	305 - 345	565
200	250	460	259	396	70	325 - 365	565
200	315	460	259	396	70	325 - 365	565
250	250	540	309	486	70	360 - 400	698
250	315	540	309	486	70	360 - 400	698
250	400	540	309	486	70	410 - 450	698
315	315	540	373	646	70	425 - 465	858
315	400	540	373	646	70	475 - 515	858

* Using accessory MBZ the H dimension will increase:

Ød₂ = 125 - 200 mm => H +40 mm

Ød₂ = 250 - 315 mm => H +60 mm

Ød₂ = 400 mm => H +80 mm

Order code

Product	MBB	aaa	bbb	S
Type				
MBB				
Duct connection Ød ₁				
Ø100-315				
Diffuser dimension Ød ₂				
Ø125-400				
Functional use				
S = Supply air				

Example: RCG-315-MBB-315-315-S

Swirl diffuser

RCG

Technical data

Capacity

Air flow q_v [l/s] and [m³/h], total pressure Δp_t [Pa], throw $l_{0.2}$ [m] and sound power level L_{WA} [dB(A)] can be seen in the diagrams.

Frequency-related sound effect level

The sound effect level in the frequency band is defined as $L_{WA}+K_{ok}$. K_{ok} values are specified in charts beneath the diagrams on the following pages.

Quick selection, supply air

RCG + MBB		$\Delta p_t \geq 50$ Pa		$\Delta p_t \geq 50$ Pa	
duct	RCG	30 dB(A)		35 dB(A)	
$\varnothing d_1$	$\varnothing d_2$	l/s	m ³ /h	l/s	m ³ /h
100	125	17	61	20	72
100	160	28	101	33	119
125	125	20	72	24	86
125	160	32	115	39	140
125	200	42	151	52	187
160	160	34	122	41	148
160	200	48	173	59	212
160	250	60	216	76	274
200	200	50	180	63	227
200	250	67	241	84	302
200	315	90	324	111	400
250	250	76	274	93	335
250	315	99	356	122	439
250	400	109	392	143	515
315	315	119	428	142	511
315	400	142	511	177	637

Throw $l_{0.2}$

Throw $l_{0.2}$ [m] is specified at a terminal velocity of 0.2 m/s.

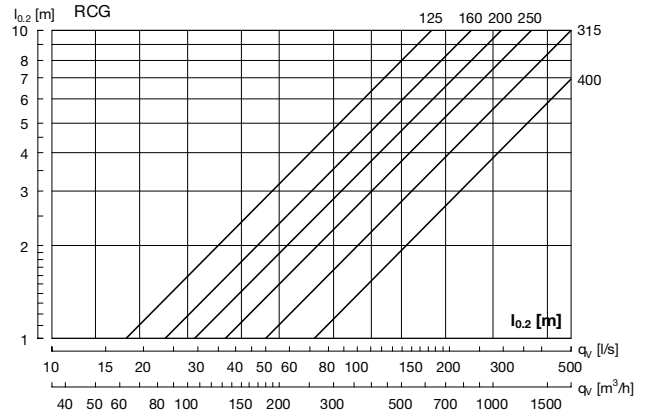

Sound attenuation

Sound attenuation of the diffusers ΔL from duct to room, including end reflection - see table below.

RCG + MBB		Centre frequency Hz							
duct	RCG	63	125	250	500	1K	2K	4K	8K
$\varnothing d_1$	$\varnothing d_2$								
100	125	20	16	7	18	19	18	17	21
100	160	19	16	5	17	17	16	16	19
125	125	17	15	9	21	17	19	18	20
125	160	13	14	8	20	14	16	16	20
125	200	13	12	5	17	13	14	15	18
160	160	18	15	9	22	18	17	19	20
160	200	17	15	8	21	17	16	18	19
160	250	16	15	4	17	14	14	16	18
200	200	14	9	8	18	18	15	18	17
200	250	13	10	5	15	17	14	17	16
200	315	11	8	3	13	15	13	16	16
250	250	15	8	8	15	17	16	17	18
250	315	15	7	6	13	15	14	16	17
250	400	14	5	4	12	13	13	14	16
315	315	7	10	9	13	16	15	17	21
315	400	7	8	9	12	15	15	16	19

Balancing

Balancing data is contained in a separate brochure.

Swirl diffuser

RCG

Technical data

RCG without box – supply air

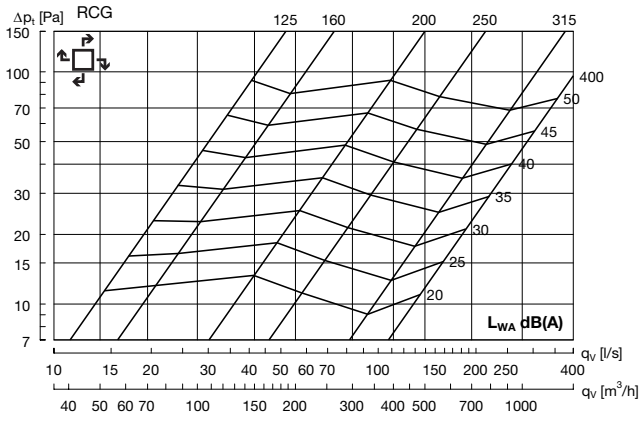

RCG 125 + MBB - Supply air

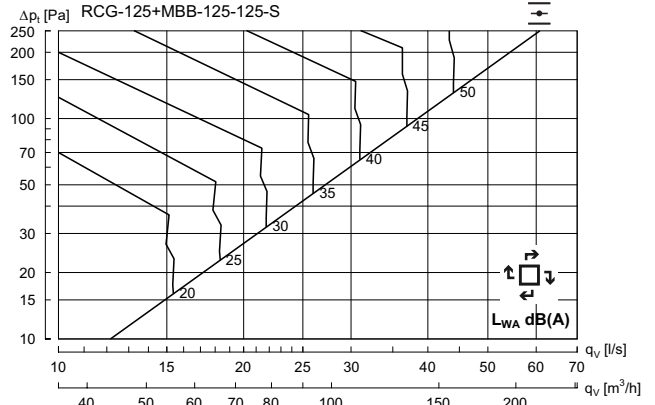

Hz	63	125	250	500	1K	2K	4K	8K
K_{ok}	14	5	2	-3	-7	-10	-20	-31

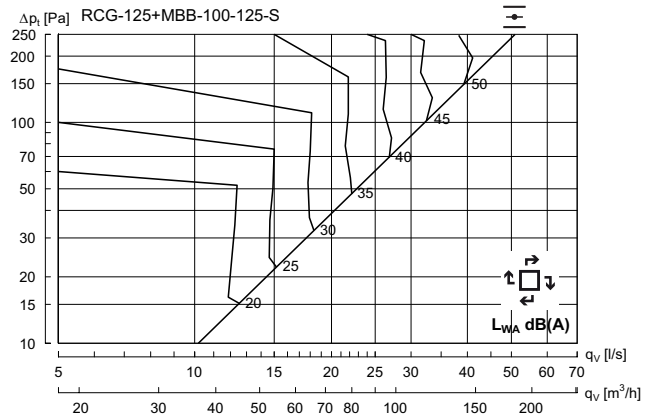

Hz	63	125	250	500	1K	2K	4K	8K
K_{ok}	9	4	4	-3	-7	-11	-22	-33

Swirl diffuser

RCG

Technical data

RCG 160 + MBB - Supply air

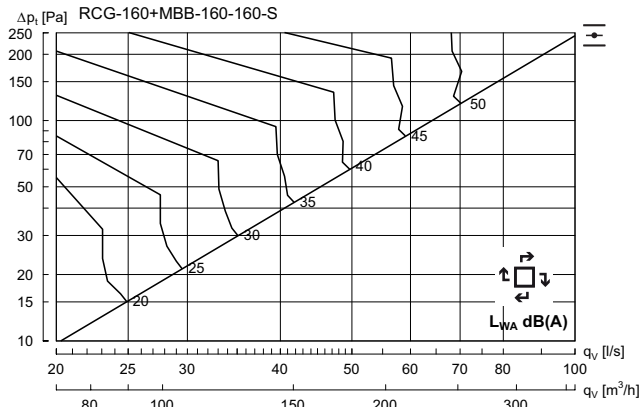

Hz	63	125	250	500	1K	2K	4K	8K
K_{ok}	5	7	3	-2	-7	-11	-22	-34

RCG 200 + MBB - Supply air

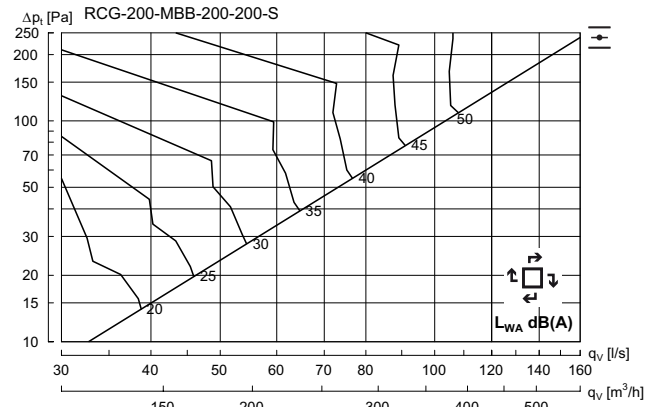

Hz	63	125	250	500	1K	2K	4K	8K
K_{ok}	14	7	2	-2	-6	-13	-24	-35

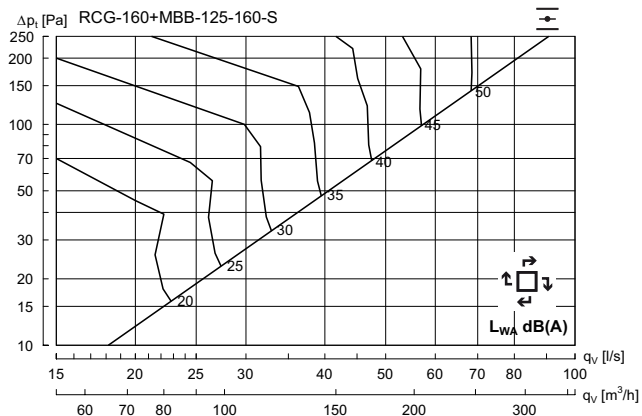

Hz	63	125	250	500	1K	2K	4K	8K
K_{ok}	8	5	4	-3	-7	-12	-22	-34

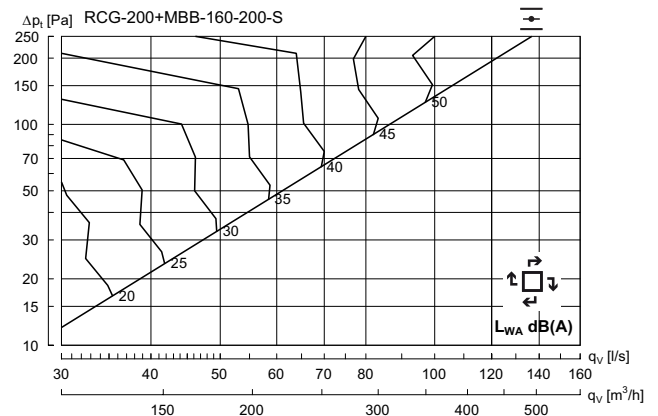

Hz	63	125	250	500	1K	2K	4K	8K
K_{ok}	11	7	3	-3	-7	-12	-22	-34

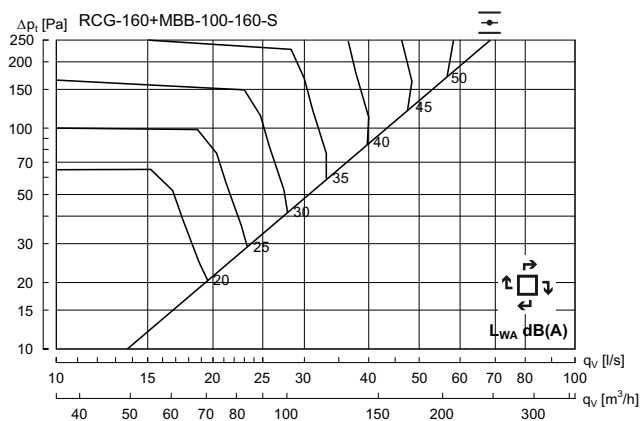

Hz	63	125	250	500	1K	2K	4K	8K
K_{ok}	12	4	4	-3	-7	-12	-20	-27

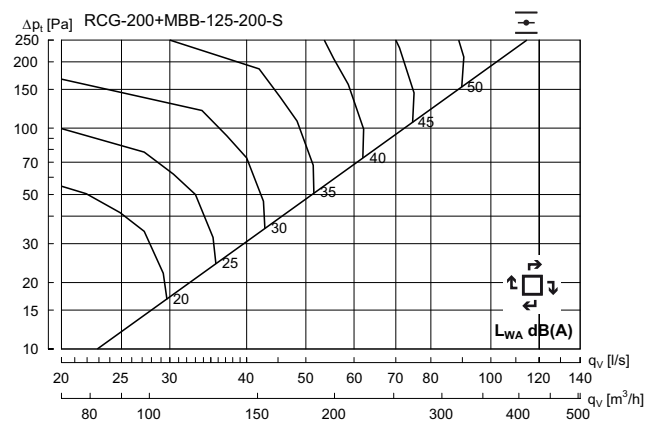

Hz	63	125	250	500	1K	2K	4K	8K
K_{ok}	10	5	5	-4	-8	-12	-18	-27

Swirl diffuser

RCG

Technical data

RCG 250 + MBB - Supply air

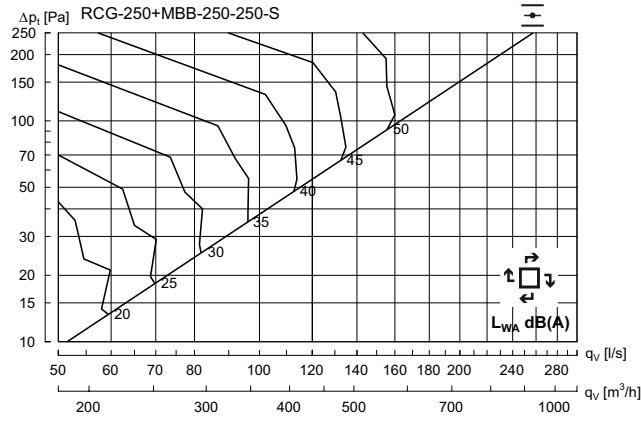

Hz	63	125	250	500	1K	2K	4K	8K
K_{ok}	10	6	2	-3	-5	-12	-21	-29

RCG 315 + MBB - Supply air

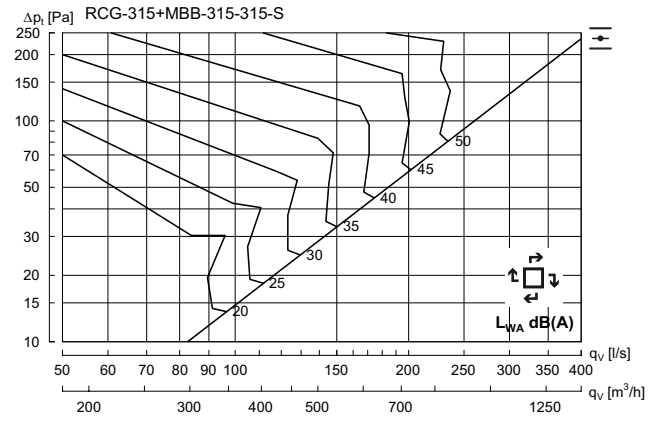

Hz	63	125	250	500	1K	2K	4K	8K
K_{ok}	12	4	2	-3	-4	-14	-22	-32

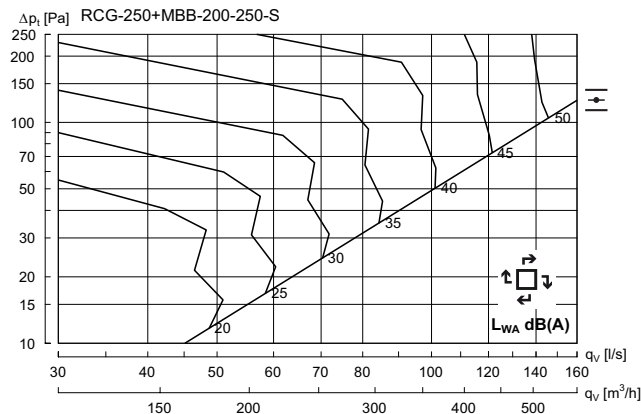

Hz	63	125	250	500	1K	2K	4K	8K
K_{ok}	8	7	3	-2	-6	-12	-22	-34

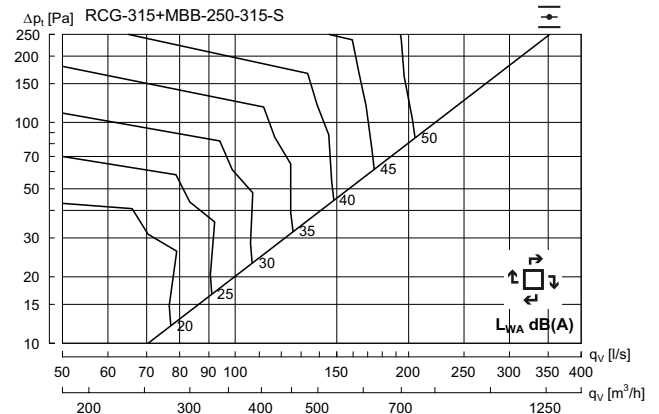

Hz	63	125	250	500	1K	2K	4K	8K
K_{ok}	10	7	3	-3	-6	-14	-22	-32

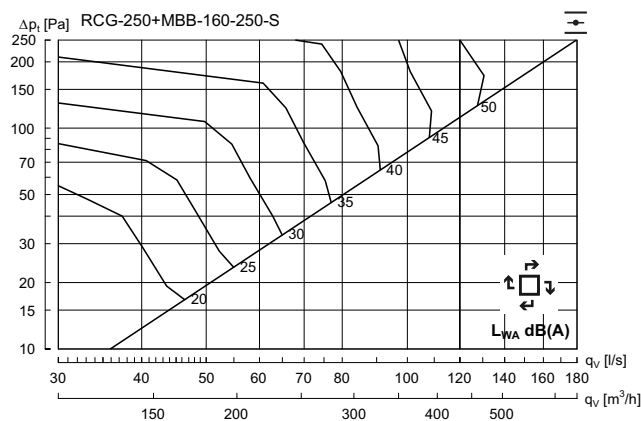

Hz	63	125	250	500	1K	2K	4K	8K
K_{ok}	12	6	3	-3	-7	-12	-20	-29

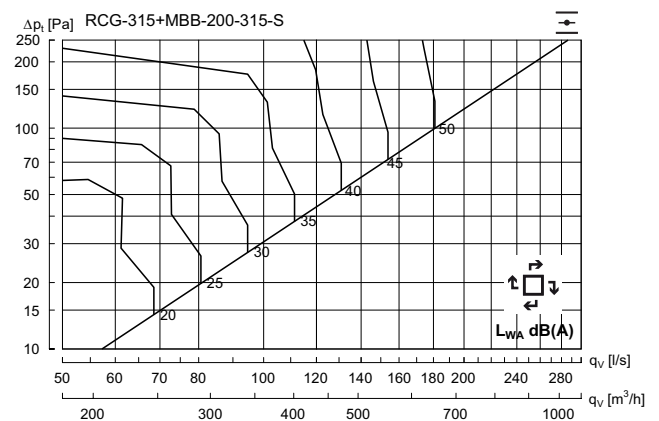

Hz	63	125	250	500	1K	2K	4K	8K
K_{ok}	9	7	3	-2	-6	-13	-22	-31

Swirl diffuser

RCG

Technical data

RCG 400 + MBB - Supply air

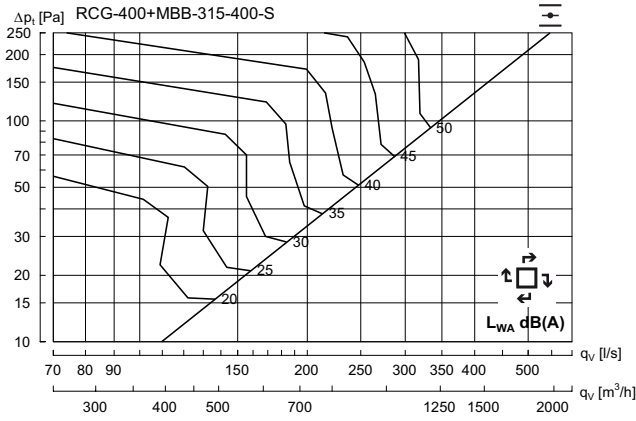

Hz	63	125	250	500	1K	2K	4K	8K
K_{ok}	10	5	2	-4	-5	-11	-20	-28

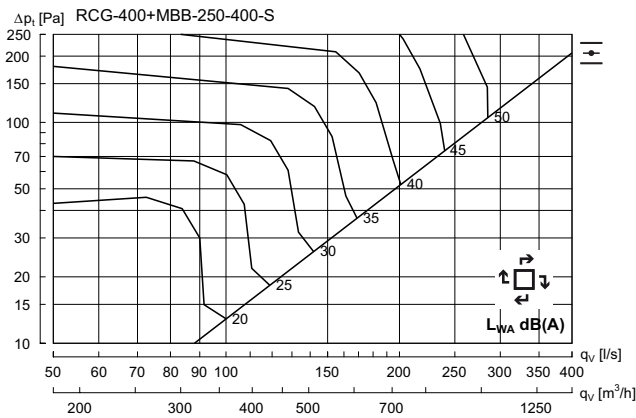

Hz	63	125	250	500	1K	2K	4K	8K
K_{ok}	9	6	2	-3	-5	-11	-19	-28

- 1
- 2
- 3
- 4
- 5
- 6
- 7
- 8
- 9
- 10
- 11
- 12
- 13
- 14
- 15
- 16
- 17
- 18

Plain diffuser

LCC



Dimensions

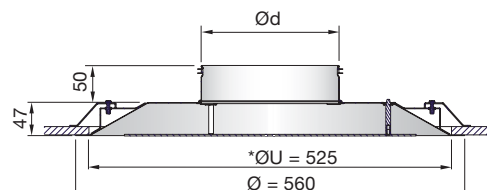

*ØU = Ceiling grid opening = 525 mm, all sizes.

LCC Ød mm	Weight kg
125	1.25
160	1.50
200	2.30
250	3.40
315	4.60

Description

LCC is a flush mounted circular diffuser with a circular unperforated face plate for installation in ceiling systems and permanent ceilings. LCC can be used for both supply and exhaust air. LCC is suitable for horizontal supply of cooled air and has a large dynamic range. Installing an LCC diffuser in a plenum box type MBB can help to achieve a stable airflow to the diffuser as well as realise the potential for individual adjustment.

- Simple and aesthetic appearance
- Large dynamic range
- Can be used for both supply and exhaust air

Maintenance

The faceplate can be removed to enable cleaning of internal parts or to gain access to the plenum box. The visible parts of the diffuser can be wiped with a damp cloth.

Technical data

For full documentation including Quick selection, sound diagrams, and K_{ok} -values, see LCP in the Integra chapter.

Ød = 125-250 => LCC has mounting holes for MBB

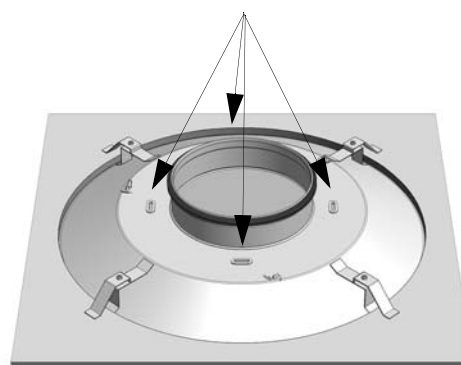

Ød = 315 => LCC has no mounting holes for MBB !

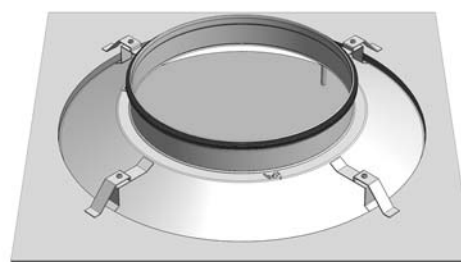

Brackets included for LCC, for details, see the Integra installation instruction.

Order code

Product	LCC	aaa
Type	LCC	
Connection dim.	Ød 125-315	

Example: LCC-160

Materials and finish

Upper part:	Galvanised steel
Face plate:	Aluminium
Face plate finish:	Powder coated
Standard colour:	RAL 9010, gloss 30

Other colours are available. Please contact Lindab's sales department for further information.

Plain diffuser

LKP/LCP



LKP

Description

LCP is a flush-mounted square diffuser with a circular unperforated face plate for installation in ceiling systems. LCP can be used for both supply and exhaust air. LCP is suitable for the horizontal supply of cooled air and has a large dynamic range. Installing an LCP diffuser in a plenum box type MBB can help to achieve a stable airflow to the diffuser as well as realise the potential for individual adjustment. LKP has a square face plate and the same properties as LCP.

- Simple and stylish appearance
- Large dynamic range
- Can be used for both supply and exhaust air
- Can be adapted to most ceiling systems

Maintenance

The face plate can be removed to enable cleaning of internal parts or to gain access to the duct or box. The visible parts of the diffuser can be wiped with a damp cloth.

Order code

Product	LCP/LKP	aaa	b
Type	LCP/LKP		
Connection dim.	Ød 125-315		
Ceiling system	1 - 14		

Example: LCP-160-1



LCP

Dimensions

LKP

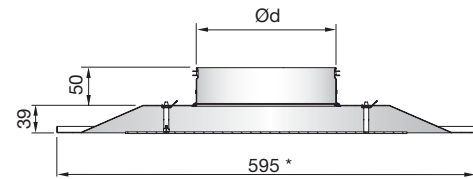

* ceiling system 1, other ceiling systems see Integra chapter page 122-123.

LCP

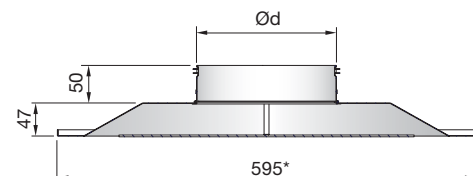

Ød = 315 => LCP has no mounting holes for MBB !

LKP/LCP Ød	Weight
mm	kg
125	3.2
160	3.2
200	3.3
250	3.4
315	3.5

Materials and finish

Grille box:	Galvanised steel
Face plate LKP:	Galvanised steel
Face plate LCP:	Aluminium
Face plate finish:	Powder-coated
Standard colour:	RAL 9010 Gloss 30

The diffuser is available in other colours. Please contact Lindab's sales department for further information.

Plain diffuser

LCC/LKP/LCP

Accessories

Plenum box

MBB



LKP + MBB

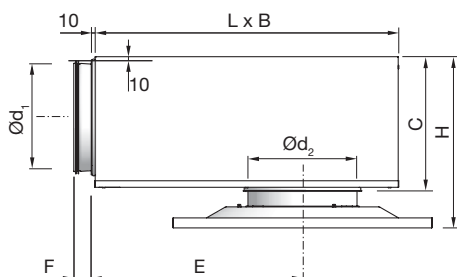

LKP + MBB		B mm	C mm	E mm	F mm	H* mm	L mm
duct Ød ₁ mm	LKP Ød ₂ mm						
100	125	260	159	216	50	198 - 238	310
100	160	260	159	216	50	198 - 238	310
125	125	310	184	262	50	223 - 263	376
125	160	310	184	262	50	223 - 263	376
125	200	310	184	262	50	223 - 263	376
160	160	380	220	323	50	257 - 297	459
160	200	380	220	323	50	257 - 297	459
160	250	380	220	323	50	257 - 297	459
200	200	460	259	396	70	298 - 338	565
200	250	460	259	396	70	298 - 338	565
200	315	460	259	396	70	298 - 338	565
250	250	540	309	486	70	348 - 388	698
250	315	540	309	486	70	348 - 388	698
315	315	540	373	648	70	413 - 453	858

* Using accessory MBZ the H dimension will increase:
 Ød₂ = 125 - 200 mm => H +40 mm
 Ød₂ = 250 - 315 mm => H +60 mm

Order code

Product **MBB** - **aaa** - **bbb** - **c**

Type

MBB

Duct connection Ød₁

Ø100-315

Diffuser dimension Ød₂

Ø125-315

Functional use

S = Supply air
 E = Exhaust

Example: LCP-160-1+MBB-160-160-S

Accessories

LCC + MBB

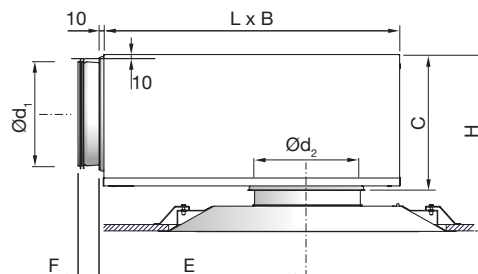

LCP + MBB

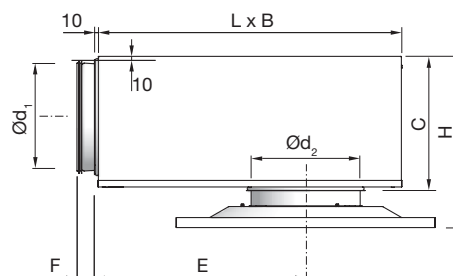

LCC / LCP + MBB		B mm	C mm	E mm	F mm	H* mm	L mm
duct Ød ₁ mm	LCP Ød ₂ mm						
100	125	260	159	216	50	206 - 246	310
100	160	260	159	216	50	206 - 246	310
125	125	310	184	262	50	231 - 271	376
125	160	310	184	262	50	231 - 271	376
125	200	310	184	262	50	231 - 271	376
160	160	380	220	323	50	265 - 305	459
160	200	380	220	323	50	265 - 305	459
160	250	380	220	323	50	265 - 305	459
200	200	460	259	396	70	306 - 346	565
200	250	460	259	396	70	306 - 346	565
200	315	460	259	396	70	306 - 346	565
250	250	540	309	486	70	356 - 396	698
250	315	540	309	486	70	356 - 396	698
315	315	540	373	646	70	421 - 461	858

* Using accessory MBZ the H dimension will increase:
 Ød₂ = 125 - 200 mm => H +40 mm
 Ød₂ = 250 - 315 mm => H +60 mm

Plain diffuser

LCC/LKP/LCP

Technical data

Capacity

Air flow q_v [l/s] and [m³/h], total pressure Δp_t [Pa], throw $l_{0,2}$ [m] and sound power level L_{WA} [dB(A)] can be seen in the diagrams.

Frequency-related sound effect level

The sound effect level in the frequency band is defined as $L_{WA} + K_{ok}$. K_{ok} values are specified in charts beneath the diagrams on the following pages.

Quick selection, supply air

LCC/LKP/LCP + MBB		$\Delta p_t \geq 50$ Pa		$\Delta p_t \geq 50$ Pa	
duct	LKP/LCP	30 dB(A)		35 dB(A)	
$\varnothing d_1$	$\varnothing d_2$	l/s	m ³ /h	l/s	m ³ /h
100	125	37	133	44	158
100	160	39	140	48	173
125	125	48	173	56	202
125	160	56	202	66	238
125	200	61	220	73	263
160	160	67	241	85	306
160	200	79	284	99	356
160	250	95	342	113	407
200	200	92	331	117	421
200	250	105	378	122	439
200	315	118	425	145	522
250	250	112	403	132	475
250	315	131	472	168	605
315	315	144	518	169	608

Throw $l_{0,2}$

Throw $l_{0,2}$ [m] can be seen in the diagram for isothermal air, at a terminal velocity of 0.2 m/s.

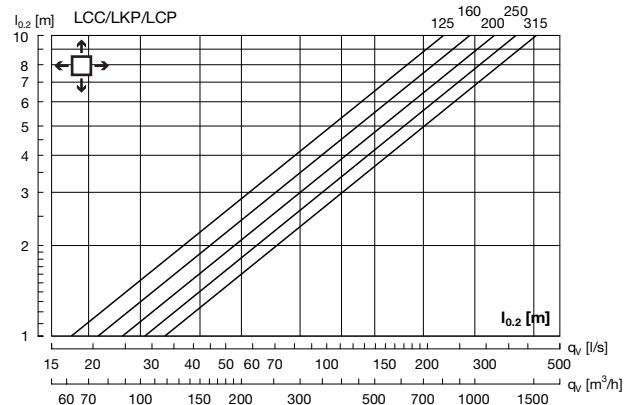

Sound attenuation

Sound attenuation of the diffusers ΔL from duct to room, including end reflection, see table below.

LCC/LCP/LKP + MBB		Centre frequency Hz							
duct	LCC/LCP/LKP	63	125	250	500	1K	2K	4K	8K
$\varnothing d_1$	$\varnothing d_2$								
100	125	17	15	10	17	15	18	19	21
100	160	17	16	6	10	18	18	18	21
125	125	17	15	10	17	15	18	19	21
125	160	15	14	10	17	16	17	18	21
125	200	13	12	7	13	13	16	17	18
160	160	17	15	12	21	19	19	21	21
160	200	17	16	10	20	17	17	19	20
160	250	16	14	7	17	15	16	19	20
200	200	13	11	10	17	18	15	19	18
200	250	14	11	8	15	19	15	18	17
200	315	14	9	7	13	18	14	17	17
250	250	15	10	9	17	18	18	19	19
250	315	15	8	9	16	18	16	18	18
315	315	8	10	10	17	18	17	18	24

Balancing

Balancing data is contained in a separate brochure.

Plain diffuser

LCC/LKP/LCP

Technical data

LCC/LKP/LCP without box – supply air

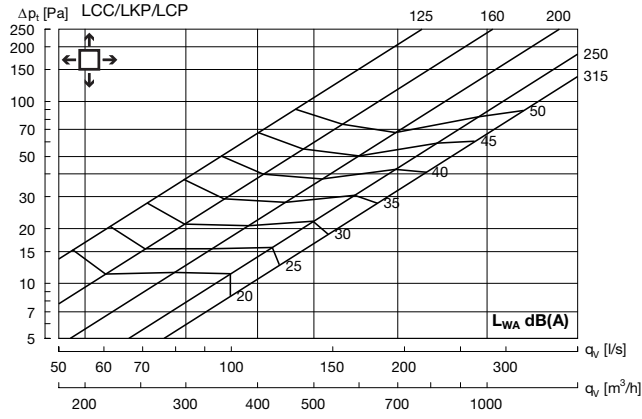

LCC/LKP/LCP 125 + MBB - Supply air

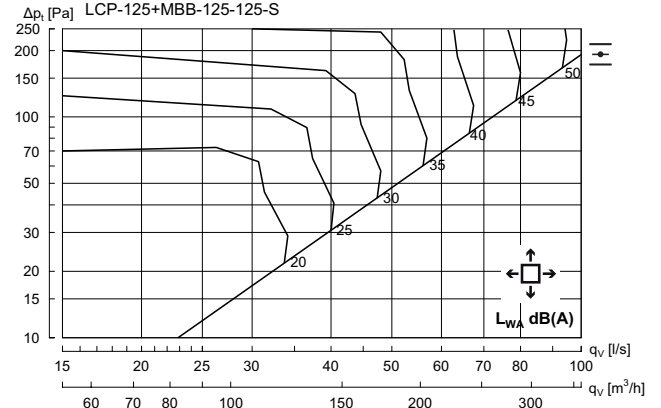

Hz	63	125	250	500	1K	2K	4K	8K
K _{ok}	13	7	1	-2	-6	-14	-20	-25

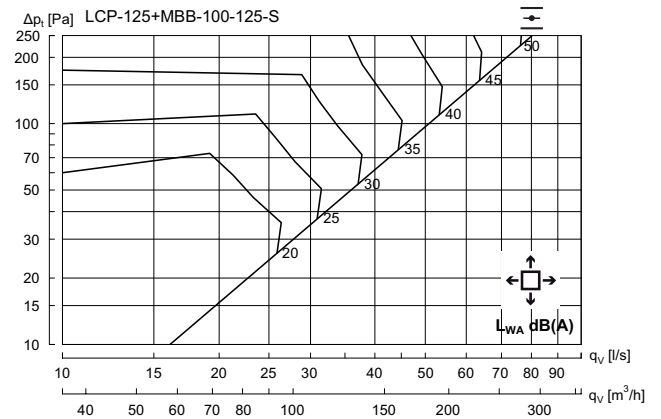

Hz	63	125	250	500	1K	2K	4K	8K
K _{ok}	10	4	2	-2	-6	-10	-17	-23

Plain diffuser

LCC/LKP/LCP

Technical data

LCC/LKP/LCP 160 + MBB - Supply air

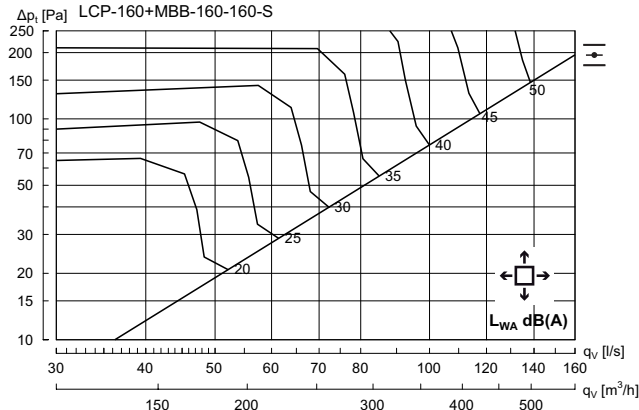

Hz	63	125	250	500	1K	2K	4K	8K
K_{ok}	13	8	0	-3	-6	-10	-19	-25

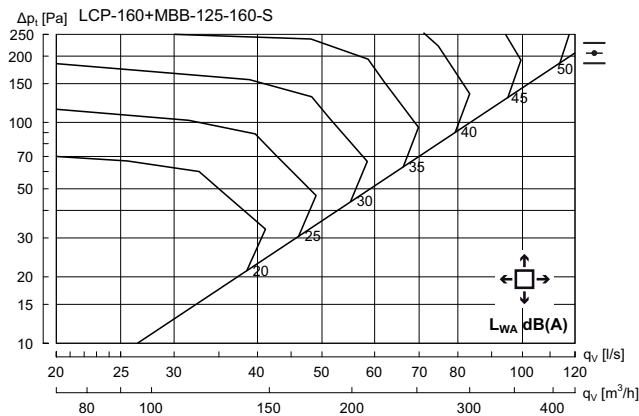

Hz	63	125	250	500	1K	2K	4K	8K
K_{ok}	9	8	1	-3	-6	-11	-16	-22

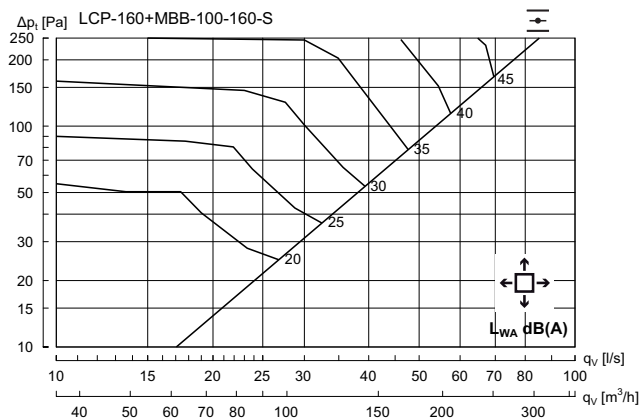

Hz	63	125	250	500	1K	2K	4K	8K
K_{ok}	9	5	0	-1	-7	-10	-16	-21

LCC/LKP/LCP 200 + MBB - Supply air

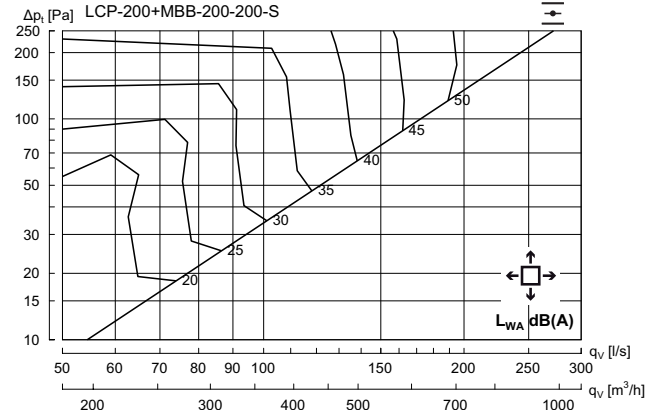

Hz	63	125	250	500	1K	2K	4K	8K
K_{ok}	12	8	0	-3	-5	-14	-21	-24

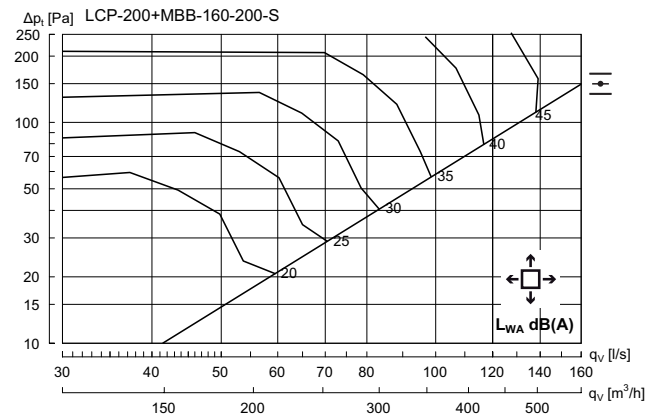

Hz	63	125	250	500	1K	2K	4K	8K
K_{ok}	12	7	-1	-3	-5	-10	-15	-21

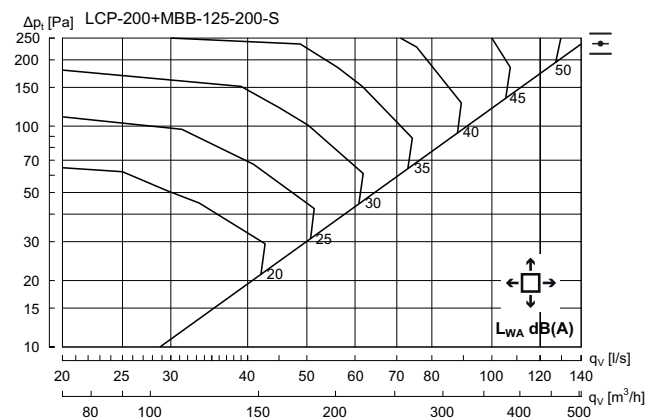

Hz	63	125	250	500	1K	2K	4K	8K
K_{ok}	6	6	0	-3	-5	-9	-16	-21

Plain diffuser

LCC/LKP/LCP

Technical data

LCC/LKP/LCP 250 + MBB - Supply air

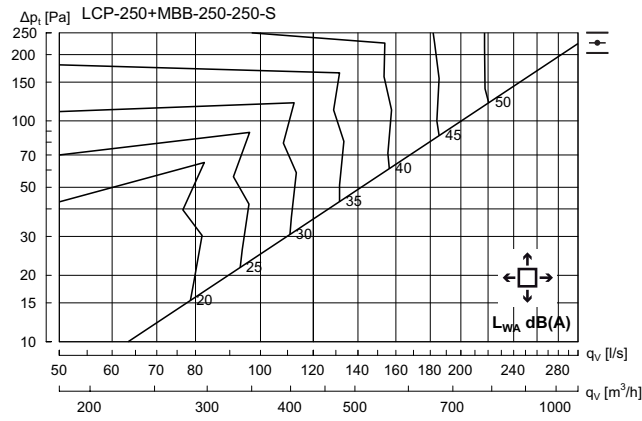

Hz	63	125	250	500	1K	2K	4K	8K
K_{ok}	15	6	-1	-1	-5	-15	-23	-29

LCC/LKP/LCP 315 + MBB - Supply air

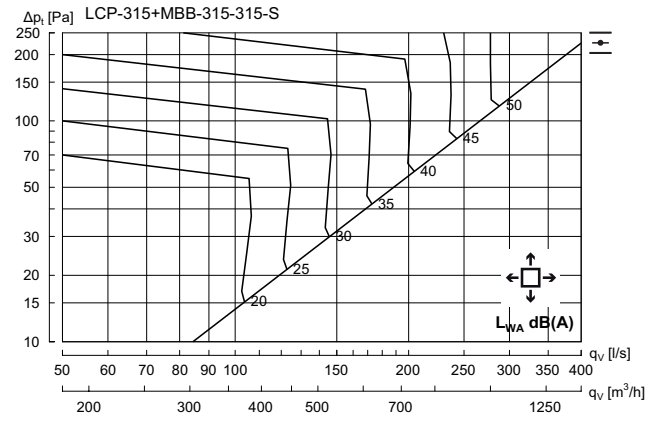

Hz	63	125	250	500	1K	2K	4K	8K
K_{ok}	12	4	0	-2	-4	-14	-19	-27

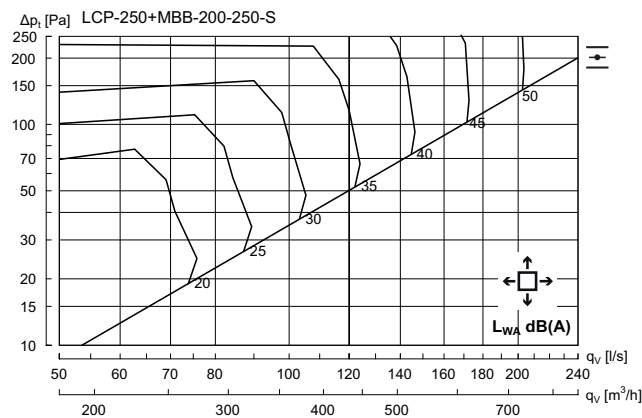

Hz	63	125	250	500	1K	2K	4K	8K
K_{ok}	13	8	-1	-2	-5	-13	-20	-26

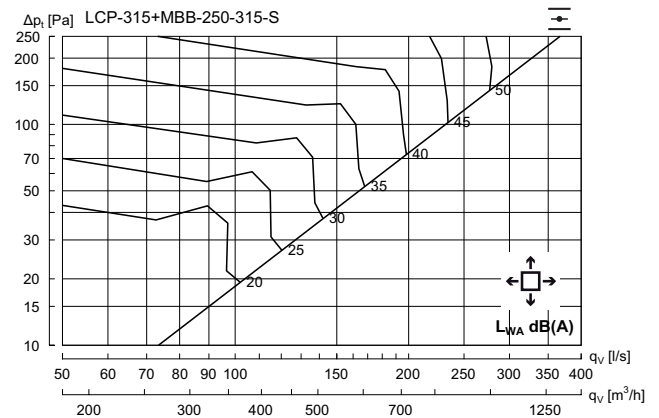

Hz	63	125	250	500	1K	2K	4K	8K
K_{ok}	13	7	0	-2	-6	-10	-17	-23

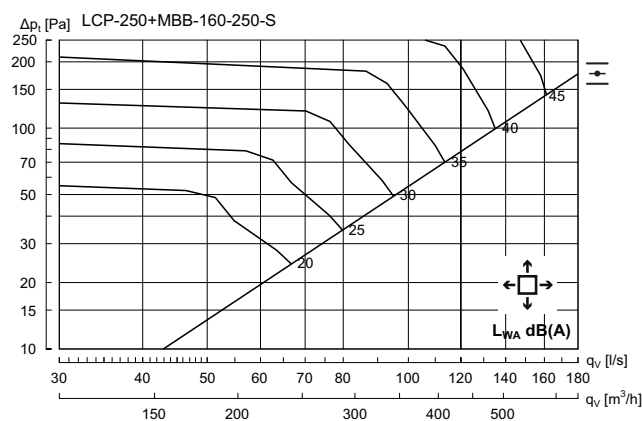

Hz	63	125	250	500	1K	2K	4K	8K
K_{ok}	13	7	0	-4	-5	-11	-16	-22

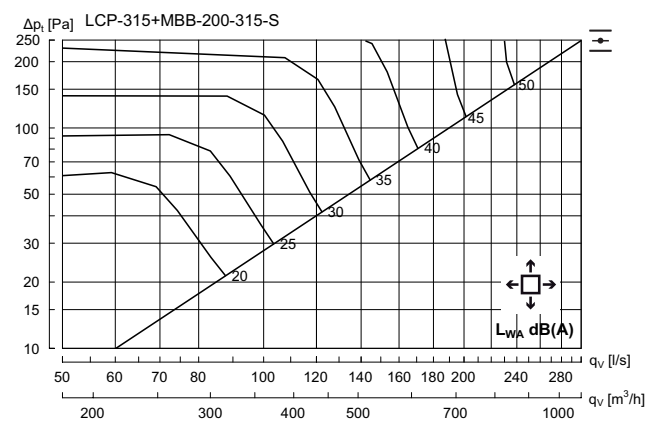

Hz	63	125	250	500	1K	2K	4K	8K
K_{ok}	12	10	0	-3	-6	-12	-19	-24

Plain diffuser

LCC/LKP/LCP

Technical data

LCC/LKP/LCP without box – Exhaust

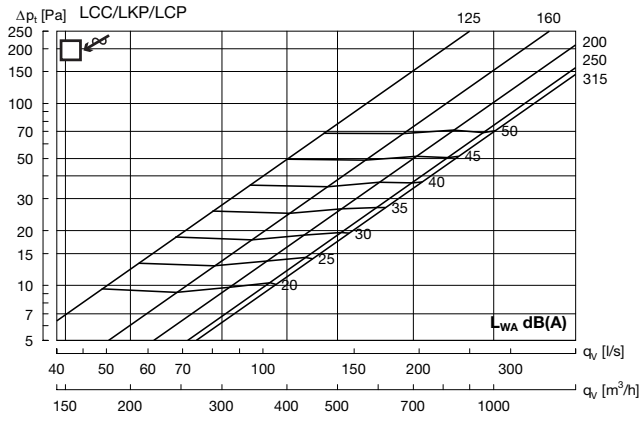

LCC/LKP/LCP 125 + MBB - Exhaust air

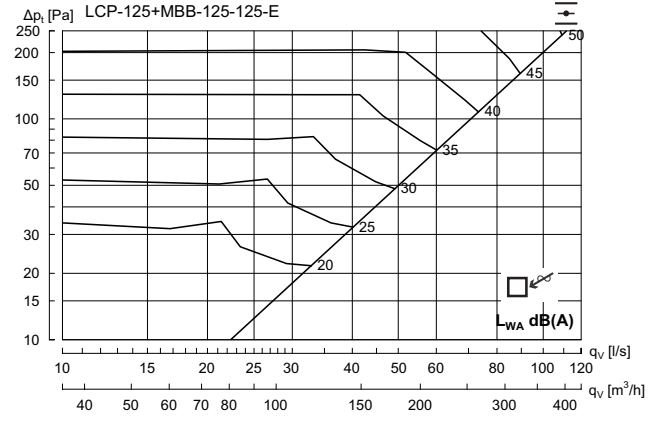

Hz	63	125	250	500	1K	2K	4K	8K
K _{0k}	12	4	-1	-1	-6	-12	-16	-22

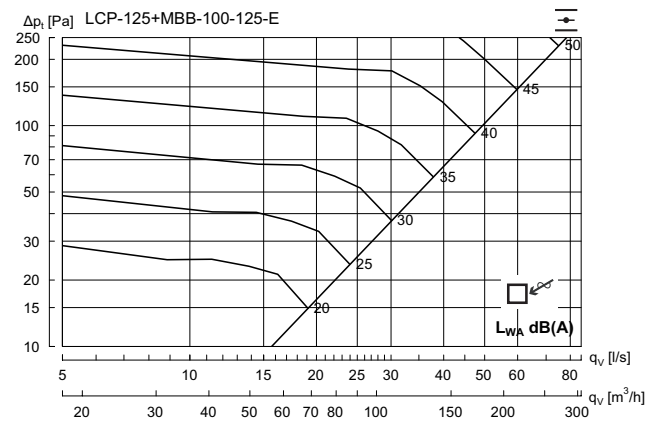

Hz	63	125	250	500	1K	2K	4K	8K
K _{0k}	13	-1	3	-1	-9	-11	-17	-23

- 1
- 2
- 3
- 4
- 5
- 6
- 7
- 8
- 9
- 10
- 11
- 12
- 13
- 14
- 15
- 16
- 17
- 18

Plain diffuser

LCC/LKP/LCP

Technical data

LCC/LKP/LCP 160 + MBB - Exhaust air

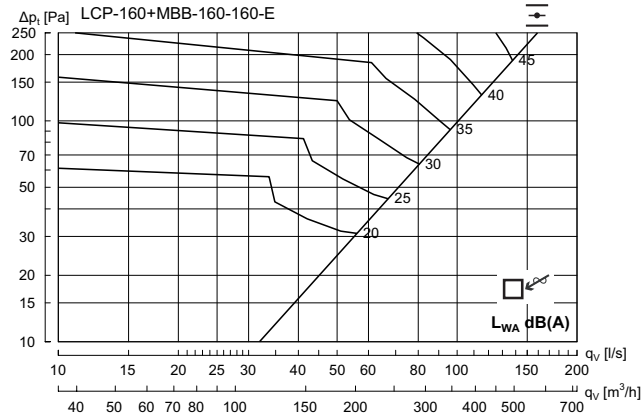

Hz	63	125	250	500	1K	2K	4K	8K
K_{ok}	16	4	-1	-2	-5	-10	-16	-21

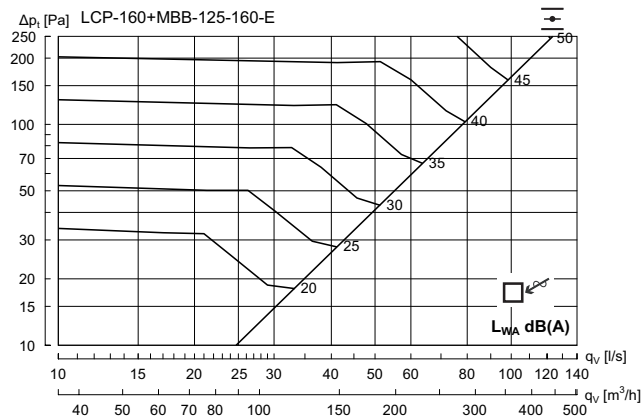

Hz	63	125	250	500	1K	2K	4K	8K
K_{ok}	14	5	0	-1	-6	-11	-15	-21

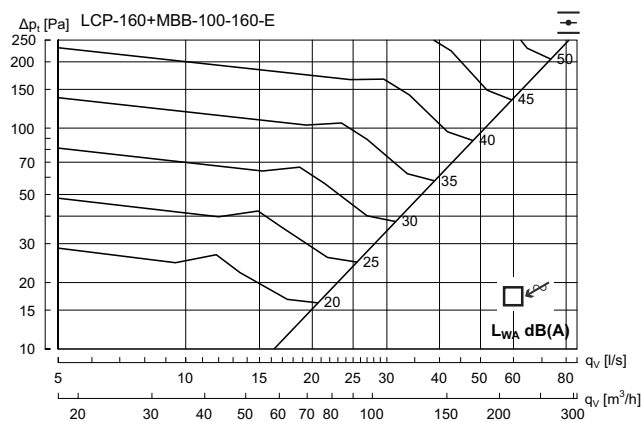

Hz	63	125	250	500	1K	2K	4K	8K
K_{ok}	11	3	2	0	-8	-13	-17	-23

LCC/LKP/LCP 200 + MBB - Exhaust air

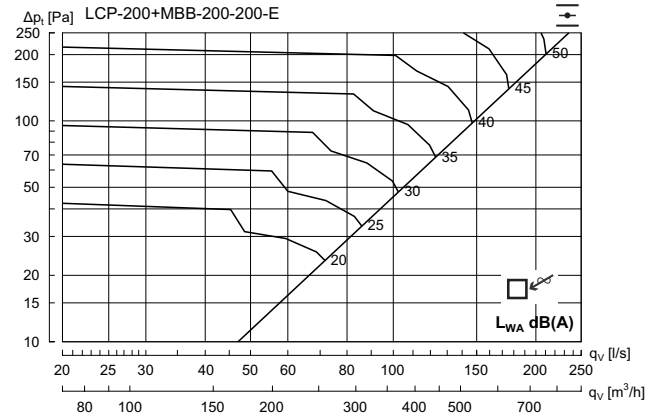

Hz	63	125	250	500	1K	2K	4K	8K
K_{ok}	15	5	0	-2	-6	-10	-15	-23

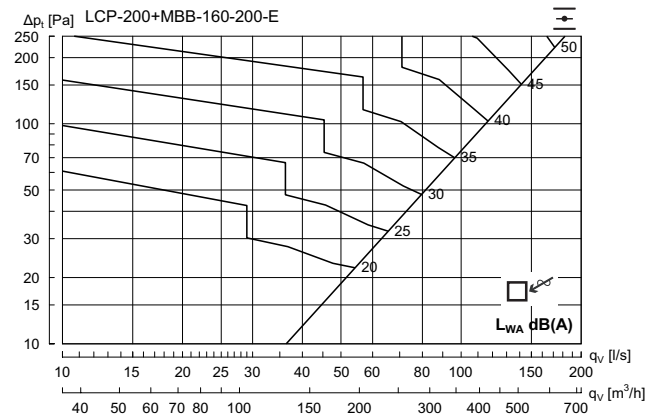

Hz	63	125	250	500	1K	2K	4K	8K
K_{ok}	16	5	-1	-3	-5	-10	-15	-21

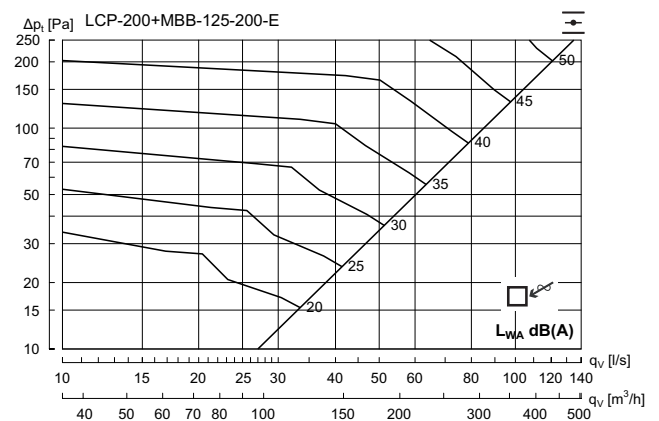

Hz	63	125	250	500	1K	2K	4K	8K
K_{ok}	11	3	-1	-2	-5	-10	-16	-22

Plain diffuser

LCC/LKP/LCP

Technical data

LCC/LKP/LCP 250 + MBB - Exhaust air

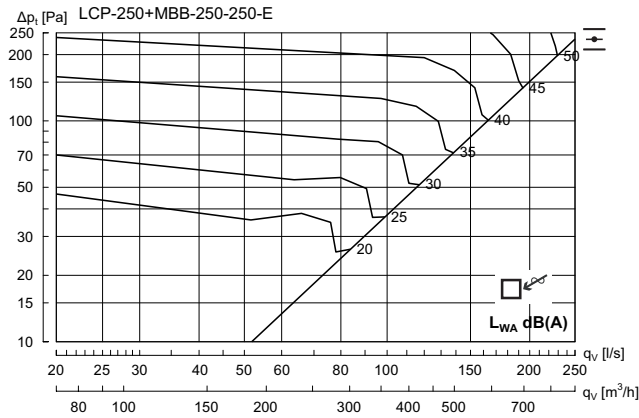

Hz	63	125	250	500	1K	2K	4K	8K
K_{ok}	11	4	1	-2	-5	-11	-17	-25

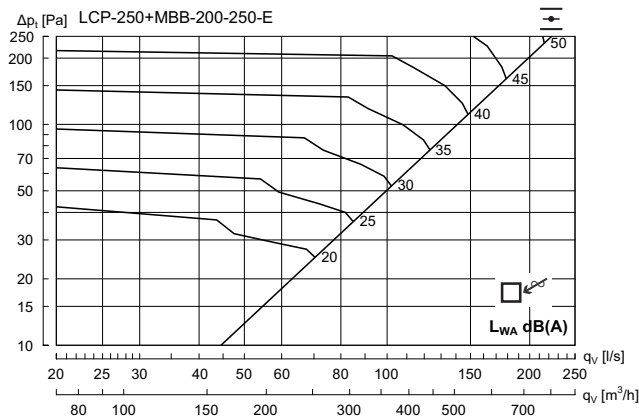

Hz	63	125	250	500	1K	2K	4K	8K
K_{ok}	14	4	0	-2	-6	-11	-16	-25

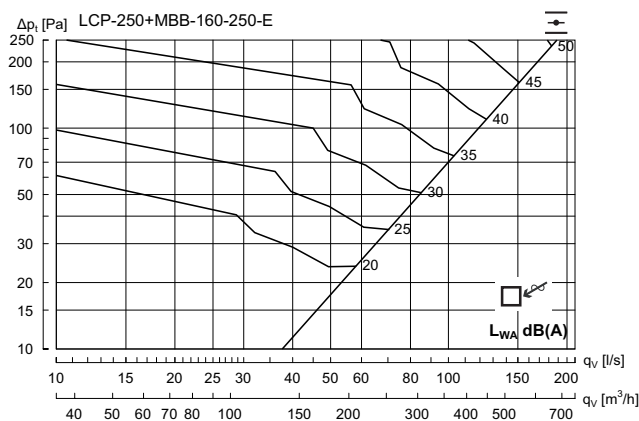

Hz	63	125	250	500	1K	2K	4K	8K
K_{ok}	19	6	-1	-4	-5	-12	-18	-26

LCC/LKP/LCP 315 + MBB - Exhaust air

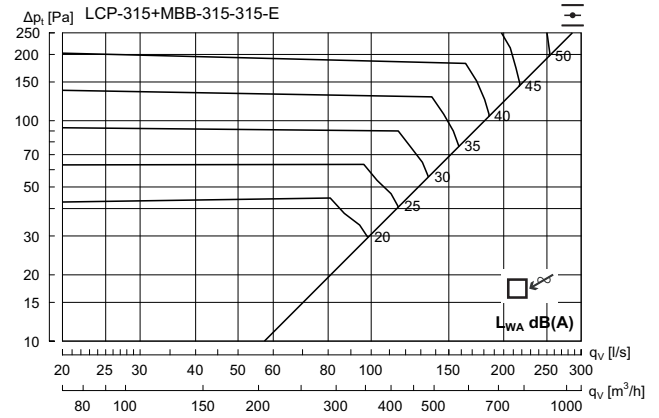

Hz	63	125	250	500	1K	2K	4K	8K
K_{ok}	12	4	2	-3	-6	-9	-18	-27

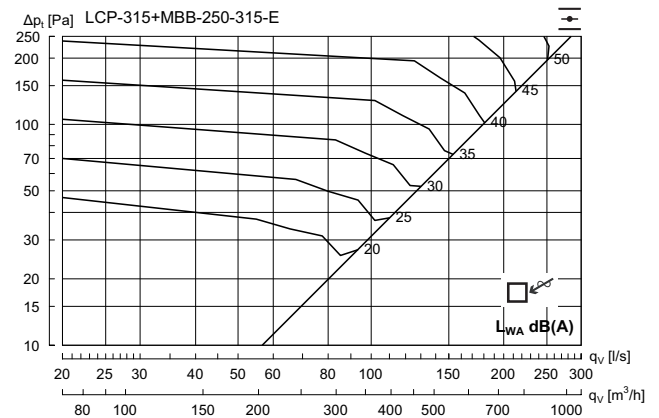

Hz	63	125	250	500	1K	2K	4K	8K
K_{ok}	12	5	2	-3	-6	-10	-17	-24

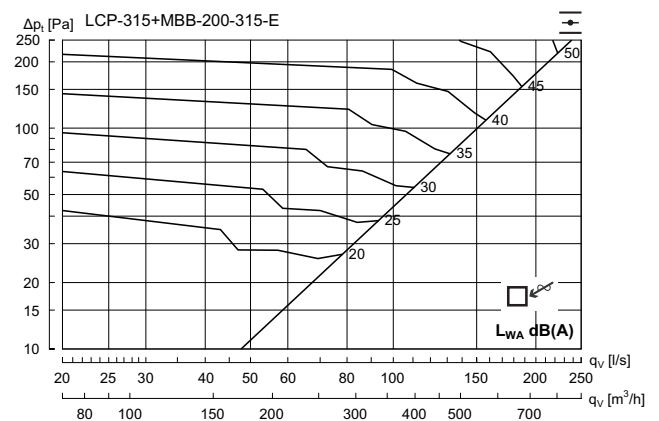

Hz	63	125	250	500	1K	2K	4K	8K
K_{ok}	14	5	0	-3	-5	-10	-16	-25

Lindab Versio











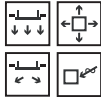

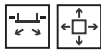

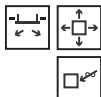
- 1
- 2
- 3
- 4
- 5
- 6
- 7
- 8
- 9
- 10
- 11
- 12
- 13
- 14
- 15
- 16
- 17
- 18

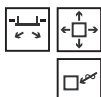
RS14, adjusted ceiling type Markant.

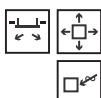
Lindab Versio a series of ceiling adapted diffusers

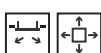
Diffusers for mixed ventilation

Diffusers	Product	Functions	Page
	PS1		195
	PS8		205
	RS14		213
	RS15		227
	RS16		239
	NS19		247
	GS23		255



NS19-H.



NS19-V.

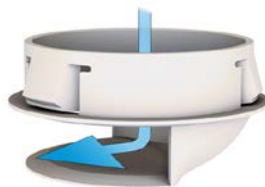

NS19-R.



NS19-V+MBB.

Lindab Versio

a series of ceiling adapted diffusers



CMC Biopharmaceuticals AVS, Søborg.

Lindab Versio

Lindab Versio is a series of square ceiling diffusers for supply and exhaust air adapted for false ceilings.

Versio is, as the name implies, a variety of possibilities to construct the diffuser to suit the specific need. A large selection of face plates with different designs meet requirements for both design and function. Different types of plenum boxes ensure the possibility to connect the diffuser to the duct system, and at the same time regulate the diffusers individually.

Versio can be adapted to most ceiling systems, so the diffuser will blend in naturally with the ceiling environment, and ensure a simple mounting, which will make the job easier when mounting the diffuser directly at the construction site.

Unique flexibility

Versio gives a unique freedom of selection and flexibility. The final configured diffuser is simple to mount and is delivered finished and adapted to the individual ceiling system.



NS19 with plenum box type H.

Lindab Versio

a series of ceiling adapted diffusers

Design

See [Comfort and Design](#)



Ventilation principle

Size

Product

Plenum boxes

Details, see chapter [Plenum boxes](#)

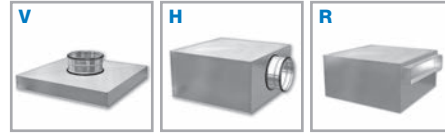

H = 95 mm

H = Ød + 90 mm

H = 170 mm

Dimension
A x B
(Only R box)

	Perforated	Perforated rotation	Swirl	Nozzles	Grid		
PS	No.: 1 125 160 200 250 315	No.: 2 No.: 3 No.: 4 125 160 200 250 315	No.: 8 125 160 200 250 315	No.: 9 No.: 10 No.: 11 125 160 200 250 315	No.: 14 125 160 200 250 315	No.: 15 125 160 200 250 315	No.: 16 125 160 200 250 315
	200 x 100 300 x 100 400 x 100 500 x 100	200 x 100 300 x 100 400 x 100 500 x 100	200 x 100 300 x 100 400 x 100 500 x 100	200 x 100 300 x 100 400 x 100 500 x 100	200 x 100 300 x 100 400 x 100 500 x 100	200 x 100 300 x 100 400 x 100 500 x 100	
	 H = 95 mm	 H = Ød + 90 mm	 H = 170 mm	 H = 95 mm	 H = Ød + 90 mm	 H = 170 mm	
	No.: 19 125 160 200 250 315	No.: 23 125 160 200 250 315	200 x 100 300 x 100 400 x 100 500 x 100	200 x 100 300 x 100 400 x 100 500 x 100	200 x 100 300 x 100 400 x 100 500 x 100	200 x 100 300 x 100 400 x 100 500 x 100	

Lindab Versio a series of ceiling adapted diffusers

Regulation Accessories

See product pages

Type	Size	Patterns	1	2	MDR (PS1-4)	PBB	MHS	MBB
Grille box	mm							
V	 160 200 250 315	300 400 500 600			● ● ●	● ● ● ●	● ● ● ●	● ● ● ●
Plenum box	mm							
H	 125 160 200 250 315	300 400 500 600 600	● ● ● ● ●	● ● ● ● ●	● ● ●	● ● ● ● ●	● ● ● ● ●	
Rectangular connection	mm							
R	 200 300 400 500	300 400 500 600	○ ○ ○ ○	○ ○ ○ ○	● ● ● ●	● ● ● ●	● ● ● ●	

- 1. Product and tech. data depicted in catalogue.
- 2. Combination possible. Tech. data depicted in catalogue.
- 3. Combination possible. Tech. data not in catalogue.
- 4. If space is empty, combination is not possible.

Guide to diffuser selection

- 1 Lindab Versio starts with a product- and design choice based on function and design. Ex. : PS1 or RS14. The design is numbered, and specifically described in the chapter "Comfort and Design". Then a choice must be made of a grille box / plenum box depending on the type of connection, circular or rectangular, vertical or horizontal.
- 2 To obtain the desired function, one has to decide how the diffuser should be used: Supply (S), Exhaust (E), or Low-impulse(L). If the plenum box type H or R is chosen, it is necessary to know which type of regulation is required: without damper and measuring device (0), with damper without measuring device (1) or with damper and measuring device (2).
- 3 The connection dimension for the diffuser/plenum box is set, and finally the ceiling system is stated. The ceiling systems are numbered, and more specifically described in "Ceiling adaption".
- 4 Lindab Versio is ready to order after making the specific choices. The final configured product is named in the order. Ordering codes are also found on the product pages as well as in the rest of the product programme.

Example of ordering Versio + grille box/plenum box

In this example the order is for:
Square diffuser with non-adjustable swirl pattern. Integrated side-connected plenum box with connection dimension ø200. The diffuser should be supplied with damper and measuring device for individual regulation of the unit. The diffuser should be adapted to T24 600x600 system ceiling in a cleanable design.



Lindab Versio

a series of ceiling adapted diffusers

Design

See [Comfort and Design](#)



Product

Ceiling tile adaption

Details, see chapter [Ceiling tile adaption](#)

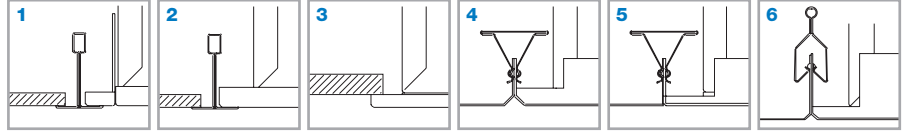

1 Danotile T24/T15
Ecophon T24
Rockfon A24.

2 Danotile T24/T15
Ecophon T24
Rockfon A24

3 Permanent ceiling

4 Dampa Clip-In
Bevelled edge

5 Dampa Clip-In
Square edge

6 Luxalon Clip-In

Grille box/plenum boxes

	Perforated	mm	V H R V H R V H R V H R V H R									
			125		160		200		250		315	
PS	No.: 1 No.: 2 No.: 3 No.: 4		125		160		200		250		315	
			125		160		200		250		315	
			125		160		200		250		315	
			125		160		200		250		315	
	Perforated rotation No.: 8 No.: 9 No.: 10 No.: 11		125		160		200		250		315	
			125		160		200		250		315	
			125		160		200		250		315	
			125		160		200		250		315	
RS	Swirl No.: 14 No.: 15 No.: 16		125		160		200		250		315	
			125		160		200		250		315	
			125		160		200		250		315	
			125		160		200		250		315	
NS	Nozzles No.: 19		125		160		200		250		315	
			125		160		200		250		315	
			125		160		200		250		315	
			125		160		200		250		315	
GS	Grid No.: 23		125		160		200		250		315	
			125		160		200		250		315	
			125		160		200		250		315	
			125		160		200		250		315	

Lindab Versio a series of ceiling adapted diffusers

Design

See [Comfort and Design](#)



Product

Ceiling tile adaption

Details, see chapter [Ceiling tile adaption](#)

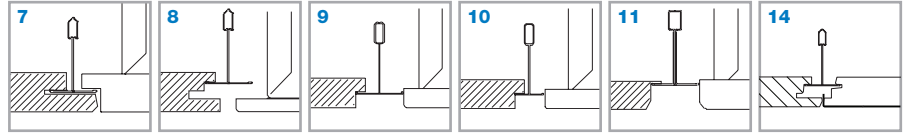

7	8	9	10	11	14
Danotile Contur Ecophon D Rockfon D-XL	Ecophon Focus DG	Rockfon E10 24 Ecophon - E / T24	Rockfon E10 15 Ecophon - E / T15	Danotile Markant	Ecophone Focus edge DS

Grille box/plenum boxes

		mm	V	H	R	V	H	R	V	H	R	V	H	R	V	H	R	V	H	R		
PS	Perforated	No.: 1	125	•	•	•	•	•	•	•	•	•	•	•	•	•	•	•	•	•	•	
			160	•	•	•	•	•	•	•	•	•	•	•	•	•	•	•	•	•	•	•
			200	•	•	•	•	•	•	•	•	•	•	•	•	•	•	•	•	•	•	•
		250	•	•	•	•	•	•	•	•	•	•	•	•	•	•	•	•	•	•	•	•
		315	•	•	•	•	•	•	•	•	•	•	•	•	•	•	•	•	•	•	•	•
			No.: 3	125	•	•	•	•	•	•	•	•	•	•	•	•	•	•	•	•	•	•
			No.: 4	160	•	•	•	•	•	•	•	•	•	•	•	•	•	•	•	•	•	•
				200	•	•	•	•	•	•	•	•	•	•	•	•	•	•	•	•	•	•
				250	•	•	•	•	•	•	•	•	•	•	•	•	•	•	•	•	•	•
				315	•	•	•	•	•	•	•	•	•	•	•	•	•	•	•	•	•	•
	Perforated rotation	No.: 8	125	•	•	•	•	•	•	•	•	•	•	•	•	•	•	•	•	•	•	
			160	•	•	•	•	•	•	•	•	•	•	•	•	•	•	•	•	•	•	
			200	•	•	•	•	•	•	•	•	•	•	•	•	•	•	•	•	•	•	
			250	•	•	•	•	•	•	•	•	•	•	•	•	•	•	•	•	•	•	
			315	•	•	•	•	•	•	•	•	•	•	•	•	•	•	•	•	•	•	
				No.: 9	125	•	•	•	•	•	•	•	•	•	•	•	•	•	•	•	•	
				No.: 10	160	•	•	•	•	•	•	•	•	•	•	•	•	•	•	•	•	
				No.: 11	200	•	•	•	•	•	•	•	•	•	•	•	•	•	•	•	•	
					250	•	•	•	•	•	•	•	•	•	•	•	•	•	•	•	•	
					315	•	•	•	•	•	•	•	•	•	•	•	•	•	•	•	•	
RS	Swirl	No.: 14	125	•	•	•	•	•	•	•	•	•	•	•	•	•	•	•	•	•	•	
				160	•	•	•	•	•	•	•	•	•	•	•	•	•	•	•	•	•	•
				200	•	•	•	•	•	•	•	•	•	•	•	•	•	•	•	•	•	•
				250	•	•	•	•	•	•	•	•	•	•	•	•	•	•	•	•	•	•
				315	•	•	•	•	•	•	•	•	•	•	•	•	•	•	•	•	•	•
					No.: 15	125	•	•	•	•	•	•	•	•	•	•	•	•	•	•	•	•
					160	•	•	•	•	•	•	•	•	•	•	•	•	•	•	•	•	
					200	•	•	•	•	•	•	•	•	•	•	•	•	•	•	•	•	
					250	•	•	•	•	•	•	•	•	•	•	•	•	•	•	•	•	
					315	•	•	•	•	•	•	•	•	•	•	•	•	•	•	•	•	
						No.: 16	125	•	•	•	•	•	•	•	•	•	•	•	•	•	•	
							160	•	•	•	•	•	•	•	•	•	•	•	•	•	•	
							200	•	•	•	•	•	•	•	•	•	•	•	•	•	•	
							250	•	•	•	•	•	•	•	•	•	•	•	•	•	•	
							315	•	•	•	•	•	•	•	•	•	•	•	•	•	•	
NS	Nozzles	No.: 19	125	•	•	•	•	•	•	•	•	•	•	•	•	•	•	•	•	•	•	
				160	•	•	•	•	•	•	•	•	•	•	•	•	•	•	•	•	•	•
							200	•	•	•	•	•	•	•	•	•	•	•	•	•	•	
							250	•	•	•	•	•	•	•	•	•	•	•	•	•	•	
							315	•	•	•	•	•	•	•	•	•	•	•	•	•	•	
GS	Grid	No.: 23	125	•	•	•	•	•	•	•	•	•	•	•	•	•	•	•	•	•	•	
				160	•	•	•	•	•	•	•	•	•	•	•	•	•	•	•	•	•	•
							200	•	•	•	•	•	•	•	•	•	•	•	•	•	•	
							250	•	•	•	•	•	•	•	•	•	•	•	•	•	•	
							315	•	•	•	•	•	•	•	•	•	•	•	•	•	•	

Lindab Versio

a series of ceiling adapted diffusers

1

2

3

4

5

6

7

8

9

10

11

12

13

14

15

16

17

18



NS19.

Versio

PS1



PS1 with grille box type V

Description

PS1 is a square perforated diffuser. PS1 can be used for both supply and exhaust air. PS1 is suitable for the horizontal supply of cooled air. PS1 can also be used for low impulse and is therefore useful for the supply of replacement air in environments with high rates of air exchange.

- Suitable for both supply and exhaust air
- The possibility of 1-2-3-way dispersal
- Can be used for low impulse

Order code

Product	PS	a	b	c	d	eee	f
Type	PS						
Design	1 - 2 - 3 - 4						
Box type	V - H - R						
Functional use	S = Supply air E = Exhaust L = Low-impulse			Box type R , only exhaust			
Damper	0 = No damper 1 = Damper 2 = Damper / Meas.outlets	(Box		: H, V) : H, R)			
Connection dim.	Ø200-315 Ø160-315 200x100 - 500x100	(Box		: V) : H) : R)			
Ceiling system	1 - 14						Go to chapter Ceiling tile adaption

Example: PS-1-V-S-0-200-1



PS1 with plenum box type H

Dimensions

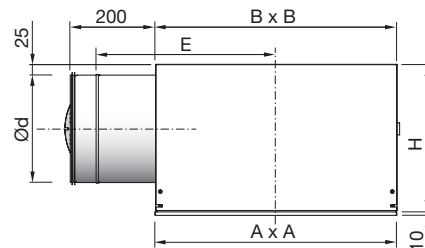

PS1-H	Ød	Pattern	A mm	B mm	H mm	E mm	Weight kg
	160	400	*-	380	250	350	5,9
	200	500	*-	460	290	390	8.50
	250	600	*-	560	340	420	12.3
	315	600	*-	560	405	420	13.1

* Face plate dimension A x A depends on ceiling system. See "Ceiling adjustment" for detailed dimensions. For further details on plenum box - see "Plenum boxes".

Maintenance

The face plate can be removed to enable cleaning of internal parts or to gain access to the duct or box. The visible parts of the diffuser can be wiped with a damp cloth.

Materials and finish

Grille box/plenum box:

Material: Galvanised steel

Face plate:

Material: Galvanised steel

Standard finish: Powder-coated

Standard colour: RAL 9010, gloss 30

The diffuser is available in other colours. Please contact Lindab's sales department for further information.

Versio

PS1

Accessories

Blending profiles (set)

MDR

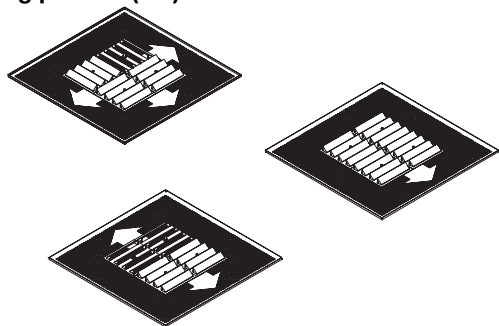

Order code

Product MDR aaa
 Type _____
 Pattern _____

Example: MDR-200

Extension piece

MBZ

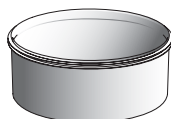

Order code

Product MBZ aaa
 Type _____
 Size _____

Example: MBZ-200

Mounting bracket

PBB



Suspension

MHS



Order code

Product _____
 Type _____
 _____ aaa

Example: MHS

Plenum box MBB



PS1-V + MBB

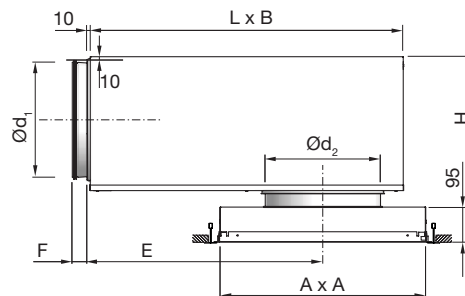

PS1-V + MBB		Pattern	B mm	E mm	F mm	H* mm	L mm
duct Ød ₁ mm	PS1-V Ød ₂ mm						
125	200	400	310	262	50	280 - 320	376
160	200	400	380	323	50	314 - 354	459
160	250	500	380	323	50	314 - 354	459
200	200	400	460	396	70	355 - 395	565
200	250	500	460	396	70	355 - 395	565
200	315	600	460	396	70	355 - 395	565
250	250	500	540	486	70	405 - 445	698
250	315	600	540	486	70	405 - 445	698
315	315	600	540	646	70	470 - 510	858

* Using accessory MBZ the H dimension will increase:

Ød₂ = 200 mm => H +40 mm

Ød₂ = 250 - 315 mm => H +60 mm

Order code

Product MBB aaa bbb c
 Type _____
 MBB _____
 Duct connection Ød₁ _____
 Ø125-315 _____
 Diffuser dimension Ød₂ _____
 Ø200-315 _____
 Functional use _____
 S = Supply air
 E = Exhaust

Example: PS-1-V-S-0-200-1+MBB-200-200-S

Versio

PS1

Technical data

Capacity

Air flow q_v [l/s] and [m³/h], total pressure Δp_t [Pa], throw $l_{0,2}$ [m] and sound power level L_{WA} [dB(A)] can be seen in the diagrams.

Frequency-related sound effect level

The sound effect level in the frequency band is defined as $L_{WA}+K_{ok}$. K_{ok} values are specified in charts beneath the diagrams on the following pages.

Quick selection, supply air

PS1-V + MBB

PS1-V + MBB		$\Delta p_t \geq 50$ Pa		$\Delta p_t \geq 50$ Pa	
duct	PS1-V	30 dB(A)		35 dB(A)	
$\varnothing d_1$	$\varnothing d_2$	l/s	m ³ /h	l/s	m ³ /h
125	200	58	209	70	252
160	200	63	227	77	277
160	250	71	256	90	324
200	200	82	295	97	349
200	250	88	317	108	389
200	315	108	389	139	500
250	250	106	382	124	446
250	315	124	446	150	540
315	315	152	547	183	659

Supply air

PS1 + H

PS1 + H	Minimum		$\Delta p_t \geq 50$ Pa		$\Delta p_t \geq 50$ Pa	
	l/s	m ³ /h	30 dB(A)		35 dB(A)	
Size $\varnothing d$			l/s	m ³ /h	l/s	m ³ /h
mm						
160	30	108	51	184	57	205
200	49	176	69	248	83	299
250	49	176	93	335	114	410
315	82	295	140	504	164	590

Sound attenuation

Sound attenuation of the diffusers ΔL from duct to room, including end reflection - see table below.

PS1-V + MBB

PS1-V + MBB		Centre frequency Hz							
duct	PS1-V	63	125	250	500	1K	2K	4K	8K
$\varnothing d_1$	$\varnothing d_2$								
125	200	14	11	4	15	15	15	16	17
160	200	14	14	7	22	18	17	19	20
160	250	14	14	4	17	15	15	16	19
200	200	13	10	7	16	19	17	19	18
200	250	11	9	6	15	17	15	18	16
200	315	13	8	3	12	16	14	16	15
250	250	14	8	8	16	18	17	17	18
250	315	14	7	5	14	16	15	16	17
315	315	8	9	9	15	17	16	17	21

PS1 + H

PS1 + H	Centre frequency Hz							
Size $\varnothing d$	63	125	250	500	1K	2K	4K	8K
mm								
160	18	15	5	13	11	11	9	10
200	16	10	6	15	11	11	12	14
250	14	9	7	13	8	9	12	14
315	12	8	8	14	10	9	11	14

Mounting -and balancing instruction

For further information go to www.lindab.com and installation -and balancing instruction.

Versio

PS1

Technical data

Throw $l_{0.2}$

Throw $l_{0.2}$ [m] is specified at a terminal velocity of 0.2 m/s.

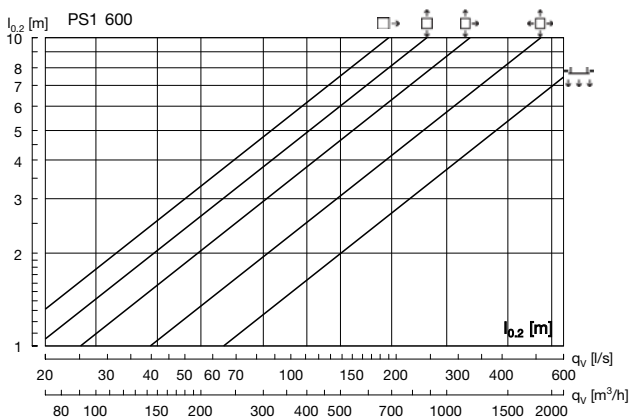
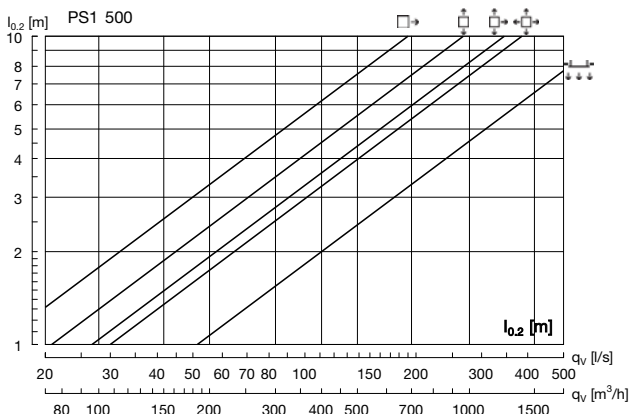
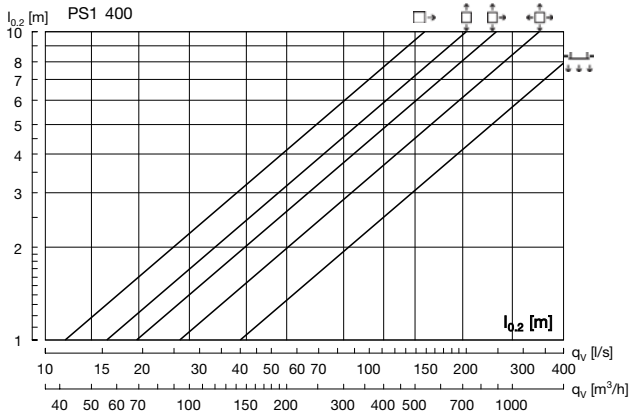

PS1-V without MBB

Supply air

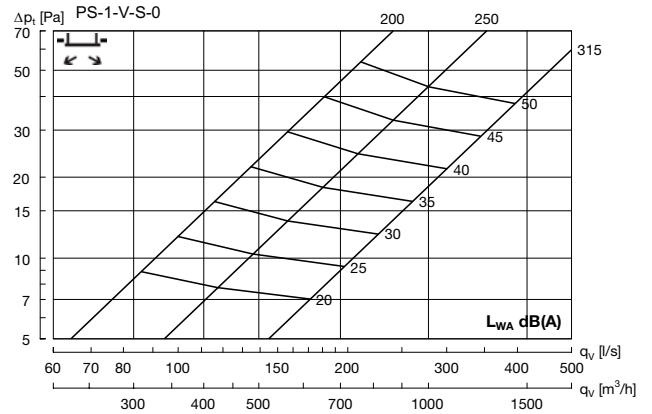

Low-impulse

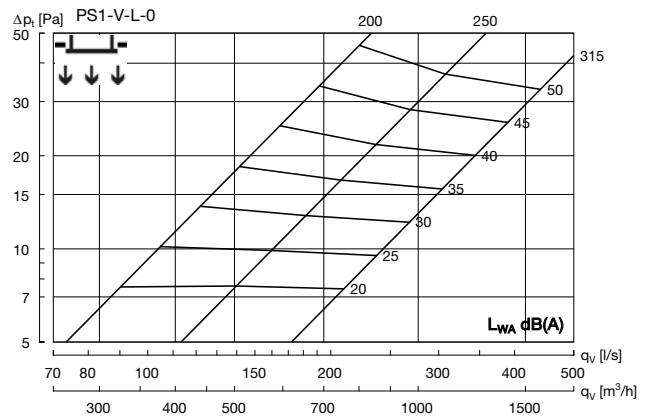

Concerning low impulse, go to planning guide in chapter 12 "Low impulse"

Versio

PS1

Technical data

PS1-V 200 + MBB - Supply air

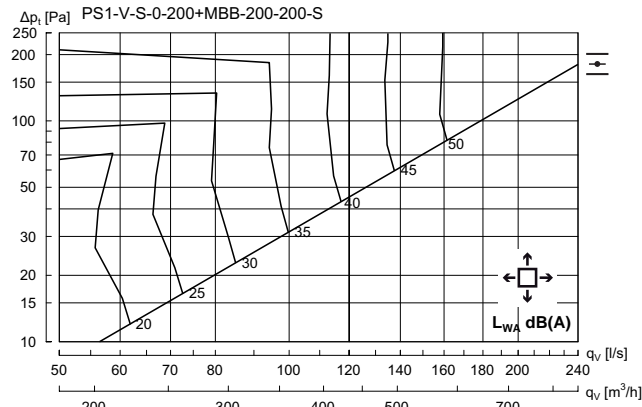

Hz	63	125	250	500	1K	2K	4K	8K
K_{ok}	13	0	-6	0	-4	-17	-25	-32

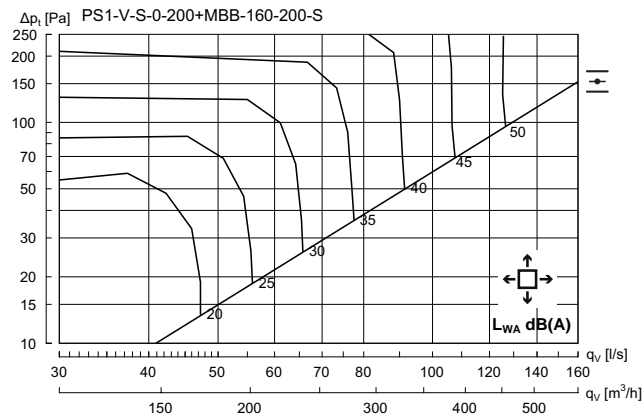

Hz	63	125	250	500	1K	2K	4K	8K
K_{ok}	8	3	-3	-1	-4	-14	-21	-27

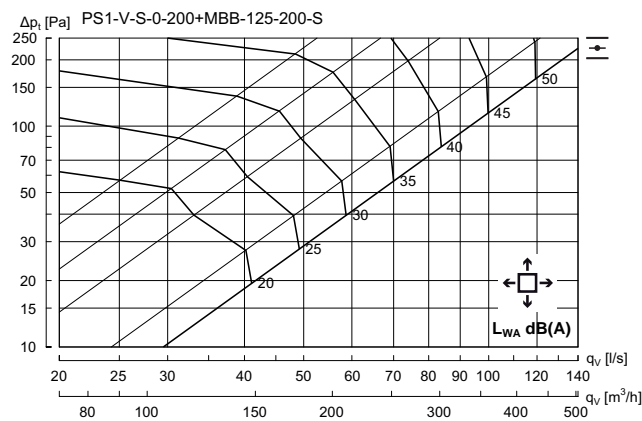

Hz	63	125	250	500	1K	2K	4K	8K
K_{ok}	9	5	1	-2	-6	-10	-15	-22

PS1-V 250 + MBB - Supply air

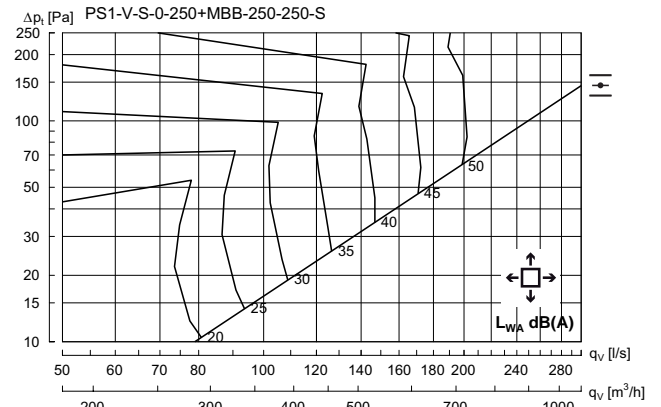

Hz	63	125	250	500	1K	2K	4K	8K
K_{ok}	10	-1	-6	0	-4	-18	-25	-33

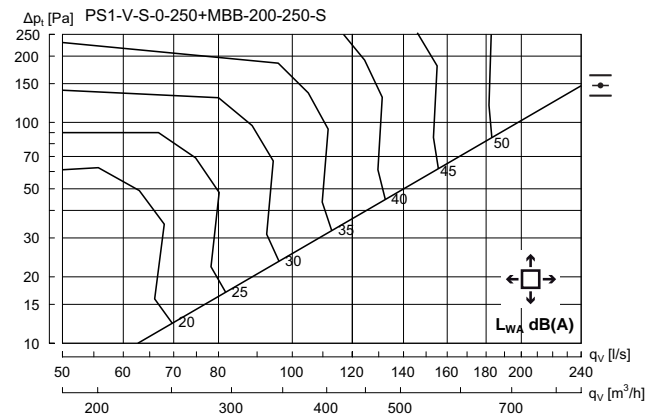

Hz	63	125	250	500	1K	2K	4K	8K
K_{ok}	9	4	-4	-1	-4	-15	-22	-28

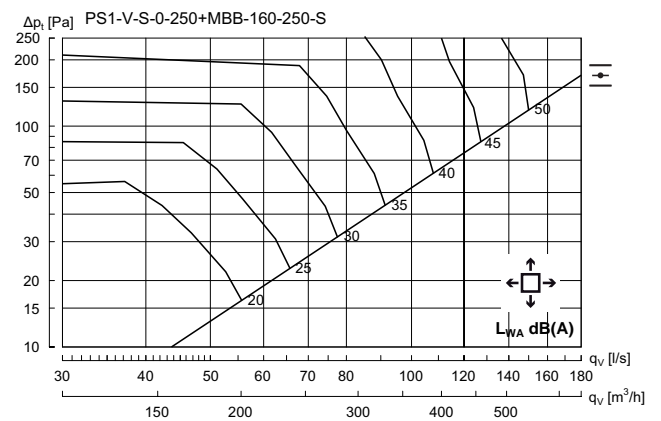

Hz	63	125	250	500	1K	2K	4K	8K
K_{ok}	15	3	-1	-3	-4	-12	-19	-24



Versio

PS1

Technical data

PS1-V 315 + MBB - Supply air

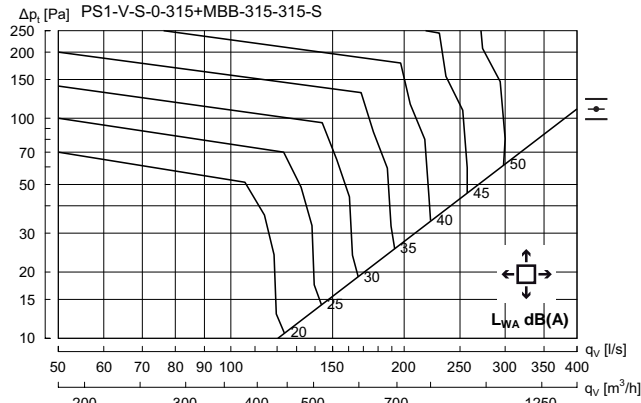

Hz	63	125	250	500	1K	2K	4K	8K
K_{ok}	12	0	-3	-1	-4	-16	-22	-28

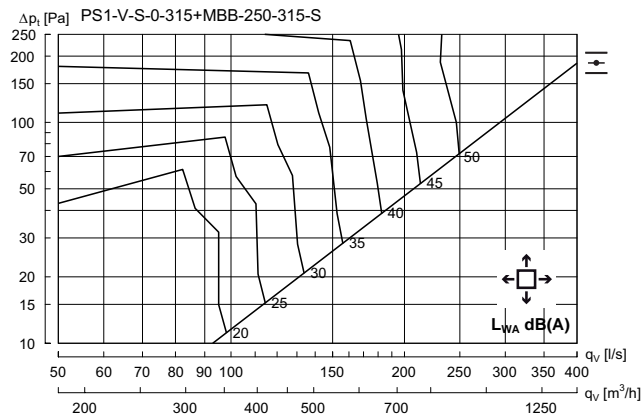

Hz	63	125	250	500	1K	2K	4K	8K
K_{ok}	9	4	-3	-1	-4	-15	-22	-28

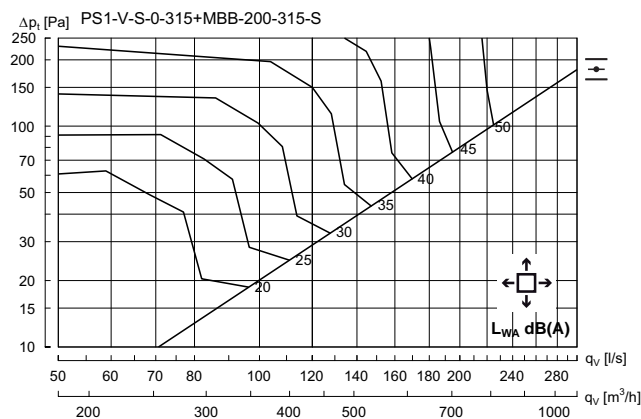

Hz	63	125	250	500	1K	2K	4K	8K
K_{ok}	10	5	-1	-2	-4	-12	-19	-25

Low-impulse correction, sound power level (L_{WA}) and pressure loss (Δp_t)

On the previous pages you can find diagrams for all sizes PS1-V+MBB supply air. When low-impulse values are wanted, use the correction factors in the table below.

PS1-V + MBB

duct $\varnothing d_1$	PS1-V $\varnothing d_2$	Low-impulse Correction factor	
		L_{WA}	Δp_t
125	200	-1	x 1
160	200	-2	x 0,9
160	250	0	x 1
200	200	-3	x 0,9
200	250	0	x 1
200	315	0	x 1
250	250	0	x 1
250	315	0	x 1
315	315	0	x 1

Concerning low impulse, go to planning guide in chapter 12 "Low impulse"

Versio

PS1

Technical data

PS1-V without MBB

Exhaust air

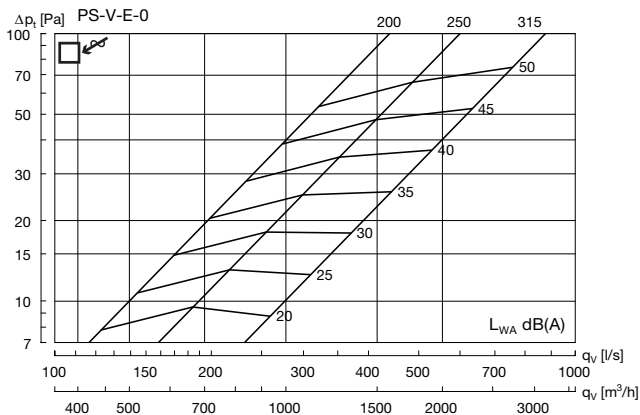

PS1-V 200 + MBB - Exhaust air

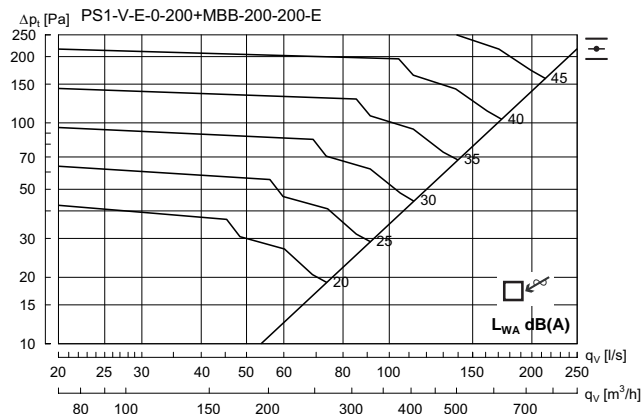

Hz	63	125	250	500	1K	2K	4K	8K
K _{ok}	15	5	1	-3	-6	-10	-14	-23

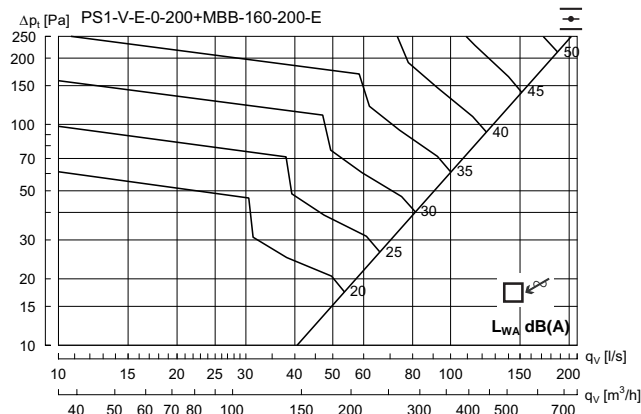

Hz	63	125	250	500	1K	2K	4K	8K
K _{ok}	16	6	0	-3	-7	-9	-15	-21

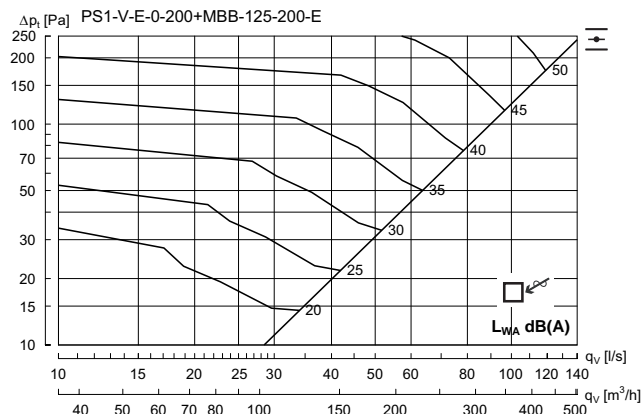

Hz	63	125	250	500	1K	2K	4K	8K
K _{ok}	10	4	2	-2	-6	-10	-15	-22



Technical data

PS1-V 250 + MBB - Exhaust air

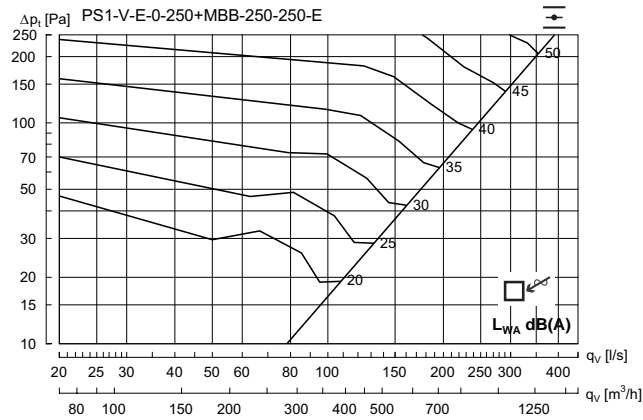

Hz	63	125	250	500	1K	2K	4K	8K
K_{ok}	10	6	2	-3	-6	-10	-15	-23

PS1-V 315 + MBB - Exhaust air

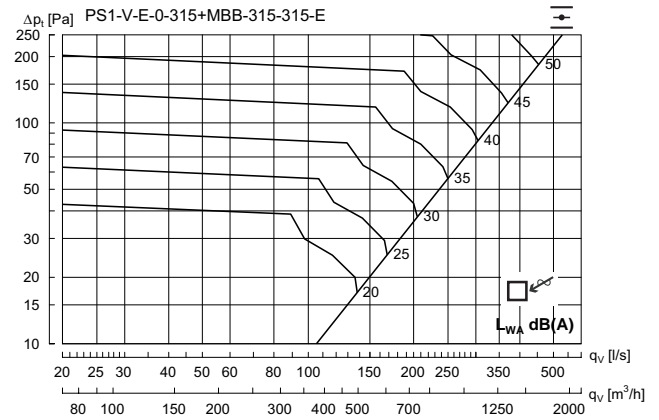

Hz	63	125	250	500	1K	2K	4K	8K
K_{ok}	11	5	3	-3	-7	-10	-15	-26

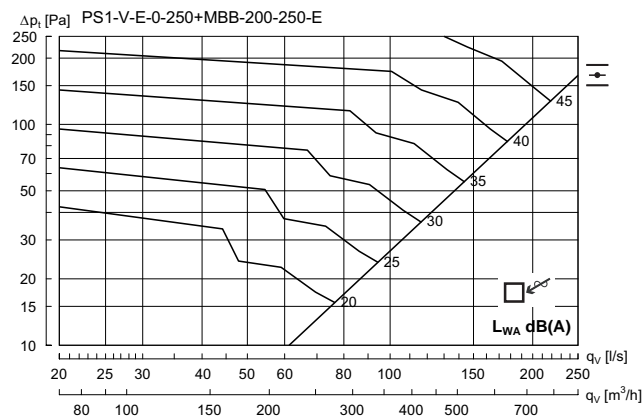

Hz	63	125	250	500	1K	2K	4K	8K
K_{ok}	14	5	1	-3	-5	-10	-15	-22

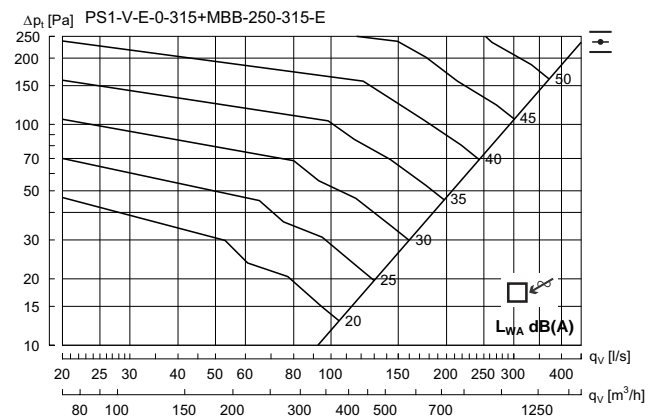

Hz	63	125	250	500	1K	2K	4K	8K
K_{ok}	11	5	2	-3	-6	-11	-16	-23

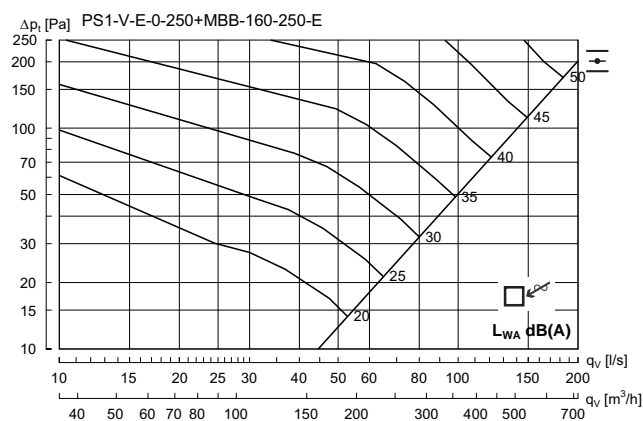

Hz	63	125	250	500	1K	2K	4K	8K
K_{ok}	15	6	0	-3	-6	-9	-14	-21

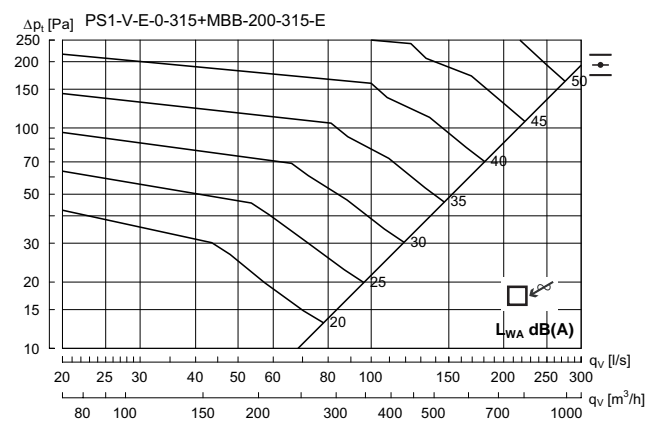

Hz	63	125	250	500	1K	2K	4K	8K
K_{ok}	13	5	1	-3	-6	-10	-14	-22

Versio

PS1

Technical data

PS1+H - Supply air

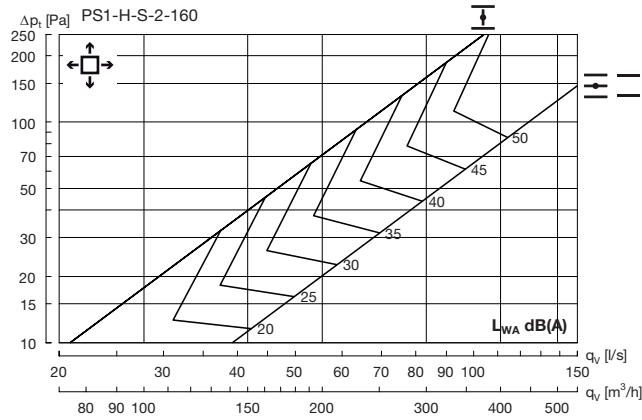

Hz	63	125	250	500	1K	2K	4K	8K
K_{ok}	8	4	3	-3	-6	-11	-15	-14

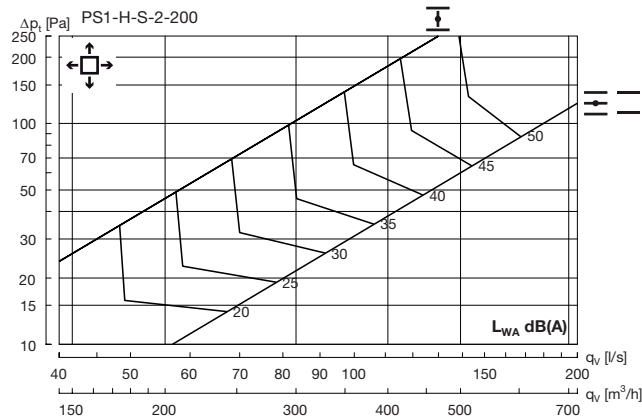

Hz	63	125	250	500	1K	2K	4K	8K
K_{ok}	5	5	1	-1	-7	-12	-12	-18

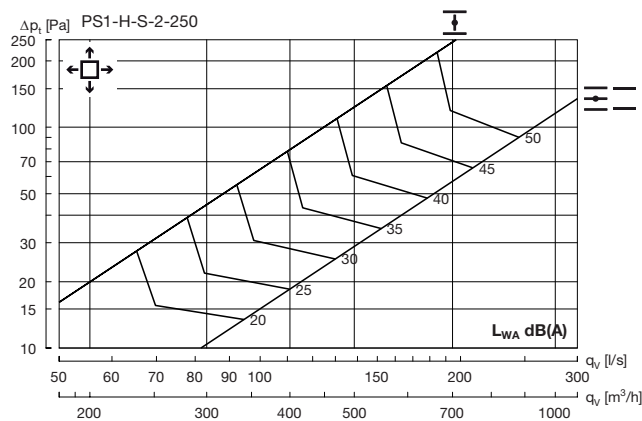

Hz	63	125	250	500	1K	2K	4K	8K
K_{ok}	9	5	2	-1	-7	-14	-18	-19

PS1+H - Supply air

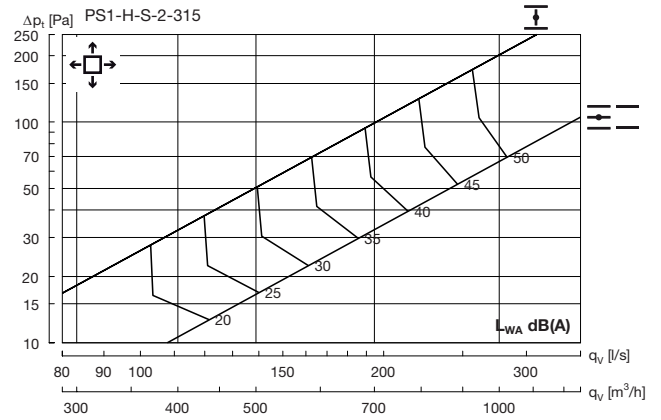

Hz	63	125	250	500	1K	2K	4K	8K
K_{ok}	13	4	0	-1	-6	-13	-17	-27

- 1
- 2
- 3
- 4
- 5
- 6
- 7
- 8
- 9
- 10
- 11
- 12
- 13
- 14
- 15
- 16
- 17
- 18

Versio

PS1

Technical data

PS1+H - Exhaust air

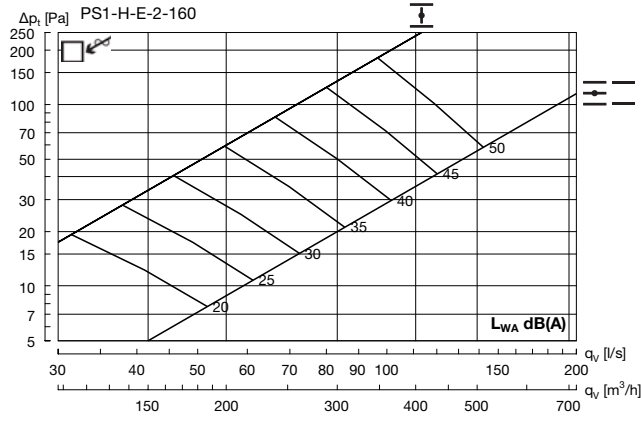

Hz	63	125	250	500	1K	2K	4K	8K
K_{ok}	10	4	6	-3	-11	-12	-19	-25

PS1+H - Exhaust air

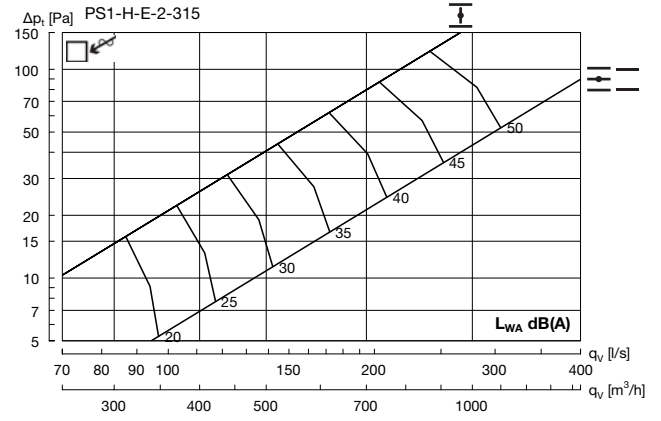

Hz	63	125	250	500	1K	2K	4K	8K
K_{ok}	11	3	1	1	-8	-16	-26	-37

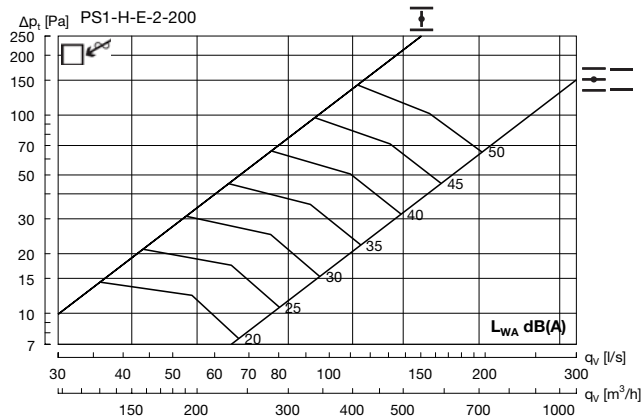

Hz	63	125	250	500	1K	2K	4K	8K
K_{ok}	10	4	5	-2	-9	-13	-21	-29

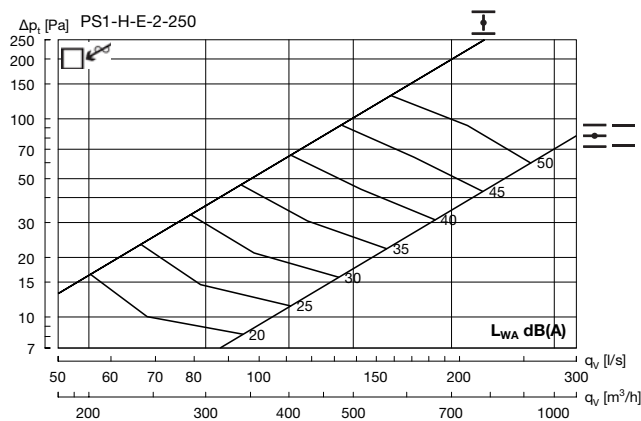

Hz	63	125	250	500	1K	2K	4K	8K
K_{ok}	11	5	2	-2	-6	-12	-22	-32

Versio

PS8



PS8 with grille box type V

Description

PS8 is a square perforated diffuser with swirl insert. PS8 fits naturally into the ceiling and maintains the excellent technical properties of swirl diffusers. The swirl pattern ensures high induction and a large dynamic range, and is therefore ideal for the horizontal supply of very cold air.

- Discrete appearance
- Large dynamic range
- High induction
- Ideal for the supply of very cold air

Order code

Product		PS	a	b	S	d	eee	f
Type								
PS								
Design								
8 - 9 - 10 - 11								
Box type								
V - H - R								
Functional use								
S = Supply air								
Damper								
0 = No damper (Box : H, V)								
1 = Damper (Box : H, R)								
2 = Damper / Meas.outlets (Box : H)								
Connection dim.								
Ø160-315 (Box : V)								
Ø125-315 (Box : H)								
200x100 - 500x100 (Box : R)								
Ceiling system								
1 - 14								Go to chapter Ceiling tile adaption

Example: PS-8-V-S-0-200-1



PS8 with plenum box type H

Dimensions

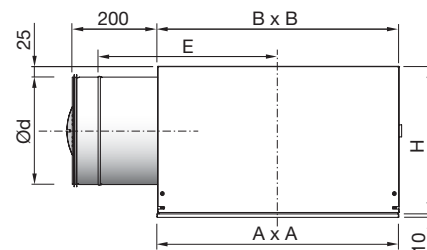

PS8-H	Ød	Pattern	A mm	B mm	H mm	E mm	Weight kg
	125	300	*-	380	215	350	5.9
	160	400	*-	380	250	350	5.9
	200	500	*-	460	290	390	8.5
	250	600	*-	560	340	420	12.3
	315	600	*-	560	405	420	13.1

* Face plate dimension depends on ceiling system. See "Ceiling adjustment" for detailed dimensions. For further details on plenum box - see "Plenum boxes".

Maintenance

The face plate can be removed to enable cleaning of internal parts or to gain access to the duct or box. The visible parts of the diffuser can be wiped with a damp cloth.

Materials and finish

Grille box/plenum box:

Material: Galvanised steel

Face plate:

Material: Galvanised steel

Standard finish: Powder-coated

Standard colour: RAL 9010, gloss 30

The diffuser is available in other colours. Please contact Lindab's sales department for further information.

Versio

PS8

Accessories

Extension piece

MBZ

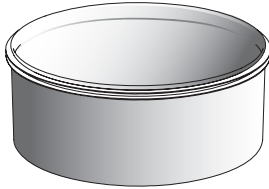

Order code

Product **MBZ** **aaa**
 Type _____
 Size _____

Example: MBZ-200

Mounting bracket

PBB



Suspension

MHS



Order code

Product _____ **aaa**
 Type _____

Example: MHS

Plenum box

MBB



PS8-V + MBB

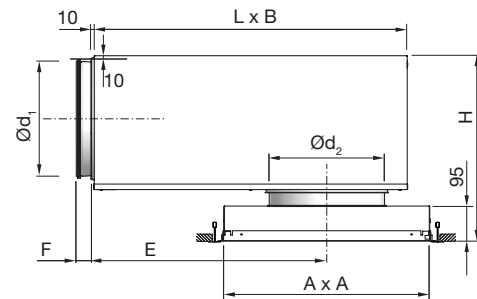

PS8-V + MBB		Pattern	B mm	E mm	F mm	H* mm	L mm
duct Ød ₁ mm	PS8-V Ød ₂ mm						
100	160	300	260	216	50	255 - 295	310
125	160	300	310	262	50	280 - 320	376
125	200	400	310	262	50	280 - 320	376
160	160	300	380	323	50	314 - 354	459
160	200	400	380	323	50	314 - 354	459
160	250	500	380	323	50	314 - 354	459
200	200	400	460	396	70	355 - 395	565
200	250	500	460	396	70	355 - 395	565
200	315	600	460	396	70	355 - 395	565
250	250	500	540	486	70	405 - 445	698
250	315	600	540	486	70	405 - 445	698
315	315	600	540	646	70	470 - 510	858

* Using accessory MBZ the H dimension will increase:
 Ød₂ = 160 - 200 mm => H +40 mm
 Ød₂ = 250 - 315 mm => H +60 mm

Order code

Product **MBB** **aaa** **bbb** **c**
 Type _____
 MBB _____
 Duct connection Ød₁ _____
 Ø100-315 _____
 Diffuser dimension Ød₂ _____
 Ø160-315 _____
 Functional use _____
 S = Supply air
 E = Exhaust

Example: PS-8-V-S-0-200-1+MBB-200-200-S

Versio

PS8

Technical data

Capacity

Air flow q_v [l/s] and [m³/h], total pressure Δp_t [Pa], throw $l_{0,2}$ [m] and sound power level L_{WA} [dB(A)] can be seen in the diagrams.

Frequency-related sound effect level

The sound effect level in the frequency band is defined as $L_{WA}+K_{ok}$. K_{ok} values are specified in charts beneath the diagrams on the following pages.

Quick selection, supply air

PS8-V + MBB

PS8-V + MBB		$\Delta p_t \geq 50$ Pa		$\Delta p_t \geq 50$ Pa	
duct	PS8-V	30 dB(A)		35 dB(A)	
$\varnothing d_1$	$\varnothing d_2$	l/s	m ³ /h	l/s	m ³ /h
100	160	31	112	38	137
125	160	36	130	43	155
125	200	48	173	60	216
160	160	37	133	44	158
160	200	52	187	62	223
160	250	67	241	84	302
200	200	59	212	70	252
200	250	82	295	98	353
200	315	72	259	88	317
250	250	83	299	97	349
250	315	81	292	96	346
315	315	-	-	102	367

Supply air

PS8 + H

PS8 + H		$\Delta p_t \geq 50$ Pa		$\Delta p_t \geq 50$ Pa		
Size $\varnothing d$	Minimum	30 dB(A)		35 dB(A)		
mm	l/s	m ³ /h	l/s	m ³ /h	l/s	m ³ /h
125	26	93	23	83	29	104
160	33	118	46	166	54	194
200	57	204	61	220	74	266
250	71	254	-	-	106	382
315	95	342	-	-	-	-

Sound attenuation

Sound attenuation of the diffusers ΔL from duct to room, including end reflection - see table below.

PS8-V + MBB

PS8-V + MBB		Centre frequency Hz							
duct	PS8-V	63	125	250	500	1K	2K	4K	8K
$\varnothing d_1$	$\varnothing d_2$								
100	160	18	16	5	17	20	19	17	21
125	160	16	13	9	19	18	18	18	20
125	200	14	11	5	15	16	17	17	19
160	160	15	16	11	23	20	20	21	21
160	200	15	15	8	22	20	18	20	20
160	250	16	13	5	18	16	16	17	20
200	200	14	11	7	17	21	17	20	18
200	250	14	9	5	14	18	15	18	17
200	315	13	9	3	13	17	15	17	16
250	250	13	8	7	17	18	18	18	18
250	315	16	7	5	16	16	17	17	18
315	315	9	9	9	16	17	17	18	23

PS8 + H

PS8 + H		Centre frequency Hz							
Size $\varnothing d$		63	125	250	500	1K	2K	4K	8K
mm									
125		18	13	8	19	14	11	12	15
160		18	12	3	14	13	7	7	8
200		14	9	3	14	9	7	8	11
250		14	8	7	10	8	7	9	12
315		12	6	8	13	8	7	10	12

Installation -and balancing instruction

For further information go to www.lindab.com and Installation -and balancing instruction.

Versio

PS8

Technical data

Throw $l_{0,2}$

Throw $l_{0,2}$ [m] is specified at a terminal velocity of 0.2 m/s. The designation by the lines specifies the pattern on the face plate.

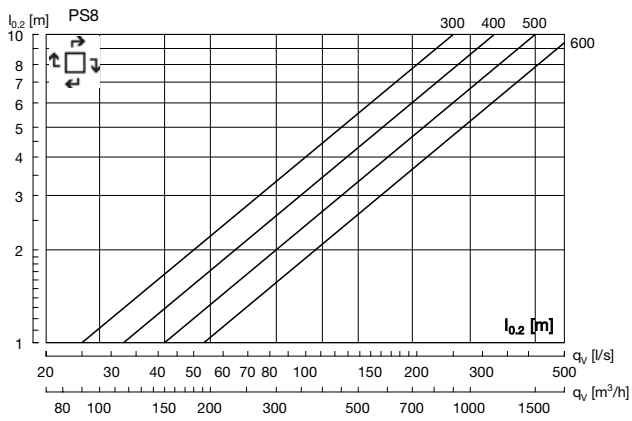

PS8-V without plenum box – Supply air

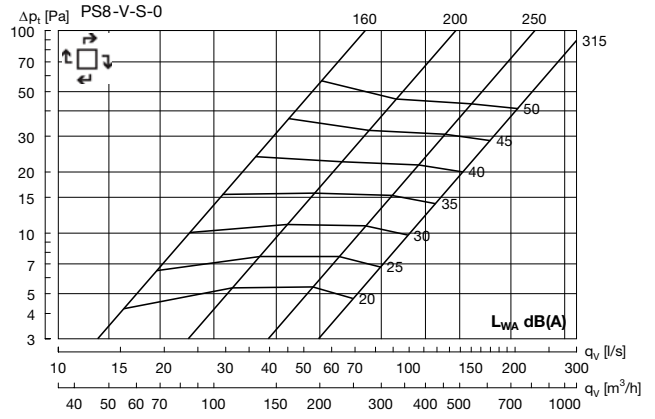

Versio

PS8

Technical data

PS8-V 160 + MBB - Supply air

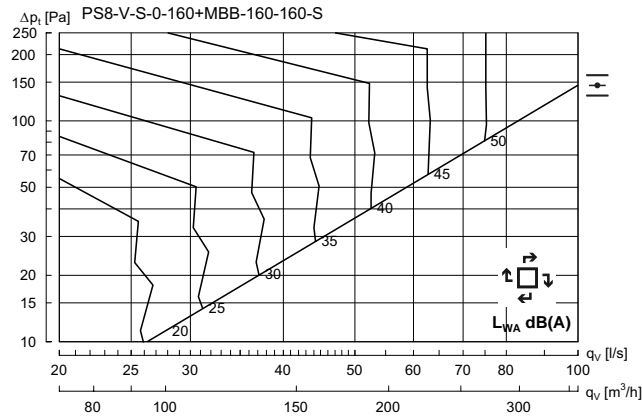

Hz	63	125	250	500	1K	2K	4K	8K
K_{ok}	9	0	-2	1	-7	-17	-28	-38

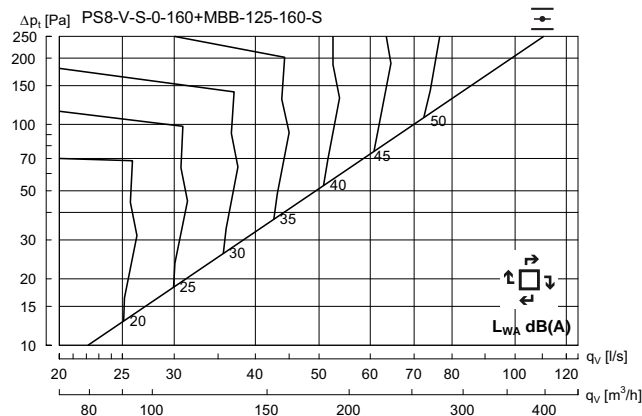

Hz	63	125	250	500	1K	2K	4K	8K
K_{ok}	8	3	-1	1	-7	-16	-24	-31

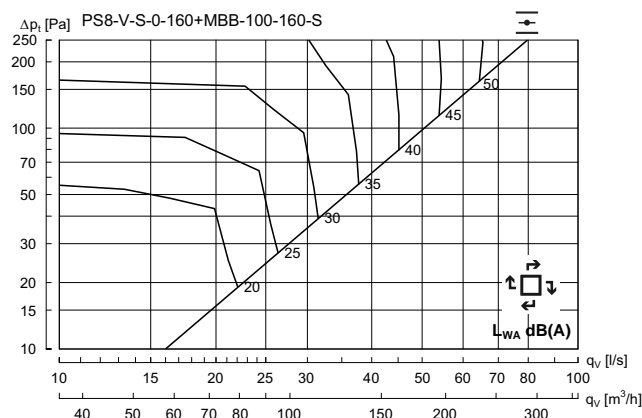

Hz	63	125	250	500	1K	2K	4K	8K
K_{ok}	10	3	3	-1	-8	-14	-18	-23

PS8-V 200 + MBB - Supply air

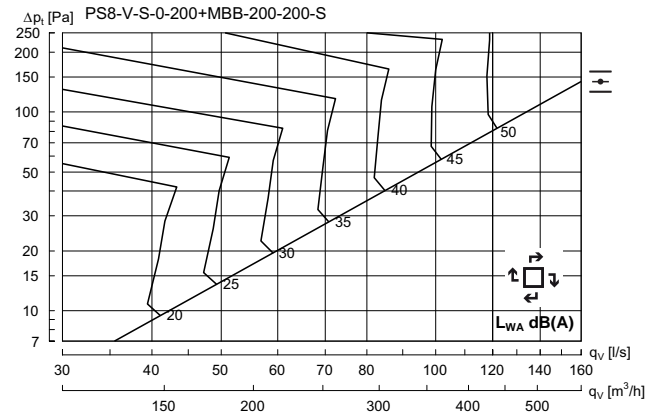

Hz	63	125	250	500	1K	2K	4K	8K
K_{ok}	13	0	-5	1	-6	-20	-29	-40

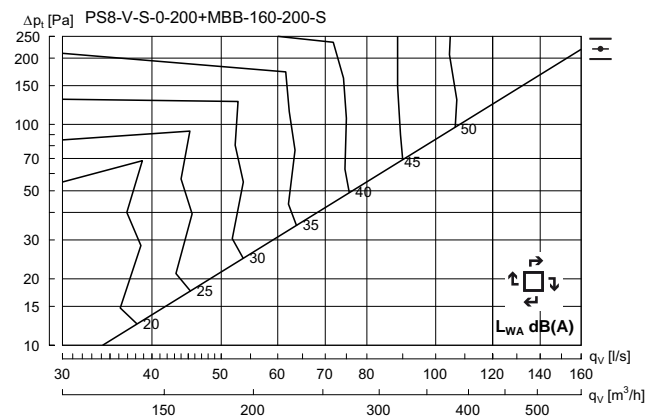

Hz	63	125	250	500	1K	2K	4K	8K
K_{ok}	6	3	-2	1	-6	-16	-22	-30

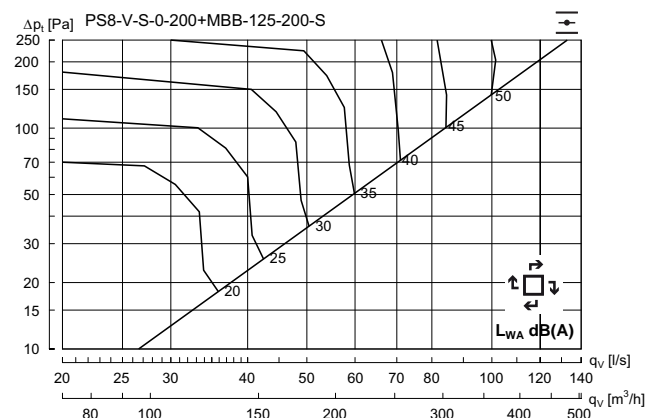

Hz	63	125	250	500	1K	2K	4K	8K
K_{ok}	6	5	2	-1	-6	-13	-19	-25



Versio

PS8

Technical data

PS8-V 250 + MBB - Supply air

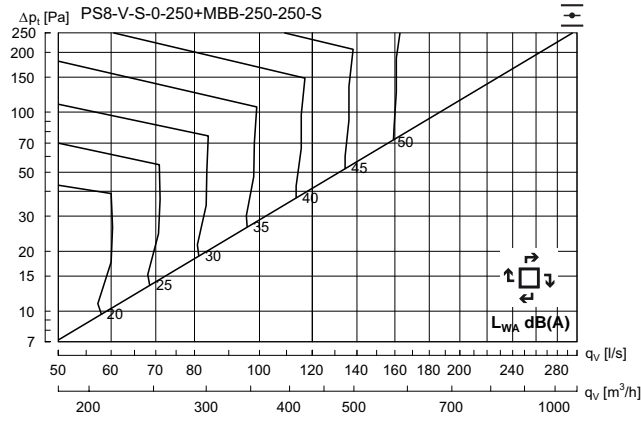

Hz	63	125	250	500	1K	2K	4K	8K
K_{ok}	8	0	-5	1	-6	-19	-28	-40

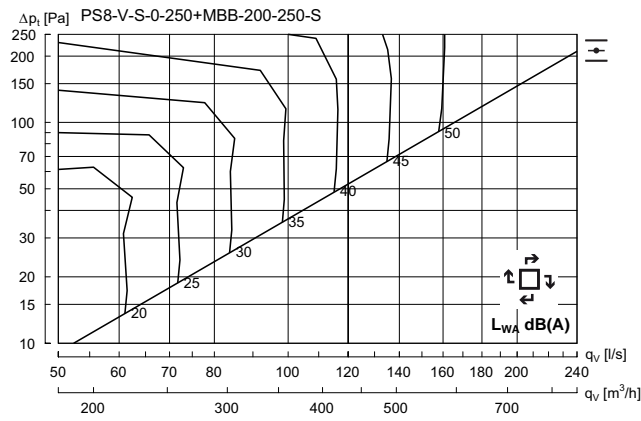

Hz	63	125	250	500	1K	2K	4K	8K
K_{ok}	12	4	-2	0	-6	-16	-20	-26

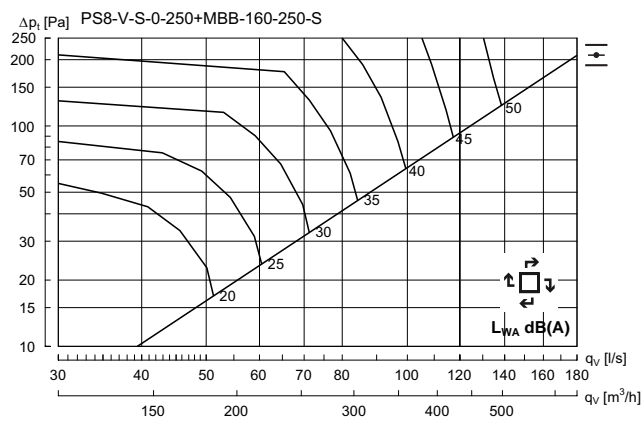

Hz	63	125	250	500	1K	2K	4K	8K
K_{ok}	15	5	1	-2	-5	-13	-20	-26

PS8-V 315 + MBB - Supply air

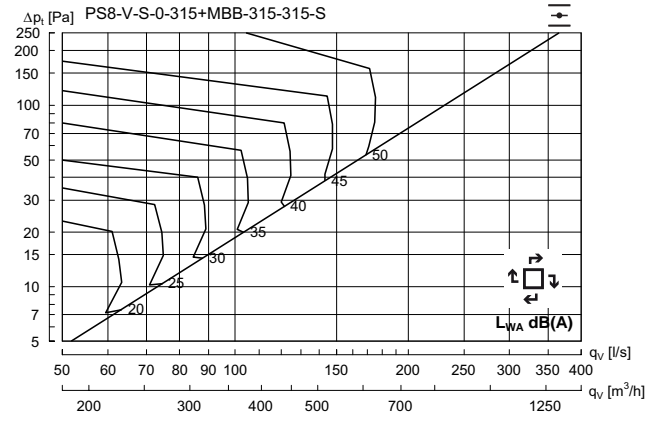

Hz	63	125	250	500	1K	2K	4K	8K
K_{ok}	11	-4	-2	1	-7	-21	-26	-35

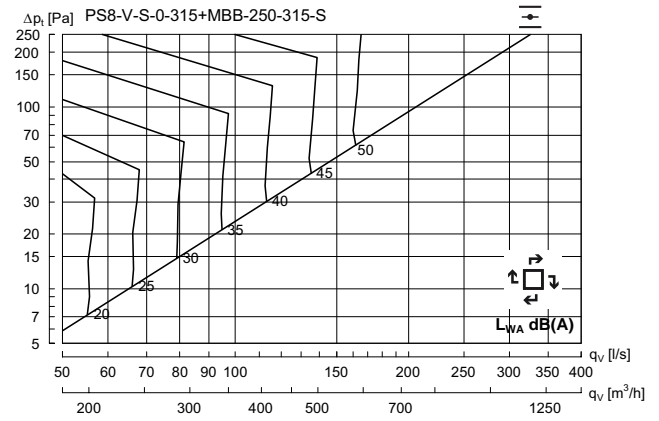

Hz	63	125	250	500	1K	2K	4K	8K
K_{ok}	8	0	-3	2	-8	-21	-29	-39

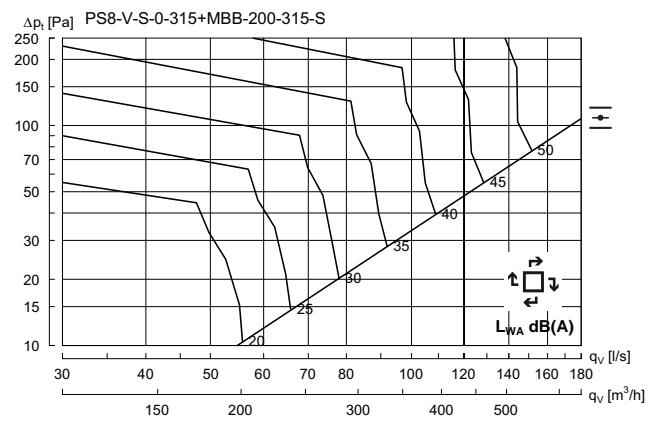

Hz	63	125	250	500	1K	2K	4K	8K
K_{ok}	10	2	-1	1	-7	-18	-23	-29

Versio

PS8

Technical data

PS8 + H - Supply air

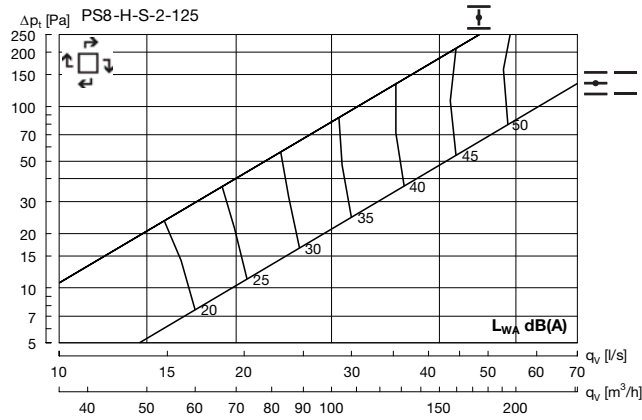

Hz	63	125	250	500	1K	2K	4K	8K
K_{ok}	3	4	4	0	-10	-18	-25	-31

PS8 + H - Supply air

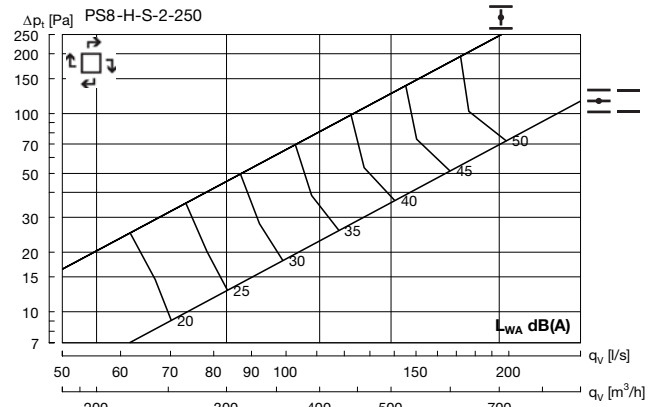

Hz	63	125	250	500	1K	2K	4K	8K
K_{ok}	5	6	4	-1	-8	-18	-26	-33

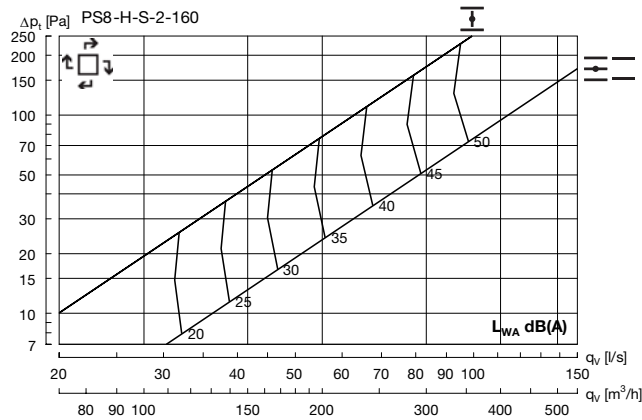

Hz	63	125	250	500	1K	2K	4K	8K
K_{ok}	1	3	5	-2	-9	-19	-25	-32

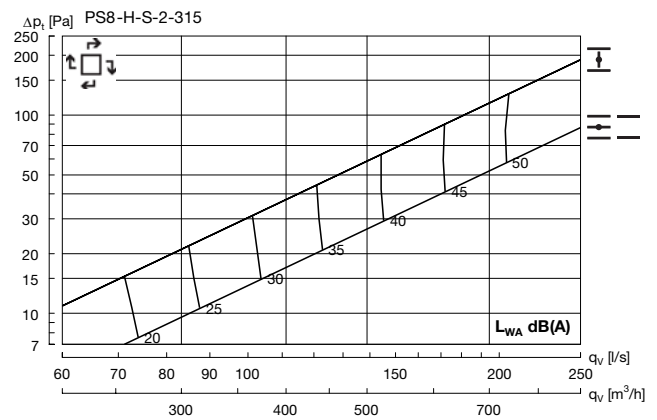

Hz	63	125	250	500	1K	2K	4K	8K
K_{ok}	7	5	3	0	-9	-21	-31	-41

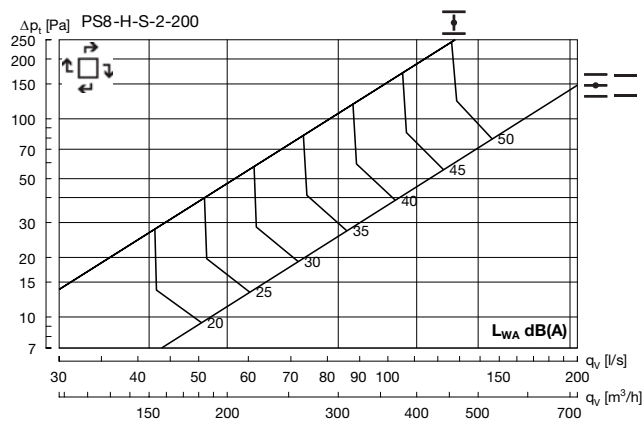

Hz	63	125	250	500	1K	2K	4K	8K
K_{ok}	7	7	3	-1	-7	-16	-23	-29



Versio

RS14



RS14 with grille box type V

Description

RS14 is a square swirl diffuser with fixed bars. RS14 can be used for both supply and exhaust air. The swirl pattern ensures high induction and a large dynamic range. It is therefore ideal for the horizontal supply of very cold air.

- Large dynamic range
- High induction
- Suitable for cooling at very low temperatures
- Can be used for both supply air and exhaust

Order code

Product	RS	14	b	c	d	eee	f
Type	RS						
Design	14						
Box type	V - H - R						
Functional use	S = Supply air E = Exhaust						
Damper	0 = No damper (Box : H, V) 1 = Damper (Box : H, R) 2 = Damper / Meas.outlets (Box : H)						
Connection dim.	Ø160-315 (Box : V) Ø125-315 (Box : H) 200x100 - 500x100 (Box : R)						
Ceiling system	1 - 14	Go to chapter Ceiling tile adaption					

Example: RS-14-V-S-0-200-1



RS14 with plenum box type H

Dimensions

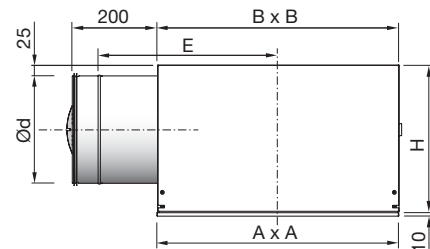

RS14-H	A	B	H	E	Weight	
Ød	Pattern	mm	mm	mm	kg	
125	400	*-	380	215	350	5.9
160	400	*-	380	250	350	5.9
200	500	*-	460	290	390	8.5
250	600	*-	560	340	420	12.3
315	600	*-	560	405	420	13.1

* Face plate dimension A x A depends on ceiling system. See "Ceiling adjustment" for detailed dimensions. For further details on plenum box - see "Plenum boxes".

Maintenance

The face plate can be removed to enable cleaning of internal parts or to gain access to the duct or box. The visible parts of the diffuser can be wiped with a damp cloth.

Materials and finish

Grille box/plenum box:

Material: Galvanised steel

Face plate:

Material: Galvanised steel

Standard finish: Powder-coated

Standard colour: RAL 9010, gloss 30

The diffuser is available in other colours. Please contact Lindab's sales department for further information.

Versio

RS14

Accessories

Extension piece

MBZ

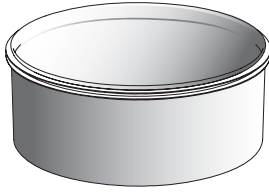

Order code

Product MBZ aaa
 Type _____
 Size _____

Example: MBZ-200

Mounting bracket

PBB



Suspension

MHS



Order code

Product _____ aaa
 Type _____

Example: MHS

Plenum box

MBB



RS14-V + MBB

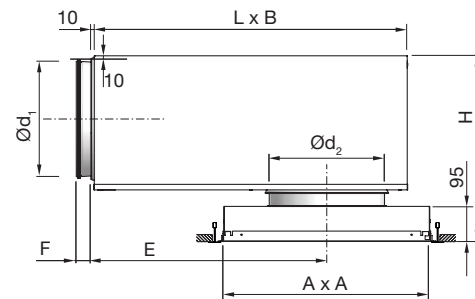

RS14-V + MBB		Pattern	B mm	E mm	F mm	H* mm	L mm
duct Ød ₁ mm	RS14-V Ød ₂ mm						
100	160	300	260	216	50	255 - 295	310
125	160	300	310	262	50	280 - 320	376
125	200	400	310	262	50	280 - 320	376
160	160	300	380	323	50	314 - 354	459
160	200	400	380	323	50	314 - 354	459
160	250	500	380	323	50	314 - 354	459
200	200	400	460	396	70	355 - 395	565
200	250	500	460	396	70	355 - 395	565
200	315	600	460	396	70	355 - 395	565
250	250	500	540	486	70	405 - 445	698
250	315	600	540	486	70	405 - 445	698
315	315	600	540	646	70	470 - 510	858

* Using accessory MBZ the H dimension will increase:
 Ød₂ = 160 - 200 mm => H +40 mm
 Ød₂ = 250 - 315 mm => H +60 mm

Order code

Product MBB aaa bbb c
 Type _____
 MBB _____
 Duct connection Ød₁ _____
 Ø100-315 _____
 Diffuser dimension Ød₂ _____
 Ø160-315 _____
 Functional use _____
 S = Supply air
 E = Exhaust

Example: RS-14-V-S-0-200-1+MBB-200-200-S

Versio

RS14

Technical data

Capacity

Air flow q_v [l/s] and [m³/h], total pressure Δp_t [Pa], throw $l_{0,2}$ [m] and sound power level L_{WA} [dB(A)] can be seen in the diagrams.

Frequency-related sound effect level

The sound effect level in the frequency band is defined as $L_{WA}+K_{ok}$. K_{ok} values are specified in charts beneath the diagrams on the following pages.

Quick selection, supply air

RS14-V + MBB

RS14-V + MBB		$\Delta p_t \geq 50$ Pa		$\Delta p_t \geq 50$ Pa	
duct	RS14-V	30 dB(A)		35 dB(A)	
$\varnothing d_1$	$\varnothing d_2$	l/s	m ³ /h	l/s	m ³ /h
100	160	33	119	41	148
125	160	44	158	52	187
125	200	49	176	59	212
160	160	38	137	46	166
160	200	51	184	62	223
160	250	67	241	85	306
200	200	65	234	77	277
200	250	77	277	95	342
200	315	100	360	124	446
250	250	89	320	104	374
250	315	110	396	132	475
315	315	129	464	151	544

Supply air

RS14 + H

RS14 + H	Minimum		$\Delta p_t \geq 50$ Pa		$\Delta p_t \geq 50$ Pa	
	l/s	m ³ /h	30 dB(A)		35 dB(A)	
Size $\varnothing d$			l/s	m ³ /h	l/s	m ³ /h
mm						
125	26	93	28	101	34	122
160	33	118	53	191	63	227
200	57	204	65	234	80	288
250	71	254	89	320	107	385
315	95	342	-	-	148	533

Sound attenuation

Sound attenuation of the diffusers ΔL from duct to room, including end reflection - see tables below.

RS14-V + MBB

RS14-V + MBB		Centre frequency Hz							
duct	RS14-V	63	125	250	500	1K	2K	4K	8K
$\varnothing d_1$	$\varnothing d_2$								
100	160	20	16	5	19	20	19	18	21
125	160	16	13	9	20	18	18	19	20
125	200	14	12	6	17	16	16	18	19
160	160	17	16	10	24	20	20	21	21
160	200	15	15	7	22	21	19	20	21
160	250	15	14	5	20	16	16	17	19
200	200	14	11	7	18	21	17	20	18
200	250	13	9	5	17	18	16	18	17
200	315	13	8	3	15	17	15	17	16
250	250	15	8	7	18	18	18	18	19
250	315	15	7	6	16	16	17	17	18
315	315	8	11	8	16	18	17	17	22

RS14 + H

RS14 + H		Centre frequency Hz							
Size $\varnothing d$	mm	63	125	250	500	1K	2K	4K	8K
125		18	13	8	18	14	11	12	14
160		17	13	3	14	13	7	7	8
200		15	10	3	13	9	6	8	10
250		12	9	6	11	8	7	10	12
315		12	7	7	13	8	7	10	12

RS14 + R

RS14 + R		Mean frequency Hz							
Size-2	mm	63	125	250	500	1K	2K	4K	8K
200x100		19	14	9	6	5	3	3	4
300x100		16	11	5	5	6	5	3	4
400x100		13	8	2	3	4	5	4	5
500x100		12	7	2	4	2	5	5	5

Installation -and balancing instruction

For further information go to www.lindab.com and installation -and balancing instruction.

Versio

RS14

Technical data

Throw $l_{0,2}$

Throw $l_{0,2}$ [m] is specified at a terminal velocity of 0.2 m/s. The designation by the lines specifies the pattern of dispersal.

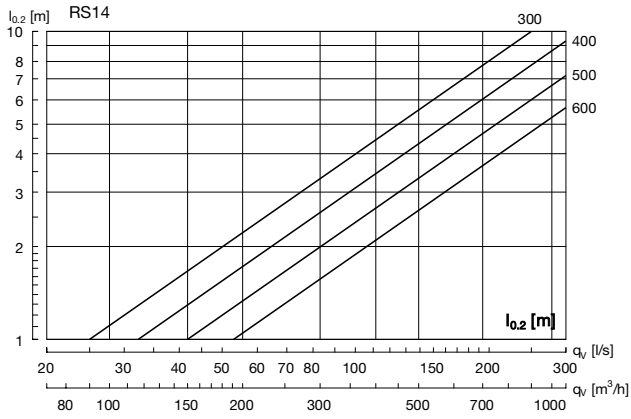

RS14-V without plenum box – Supply air

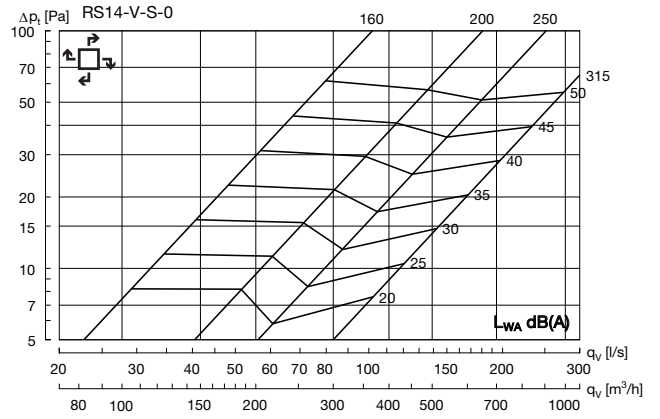

Versio

RS14

Technical data

RS14-V 160 + MBB - Supply air

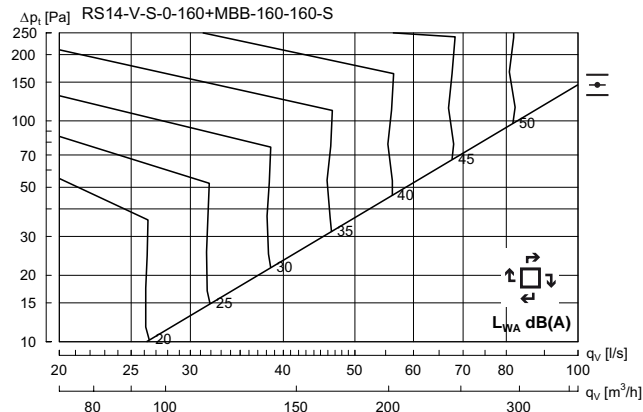

Hz	63	125	250	500	1K	2K	4K	8K
K_{ok}	8	2	-1	1	-7	-17	-26	-36

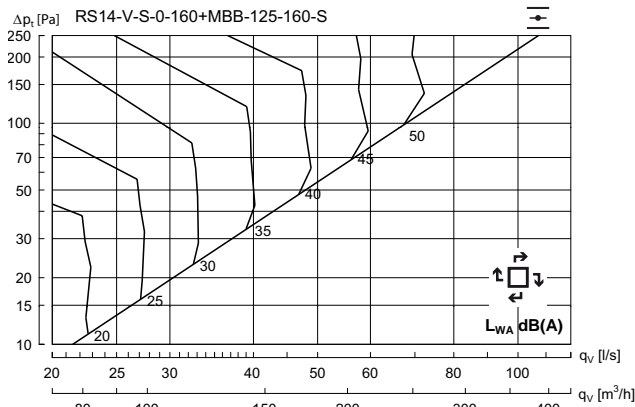

Hz	63	125	250	500	1K	2K	4K	8K
K_{ok}	10	4	-1	1	-7	-17	-24	-29

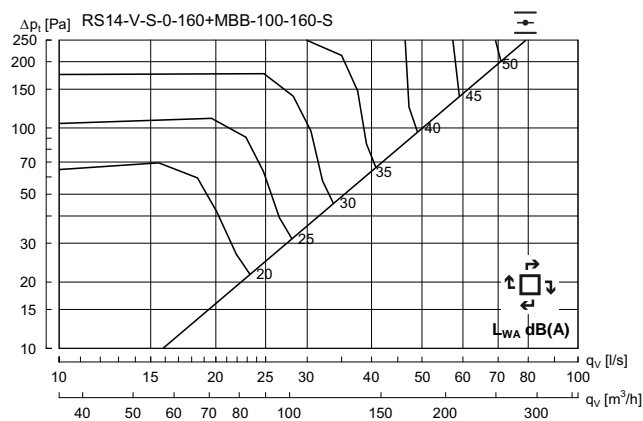

Hz	63	125	250	500	1K	2K	4K	8K
K_{ok}	10	4	2	-1	-7	-13	-18	-22

RS14-V 200 + MBB - Supply air

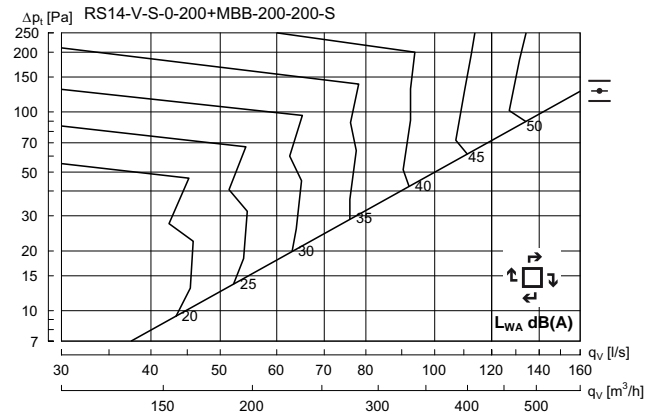

Hz	63	125	250	500	1K	2K	4K	8K
K_{ok}	11	0	-5	0	-4	-15	-26	-36

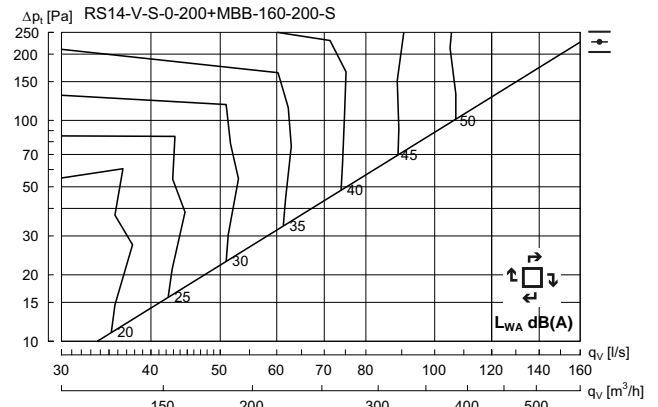

Hz	63	125	250	500	1K	2K	4K	8K
K_{ok}	11	2	-1	0	-6	-15	-24	-33

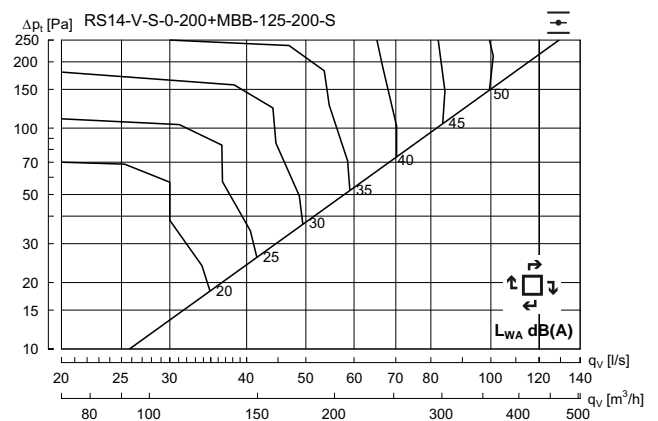

Hz	63	125	250	500	1K	2K	4K	8K
K_{ok}	10	4	2	-1	-7	-13	-18	-22

Versio

RS14

Technical data

RS14-V 250 + MBB - Supply air

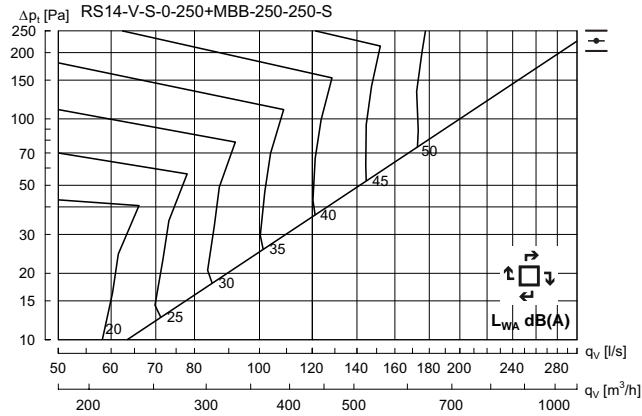

Hz	63	125	250	500	1K	2K	4K	8K
K_{ok}	8	-1	-6	1	-5	-18	-29	-40

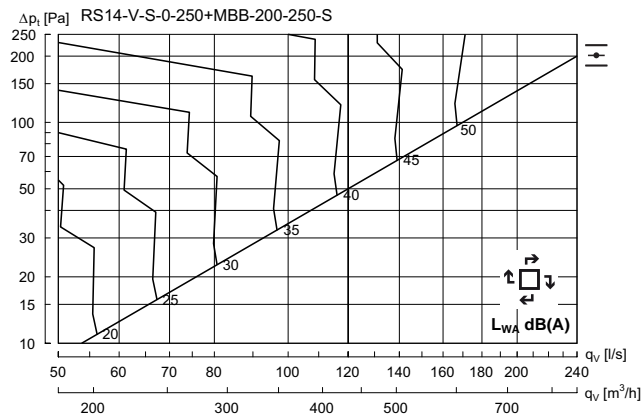

Hz	63	125	250	500	1K	2K	4K	8K
K_{ok}	9	2	-3	0	-5	-17	-26	-29

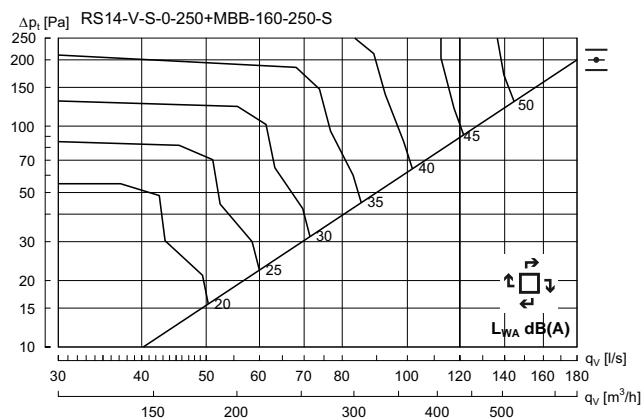

Hz	63	125	250	500	1K	2K	4K	8K
K_{ok}	13	5	-1	-1	-5	-14	-20	-26

RS14-V 315 + MBB - Supply air

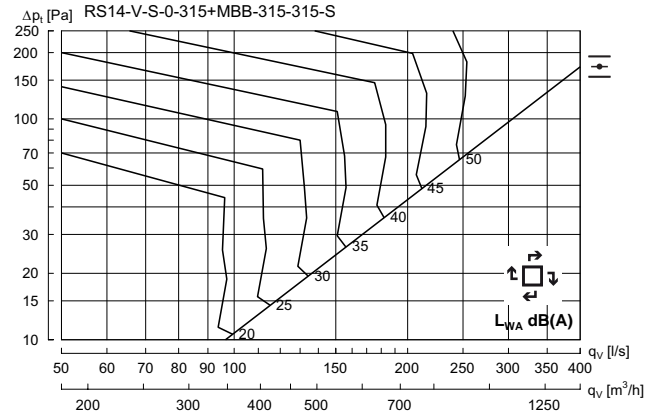

Hz	63	125	250	500	1K	2K	4K	8K
K_{ok}	11	-1	-3	0	-5	-17	-25	-28

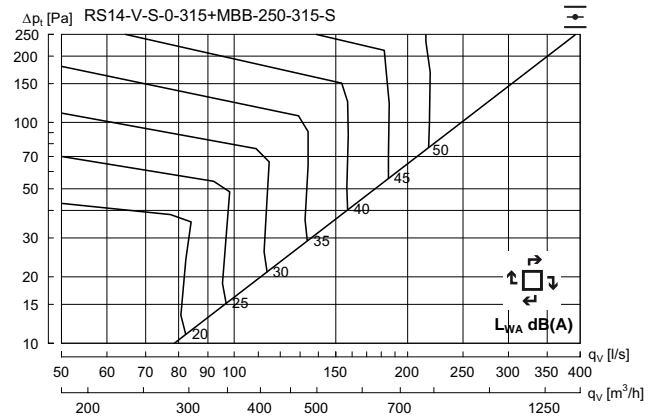

Hz	63	125	250	500	1K	2K	4K	8K
K_{ok}	12	2	-3	0	-5	-15	-22	-30

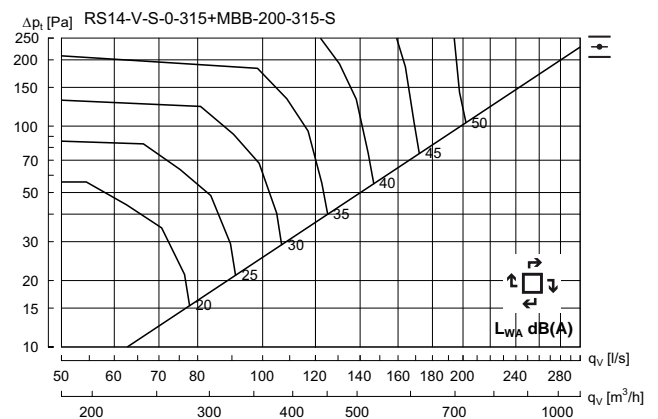

Hz	63	125	250	500	1K	2K	4K	8K
K_{ok}	13	4	-1	-1	-6	-14	-19	-25

Versio

RS14

Technical data

RS14-V without plenum box – Exhaust air

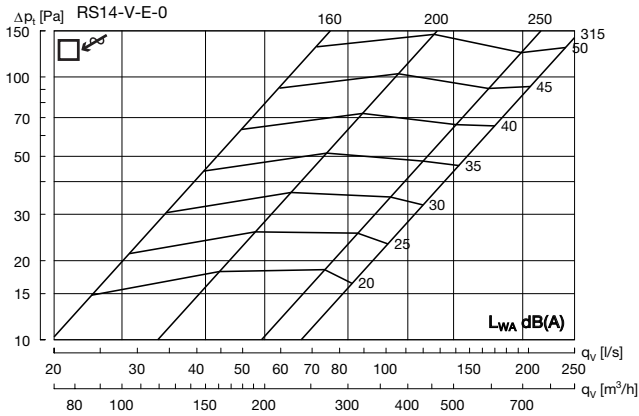

RS14-V 160 + MBB - Exhaust air

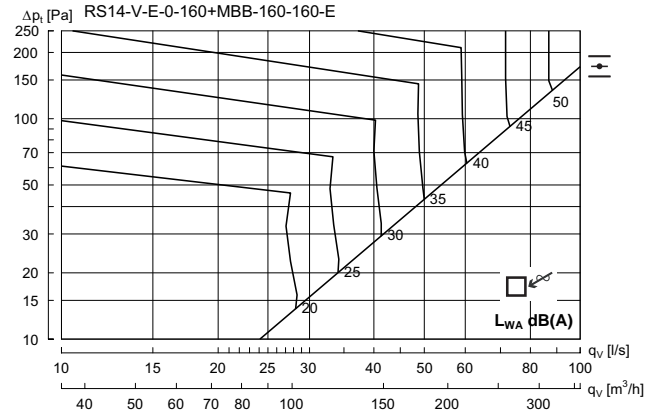

Hz	63	125	250	500	1K	2K	4K	8K
K_{ok}	12	2	-1	-1	-5	-13	-22	-31

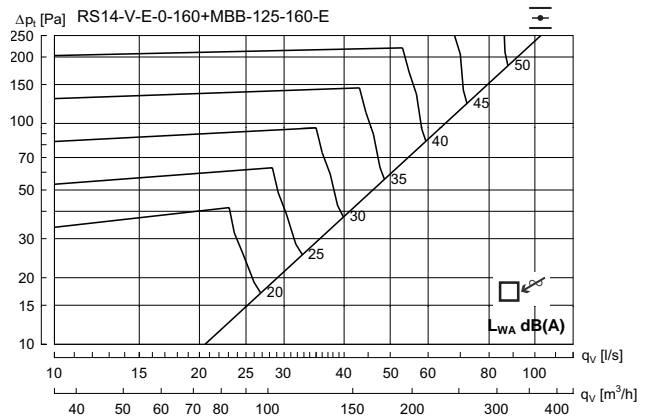

Hz	63	125	250	500	1K	2K	4K	8K
K_{ok}	11	4	-1	-1	-5	-13	-19	-27

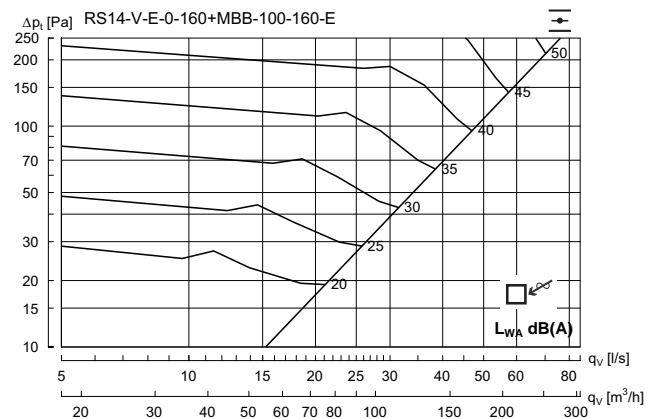

Hz	63	125	250	500	1K	2K	4K	8K
K_{ok}	11	4	4	-2	-9	-13	-17	-23

Versio

RS14

Technical data

RS14-V 200 + MBB - Exhaust air

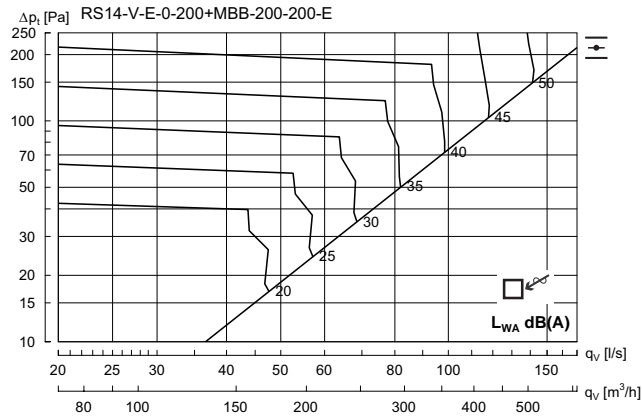

Hz	63	125	250	500	1K	2K	4K	8K
K_{ok}	13	4	-1	-1	-5	-12	-20	-28

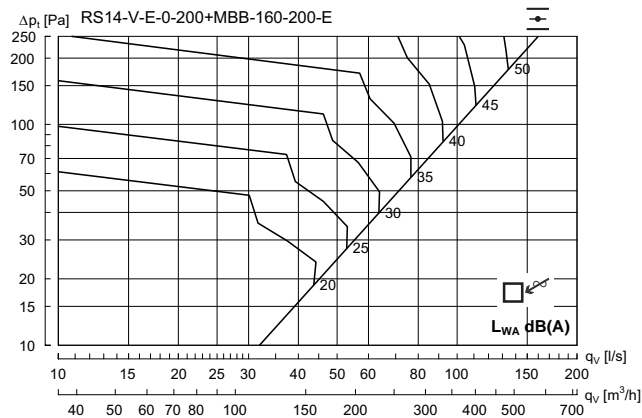

Hz	63	125	250	500	1K	2K	4K	8K
K_{ok}	16	6	0	-2	-6	-12	-18	-25

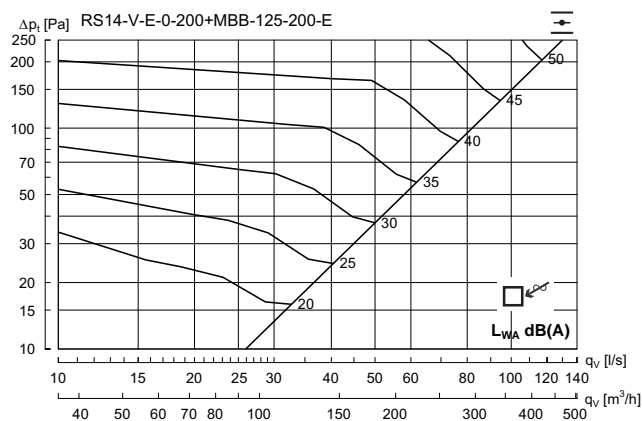

Hz	63	125	250	500	1K	2K	4K	8K
K_{ok}	11	4	2	-1	-7	-12	-16	-23

RS14-V 250 + MBB - Exhaust air

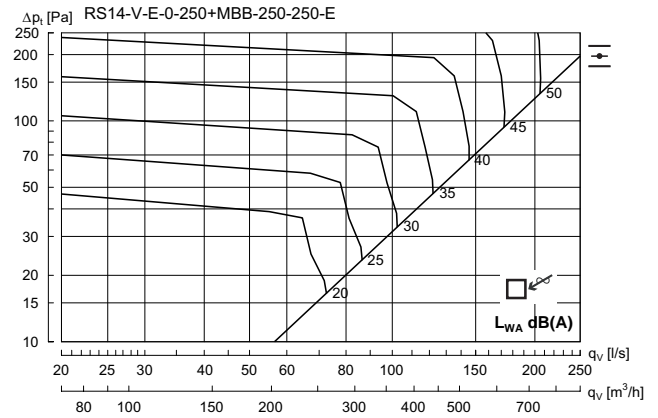

Hz	63	125	250	500	1K	2K	4K	8K
K_{ok}	8	5	0	-1	-5	-11	-20	-28

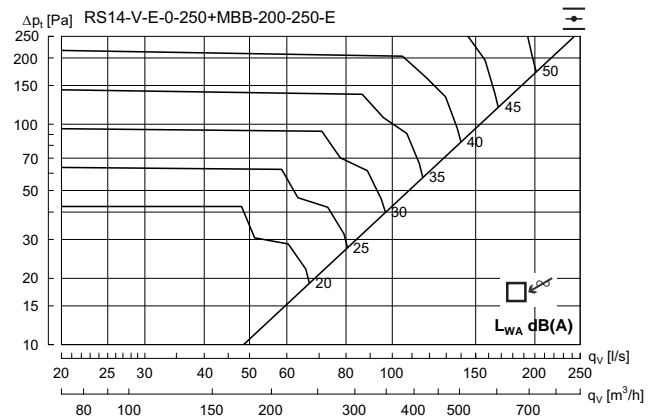

Hz	63	125	250	500	1K	2K	4K	8K
K_{ok}	14	5	1	-2	-5	-11	-19	-26

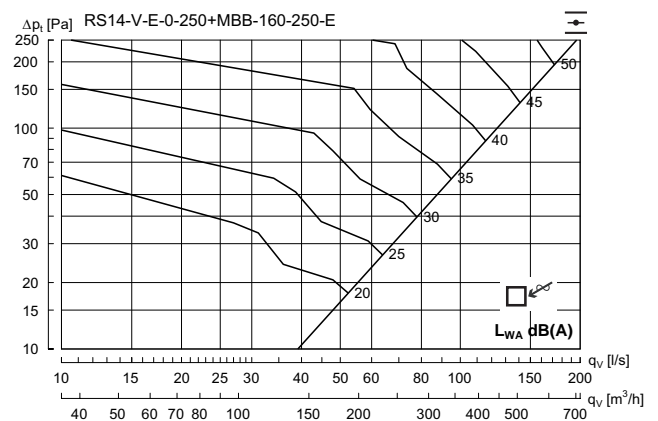

Hz	63	125	250	500	1K	2K	4K	8K
K_{ok}	15	7	1	-2	-7	-11	-17	-22

Versio

RS14

Technical data

RS14-V 315 + MBB - Exhaust air

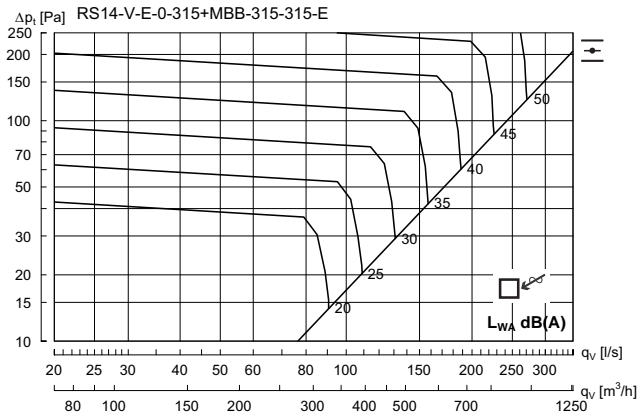

Hz	63	125	250	500	1K	2K	4K	8K
K_{ok}	11	4	1	-2	-5	-13	-22	-32

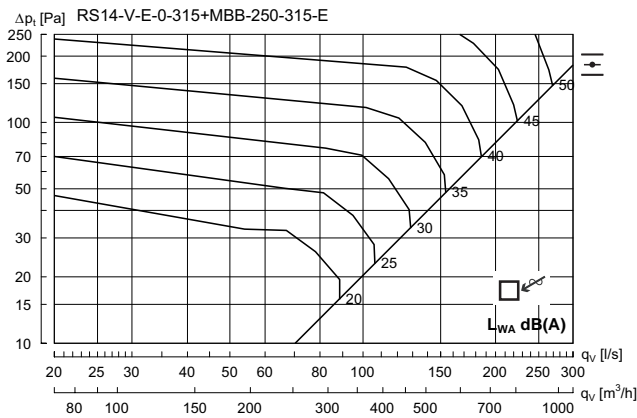

Hz	63	125	250	500	1K	2K	4K	8K
K_{ok}	10	6	2	-2	-5	-12	-19	-27

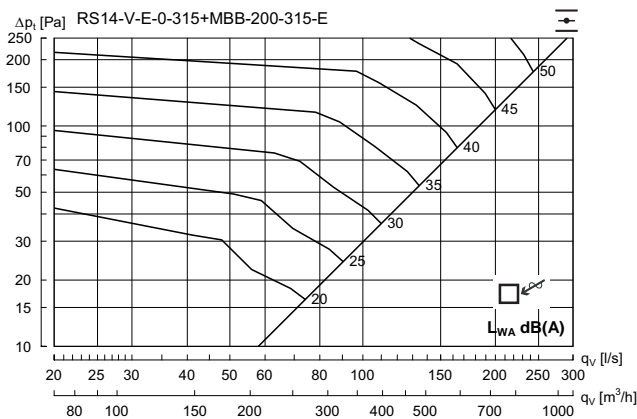

Hz	63	125	250	500	1K	2K	4K	8K
K_{ok}	14	5	2	-2	-6	-11	-16	-24

- 1
- 2
- 3
- 4
- 5
- 6
- 7
- 8
- 9
- 10
- 11
- 12
- 13
- 14
- 15
- 16
- 17
- 18

Versio

RS14

Technical data

RS14 + H - Supply air

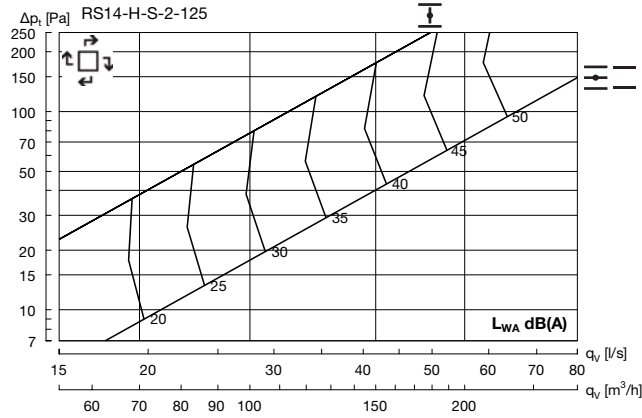

Hz	63	125	250	500	1K	2K	4K	8K
K_{ok}	14	8	5	-3	-10	-17	-23	-28

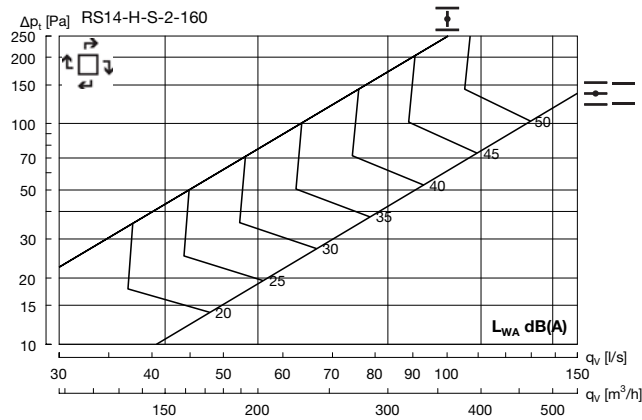

Hz	63	125	250	500	1K	2K	4K	8K
K_{ok}	2	5	5	-3	-7	-14	-20	-26

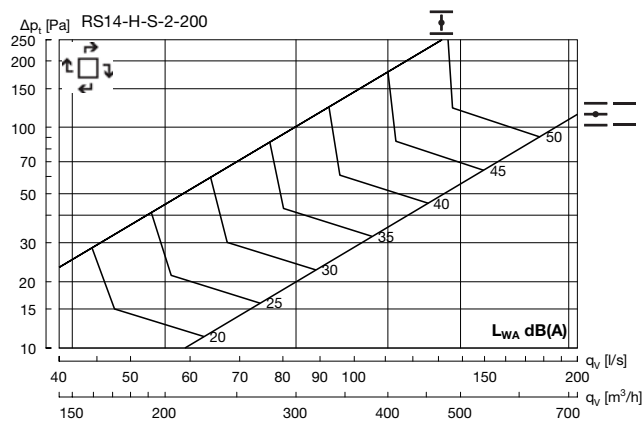

Hz	63	125	250	500	1K	2K	4K	8K
K_{ok}	10	7	2	-2	-6	-14	-21	-29

RS14 + H - Supply air

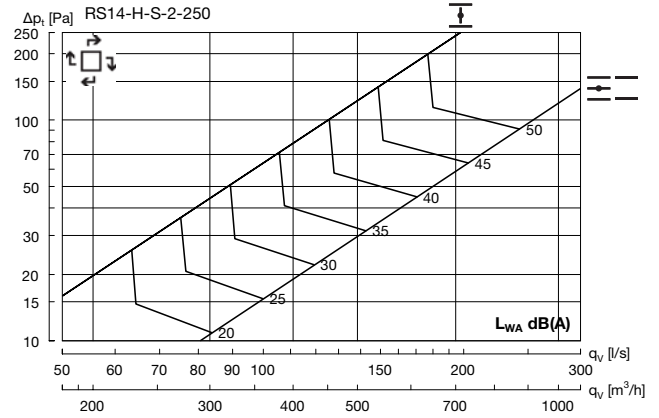

Hz	63	125	250	500	1K	2K	4K	8K
K_{ok}	5	7	3	-1	-7	-16	-23	-31

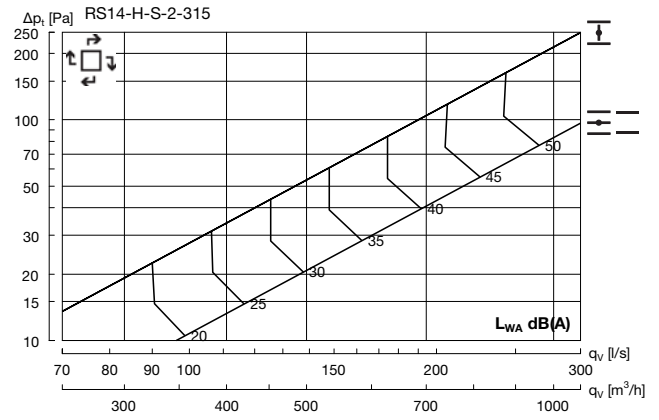

Hz	63	125	250	500	1K	2K	4K	8K
K_{ok}	7	7	2	-1	-7	-16	-25	-35

Versio

RS14

Technical data

RS14 + H - Exhaust air

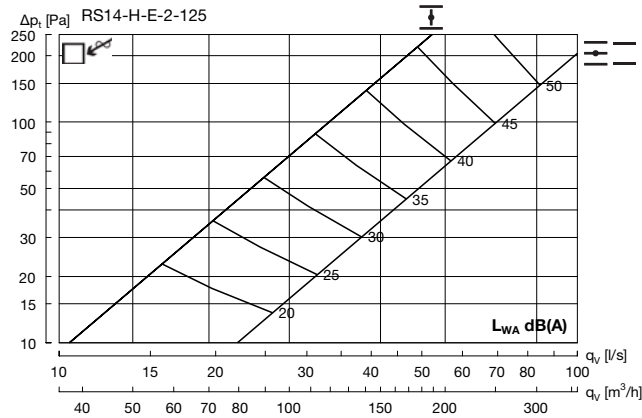

Hz	63	125	250	500	1K	2K	4K	8K
K_{ok}	3	7	3	-1	-8	-14	-19	-26

RS14 + H - Exhaust air

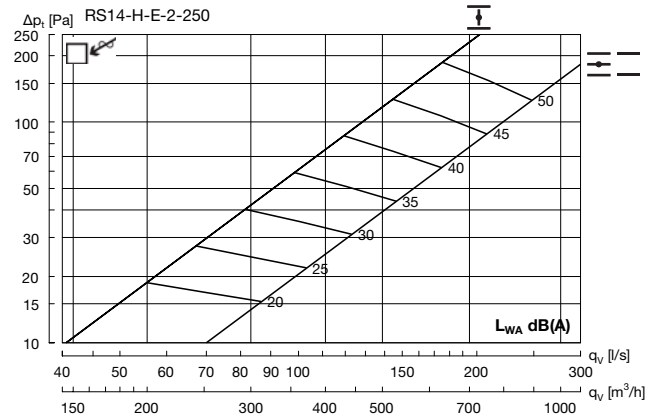

Hz	63	125	250	500	1K	2K	4K	8K
K_{ok}	5	7	3	-2	-7	-13	-21	-31

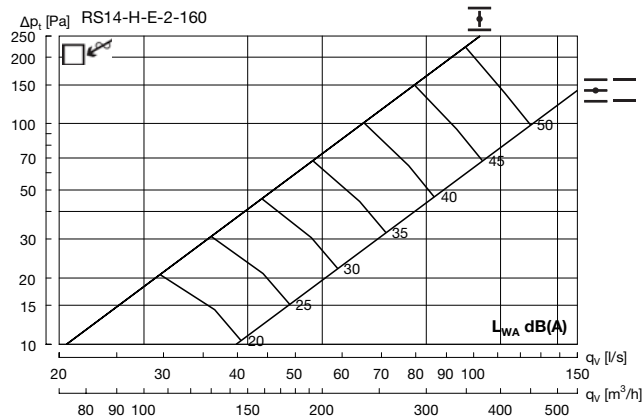

Hz	63	125	250	500	1K	2K	4K	8K
K_{ok}	2	6	5	-3	-8	-14	-22	-31

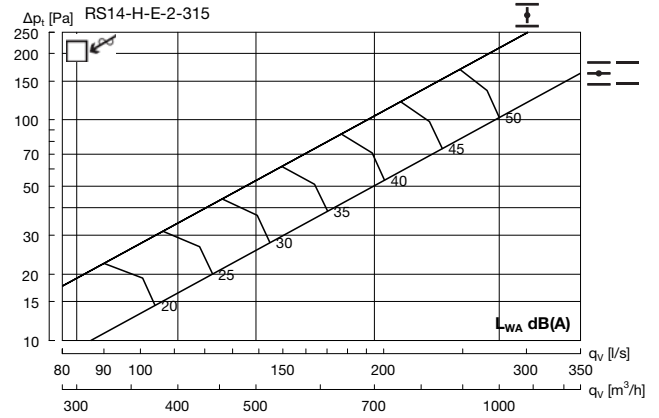

Hz	63	125	250	500	1K	2K	4K	8K
K_{ok}	7	7	2	-2	-6	-14	-24	-35

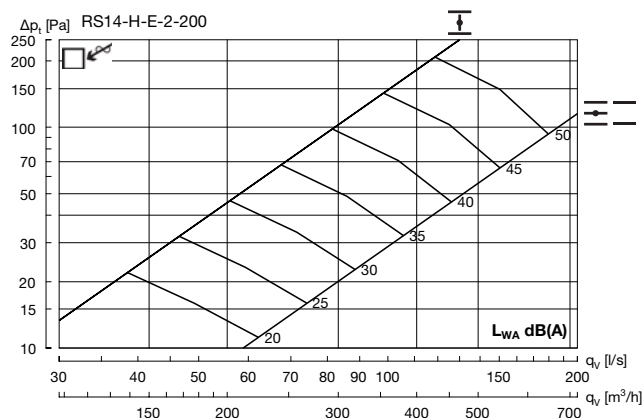

Hz	63	125	250	500	1K	2K	4K	8K
K_{ok}	7	7	4	-3	-7	-13	-20	-25



Versio

RS14

Technical data

RS14 + R - Supply air

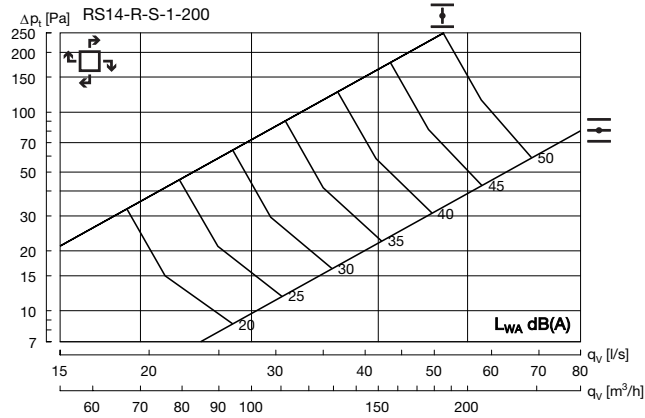

Hz	63	125	250	500	1K	2K	4K	8K
K_{ok}	6	-1	3	-1	-7	-12	-25	-33

RS14 + R - Supply air

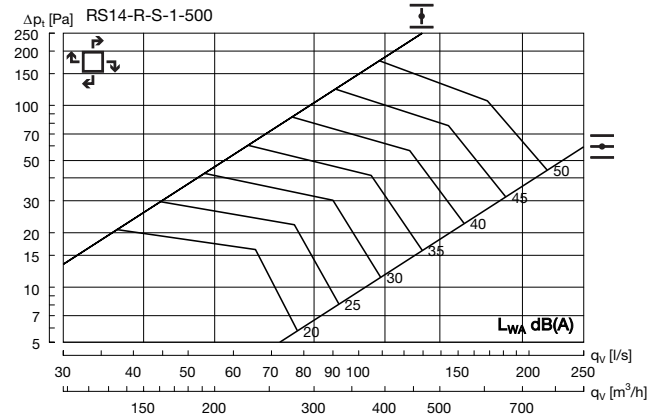

Hz	63	125	250	500	1K	2K	4K	8K
K_{ok}	3	-1	3	-1	-7	-11	-19	-31

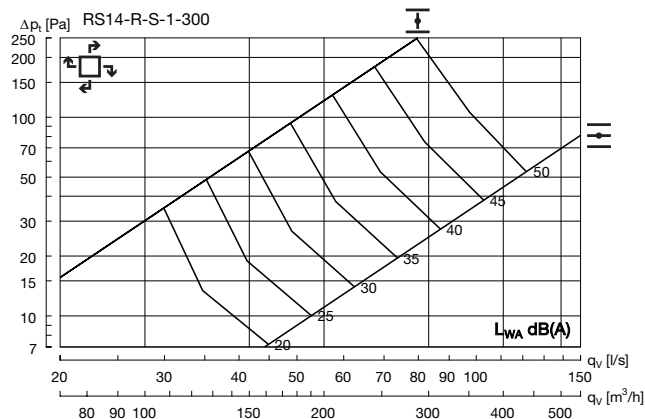

Hz	63	125	250	500	1K	2K	4K	8K
K_{ok}	7	-1	4	-1	-8	-14	-22	-31

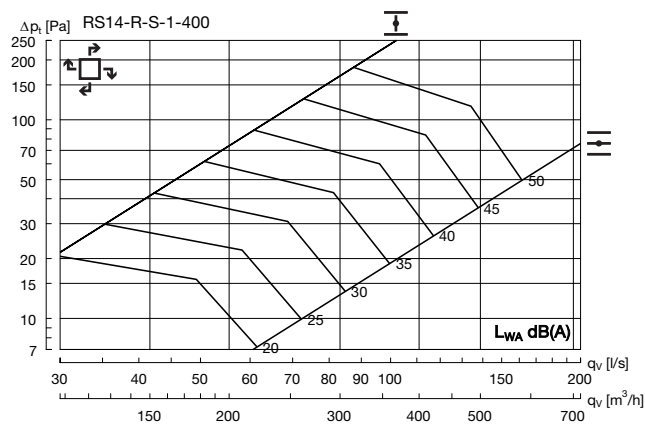

Hz	63	125	250	500	1K	2K	4K	8K
K_{ok}	-2	-1	3	-1	-6	-11	-20	-32

Versio

RS14

Technical data

RS14 + R - Exhaust air

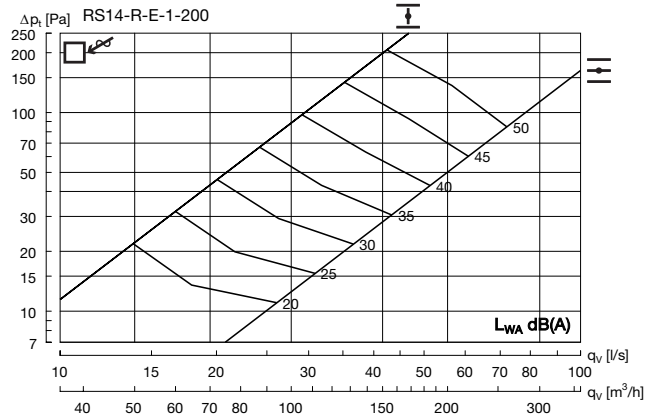

Hz	63	125	250	500	1K	2K	4K	8K
K_{sk}	7	-1	4	-2	-8	-10	-18	-25

RS14 + R - Exhaust air

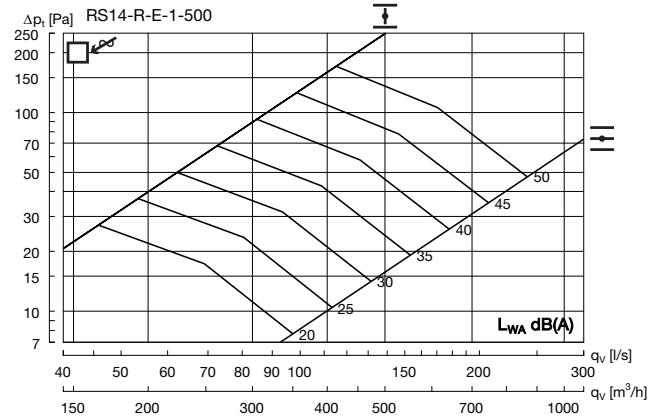

Hz	63	125	250	500	1K	2K	4K	8K
K_{sk}	1	1	1	-2	-6	-9	-16	-25

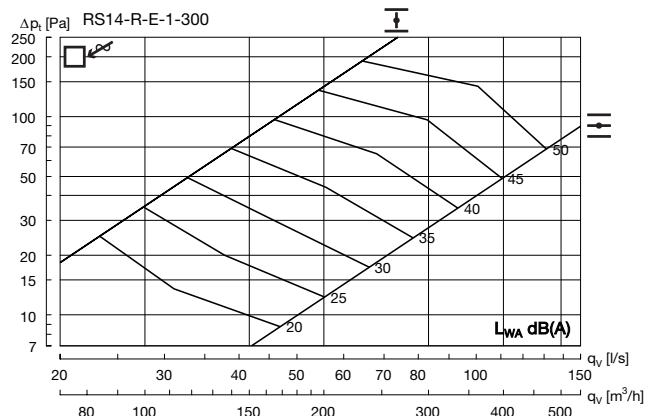

Hz	63	125	250	500	1K	2K	4K	8K
K_{sk}	6	1	4	-2	-7	-10	-17	-25

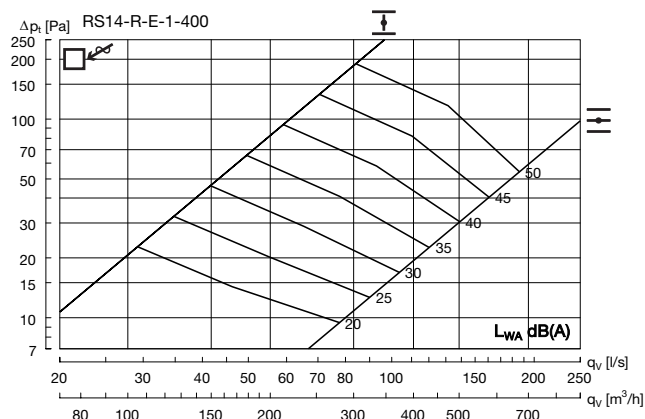

Hz	63	125	250	500	1K	2K	4K	8K
K_{sk}	2	0	2	-2	-5	-10	-16	-24



Versio

RS15



RS15 with grille box type V

Description

RS15 is a square swirl diffuser with adjustable bars that can be used for both supply and exhaust air. The swirl pattern ensures high induction and a large dynamic range. It is therefore ideal for the horizontal supply of very cold air. The diffuser can also be set to a vertical supply air pattern, enabling supply of heated air. The diffuser is supplied as standard with inward swirl. For exhaust, the diffuser is supplied as standard without bars

- Large dynamic range
- High induction
- Ideal for the supply of very cold air
- Adjustable for horizontal or vertical supply air pattern
- Can be used for both supply air and exhaust

Order code

Product	RS	15	b	c	d	eee	f
Type	RS						
Design	15						
Box type	V - H - R						
Functional use	S = Supply air E = Exhaust						
Damper	0 = No damper (Box : H, V) 1 = Damper (Box : H, R) 2 = Damper / Meas.outlets (Box : H)						
Connection dim.	Ø200-315 (Box : V) Ø160-315 (Box : H) 300x100 - 500x100 (Box : R)						
Ceiling system	1 - 14	Go to chapter Ceiling tile adaption					

Example: RS-15-V-S-0-200-1



RS15 with plenum box type H

Dimensions

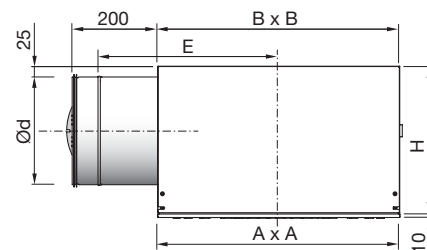

RS15-H	A	B	H	E	Weight	
Ød	Pattern	mm	mm	mm	kg	
160	400	*-	380	250	350	5.9
200	500	*-	460	290	390	8.5
250	600	*-	560	340	420	12.3
315	600	*-	560	405	420	13.1

* Face plate dimension A x A depends on ceiling system. See "**Ceiling adjustment**" for detailed dimensions. For further details on plenum box - see "**Plenum boxes**".

Maintenance

The face plate can be removed to enable cleaning of internal parts or to gain access to the duct or box. The visible parts of the diffuser can be wiped with a damp cloth.

Materials and finish

Grille box/plenum box:

Material: Galvanised steel

Face plate:

Material: Galvanised steel

Bars: Black ABS-plastic

Standard finish: Powder-coated

Standard colour: RAL 9010, gloss 30

The diffuser is available in other colours. Please contact Lindab's sales department for further information.

Versio

RS15

Accessories

Extension piece

MBZ



Order code

Product MBZ aaa
 Type _____
 Size _____

Example: MBZ-200

Mounting bracket

PBB



Suspension

MHS



Order code

Product _____
 Type _____ aaa

Example: MHS

Plenum box

MBB



RS15-V + MBB

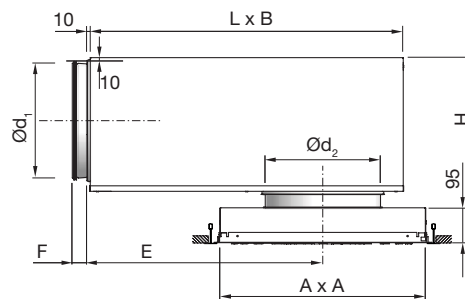

RS15-V + MBB		Pattern	B mm	E mm	F mm	H* mm	L mm
duct Ød ₁ mm	RS15-V Ød ₂ mm						
125	200	400	310	262	50	280 - 320	376
160	200	400	380	323	50	314 - 354	459
160	250	500	380	323	50	314 - 354	459
200	200	400	460	396	70	355 - 395	565
200	250	500	460	396	70	355 - 395	565
200	315	600	460	396	70	355 - 395	565
250	250	500	540	486	70	405 - 445	698
250	315	600	540	486	70	405 - 445	698
315	315	600	540	646	70	470 - 510	858

* Using accessory MBZ the H dimension will increase:

Ød₂ = 200 mm => H +40 mm

Ød₂ = 250 - 315 mm => H +60 mm

Order code

Product MBB aaa bbb c
 Type _____
 MBB _____
 Duct connection Ød₁ _____
 Ø125-315 _____
 Diffuser dimension Ød₂ _____
 Ø200-315 _____
 Functional use _____
 S = Supply air
 E = Exhaust

Example: RS-15-V-S-200-1+MBB-200-200-S

Versio

RS15

Technical data

Capacity

Air flow q_v [l/s] and [m³/h], total pressure Δp_t [Pa], throw $l_{0,2}$ [m] and sound power level L_{WA} [dB(A)] can be seen in the diagrams.

Frequency-related sound effect level

The sound effect level in the frequency band is defined as $L_{WA}+K_{ok}$. K_{ok} values are specified in charts beneath the diagrams on the following pages.

Quick selection, supply air

RS15-V + MBB

RS15-V + MBB		$\Delta p_t \geq 50$ Pa		$\Delta p_t \geq 50$ Pa	
duct	RS15-V	30 dB(A)		35 dB(A)	
$\varnothing d_1$	$\varnothing d_2$	l/s	m ³ /h	l/s	m ³ /h
125	200	53	191	63	227
160	200	56	202	67	241
160	250	72	259	91	328
200	200	60	216	73	263
200	250	84	302	102	367
200	315	94	338	119	428
250	250	94	338	112	403
250	315	107	385	128	461
315	315	123	443	144	518

Supply air

RS15 + H

RS15 + H		Minimum		$\Delta p_t \geq 50$ Pa		$\Delta p_t \geq 50$ Pa	
Size $\varnothing d$	mm	l/s	m ³ /h	30 dB(A)		35 dB(A)	
mm		l/s	m ³ /h	l/s	m ³ /h	l/s	m ³ /h
160	33	118	53	191	63	227	
200	57	204	65	234	80	288	
250	71	254	89	320	107	385	
315	95	342	-	-	148	533	

Sound attenuation

Sound attenuation of the diffusers ΔL from duct to room, including end reflection - see table below.

RS15-V + MBB

RS15-V + MBB		Centre frequency Hz							
duct	RS15-V	63	125	250	500	1K	2K	4K	8K
$\varnothing d_1$	$\varnothing d_2$								
125	200	14	13	6	16	18	17	18	19
160	200	15	15	8	22	21	20	20	20
160	250	15	14	4	20	17	18	18	20
200	200	14	11	8	17	21	18	21	18
200	250	14	9	5	17	18	16	18	17
200	315	12	9	4	16	17	16	17	16
250	250	15	9	8	19	19	18	18	18
250	315	16	7	5	15	16	17	17	18
315	315	10	10	8	16	18	17	17	23

RS15 + H

RS15 + H		Centre frequency Hz							
Size $\varnothing d$	mm	63	125	250	500	1K	2K	4K	8K
160		17	12	5	15	14	10	9	9
200	14	8	4	13	10	7	8	11	
250	12	8	6	9	7	7	8	10	
315	12	6	7	12	6	6	8	10	

RS15 + R

RS15 + R		Mean frequency Hz							
Size-2	mm	63	125	250	500	1K	2K	4K	8K
300x100		16	11	5	5	6	5	3	4
400x100	13	8	2	3	4	5	4	5	
500x100	12	7	2	4	2	5	5	5	

Installation -and balancing instruction

For further information go to www.lindab.com and installation -and balancing instruction.

Versio

RS15

Technical data

Throw $l_{0.2}$

Throw $l_{0.2}$ [m] is specified at a terminal velocity of 0.2 m/s. The designation by the lines specifies the pattern of dispersal.

Inward swirl

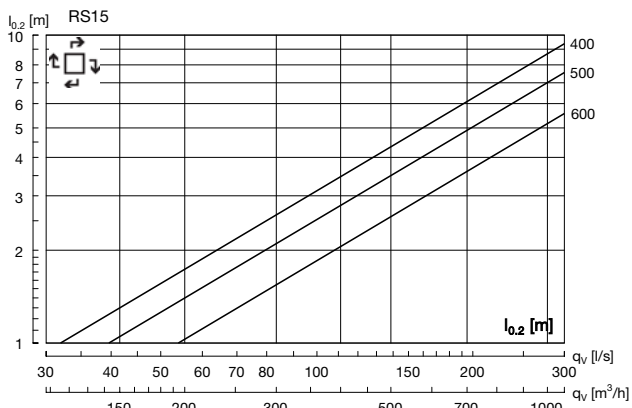

Outward swirl

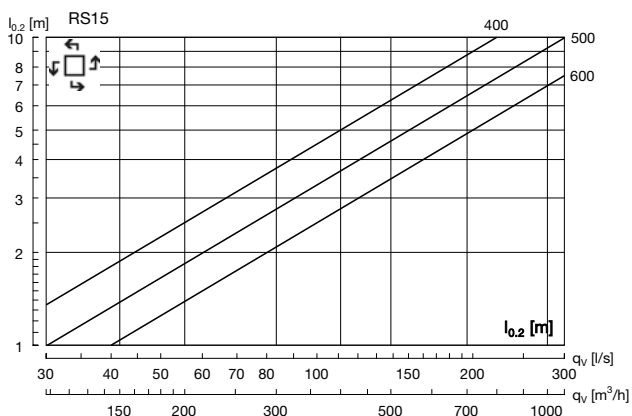

Horizontal and vertical bars

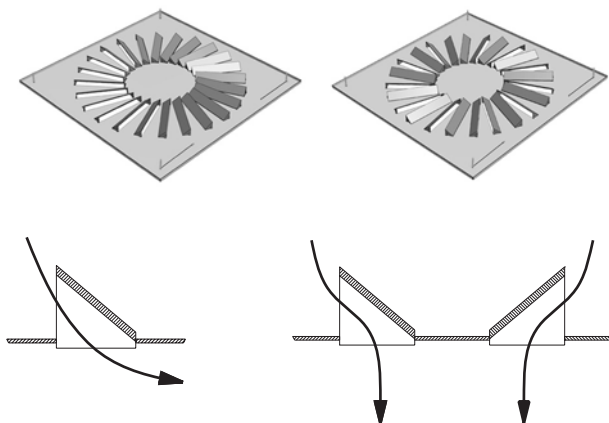

Throws/turning points

Throw $l_{0.2}$ [m] can be seen in the diagram. The throw applies for isothermal air at a terminal velocity of 0.2 m/s. Turning point $l_{0.0}$ (m) can be seen in the diagram for heated air, +5 K and +10 K respectively. The designation by the lines specifies the pattern of dispersal.

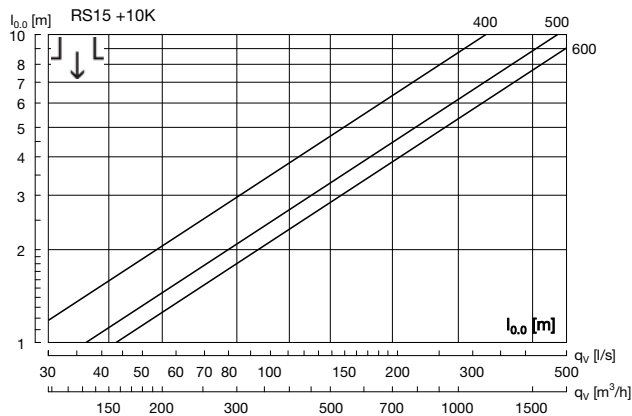
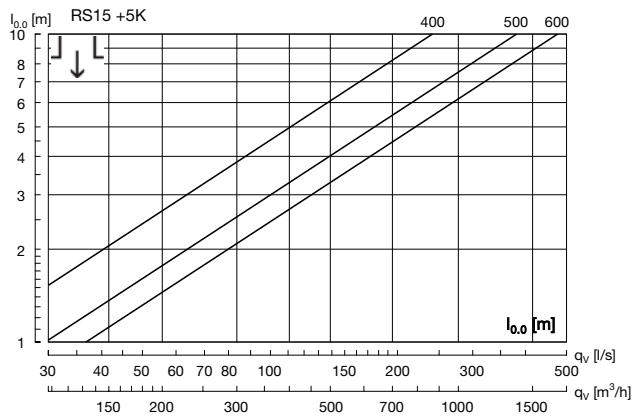
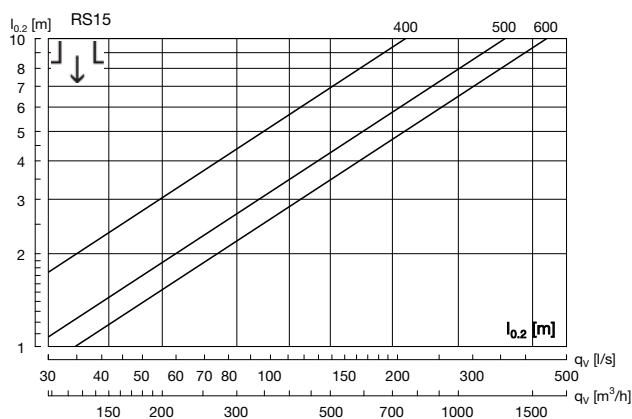

Versio

RS15

Technical data

RS15-V without plenum box - Supply air

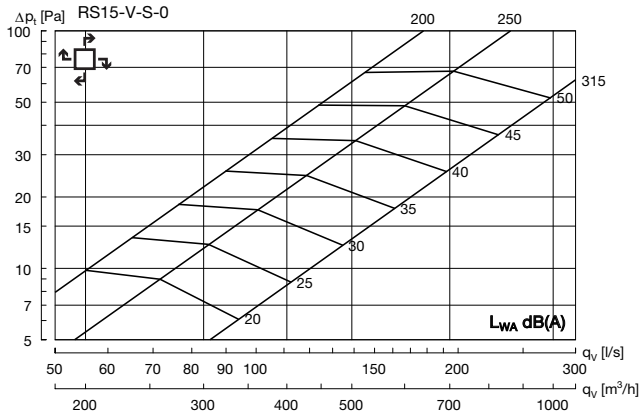

RS15-V 200 + MBB - Supply air

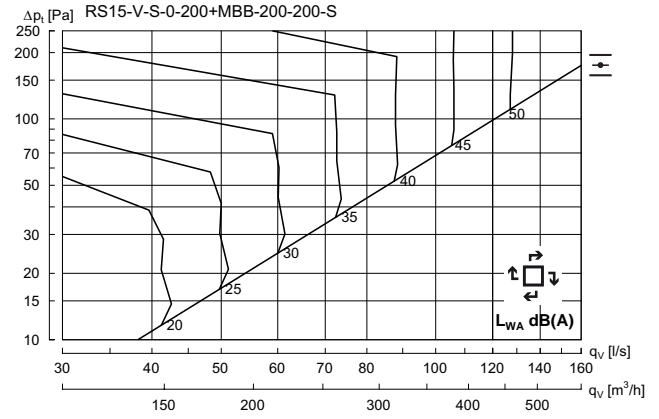

Hz	63	125	250	500	1K	2K	4K	8K
K_{ok}	13	2	-4	0	-5	-14	-21	-29

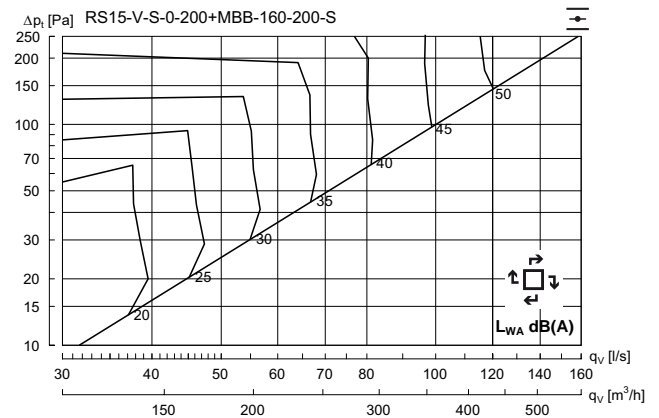

Hz	63	125	250	500	1K	2K	4K	8K
K_{ok}	11	4	-2	-1	-5	-13	-19	-27

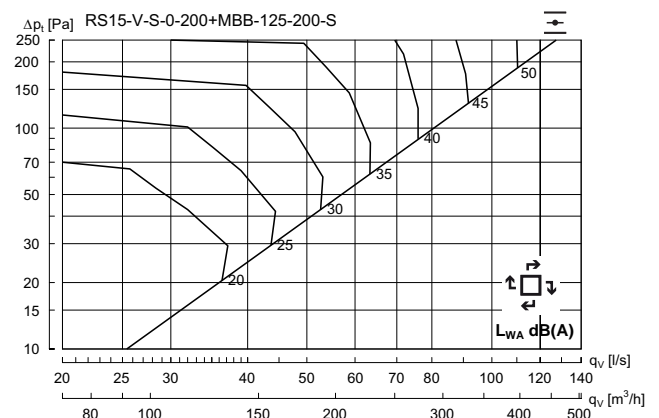

Hz	63	125	250	500	1K	2K	4K	8K
K_{ok}	12	5	1	-1	-6	-11	-16	-22



Versio

RS15

Technical data

RS15-V 250 + MBB - Supply air

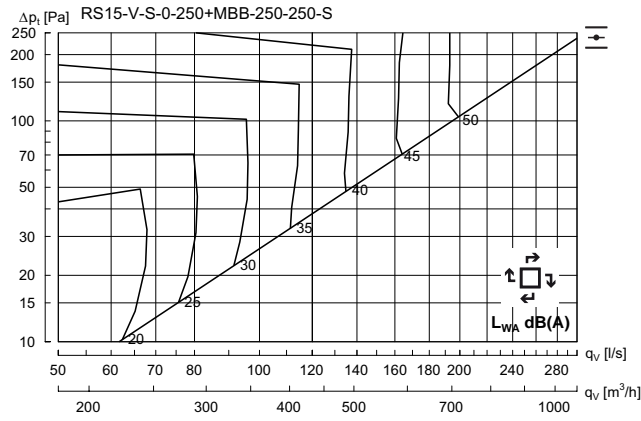

Hz	63	125	250	500	1K	2K	4K	8K
K_{ok}	10	2	-3	0	-5	-14	-20	-30

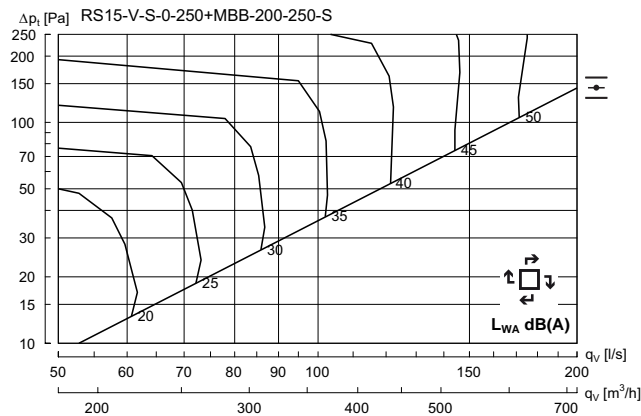

Hz	63	125	250	500	1K	2K	4K	8K
K_{ok}	11	4	-1	0	-7	-14	-22	-30

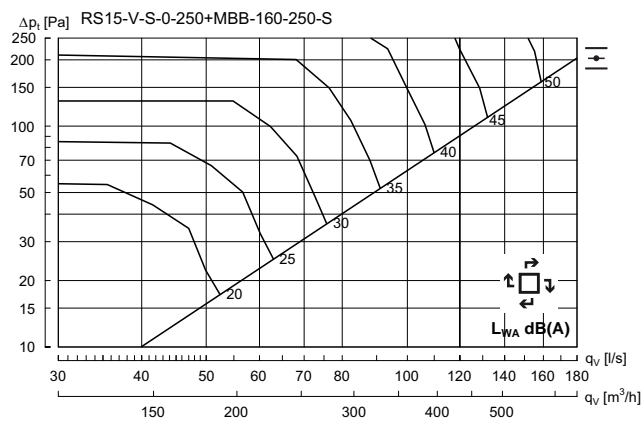

Hz	63	125	250	500	1K	2K	4K	8K
K_{ok}	12	4	0	-2	-5	-11	-18	-24

RS15-V 315 + MBB - Supply air

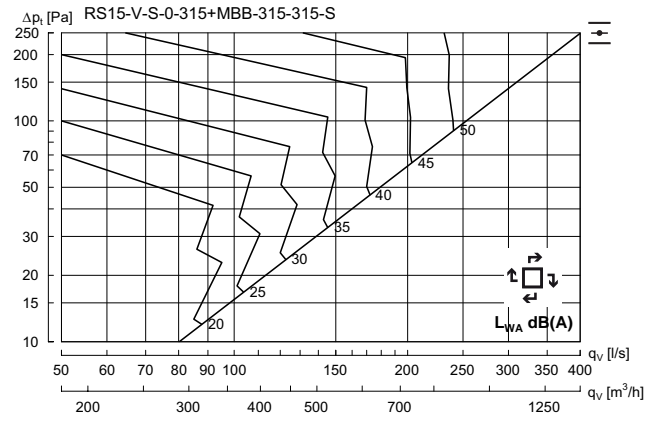

Hz	63	125	250	500	1K	2K	4K	8K
K_{ok}	9	3	0	0	-6	-13	-20	-30

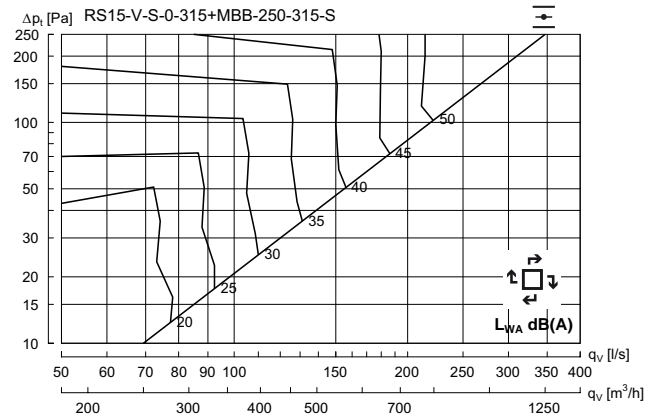

Hz	63	125	250	500	1K	2K	4K	8K
K_{ok}	10	4	-1	-1	-5	-13	-19	-28

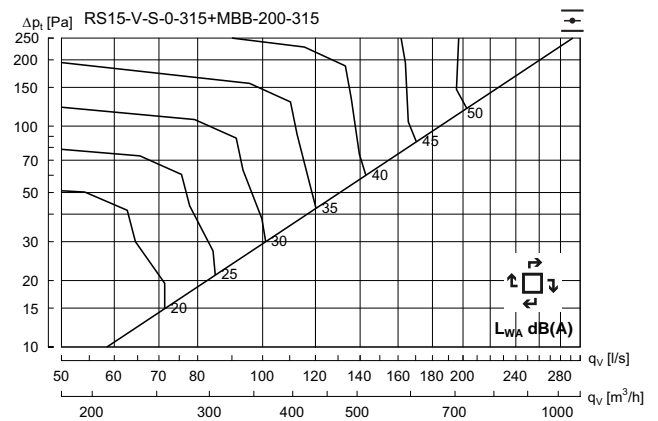

Hz	63	125	250	500	1K	2K	4K	8K
K_{ok}	10	6	0	-1	-6	-12	-18	-27

Versio

RS15

Technical data

RS15-V without plenum box - Exhaust air

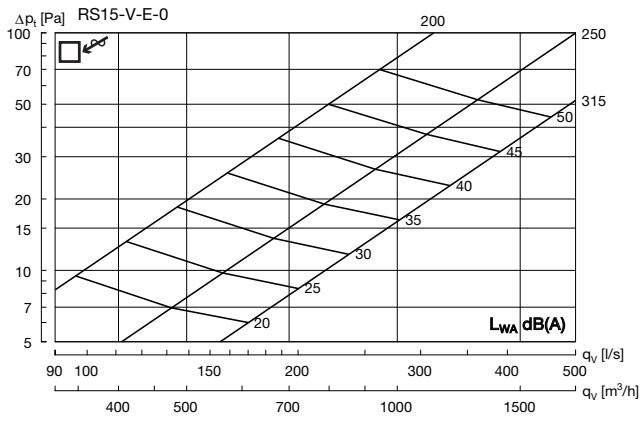

RS15-V 200 + MBB - Exhaust air

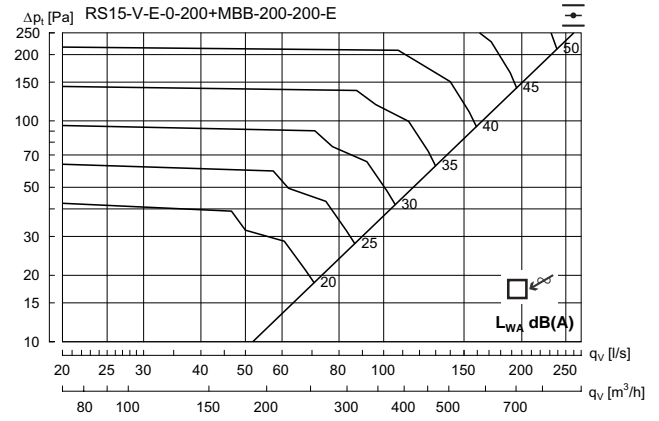

Hz	63	125	250	500	1K	2K	4K	8K
K_{ok}	14	5	1	-3	-6	-10	-15	-23

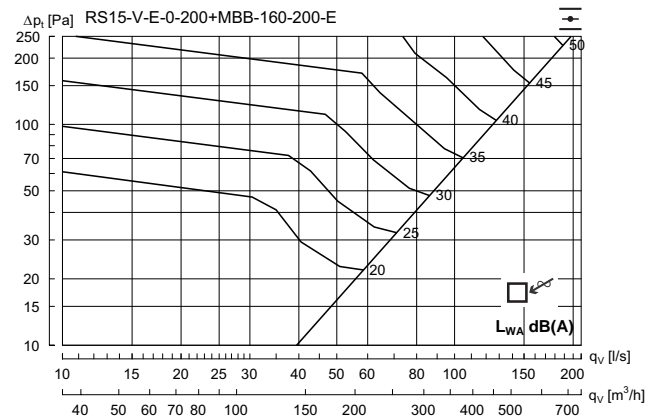

Hz	63	125	250	500	1K	2K	4K	8K
K_{ok}	14	6	0	-2	-7	-9	-15	-19

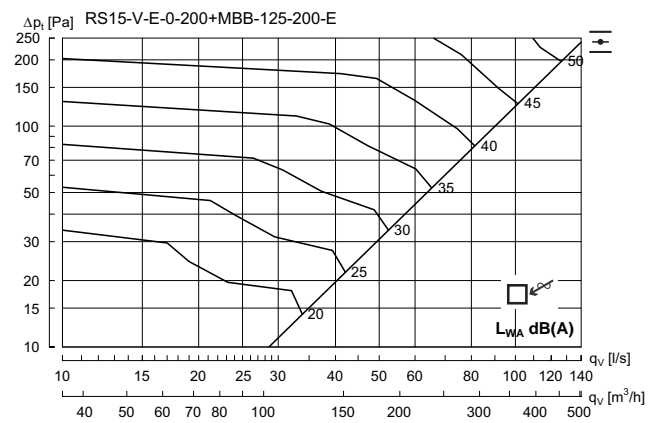

Hz	63	125	250	500	1K	2K	4K	8K
K_{ok}	13	4	1	-1	-7	-11	-15	-22

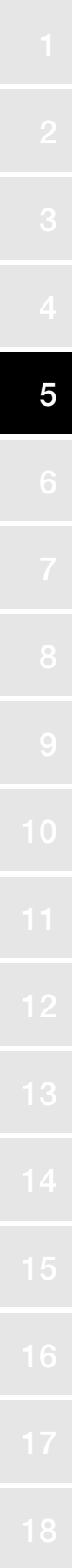

Versio

RS15

Technical data

RS15-V 250 + MBB - Exhaust air

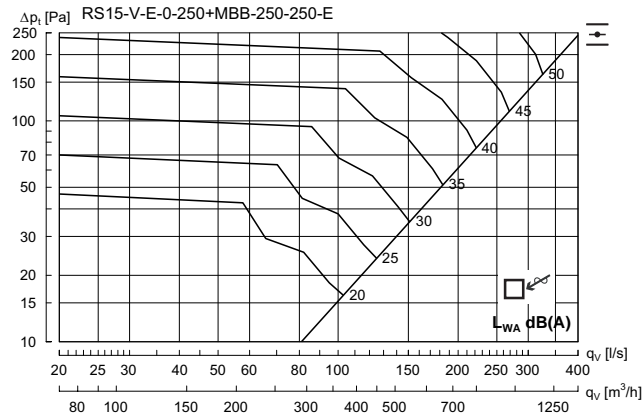

Hz	63	125	250	500	1K	2K	4K	8K
K_{ok}	10	6	3	-4	-6	-10	-16	-24

RS15-V 315 + MBB - Exhaust air

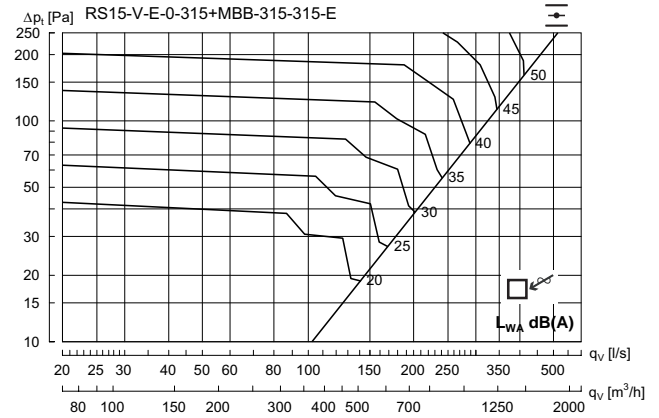

Hz	63	125	250	500	1K	2K	4K	8K
K_{ok}	12	6	3	-3	-6	-11	-16	-26

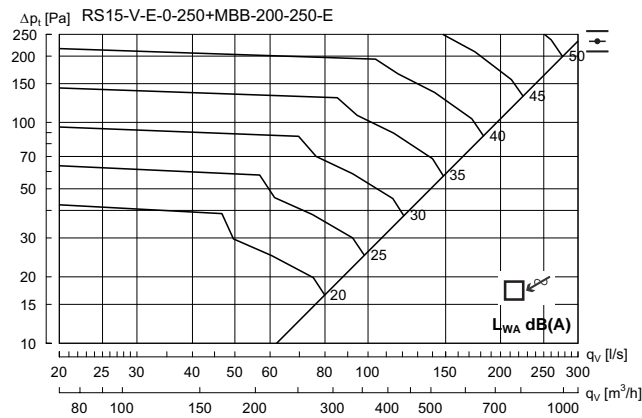

Hz	63	125	250	500	1K	2K	4K	8K
K_{ok}	14	5	1	-3	-6	-10	-13	-21

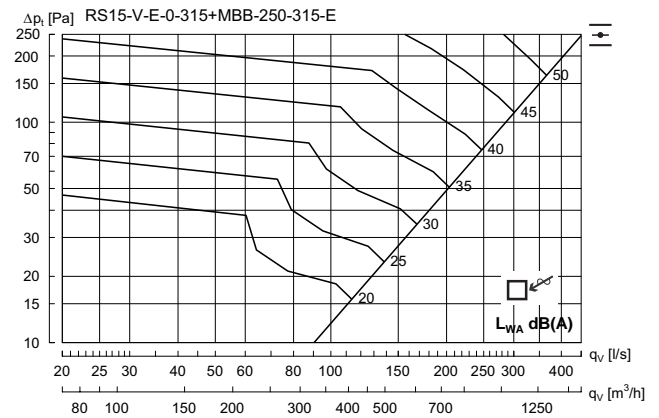

Hz	63	125	250	500	1K	2K	4K	8K
K_{ok}	11	6	2	-4	-6	-10	-16	-23

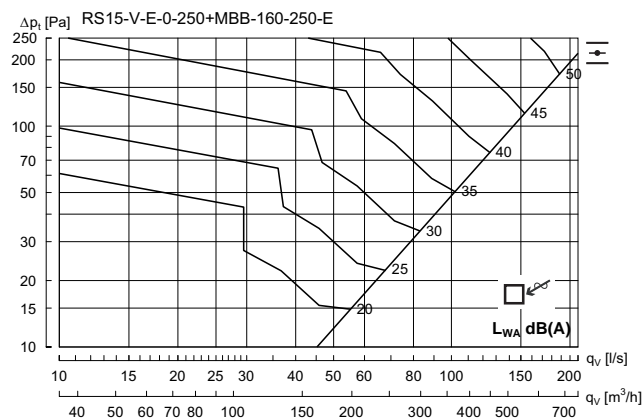

Hz	63	125	250	500	1K	2K	4K	8K
K_{ok}	15	7	1	-3	-6	-10	-16	-19

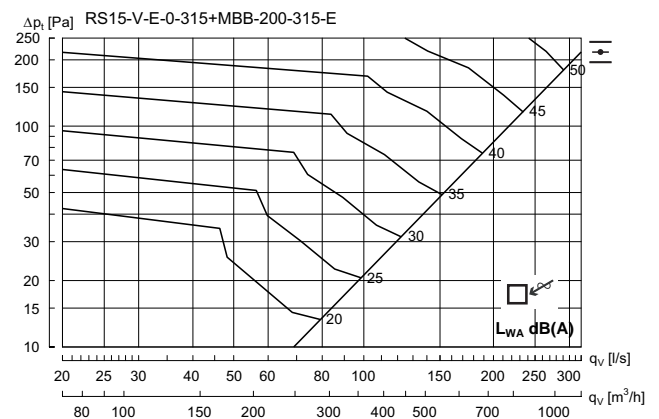

Hz	63	125	250	500	1K	2K	4K	8K
K_{ok}	14	5	1	-3	-6	-10	-14	-22

Versio

RS15

Technical data

RS15 + H - Supply air

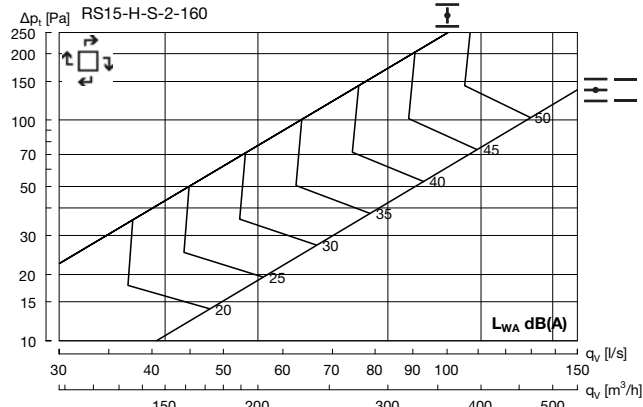

Hz	63	125	250	500	1K	2K	4K	8K
K_{ok}	2	5	5	-3	-7	-14	-20	-26

RS15 + H - Supply air

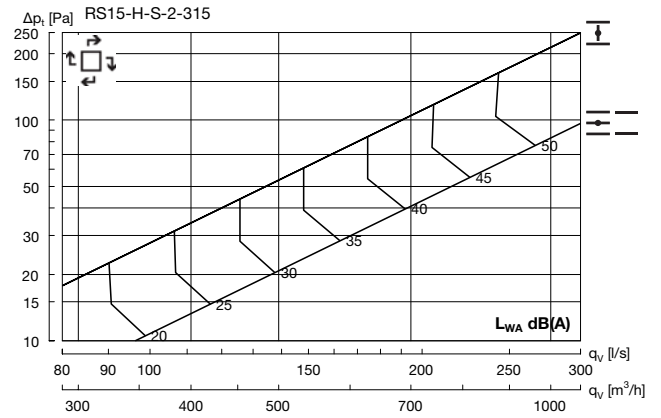

Hz	63	125	250	500	1K	2K	4K	8K
K_{ok}	7	7	2	-1	-7	-16	-25	-35

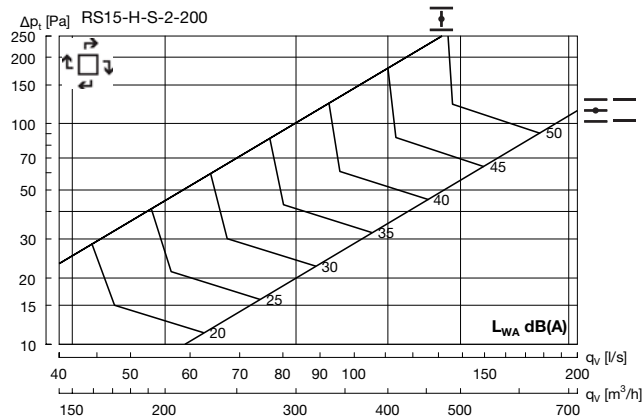

Hz	63	125	250	500	1K	2K	4K	8K
K_{ok}	10	7	2	-2	-6	-14	-21	-29

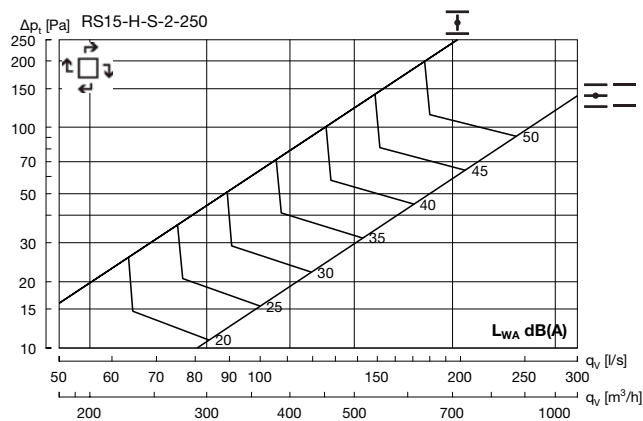

Hz	63	125	250	500	1K	2K	4K	8K
K_{ok}	5	7	3	-1	-7	-16	-23	-31

Versio

RS15

Technical data

RS15 + H - Exhaust air

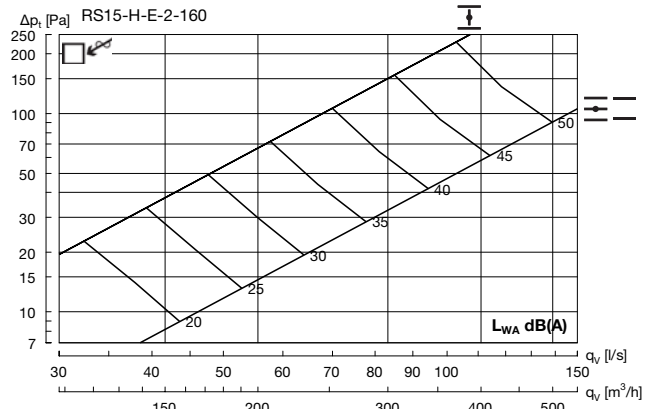

Hz	63	125	250	500	1K	2K	4K	8K
K_{ok}	9	7	6	-4	-10	-13	-22	-31

RS15 + H - Exhaust air

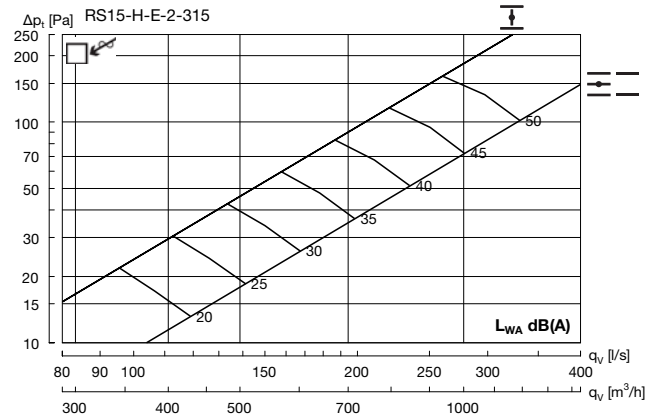

Hz	63	125	250	500	1K	2K	4K	8K
K_{ok}	7	6	2	-2	-5	-12	-24	-33

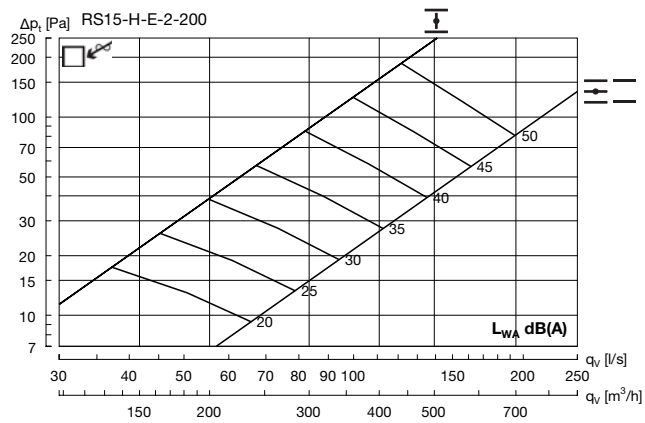

Hz	63	125	250	500	1K	2K	4K	8K
K_{ok}	6	9	4	-4	-8	-12	-19	-29

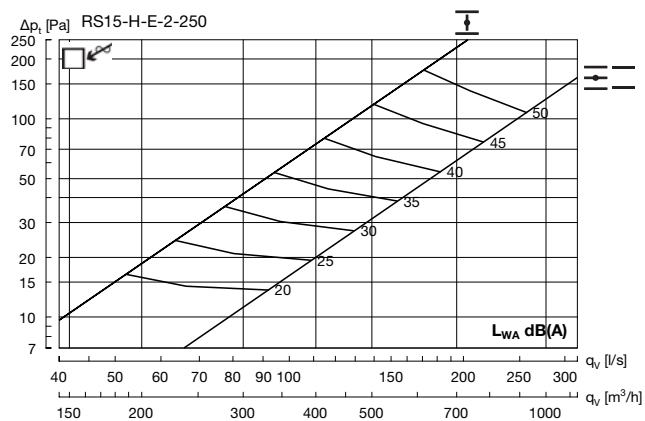

Hz	63	125	250	500	1K	2K	4K	8K
K_{ok}	6	7	2	-2	-6	-13	-22	-31

Versio

RS15

Technical data

RS15 + R - Supply air

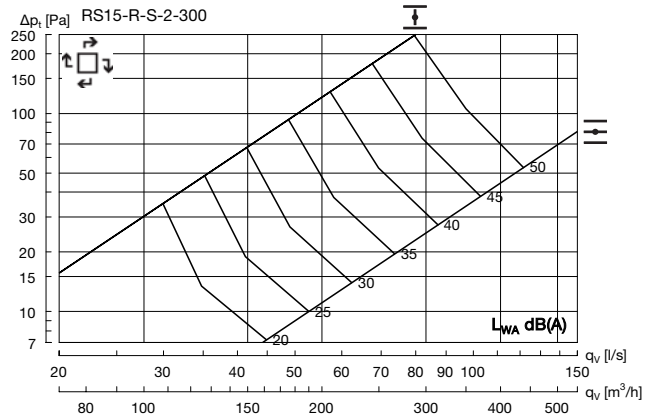

Hz	63	125	250	500	1K	2K	4K	8K
K_{ok}	7	-1	4	-1	-8	-14	-22	-31

RS15 + R - Exhaust air

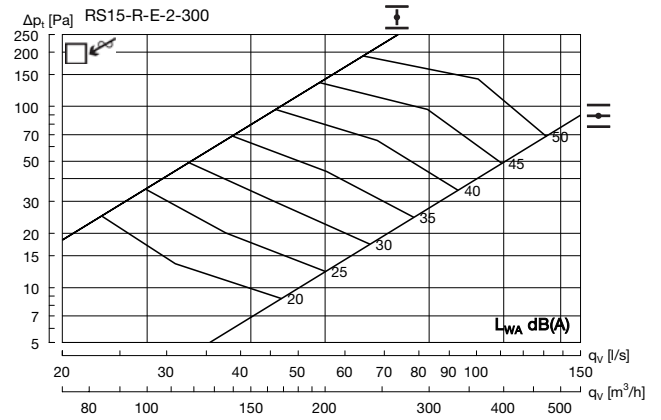

Hz	63	125	250	500	1K	2K	4K	8K
K_{ok}	6	1	4	-2	-7	-10	-17	-25

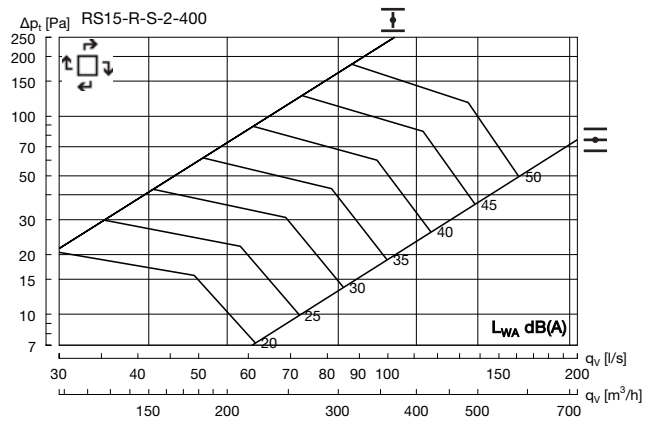

Hz	63	125	250	500	1K	2K	4K	8K
K_{ok}	-2	-1	3	-1	-6	-11	-20	-32

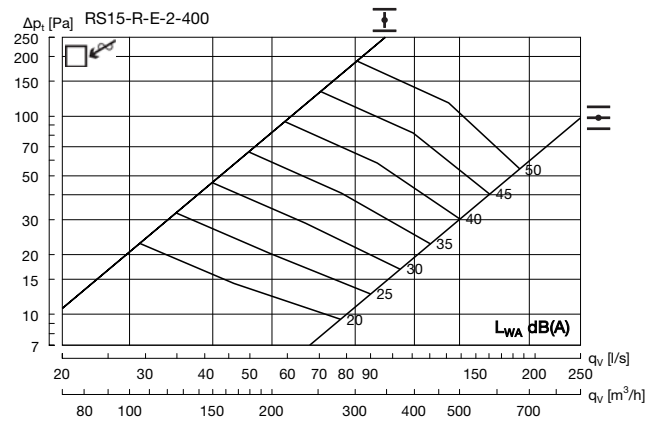

Hz	63	125	250	500	1K	2K	4K	8K
K_{ok}	2	0	2	-2	-5	-10	-16	-24

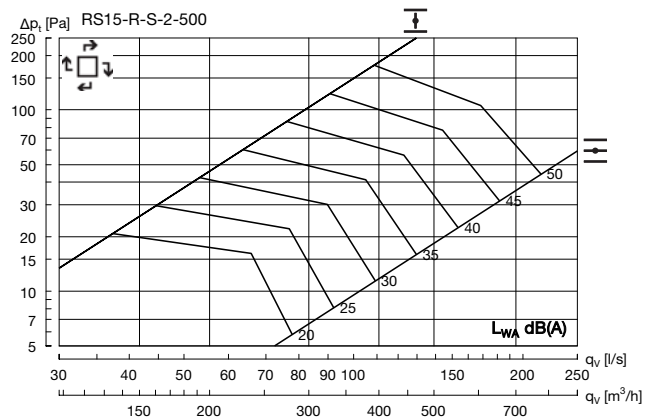

Hz	63	125	250	500	1K	2K	4K	8K
K_{ok}	3	-1	3	-1	-7	-11	-19	-31

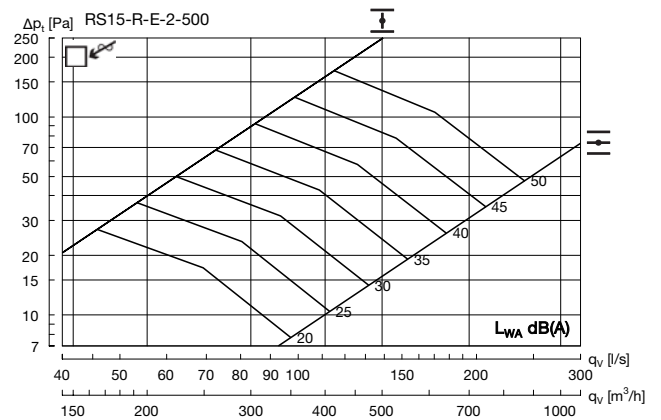

Hz	63	125	250	500	1K	2K	4K	8K
K_{ok}	1	1	1	-2	-6	-9	-16	-25

Versio

RS16



RS16 with upper section type V

Description

RS16 is a square swirl diffuser with adjustable bars that can be used for both supply air and exhaust. The swirl pattern ensures high induction and a large dynamic range, and is therefore ideal for the horizontal supply of very cold air. For exhaust, the diffuser is supplied as standard without bars.

- High capacity
- Large dynamic range
- High induction
- Ideal for the supply of very cold air
- Can be used for both supply air and exhaust

Order code

Product	RS	16	b	c	d	eee	f
Type	RS						
Design		16					
Box type			V - H - R				
Functional use				S = Supply air E = Exhaust			
Damper					0 = No damper (Box : H, V) 1 = Damper (Box : H, R) 2 = Damper / Meas.outlets (Box : H)		
Connection dim.					Ø315 (Box : V) Ø250-315 (Box : H) 500x100 (Box : R)		
Ceiling system							1 - 14 Go to chapter Ceiling tile adaption

Example: RS-16-V-S-0-315-1



RS16 with plenum box type H

Dimensions

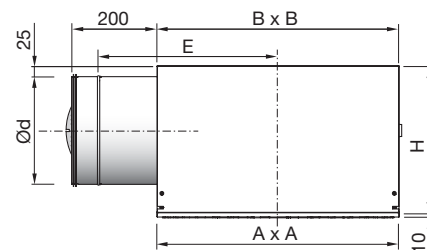

RS16-H	A	B	H	E	Weight
Ød	Pattern	mm	mm	mm	kg
250	600	*-	560	340	12.3
315	600	*-	560	405	13.1

* Face plate dimension A x A depends on ceiling system. See "Ceiling adjustment" for detailed dimensions. For further details on plenum box - see "Plenum boxes".

Maintenance

The face plate can be removed to enable cleaning of internal parts or to gain access to the duct or box. The visible parts of the diffuser can be wiped with a damp cloth.

Materials and finish

Grille box/plenum box:

Material: Galvanised steel

Face plate:

Material: Galvanised steel

Bars: Black ABS-plastic

Standard finish: Powder-coated

Standard colour: RAL 9010, gloss 30

The diffuser is available in other colours. Please contact Lindab's sales department for further information.

Versio

RS16

Accessories

Extension piece

MBZ



Order code

Product **MBZ** **aaa**
 Type _____
 Size _____

Example: MBZ-315

Mounting bracket

PBB



Suspension

MHS



Order code

Product _____ **aaa**
 Type _____

Example: MHS

Plenum box

MBB



RS16-V + MBB

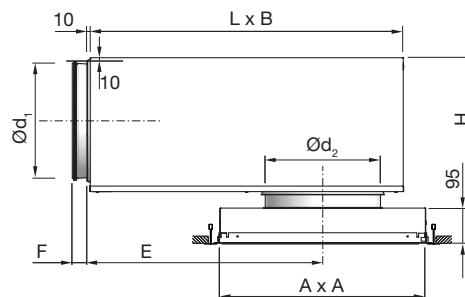

RS16-V + MBB		Pattern	B mm	E mm	F mm	H* mm	L mm
duct Ød ₁ mm	RS16-V Ød ₂ mm						
200	315	600	460	396	70	355 - 395	565
250	315	600	540	486	70	405 - 445	698
315	315	600	540	646	70	470 - 510	858

* Using accessory MBZ the H dimension will increase:
 Ød₂ = 315 mm => H +60 mm

Order code

Product **MBB** **aaa** **315** **c**
 Type _____
 MBB _____
 Duct connection Ød₁ _____
 Ø200-315 _____
 Diffuser dimension Ød₂ _____
 Ø315 _____
 Functional use _____
 S = Supply air
 E = Exhaust

Example: RS-16-V-S-0-315-1+MBB-315-315-S

Versio

RS16

Technical data

Capacity

Air flow q_v [l/s] and [m³/h], total pressure Δp_t [Pa], throw $l_{0,2}$ [m] and sound power level L_{WA} [dB(A)] can be seen in the diagrams.

Frequency-related sound effect level

The sound effect level in the frequency band is defined as $L_{WA}+K_{ok}$. K_{ok} values are specified in charts beneath the diagrams on the following pages.

Quick selection, supply air

RS16-V + MBB

RS16-V + MBB		$\Delta p_t \geq 50$ Pa 30 dB(A)		$\Delta p_t \geq 50$ Pa 35 dB(A)	
duct $\varnothing d_1$	RS16-V $\varnothing d_2$	l/s	m ³ /h	l/s	m ³ /h
200	315	99	356	131	472
250	315	126	454	160	576
315	315	155	558	185	666

RS16 + H

RS16 + H Size $\varnothing d$ mm	Minimum		$\Delta p_t \geq 50$ Pa 30 dB(A)		$\Delta p_t \geq 50$ Pa 35 dB(A)	
	l/s	m ³ /h	l/s	m ³ /h	l/s	m ³ /h
250	71	254	-	-	112	403
315	95	342	-	-	174	626

Sound attenuation

Sound attenuation of the diffusers ΔL from duct to room, including end reflection - see table below.

RS16-V + MBB

RS16-V + MBB		Centre frequency Hz							
duct $\varnothing d_1$	RS16-V $\varnothing d_2$	63	125	250	500	1K	2K	4K	8K
200	315	13	9	3	16	16	15	17	16
250	315	12	7	5	17	16	17	17	18
315	315	8	10	8	17	18	17	18	23

RS16 + H

RS16 + H		Centre frequency Hz							
Size $\varnothing d$ mm		63	125	250	500	1K	2K	4K	8K
250		13	8	4	8	5	5	7	9
315		12	7	5	11	5	5	6	8

RS16 + R

RS16 + R		Mean frequency Hz							
Size-2 mm		63	125	250	500	1K	2K	4K	8K
500x100		12	7	2	4	2	5	5	5

Versio

RS16

Technical data

Throw $l_{0,2}$

Throw $l_{0,2}$ [m] is specified at a terminal velocity of 0.2 m/s. The designation by the lines specifies the pattern of dispersal.

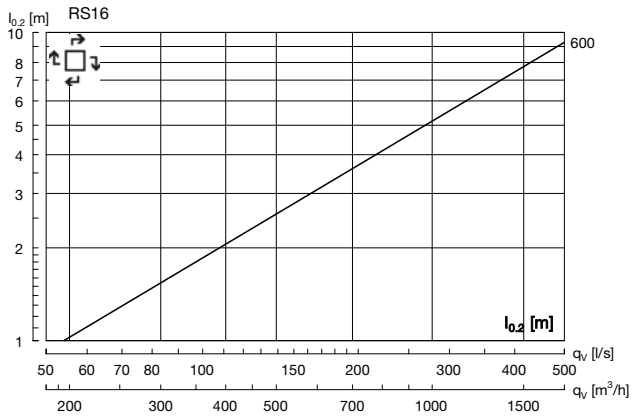

RS16-V without plenum box – Supply air

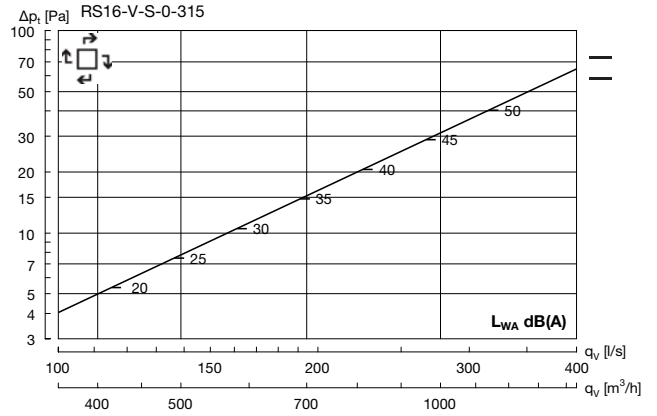

Versio

RS16

Technical data

RS16-V 315 + MBB - Supply air

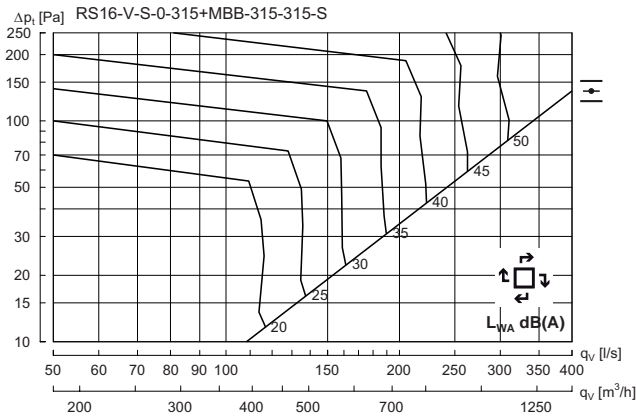

Hz	63	125	250	500	1K	2K	4K	8K
K_{sk}	8	1	-1	0	-6	-14	-21	-30

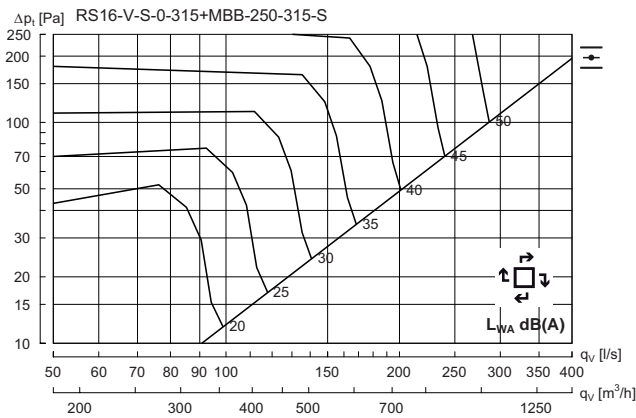

Hz	63	125	250	500	1K	2K	4K	8K
K_{sk}	10	4	-1	-1	-5	-12	-19	-26

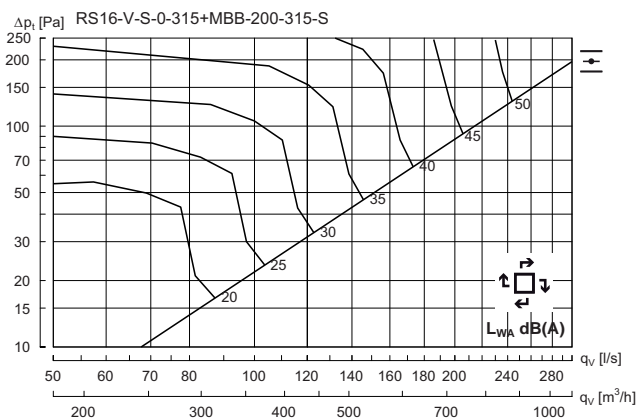

Hz	63	125	250	500	1K	2K	4K	8K
K_{sk}	12	7	-1	-2	-5	-12	-18	-24

- 1
- 2
- 3
- 4
- 5
- 6
- 7
- 8
- 9
- 10
- 11
- 12
- 13
- 14
- 15
- 16
- 17
- 18

Versio

RS16

Technical data

RS16-V without plenum box – Exhaust air

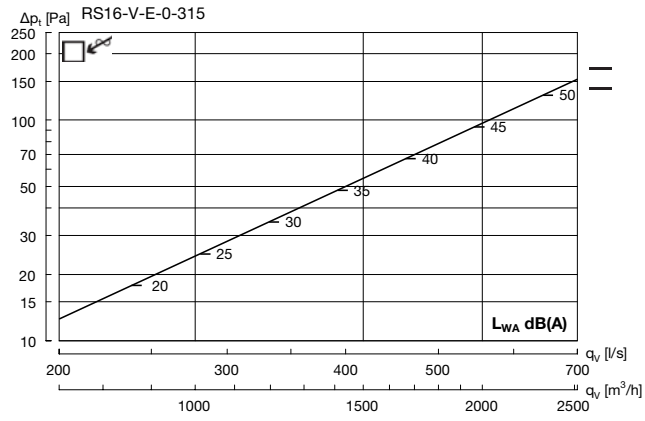

RS16-V 315 + MBB - Exhaust air

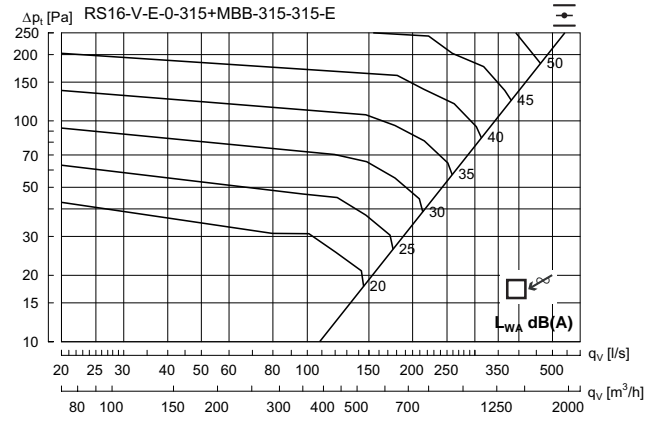

Hz	63	125	250	500	1K	2K	4K	8K
K_{ok}	11	5	3	-4	-6	-9	-15	-26

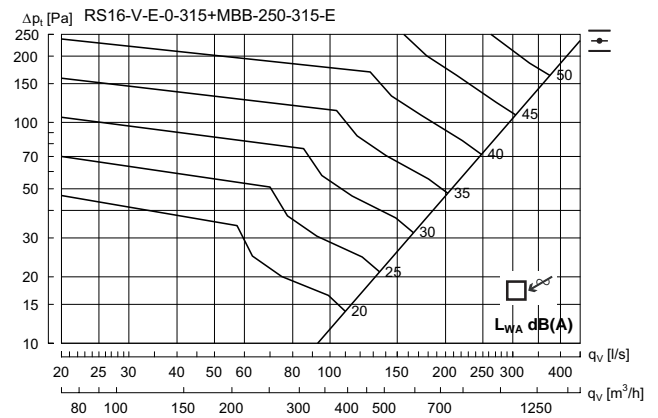

Hz	63	125	250	500	1K	2K	4K	8K
K_{ok}	11	6	3	-4	-6	-11	-16	-24

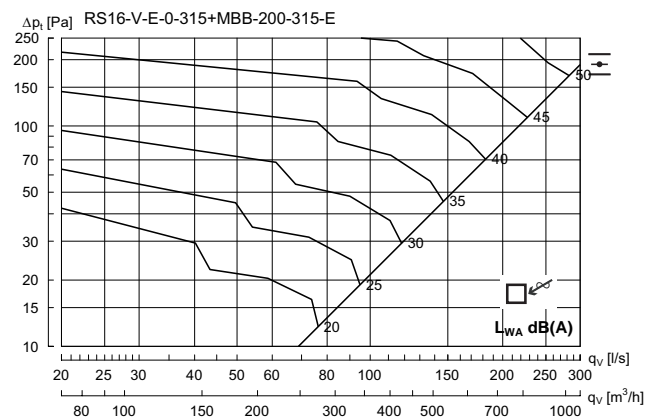

Hz	63	125	250	500	1K	2K	4K	8K
K_{ok}	14	5	1	-3	-6	-9	-13	-21

Versio

RS16

Technical data

RS16 + H - Supply air

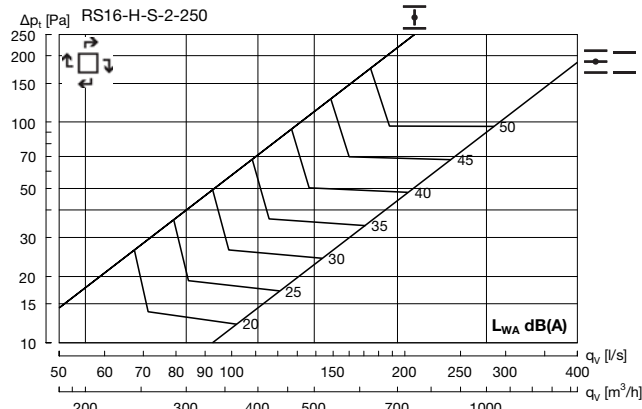

Hz	63	125	250	500	1K	2K	4K	8K
K_{ok}	5	5	2	-1	-6	-13	-19	-27

RS16 + H - Exhaust air

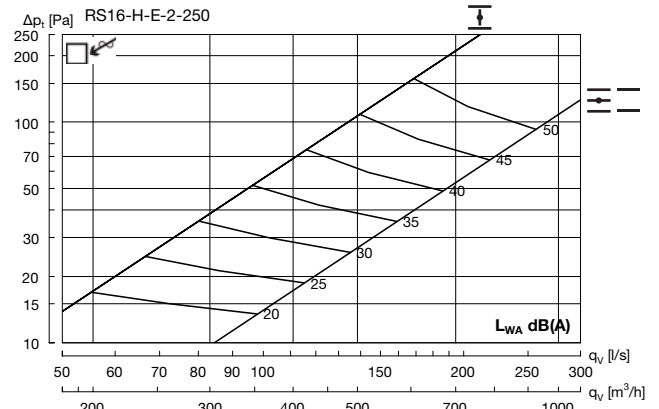

Hz	63	125	250	500	1K	2K	4K	8K
K_{ok}	2	6	3	-2	-7	-12	-21	-30

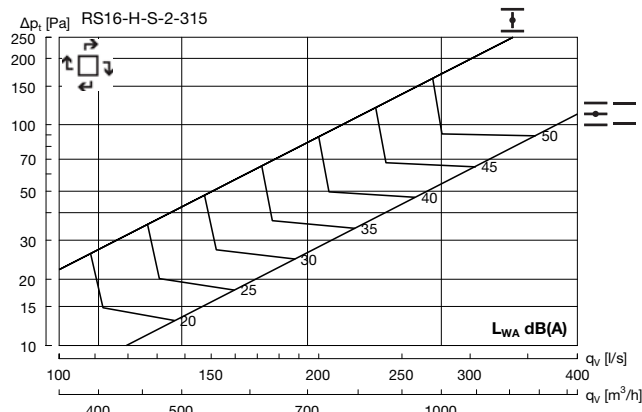

Hz	63	125	250	500	1K	2K	4K	8K
K_{ok}	8	5	1	-1	-5	-13	-21	-31

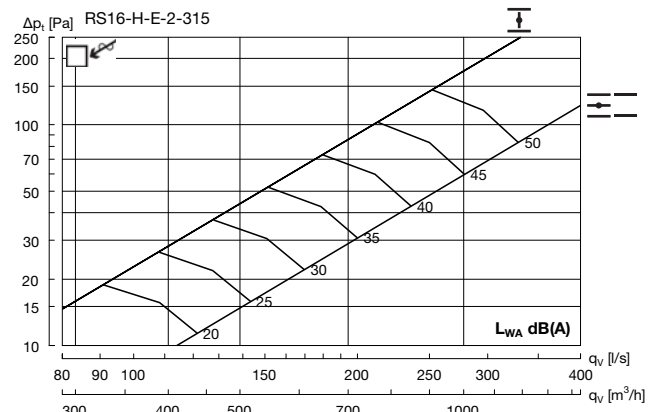

Hz	63	125	250	500	1K	2K	4K	8K
K_{ok}	8	5	2	-2	-5	-12	-21	-32

- 1
- 2
- 3
- 4
- 5
- 6
- 7
- 8
- 9
- 10
- 11
- 12
- 13
- 14
- 15
- 16
- 17
- 18

Versio

RS16

Technical data

RS16 + R - Supply air

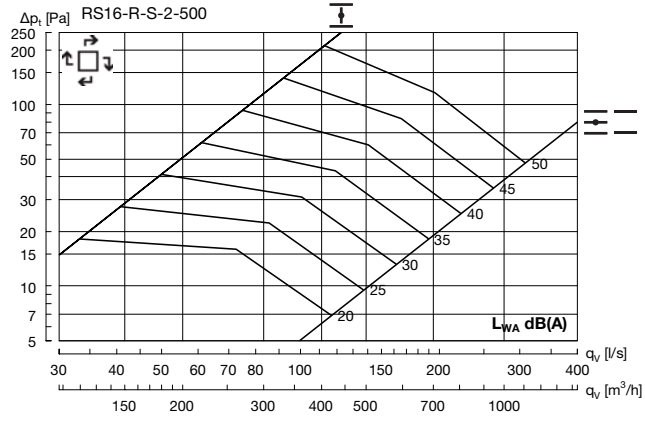

Hz	63	125	250	500	1K	2K	4K	8K
K_{ok}	9	2	3	-1	-8	-12	-21	-28

RS16 + R - Exhaust air

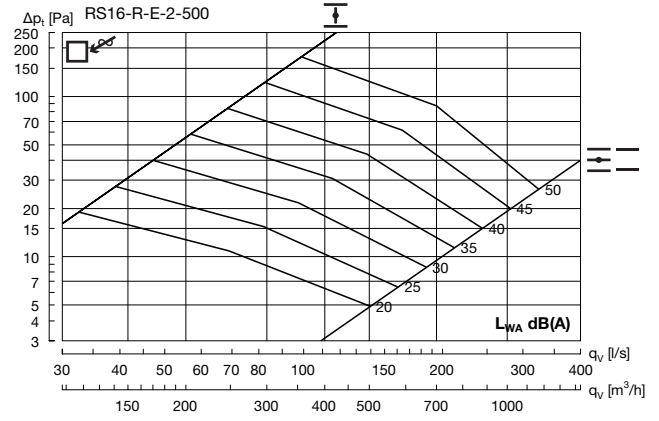

Hz	63	125	250	500	1K	2K	4K	8K
K_{ok}	8	0	0	-3	-5	-8	-18	-26

Versio

NS19



NS19 with grille box type V

Description

NS19 is a square diffuser with individually adjustable nozzles. The diffuser is suitable for the horizontal supply of cooled air, where great flexibility in the dispersal pattern is required. The diffuser can also be set to a vertical supply air pattern, enabling supply of heated air. The diffuser is supplied as standard with nozzles set for swirl.

- Adjustable dispersal patterns
- No pressure change for different dispersal patterns
- Suitable for horizontal or vertical supply air

Maintenance

The face plate can be removed to enable cleaning of internal parts or to gain access to the duct or box. The visible parts of the diffuser can be wiped with a damp cloth.

Order code

Product	NS	19	b	S	d	eee	f
Type	NS						
Design		19					
Box type			V - H - R				
Functional use				S = Supply air			
Damper							
0 = No damper	(Box	:	H, V)				
1 = Damper	(Box	:	H, R)				
2 = Damper / Meas.outlets	(Box	:	H)				
Connection dim.							
Ø160-315	(Box	:	V)				
Ø125-315	(Box	:	H)				
200x100 - 500x100	(Box	:	R)				
Ceiling system							
1 - 14							Go to chapter Ceiling tile adaption

Example: NS-19-V-S-0-200-1



NS19 with plenum box type H

Dimensions

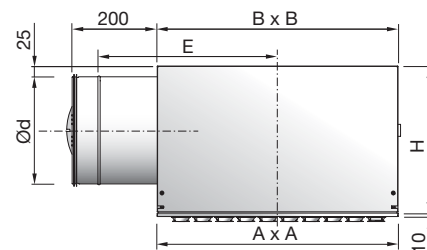

NS19-H	Ød	Pattern	A mm	B mm	H mm	E mm	Weight kg
	125	300	*-	380	215	350	3.30
	160	400	*-	380	250	350	4.60
	200	500	*-	460	290	390	6.50
	250	600	*-	560	340	420	9.30
	315	600	*-	560	405	420	10.1

* Face plate dimension A x A depends on ceiling system. See "Ceiling systems" for detailed dimensions. For further details on plenum box, see "Plenum boxes".

Materials and finish

Grille box/plenum box:

Material: Galvanised steel

Face plate:

Material: Galvanised steel

Nozzles: White, ABS.plastic

Standard finish: Powder-coated

Standard colour: RAL 9003, gloss 30

The diffuser is available in other colours. Please contact Lindab's sales department for further information.

Versio

NS19

Accessories

Extension piece

MBZ

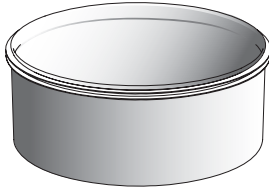

Order code

Product **MBZ** **aaa**
 Type _____
 Size _____

Example: MBZ-200

Mounting bracket

PBB



Suspension

MHS



Order code

Product _____ **aaa**
 Type _____

Example: MHS

Plenum box

MBB



NS19-V + MBB

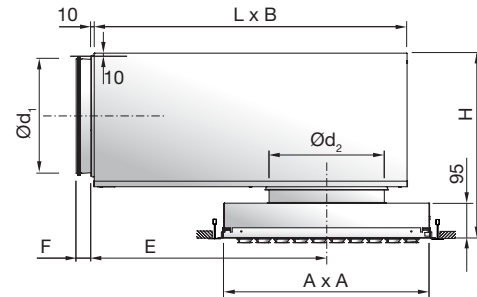

NS19-V + MBB		Pattern	B mm	E mm	F mm	H* mm	L mm
duct Ød ₁ mm	NS19-V Ød ₂ mm						
100	160	300	260	216	50	255 - 295	310
125	160	300	310	262	50	280 - 320	376
125	200	400	310	262	50	280 - 320	376
160	160	300	380	323	50	314 - 354	459
160	200	400	380	323	50	314 - 354	459
160	250	500	380	323	50	314 - 354	459
200	200	400	460	396	70	355 - 395	565
200	250	500	460	396	70	355 - 395	565
200	315	600	460	396	70	355 - 395	565
250	250	500	540	486	70	405 - 445	698
250	315	600	540	486	70	405 - 445	698
315	315	600	540	646	70	470 - 510	858

* Using accessory MBZ the H dimension will increase:

Ød₂ = 160 - 200 mm => H +40 mm

Ød₂ = 250 - 315 mm => H +60 mm

Order code

Product **MBB** **aaa** **bbb** **S**
 Type _____
 MBB _____
 Duct connection Ød₁ _____
 Ø100-315 _____
 Diffuser dimension Ød₂ _____
 Ø160-315 _____
 Functional use _____
 S = Supply air

Example: NS-19-V-S-0-200-1+MBB-200-200-S

Versio

NS19

Technical data

Capacity

Air flow q_v [l/s] and [m³/h], total pressure Δp_t [Pa], throw $l_{0,2}$ [m] and sound power level L_{WA} [dB(A)] can be seen in the diagrams.

Frequency-related sound effect level

The sound effect level in the frequency band is defined as $L_{WA}+K_{ok}$. K_{ok} values are specified in charts beneath the diagrams on the following pages.

Quick selection, supply air

NS19-V + MBB

NS19-V + MBB		$\Delta p_t \geq 50$ Pa		$\Delta p_t \geq 50$ Pa	
duct	NS19-V	30 dB(A)		35 dB(A)	
$\text{Ø}d_1$	$\text{Ø}d_2$	l/s	m ³ /h	l/s	m ³ /h
100	160	37	133	44	158
125	160	45	162	56	202
125	200	52	187	63	227
160	160	48	173	58	209
160	200	60	216	74	266
160	250	70	252	88	317
200	200	68	245	82	295
200	250	80	288	97	349
200	315	89	320	114	410
250	250	89	320	105	378
250	315	104	374	128	461
315	315	129	464	152	547

Supply air

NS19 + H

NS19 + H		$\Delta p_t \geq 50$ Pa		$\Delta p_t \geq 50$ Pa		
Size $\text{Ø}d$	Minimum	30 dB(A)		35 dB(A)		
mm	l/s	m ³ /h	l/s	m ³ /h	l/s	m ³ /h
125	26	93	31	112	40	144
160	33	118	50	180	60	216
200	57	204	60	216	77	277
250	71	254	95	342	113	407
315	95	342	-	-	147	529

Sound attenuation

Sound attenuation of the diffusers ΔL from duct to room, including end reflection - see table below.



NS19-V + MBB

NS19-V + MBB		Centre frequency Hz							
duct	NS19-V	63	125	250	500	1K	2K	4K	8K
$\text{Ø}d_1$	$\text{Ø}d_2$								
100	160	18	16	5	17	20	19	18	21
125	160	17	13	8	20	18	18	18	21
125	200	13	11	5	16	17	16	17	19
160	160	17	16	11	23	21	20	21	21
160	200	13	14	8	22	21	19	20	21
160	250	14	14	5	19	17	17	18	20
200	200	13	10	7	17	20	17	19	18
200	250	12	9	6	16	18	17	19	17
200	315	12	8	3	14	17	15	17	17
250	250	14	9	7	18	19	19	19	19
250	315	14	7	5	16	17	18	18	18
315	315	8	9	8	16	18	17	18	24

NS19 + H

NS19 + H		Centre frequency Hz							
Size $\text{Ø}d$		63	125	250	500	1K	2K	4K	8K
mm									
125		17	15	5	12	12	7	8	12
160		17	13	4	13	14	7	7	10
200		15	9	3	14	10	8	8	14
250		12	8	5	10	7	7	8	13
315		12	6	5	12	6	6	8	13

Installation -and balancing instruction

For further information go to www.lindQST.com and installation -and balancing instruction.

Versio

NS19

Technical data

Throw $l_{0,2}$

Throw $l_{0,2}$ [m] is specified at a terminal velocity of 0.2 m/s. The designation by the lines specifies the pattern of dispersal.

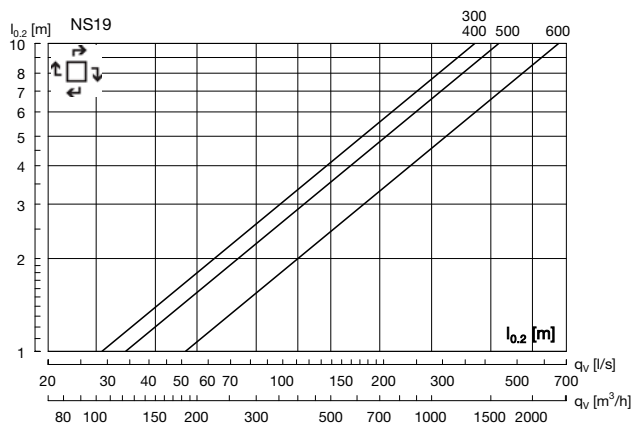

Correction throw

4-way	3-way	2-way	1-way
1,3	2	2,5	4,6

Air patterns



4 - ways

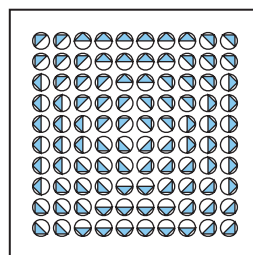

3 - ways

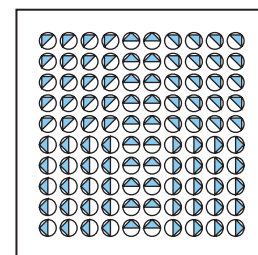

2 - ways

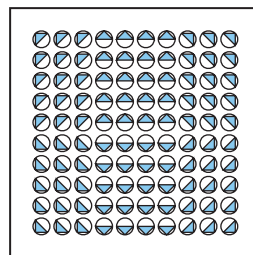

1 - ways

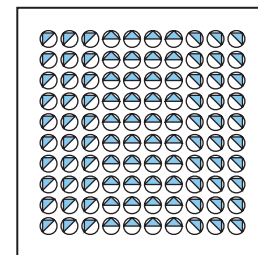

Rotation

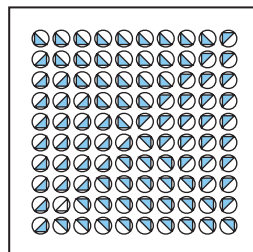

2 - ways corner

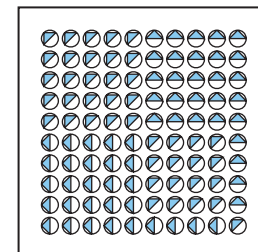

Versio

NS19

Technical data

Throws/turning points

Throw $l_{0,2}$ [m] can be seen in the diagram. The throw applies for isothermal air at a terminal velocity of 0.2 m/s. Turning point $l_{0,0}$ (m) can be seen in the diagram for heated air, +5 K and +10 K respectively. The designation by the lines specifies the pattern of dispersal.

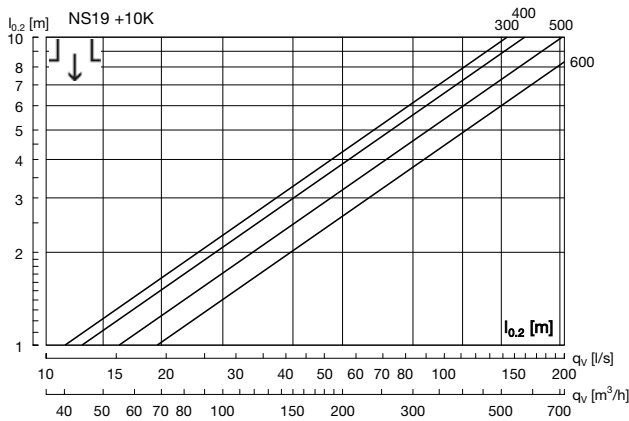
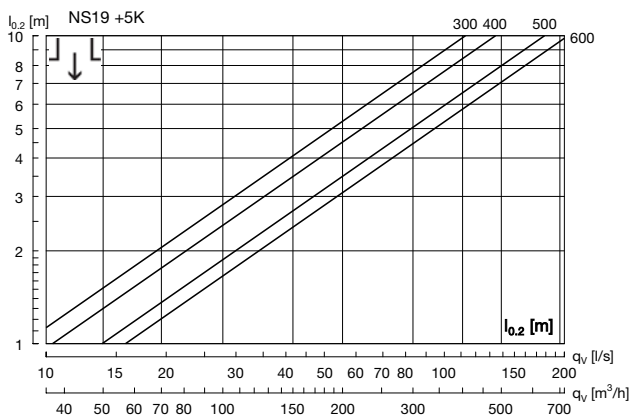
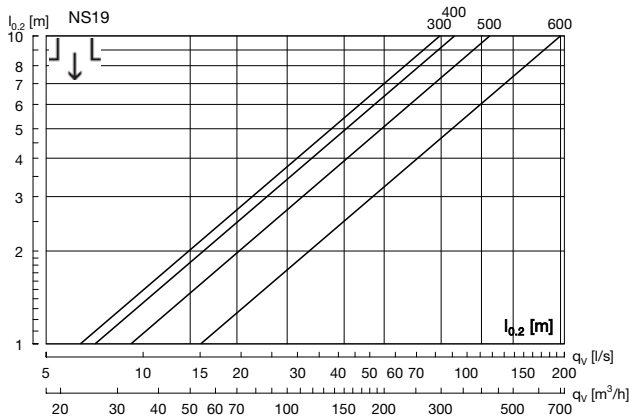

Nozzle setting - vertical

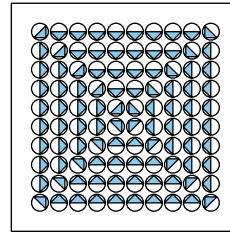

NS19-V without plenum box

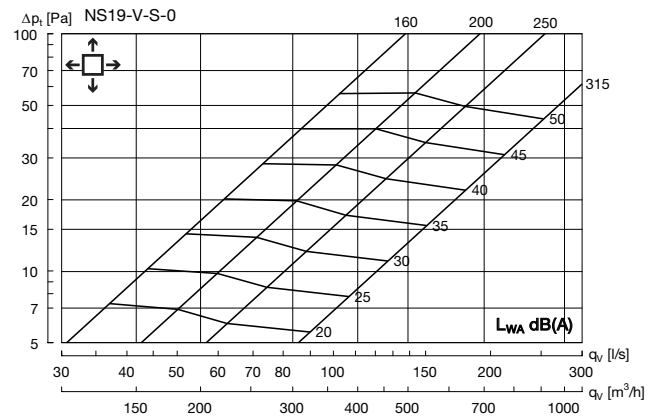

- 1
- 2
- 3
- 4
- 5
- 6
- 7
- 8
- 9
- 10
- 11
- 12
- 13
- 14
- 15
- 16
- 17
- 18

Versio

NS19

Technical data

NS19-V 160 + MBB - Supply air

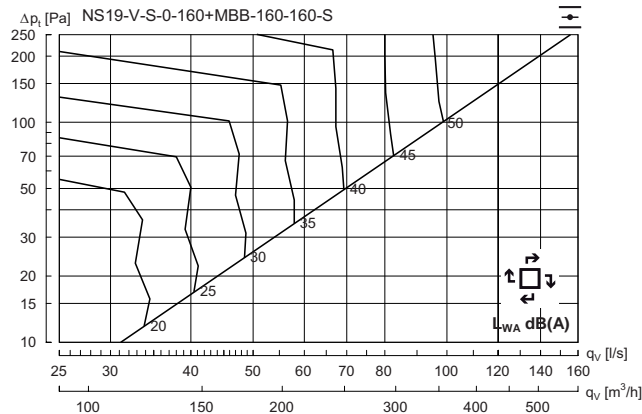

Hz	63	125	250	500	1K	2K	4K	8K
K_{ok}	10	4	-2	1	-6	-15	-22	-33

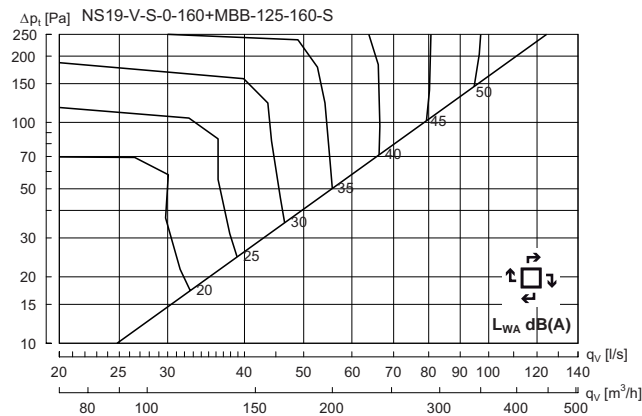

Hz	63	125	250	500	1K	2K	4K	8K
K_{ok}	8	5	-1	0	-6	-13	-18	-28

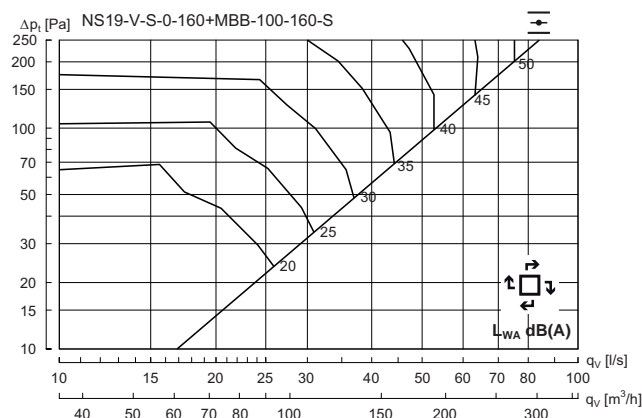

Hz	63	125	250	500	1K	2K	4K	8K
K_{ok}	11	4	2	-1	-8	-12	-16	-22

NS19-V 200 + MBB - Supply air

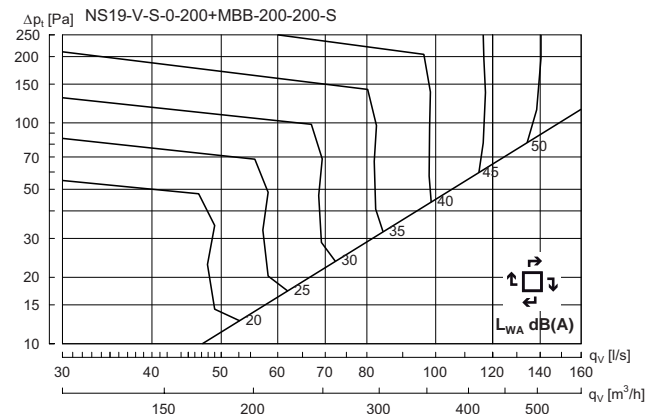

Hz	63	125	250	500	1K	2K	4K	8K
K_{ok}	11	4	-3	0	-5	-16	-23	-33

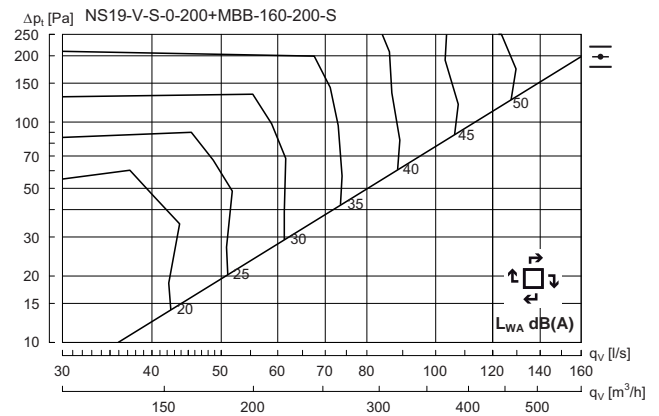

Hz	63	125	250	500	1K	2K	4K	8K
K_{ok}	12	5	-1	-1	-5	-13	-19	-26

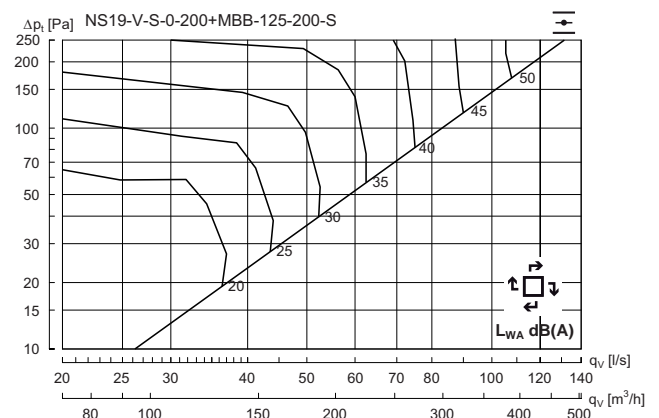

Hz	63	125	250	500	1K	2K	4K	8K
K_{ok}	8	6	2	-1	-7	-13	-18	-26

Versio

NS19

Technical data

NS19-V 250 + MBB - Supply air

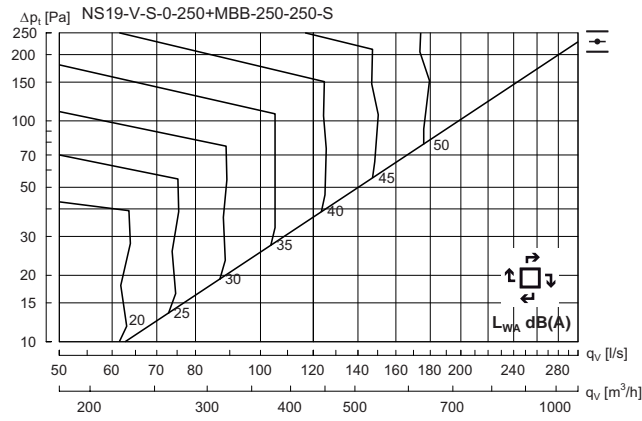

Hz	63	125	250	500	1K	2K	4K	8K
K_{ok}	8	4	-4	0	-5	-16	-24	-37

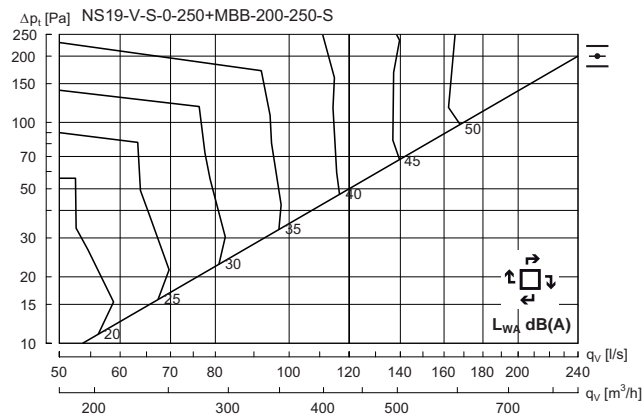

Hz	63	125	250	500	1K	2K	4K	8K
K_{ok}	9	6	-2	0	-5	-15	-22	-33

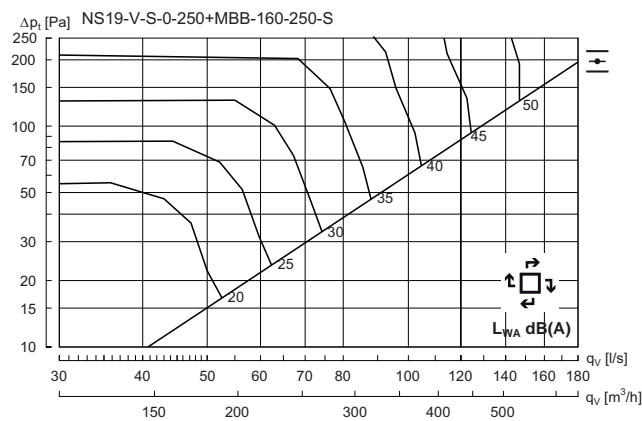

Hz	63	125	250	500	1K	2K	4K	8K
K_{ok}	13	6	0	-1	-5	-12	-18	-26

NS19-V 315 + MBB - Supply air

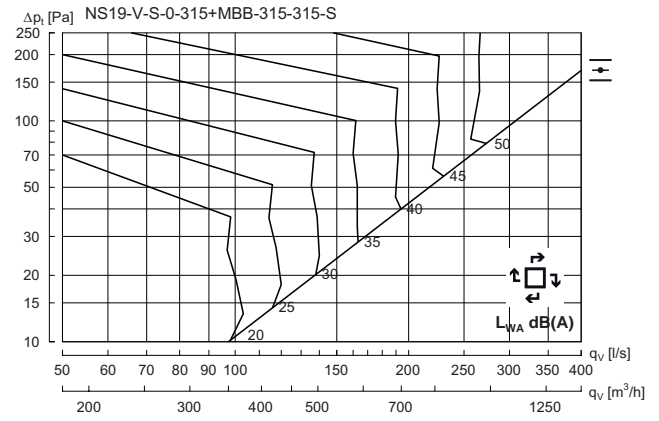

Hz	63	125	250	500	1K	2K	4K	8K
K_{ok}	10	1	-2	0	-5	-16	-23	-34

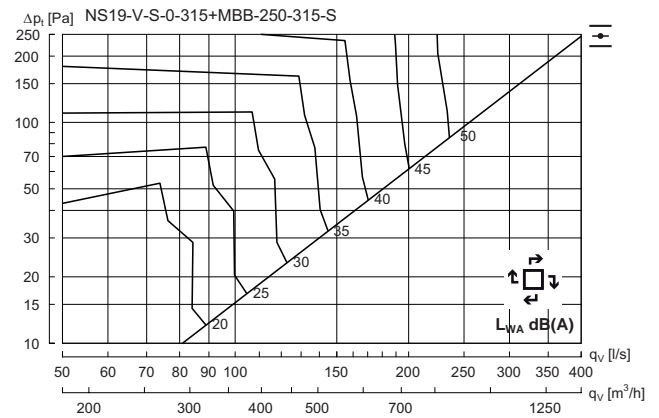

Hz	63	125	250	500	1K	2K	4K	8K
K_{ok}	10	3	-2	0	-5	-15	-21	-28

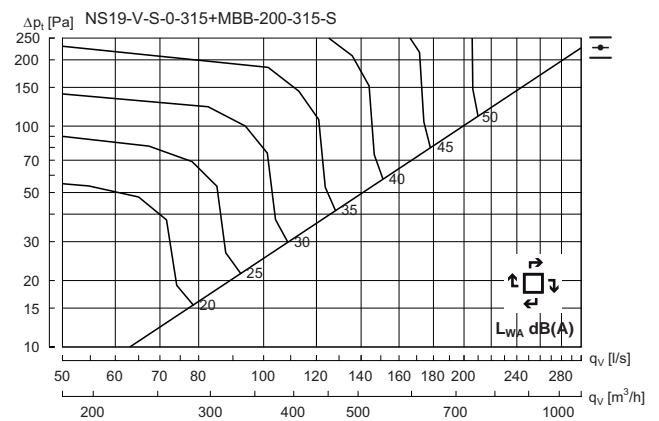

Hz	63	125	250	500	1K	2K	4K	8K
K_{ok}	9	6	-1	-1	-5	-13	-20	-28

Versio

NS19

Technical data

NS19 + H - Supply air

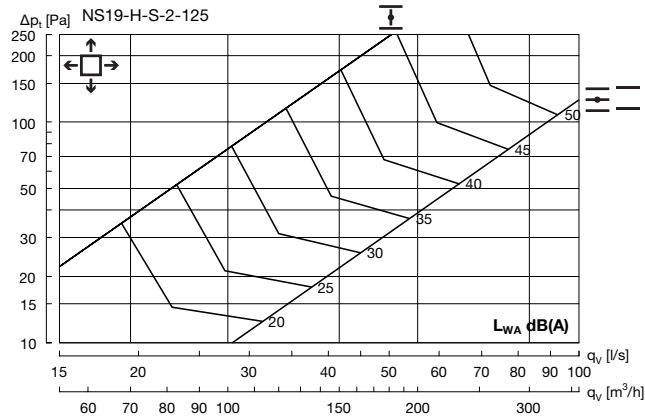

Hz	63	125	250	500	1K	2K	4K	8K
K_{ok}	9	7	6	-4	-9	-15	-21	-28

NS19 + H - Supply air

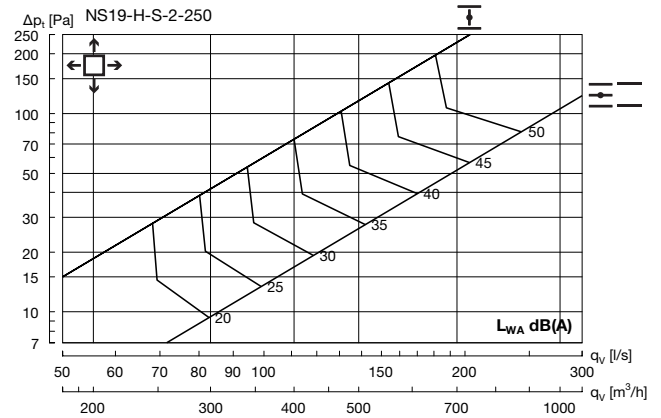

Hz	63	125	250	500	1K	2K	4K	8K
K_{ok}	6	7	3	-1	-7	-16	-22	-31

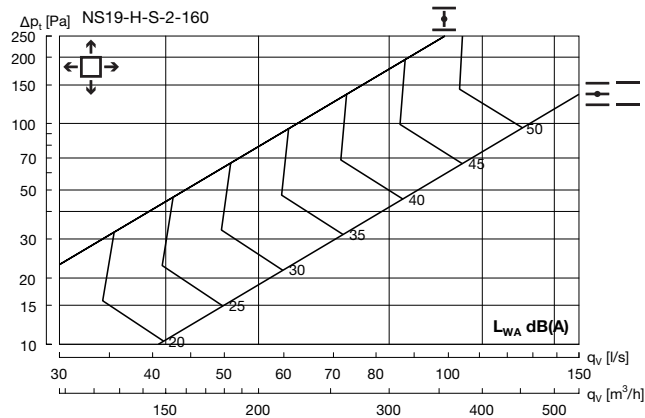

Hz	63	125	250	500	1K	2K	4K	8K
K_{ok}	9	7	6	-4	-9	-15	-21	-28

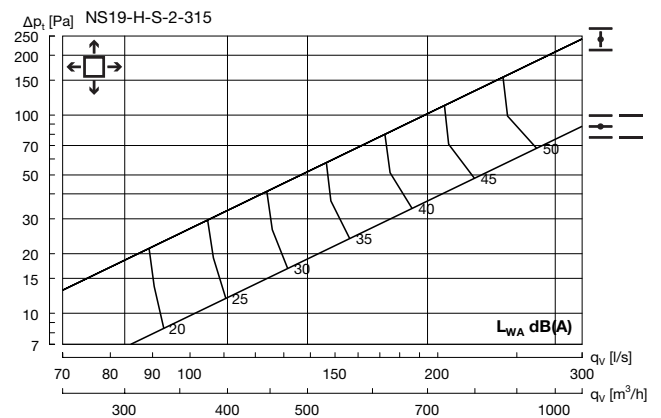

Hz	63	125	250	500	1K	2K	4K	8K
K_{ok}	6	7	3	-1	-8	-17	-25	-36

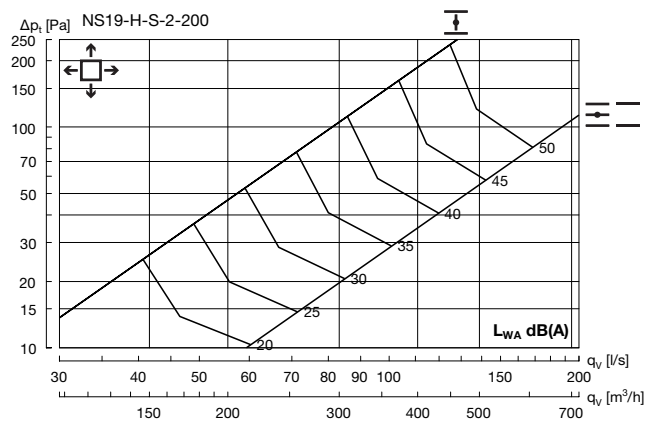

Hz	63	125	250	500	1K	2K	4K	8K
K_{ok}	11	6	3	-1	-7	-16	-22	-30

Versio

GS23



GS23 with grille box type V

Description

GS23 is a square diffuser with an aluminium grid. GS23 is used for exhaust.

- High capacity

Maintenance

The face plate can be removed to enable cleaning of internal parts or to gain access to the duct or box. The visible parts of the diffuser can be wiped with a damp cloth.

Order code

Product	GS	23	b	E	d	eee	f
Type	GS						
Design		23					
Box type			V - H - R				
Functional use				E = Exhaust			
Damper							
0 = No damper	(Box						: H, V)
1 = Damper	(Box						: H, R)
2 = Damper / Meas.outlets	(Box						: H)
Connection dim.							
Ø160-315	(Box						: V)
Ø125-315	(Box						: H)
200x100 - 500x100	(Box						: R)
Ceiling system							
1 - 14							Go to chapter Ceiling tile adaption

Example: GS-23-V-E-0-200-1



GS23 with plenum box type H

Dimensions

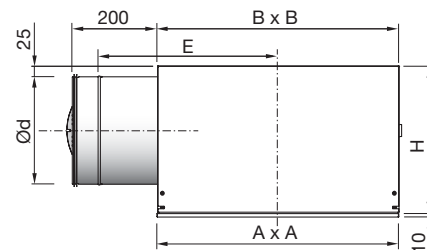

GS23-H	Ød	Pattern	A mm	B mm	H mm	E mm	Weight kg
	125	300	*-	380	215	350	5.9
	160	400	*-	380	250	350	5.9
	200	500	*-	460	290	390	8.5
	250	600	*-	560	340	420	12.3
	315	600	*-	560	405	420	13.1

* Face plate dimension A x A depends on ceiling system. See "Ceiling adjustment" for detailed dimensions. For further details on plenum box, see "Plenum boxes".

Materials and finish

Grille box/plenum box:

Material: Galvanised steel

Face plate:

Material: Galvanised steel

Grid: Aluminium

Standard finish: Powder-coated

Standard colour: RAL 9010, gloss 30

The diffuser is available in other colours. Please contact Lindab's sales department for further information.

Versio

GS23

Accessories

Extension piece

MBZ

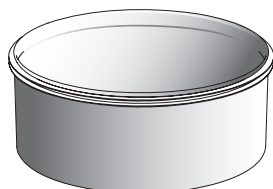

Order code

Product **MBZ** **aaa**
 Type _____
 Size _____

Example: MBZ-200

Mounting bracket

PBB



Suspension

MHS



Order code

Product _____ **aaa**
 Type _____

Example: MHS

Plenum box

MBB



GS23-V + MBB

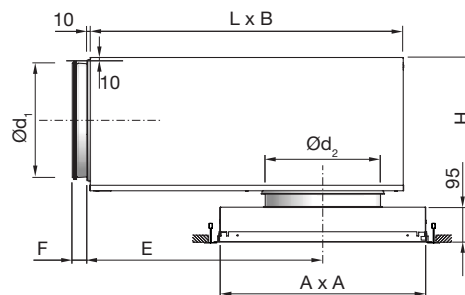

GS23-V + MBB							
duct	GS23-V		B	E	F	H*	L
Ød ₁ mm	Ød ₂ mm	Pattern	mm	mm	mm	mm	mm
100	160	300	260	216	50	255 - 295	310
125	160	300	310	262	50	280 - 320	376
125	200	400	310	262	50	280 - 320	366
160	160	300	380	323	50	314 - 354	459
160	200	400	380	323	50	314 - 354	459
160	250	500	380	323	50	314 - 354	459
200	200	400	460	396	70	355 - 395	565
200	250	500	460	396	70	355 - 395	565
200	315	600	460	396	70	355 - 395	565
250	250	500	540	486	70	405 - 445	698
250	315	600	540	486	70	405 - 445	698
315	315	600	540	646	70	470 - 510	858

* Using accessory MBZ the H dimension will increase:
 Ød₂ = 160 - 200 mm => H +40 mm
 Ød₂ = 250 - 315 mm => H +60 mm

Order code

Product _____ **MBB** **aaa** **bbb** **E**
 Type _____
 MBB _____
 Duct connection Ød₁ _____
 Ø100-315 _____
 Diffuser dimension Ød₂ _____
 Ø160-315 _____
 Functional use _____
 E = Exhaust _____

Example: GS-23-V-E-0-200-1+MBB-200-200-E

Versio

GS23

Technical data

Capacity

Air flow q_v [l/s] and [m³/h], total pressure Δp_t [Pa], throw $l_{0,2}$ [m] and sound power level L_{WA} [dB(A)] can be seen in the diagrams.

Sound attenuation

Sound attenuation of the diffusers ΔL from duct to room, including end reflection - see table below.

GS23 + H

GS23 + H Size Ød mm	Centre frequency Hz							
	63	125	250	500	1K	2K	4K	8K
125	17	16	5	9	10	4	5	5
160	16	14	3	11	11	4	4	4
200	15	9	2	11	7	4	4	6
250	14	8	3	9	4	3	4	6
315	12	6	4	10	3	3	4	6

GS23-V + MBB

duct Ød ₁	GS23-V Ød ₂	Centre frequency Hz							
		63	125	250	500	1K	2K	4K	8K
100	160	20	16	5	19	20	19	18	21
125	160	16	13	9	20	18	18	19	20
125	200	14	12	6	17	16	16	18	19
160	160	17	16	10	24	20	20	21	21
160	200	15	15	7	22	21	19	20	21
160	250	15	14	5	20	16	16	17	19
200	200	14	11	7	18	21	17	20	18
200	250	13	9	5	17	18	16	18	17
200	315	13	8	3	15	17	15	17	16
250	250	15	8	7	18	18	18	18	19
250	315	15	7	6	16	16	17	17	18
315	315	8	11	8	16	18	17	17	22

Installation -and balancing instruction

For further information go to www.lindQST.com and installation -and balancing instruction.

GS23-V without plenum box - Exhaust air

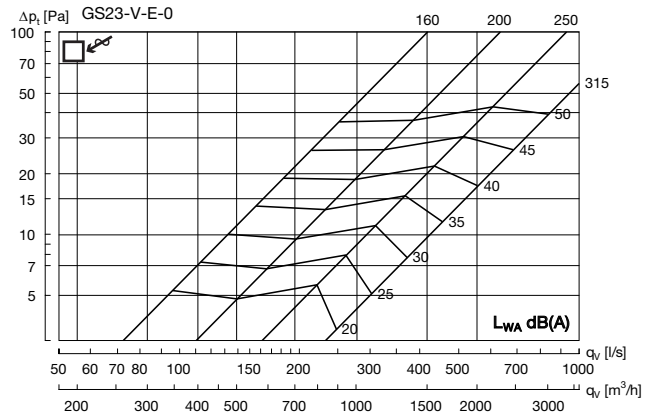

- 1
- 2
- 3
- 4
- 5
- 6
- 7
- 8
- 9
- 10
- 11
- 12
- 13
- 14
- 15
- 16
- 17
- 18

Versio

GS23

Technical data

GS23-V 160 + MBB - Exhaust air

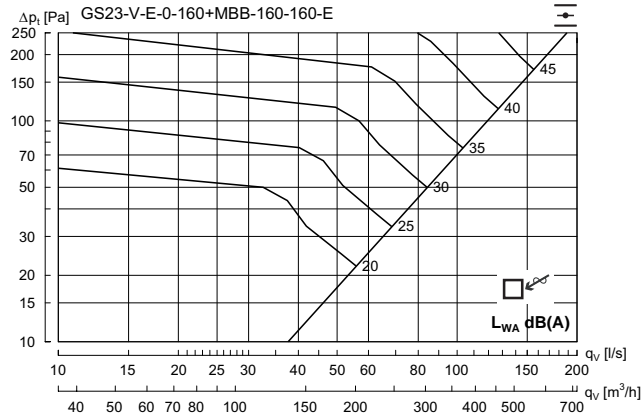

Hz	63	125	250	500	1K	2K	4K	8K
K_{ok}	15	5	0	-3	-6	-9	-14	-19

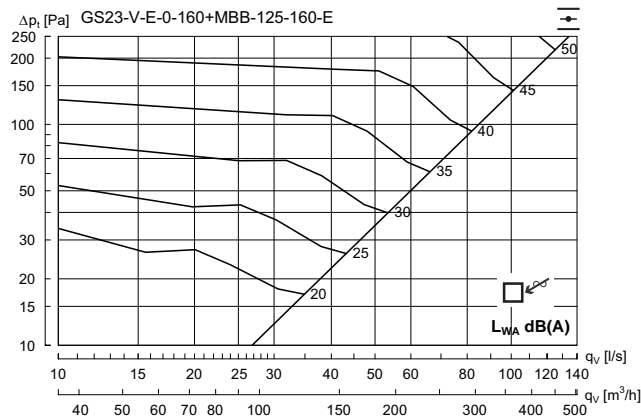

Hz	63	125	250	500	1K	2K	4K	8K
K_{ok}	11	5	1	-2	-6	-11	-15	-22

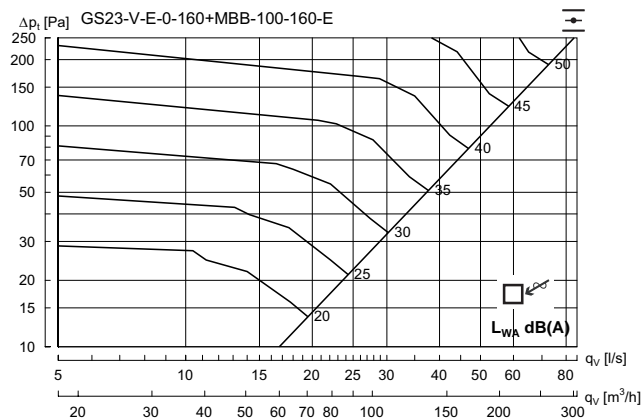

Hz	63	125	250	500	1K	2K	4K	8K
K_{ok}	8	4	4	-2	-8	-12	-16	-23

GS23-V 200 + MBB - Exhaust air

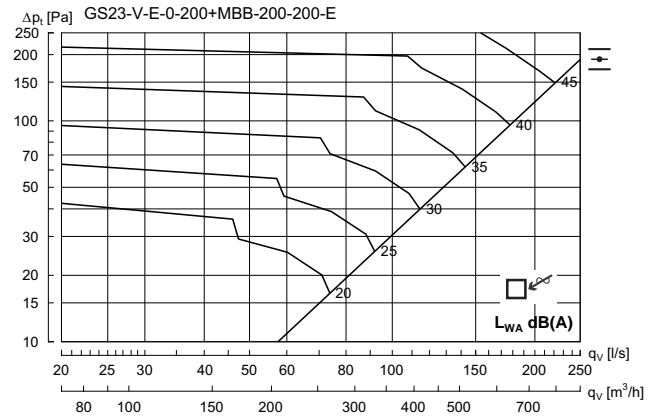

Hz	63	125	250	500	1K	2K	4K	8K
K_{ok}	14	5	1	-3	-6	-9	-13	-21

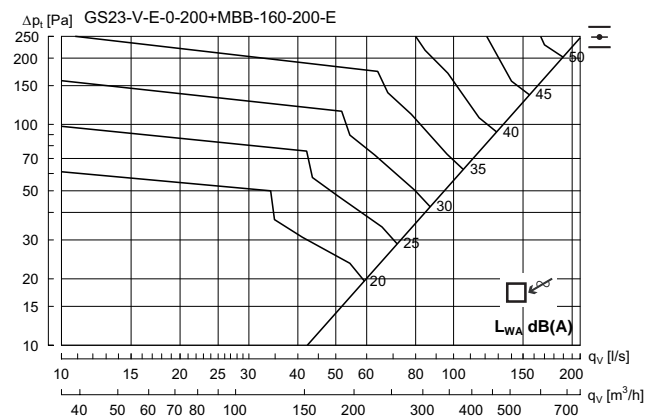

Hz	63	125	250	500	1K	2K	4K	8K
K_{ok}	14	5	0	-3	-6	-9	-14	-21

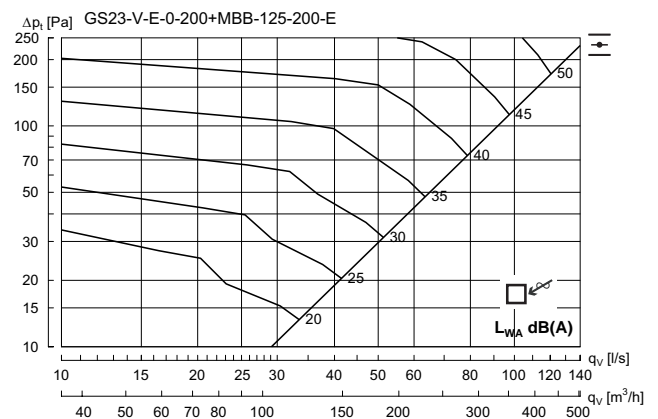

Hz	63	125	250	500	1K	2K	4K	8K
K_{ok}	9	4	1	-1	-6	-11	-15	-22

Versio

GS23

Technical data

GS23-V 250 + MBB - Exhaust air

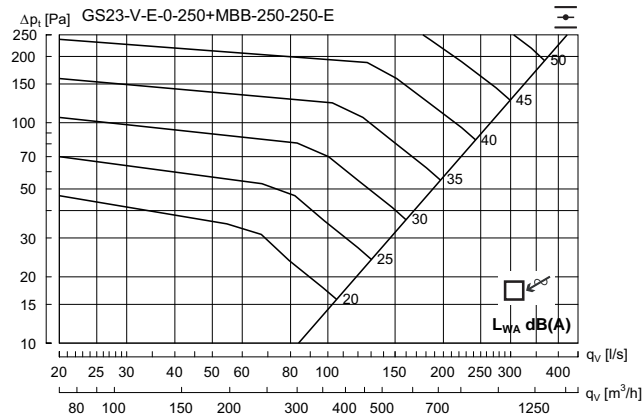

Hz	63	125	250	500	1K	2K	4K	8K
K_{ok}	10	5	2	-3	-6	-9	-15	-23

GS23-V 315 + MBB - Exhaust air

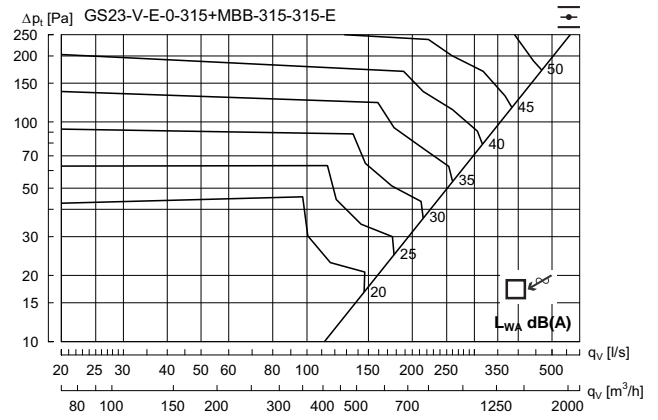

Hz	63	125	250	500	1K	2K	4K	8K
K_{ok}	11	5	3	-4	-7	-9	-14	-25

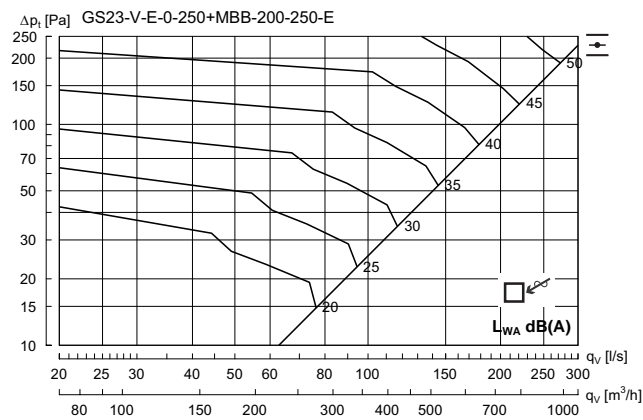

Hz	63	125	250	500	1K	2K	4K	8K
K_{ok}	13	5	1	-3	-6	-10	-14	-22

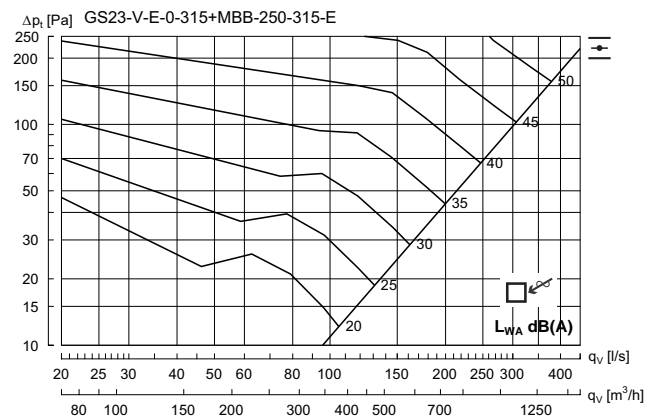

Hz	63	125	250	500	1K	2K	4K	8K
K_{ok}	11	5	2	-3	-6	-10	-15	-24

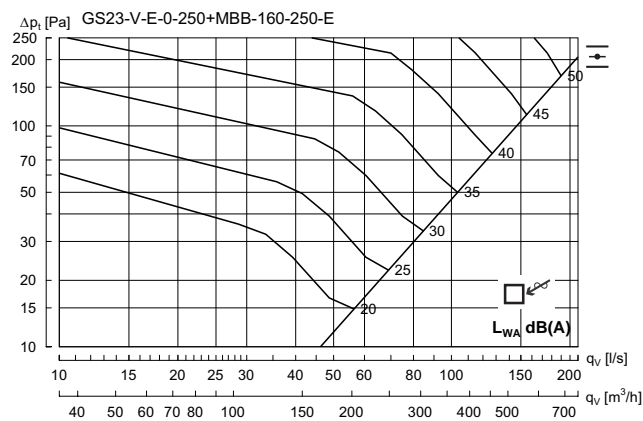

Hz	63	125	250	500	1K	2K	4K	8K
K_{ok}	13	5	1	-3	-6	-9	-14	-22

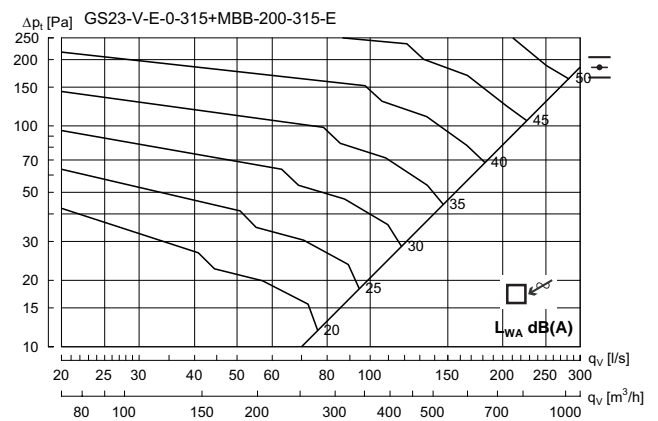

Hz	63	125	250	500	1K	2K	4K	8K
K_{ok}	13	5	1	-3	-6	-9	-14	-22



Versio

GS23

Technical data

Exhaust with plenum box type H

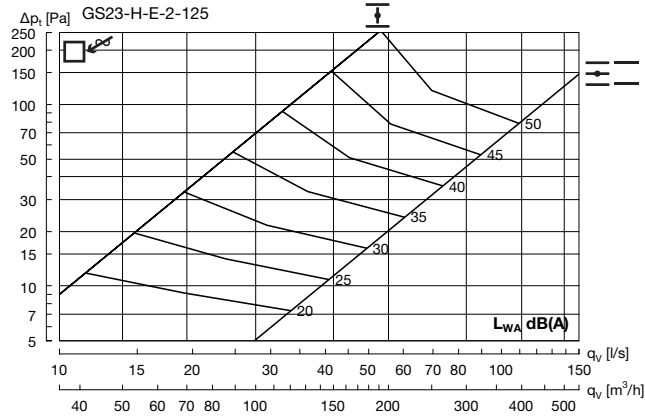

Hz	63	125	250	500	1K	2K	4K	8K
K_{ek}	4	4	5	-3	-9	-11	-18	-25

Exhaust with plenum box type H

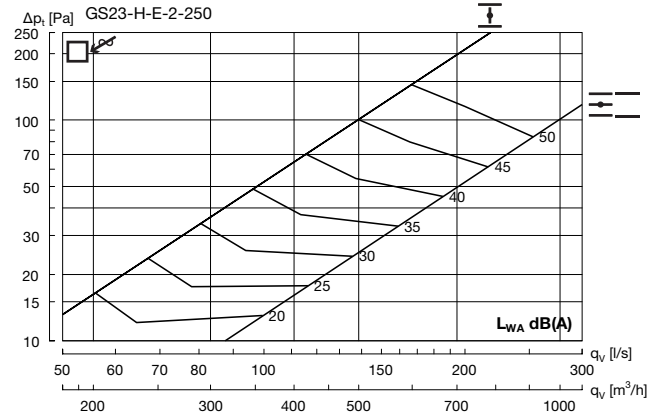

Hz	63	125	250	500	1K	2K	4K	8K
K_{ek}	3	6	2	-2	-6	-12	-21	-32

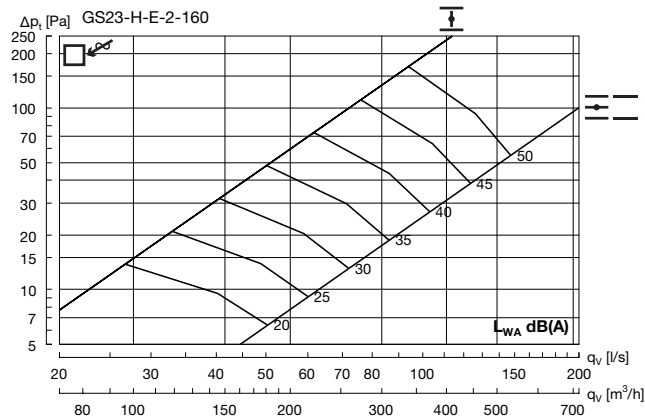

Hz	63	125	250	500	1K	2K	4K	8K
K_{ek}	6	4	6	-3	-10	-13	-20	-29

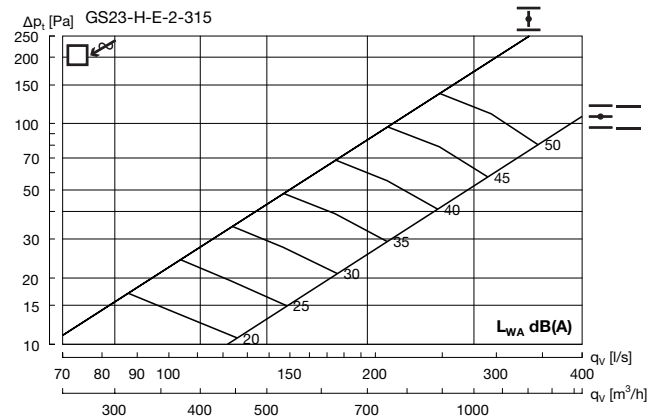

Hz	63	125	250	500	1K	2K	4K	8K
K_{ek}	10	6	2	-3	-5	-11	-20	-31

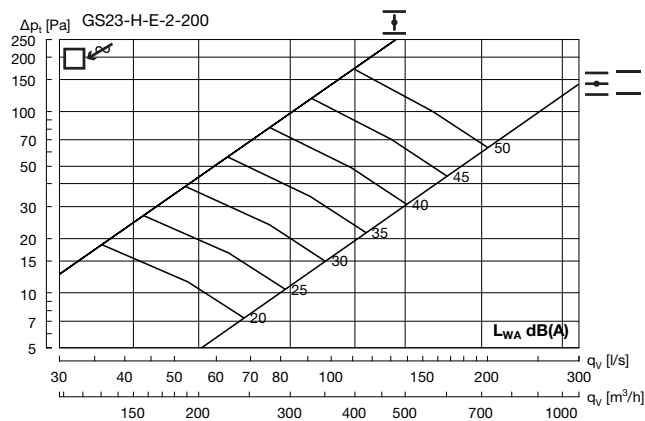

Hz	63	125	250	500	1K	2K	4K	8K
K_{ek}	8	5	4	-2	-8	-11	-19	-24

Lindab Lineo



1
2
3
4
5
6
7
8
9
10
11
12
13
14
15
16
17
18

MTL, Fingerrod C, Copenhagen Airport

Lindab Lineo

Slotdiffuser

1

2

3

4

5

6

7

8

9

10

11

12

13



14

15

16

17

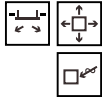
18

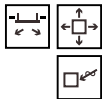
	Product	Functions	Page
	MTL		265
	STB STU		272

Lindab Lineo



MTL, Hotel Marriot, Copenhagen

Lindab Lineo

With the slim construction of the slotdiffuser, it is possible to obtain a very simple solution for your ventilation needs, which can be integrated in very different environments.

The slots can be mounted either in the ceiling or in the wall / skirting board. The best aero-technical qualities are obtained, when the slots are mounted in the middle of the room with a two-way supply of air. It is also a possibility to install the slots along the wall or along the facade, partly in order to make the installation seem as discrete as possible, and partly to free up the other part of the ceiling for other installations. The slots can be mounted in unbroken bands, where the best result is obtained when both active and passive - or exhaust-slots are combined in the same length.

Functionality

Lindab's slot diffuser MTL is available in two different widths, depending on the requirements for function or design. Furthermore, the corner pieces can be cut at an angle to suit. Normally the lengths are available in pieces up to 2 metres, but can be delivered in pieces up to 5 metres upon demand. If longer unbroken lengths are needed, the individual diffusers can be mounted with fixing-pipes. The plenum boxes STB and STU secure an even distribution and individual regulation of the slots.

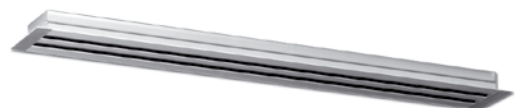

MTL, slot diffuser.

Linear diffuser

MTL

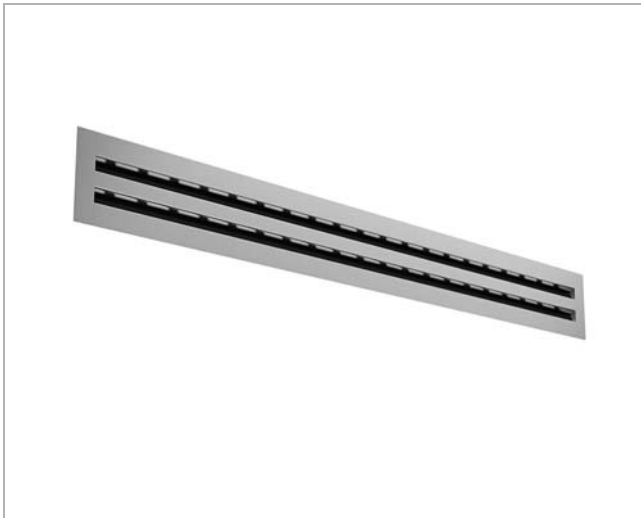

Description

MTL is a rectangular linear diffuser in aluminium. MTL is suitable for both supply and exhaust air. MTL is equipped with air guide baffles, making it possible to use MTL for horizontal supply air.

The horizontal dispersal pattern can be easily changed without the use of tools by turning the air guide baffle. The air guide baffle must be removed for vertical supply air.

MTL can be supplied in two versions, 15 mm or 19 mm, depending on capacity requirements or aesthetic considerations. MTL can be installed with plenum box STB/STU in order to achieve an even flow and individual adjustment.

MTL is normally supplied in lengths up to max. 2 m, but can be supplied on request up to 5 m. MTZ-1 is a 90° joint, when an aesthetically pleasing corner is required.

- Discrete appearance
- Used for both supply air and exhaust
- Horizontal and vertical supply air.

Maintenance

MTL can be removed to enable cleaning of internal parts or to gain access to the duct or box.

The visible parts of the diffuser can be wiped with a damp cloth.

Order code

Product Type	MTL	aa	b	cccc
Slot size	15	19		
No. of slots				
Length (L)				

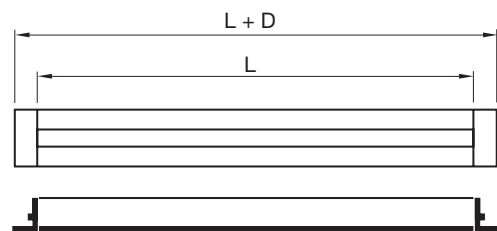
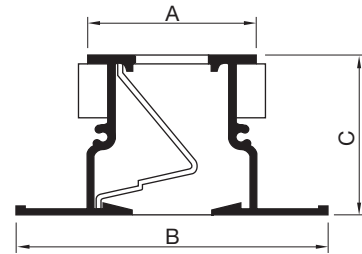

Both ends are equipped with flanges.

Slot width: 15 mm

No. of slots	A mm	B mm	C mm	D mm
1	25	45	25	30
2	50	70	25	30
3	75	95	25	30
4	100	120	25	30

Cutout: A + 10 mm x L + 10 mm

Slot width: 19 mm

No. of slots	A mm	B mm	C mm	D mm
1	40	75	38	56
2	79	113	38	56
3	117	151	38	56
4	157	189	38	56

Cutout: A + 20 mm x L + 20 mm

Materials and finish

Slot: Aluminium
 Standard finish: Natural anodised
 Air guide baffle: Black ABS plastic

The diffuser is available in other colours. Please contact Lindab's sales department for further information.

Linear diffuser

MTL

Accessories

MTZ-1

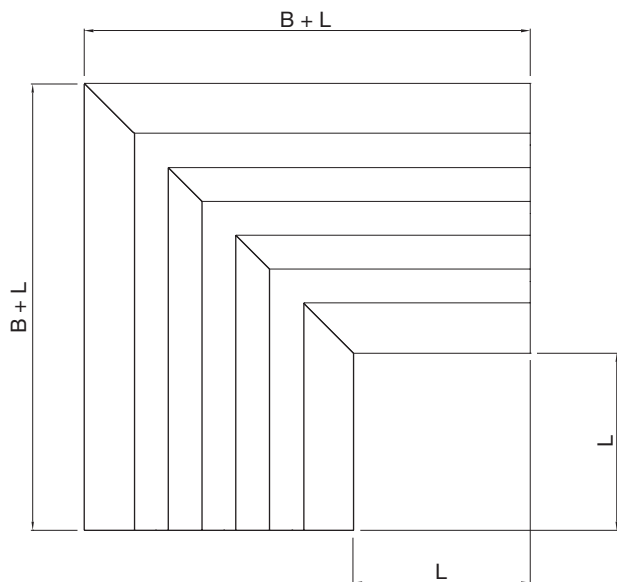

MTZ-1 15	L	B	MTZ-1 19	L	B
1	150	45	1	150	75
2	150	70	2	150	113
3	150	95	3	150	151
4	150	120	4	150	189

MTZ is supplied as two mitred ends (not one piece).

Order code

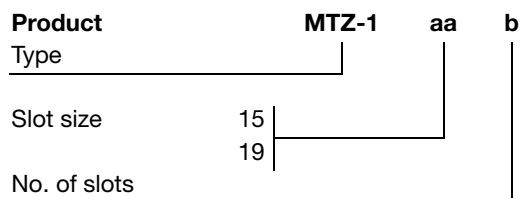

Installation in plenum box STB/STU

A self-tapping screw is fitted through the slot up into the perforated surface of the plenum box.

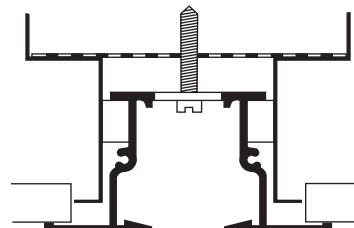

Installation of slots in continuous strips

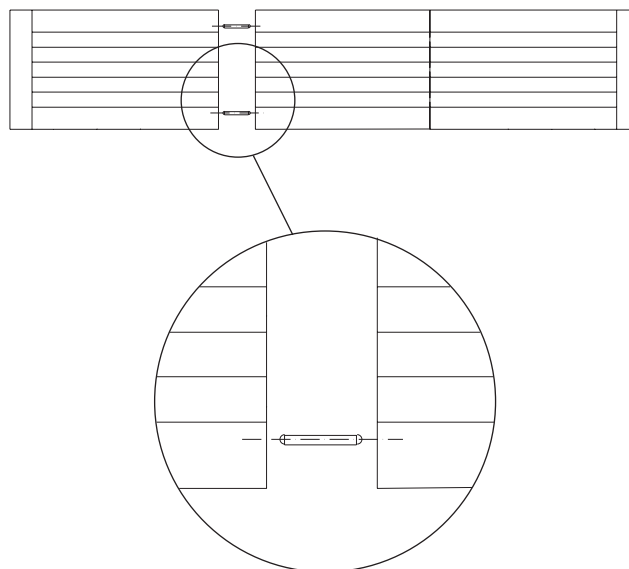

The slots are often installed in continuous strips, where there is a need to join the slots, so that it resembles a single piece. In these cases, the full length must be specified when ordering, and the slots will be supplied adjusted to the total length. The outermost pieces will be equipped with end pieces, and the middle pieces will be supplied without end pieces. The slots are joined using the accompanying pins.

Linear diffuser

MTL

Technical data

Capacity

Volume flow q_v [l/s] and [m³/h], total pressure Δp_t [Pa], throw $l_{0,2}$ [m] and sound power level L_{WA} [dB(A)] can be seen in the diagrams.

Throw $l_{0,2}$

Throw $l_{0,2}$ [m] at a speed of 0.2 m/s and 1 m slot length can be seen in the diagrams. Correction of throw at other slot lengths: see table 1.

Table 1: Correction of throw

Slot length	250	500	1000	1500	3000
Correction factor	0,7	0,85	1	1,1	1,2

Frequency-related sound effect level

The sound effect level in the frequency band is defined as $L_{WA} + K_{ok}$.
 K_{ok} values for MTL with box - see table 2.A and 2.B below.

Table 2.A: K_{ok} values [dB] for MTL with sloth width 15.

MTL-15-x + Box No. of slots (x)	Mean frequency Hz							
	63	125	250	500	1K	2K	4K	8K
1	8	3	6	-3	-10	-19	-27	-31
2	6	-1	5	-2	-8	-15	-23	-33
3	8	1	6	-2	-8	-17	-24	-31
4	6	-1	6	-2	-8	-15	-23	-31

Table 2.B: K_{ok} values [dB] for MTL with sloth width 19.

MTL-19-x + Box No. of slots (x)	Mean frequency Hz							
	63	125	250	500	1K	2K	4K	8K
1	11	8	6	-4	-12	-16	-23	-28
2	10	4	6	-4	-10	-15	-22	-28
3	8	2	7	-4	-11	-18	-24	-28
4	9	3	6	-3	-10	-16	-23	-27

Table 3: Correction for other slot lengths

Slot length	250	500	1000	1500	3000
correction [dB(A)]	-6	-3	0	2	5

Sound attenuation

Sound attenuation ΔL [dB] of MTL+STB including the end reflection, corresponding to the inlet diameter. See table 4 below.

Table 4: Sound attenuation ΔL [dB]

No. of slots	Mean frequency Hz							
	63	125	250	500	1K	2K	4K	8K
1	19	15	11	12	8	10	11	10
2	18	14	9	11	9	9	10	10
3	15	10	7	9	8	8	9	10
4	14	10	7	8	8	7	8	9

Balancing

Balancing data for control of air volume is available in a separate brochure.

Sample calculation:

Required data: Volume of air 200 m³/h
Throw 6.5 m
Horizontal supply air
Slot length 1.5 m, i.e. 133 [(m³/h)/m]

Solution: MTL 19

2-slot version is selected:
Throw according to diagram: 5.8 m

Throw correction according to table 1:
 $1.1 \times 5.8 = 6.4$ m
Pressure loss and sound level according

to diagram:

Open damper: 13 Pa, 15 dB(A)
Closed damper: 38 Pa, 22 dB(A)

Correction according to table 3:

Open damper: $15 + 2 = 17$ dB(A)
Closed damper: $22 + 2 = 24$ dB(A)

Linear diffuser

MTL

Technical data

Capacity

Volume flow q_v [l/s] and [m³/h], total pressure Δp_t [Pa], throw $l_{0,2}$ [m] and sound power level L_{WA} [dB(A)] can be seen in the diagrams.

Throw $l_{0,2}$

Throw $l_{0,2}$ [m] at a speed of 0.2 m/s and 1 m slot length can be seen in the diagrams. Correction of throw at other slot lengths: see table 1.

Table 1: Correction of throw

Slot length	250	500	1000	1500	3000
Correction factor	0,7	0,85	1	1,1	1,2

Frequency-related sound effect level

The sound effect level in the frequency band is defined as $L_{WA} + K_{ok}$.
 K_{ok} values for MTL with box - see table 2.A and 2.B below.

Table 2.A: K_{ok} values [dB] for MTL with sloth width 15.

MTL-15-x + Box No. of slots (x)	Mean frequency Hz							
	63	125	250	500	1K	2K	4K	8K
1	8	3	6	-3	-10	-19	-27	-31
2	6	-1	5	-2	-8	-15	-23	-33
3	8	1	6	-2	-8	-17	-24	-31
4	6	-1	6	-2	-8	-15	-23	-31

Table 2.B: K_{ok} values [dB] for MTL with sloth width 19.

MTL-15-x + Box No. of slots (x)	Mean frequency Hz							
	63	125	250	500	1K	2K	4K	8K
1	11	8	6	-4	-12	-16	-23	-28
2	10	4	6	-4	-10	-15	-22	-28
3	8	2	7	-4	-11	-18	-24	-28
4	9	3	6	-3	-10	-16	-23	-27

Table 3: Correction for other slot lengths

Slot length	250	500	1000	1500	3000
correction [dB(A)]	-6	-3	0	2	5

Sound attenuation

Sound attenuation ΔL [dB] of MTL+STB including the end reflection, corresponding to the inlet diameter. See table 4 below.

Table 4: Sound attenuation ΔL [dB]

No. of slots	Mean frequency Hz							
	63	125	250	500	1K	2K	4K	8K
1	19	15	11	12	8	10	11	10
2	18	14	9	11	9	9	10	10
3	15	10	7	9	8	8	9	10
4	14	10	7	8	8	7	8	9

Balancing

Balancing data for control of air volume is available in a separate brochure.

Sample calculation:

Required data: Volume of air 200 m³/h
Throw 6.5 m
Horizontal supply air
Slot length 1.5 m, i.e. 133 [(m³/h)/m]

Solution: MTL 19

2-slot version is selected:
Throw according to diagram: 5.8 m

Throw correction according to table 1:
 $1.1 \times 5.8 = 6.4$ m
Pressure loss and sound level according

to diagram:

Open damper: 13 Pa, 15 dB(A)
Closed damper: 38 Pa, 22 dB(A)

Correction according to table 3:

Open damper: $15 + 2 = 17$ dB(A)
Closed damper: $22 + 2 = 24$ dB(A)

Linear diffuser

MTL

Technical data

Horizontal supply air

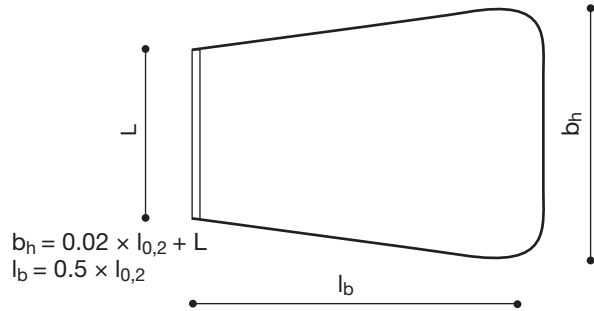
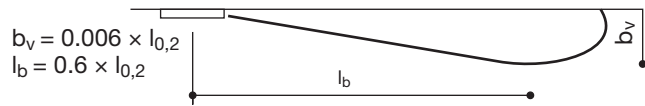

Vertical supply air

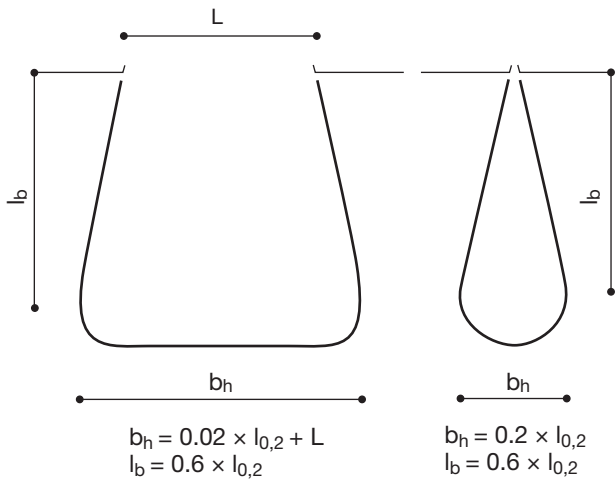

Throw MTL 15

Horizontal

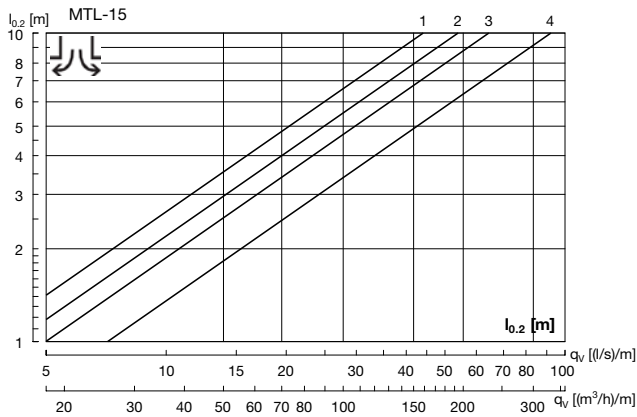

Vertical

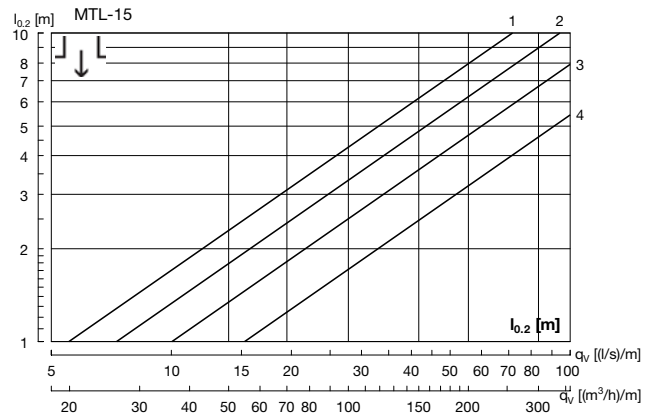

Throw MTL 19

Horizontal

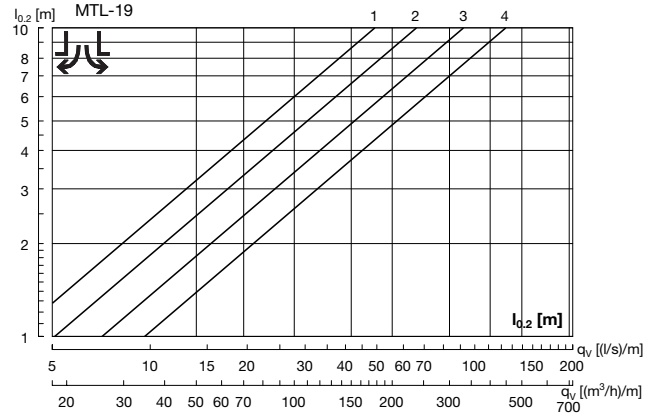

Vertical

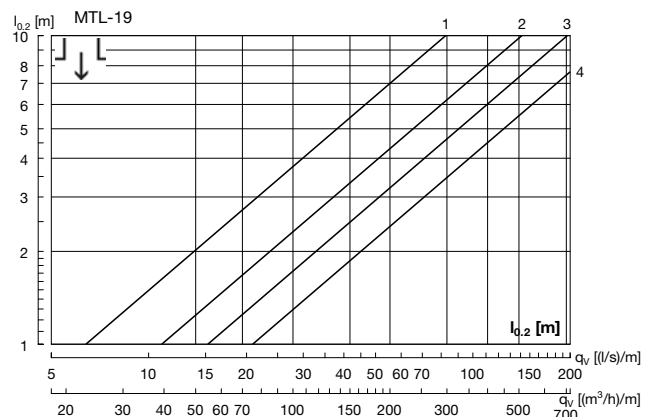

Linear diffuser

MTL

Horizontal-supply

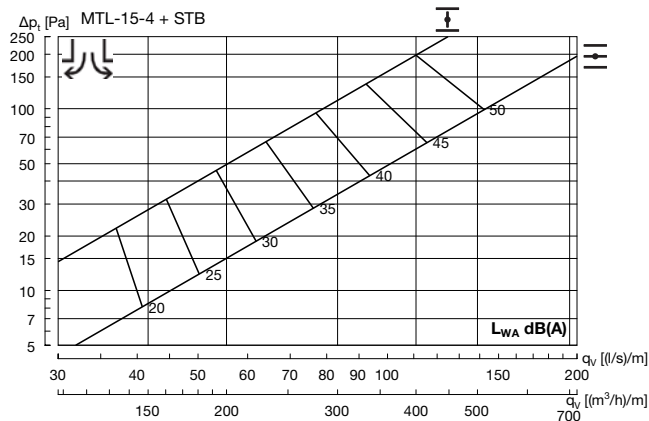
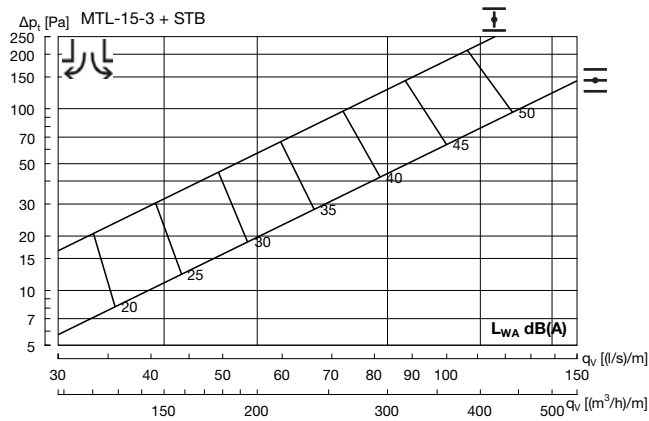
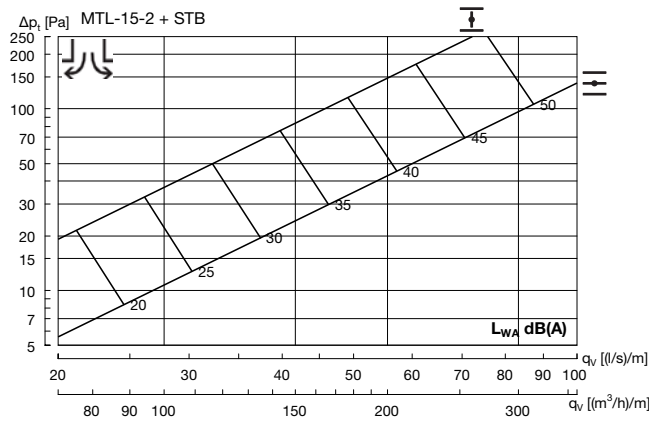
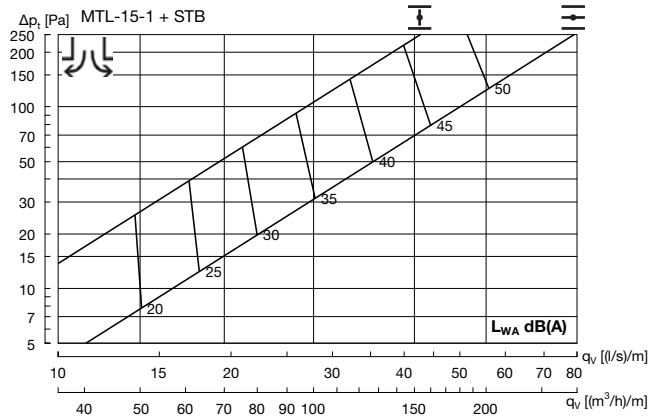

Vertical-supply

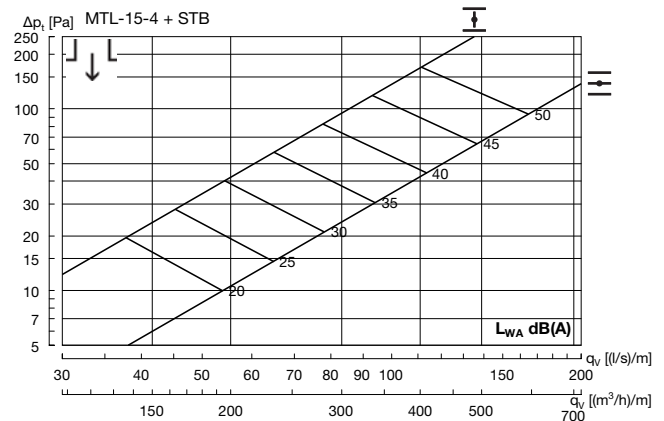
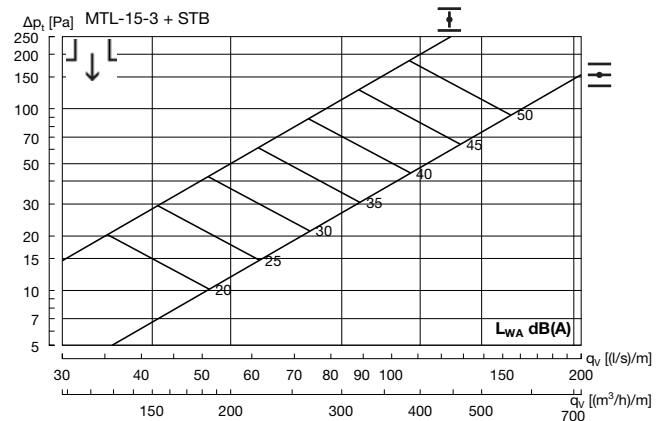
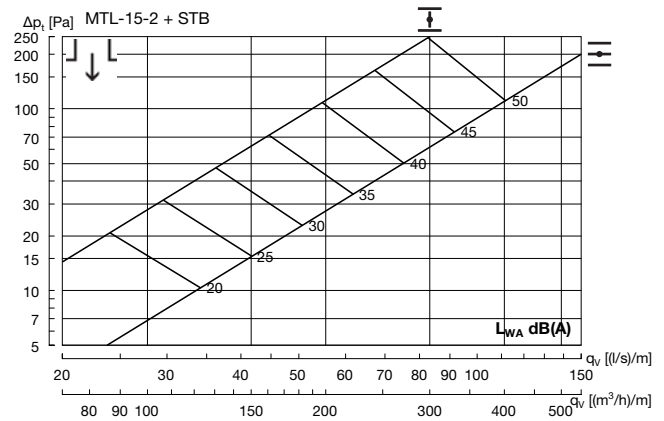
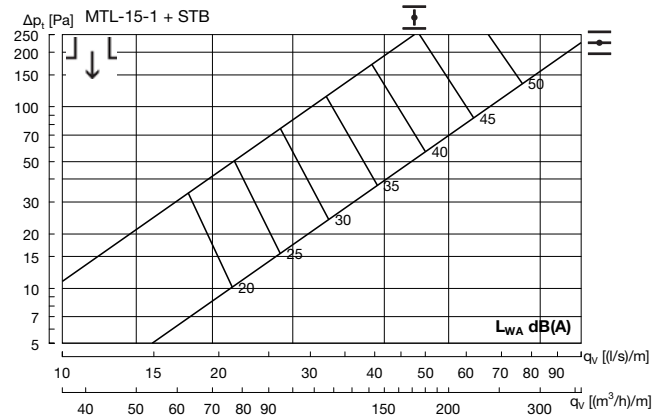

- 1
- 2
- 3
- 4
- 5
- 6
- 7
- 8
- 9
- 10
- 11
- 12
- 13
- 14
- 15
- 16
- 17
- 18

Linear diffuser

MTL

Horizontal-supply

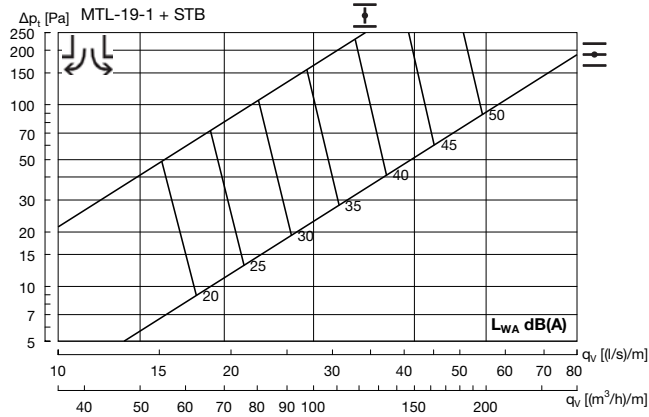

Vertical-supply

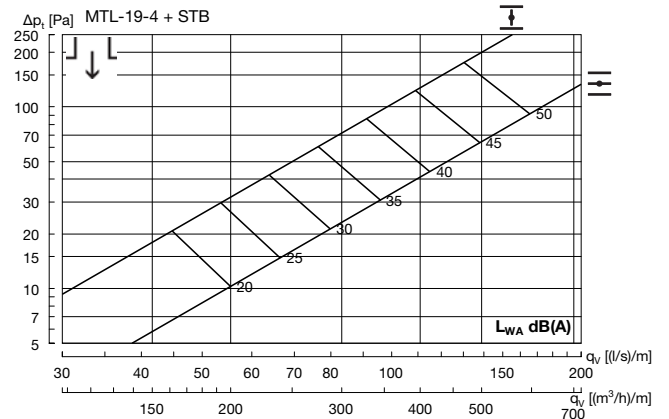
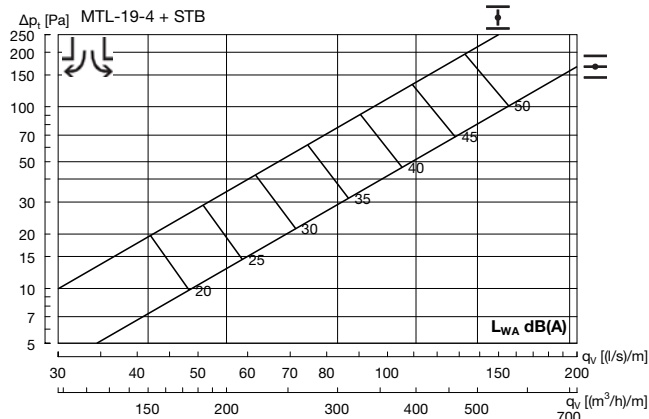
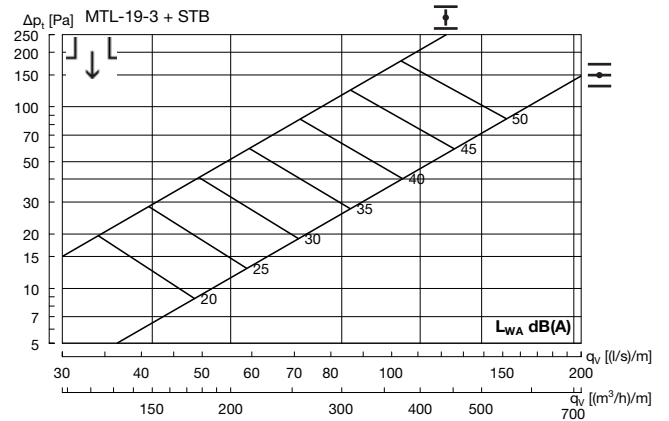
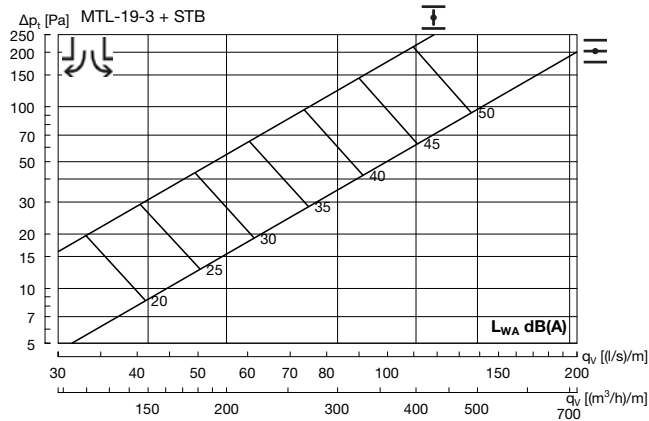
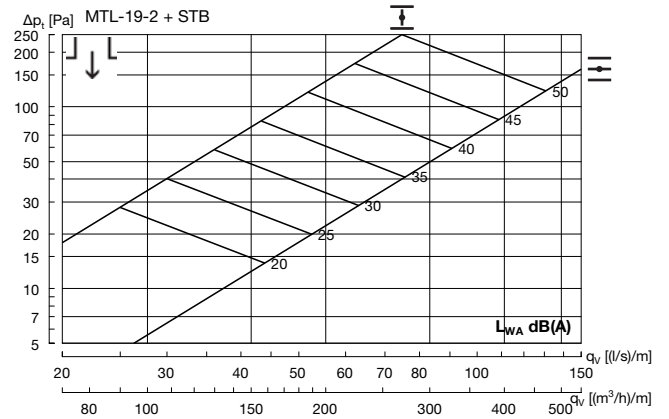
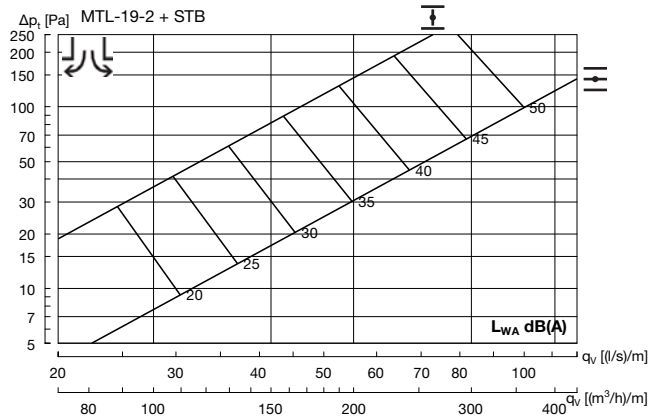
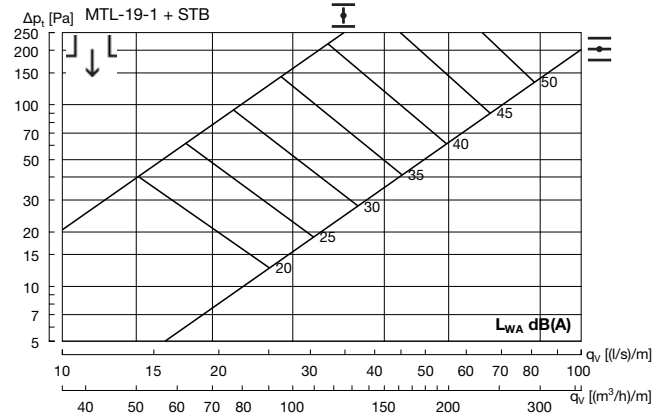

Linear diffuser

MTL

Exhaust air- MTL 15

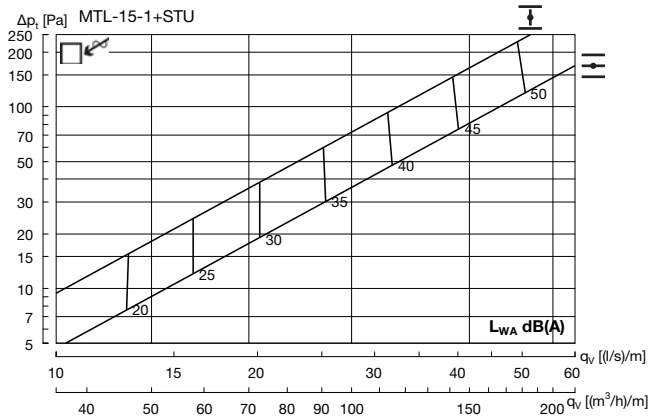

Exhaust air- MTL 19

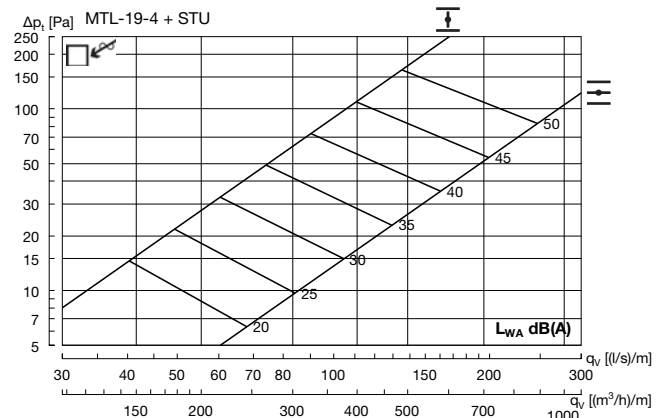
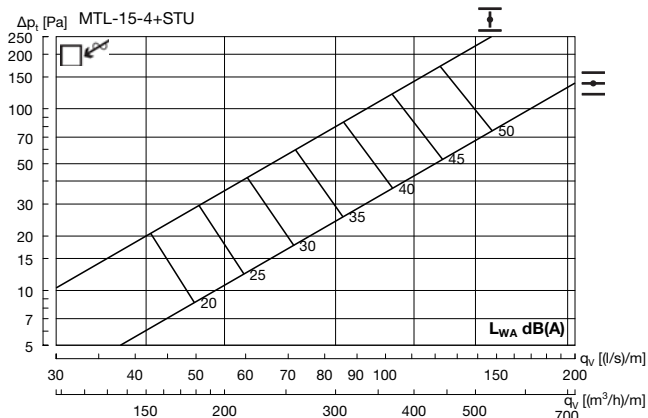
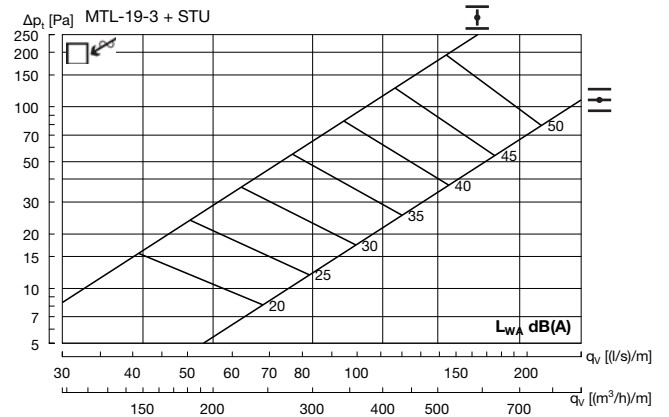
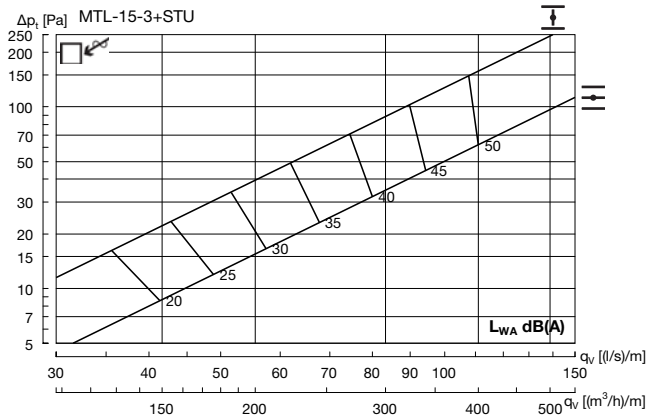
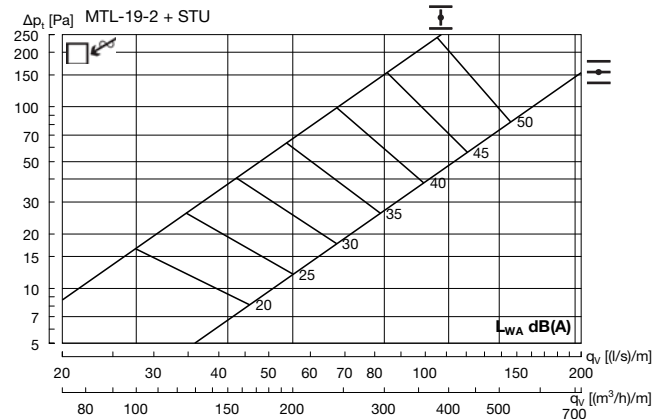
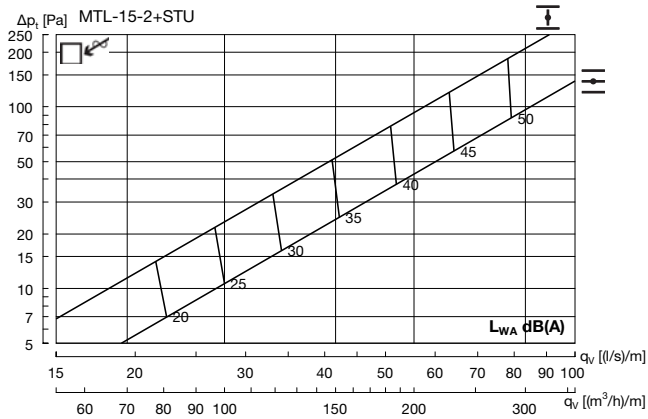
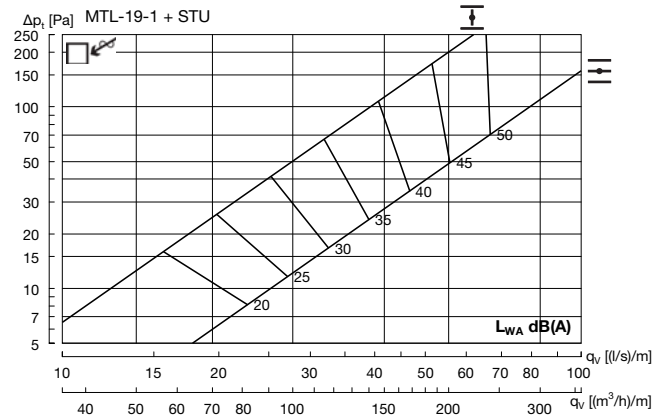

- 1
- 2
- 3
- 4
- 5
- 6
- 7
- 8
- 9
- 10
- 11
- 12
- 13
- 14
- 15
- 16
- 17
- 18

Plenum box

STB/STU



Description

STB is a rectangular plenum box for supply air for linear diffuser, MTL. The plenum box ensures even distribution over the linear diffuser. STB is equipped with a damper and an orifice plate to ensure individual regulation, and is supplied with acoustic insulation.

STU is a rectangular plenum box for air exhaust for linear diffuser, MTL. STU has the same properties as STB.

- Ensures even air distribution over the linear diffuser.
- Acoustically insulated.
- Supplied with damper and measuring device

Order code

Product	STB/STU	a	ba	ccc
Type				
Slot size	15			
	19			
No. of slots				
Length				

Dimensions

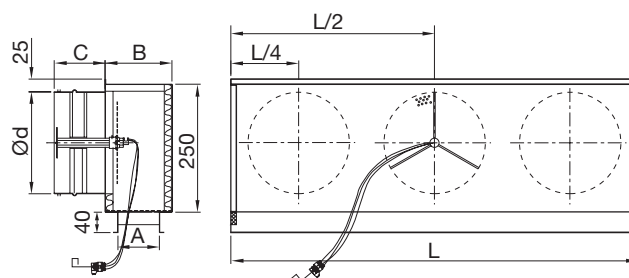

Box type / Length		0-1199		1200-1799		1800-2000				
No. of slots	Slot size				Ød	No.	Ød	No.	Ød	No.
	15		19							
	A	B	A	B						
1	26	90	41	91	125	1	160	1	125	2
2	51	100	80	130	160	1	200	1	160	2
3	76	125	118	168	200	1	200	2	200	2
4	101	150	158	208	200	1	200	2	200	2

C dimension: STB = 100 mm
STU = 200 mm

Materials and finish

Plenum box: Galvanised steel
Standard finish: Galvanised steel
Insulation: Melamine foam plastic

Perforated exhaust plate

PKY/PCY

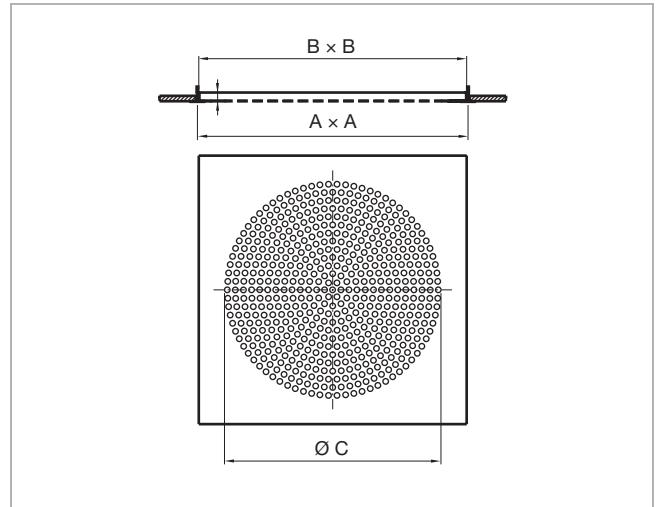
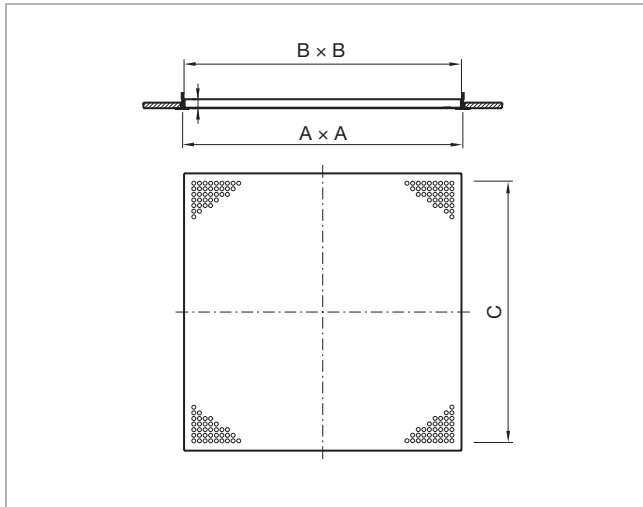

Description

PKY/PCY is a “diffuser” without duct connection for installation in T-rail ceilings. PKY/PCY is used in situations where air is to be exhausted over a suspended ceiling, and a sufficient opening is required in the ceiling for the air to pass through.

- Architecturally and financially attractive “diffuser” solution for exhaust of air over a suspended ceiling
- Can be adapted for many different types of ceiling
- Low pressure loss and large air capacity

Maintenance

The visible parts of the diffuser can be wiped with a damp cloth.

Materials and finish

Material: Galvanised steel
 Standard finish: Powder-coated
 Standard colour: RAL 9010, gloss 30

The diffuser is available in other colours. Please contact Lindab’s sales department for further information.

Order code

Product **PKY** **aaa**
 Type _____
 Size _____

Ceiling system - see introductory summary.

Dimensions

PKY

A Size	B mm	C mm	Free area m ²	Curve no.	Weight kg
500	495	467	0,085	1	1,3
600	595	567	0,125	2	1,8
625	620	597	0,138	3	1,9

PCY

A Size	B mm	C mm	Free area m ²	Curve no.	Weight kg
500	495	400	0,043	4	1,6
600	595	490	0,064	5	2,1
625	620	490	0,064	5	2,2

Pressure loss [Pa]

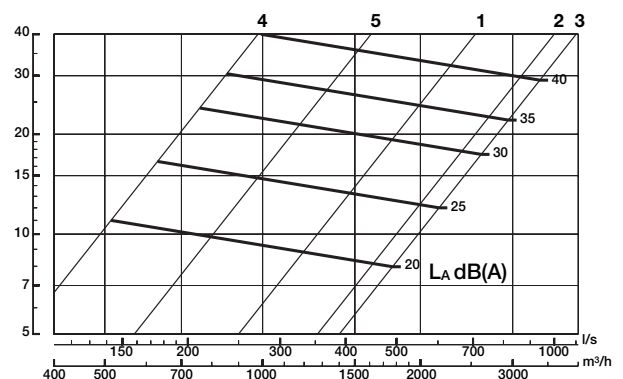

Ceiling tile adaption

Overview

1. T24/T15 Lay-in **278**

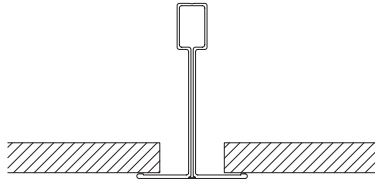

2. T24/T15 Lay-in not cleanable **279**

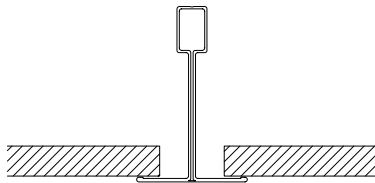

3. Permanent ceiling **279**



4. Dampa Clip-in bevelled edge **280**

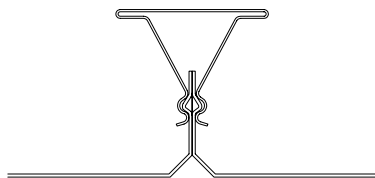

5. Dampa Clip-in square edge **281**

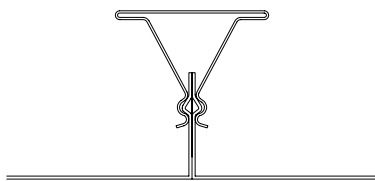

6. Luxalon Clip-in **282**

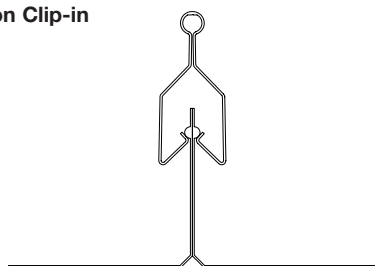

7. Danotile Contur Ecophon D Rockfon D-XL **283**

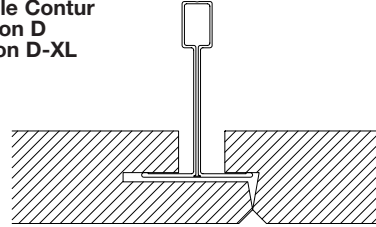

8. Ecophon Focus DG **284**

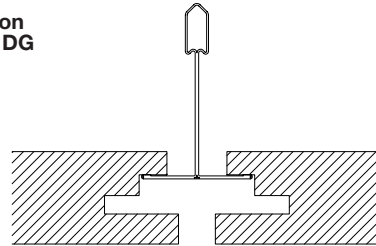

9. Rockfon E10 24 Ecophon E / T24 **285**

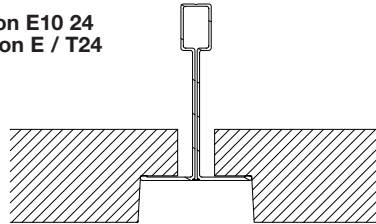

10. Rockfon E10 15 Ecophon E / T15 **286**

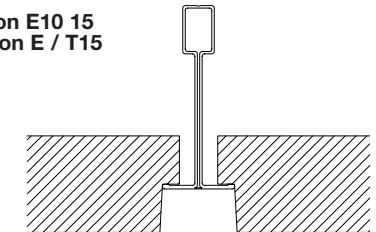

11. Danotile Markant **287**

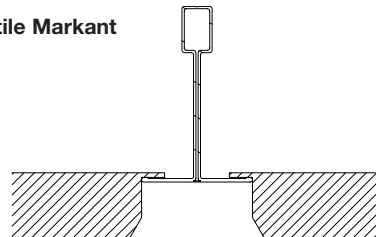

14. Ecophon Focus Edge DS **288**

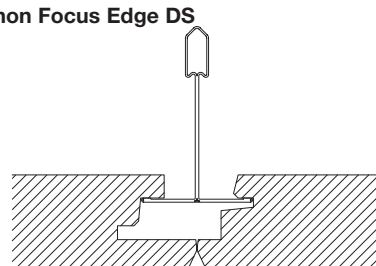

Ceiling tile adaption



Versio, Competence centre, Hobro.

Ceiling systems

A harmonic and aesthetic ceiling solution with beautifully integrated components is a must in modern constructions. The individual components themselves define the appearance of the final solution. Lindab contributes to the holism by adapting the diffusers to most 600x600 ceiling systems. In this way the holism of the solution is maintained, and the final result will become just as planned.

Ceiling adaption

Most of Lindab's ceiling diffusers can be adapted to 600x600 ceiling systems. The individual diffusers are adapted to the ceiling system directly in the grille box, or by using adapted module plates / frames, depending on which ceiling system is chosen. The following pages show Lindab's standard offering; both in terms of face plates and ceiling tile adaptations.

In the back of this chapter is an overview of adapted module plates.

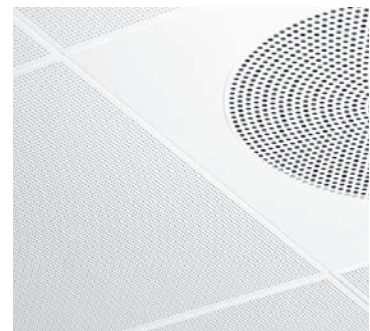

PC7 diffuser.

Ceiling tile adaption

Design

See [Comfort and design](#)



Ceiling systems

1, 3, 7, 8, 9, 10, 11, 14



Product

	Perforated	Pattern 600	Pattern 500	Pattern 400	Pattern 300
PS	1 - 11				
	Swirl	Pattern 600	Pattern 500	Pattern 400	Pattern 300
RS	14 - 16				
	Nozzles	Pattern 600	Pattern 500	Pattern 400	Pattern 300
NS	19				
	Grid	Pattern 600	Pattern 500	Pattern 400	Pattern 300
GS	23				
	Frame	Pattern 600	Pattern 500	Pattern 400	Pattern 300
R					

No.	Ceiling type	Pattern							
		600		500		400		300	
		R mm	A x A mm	R mm	A x A mm	R mm	A x A mm	R mm	A x A mm
1	Lay-in 24/15 T-rack	595	564	595	464	595	383	595	383
3	Permanent ceiling	595	564	495	464	415	383	415	383
7	Hidden T-bar	*	599	599	464	599	383	599	383
8	Partially visible t-rack T24	*	592	592	464	592	383	592	383
9	T24 E/markant	*	575	595	464	595	383	595	383
10	T15 E/markant	*	584	584	464	584	383	584	383
11	T24 Markant	*	575	575	464	575	383	575	383
14	Ecophon Focus edge DS	*	599	599	464	599	383	599	383
Connection diffuser/box		Ød mm	U mm	Ød mm	U mm	Ød mm	U mm	Ød mm	U mm
Grille box type V		315	575	250	475	200	395	160	395
Plenum box type H		250/315	575	200	475	160	395	125	395
Rectangular connection		A x B mm	U mm	A x B mm	U mm	A x B mm	U mm	A x B mm	U mm
Plenum box type R		498 x 98	575	398 x 98	475	298 x 98	395	198 x 98	395

* shows solutions without fame, A x A shows face plate measurement in mm, R shows measurements on frame around the face plate. U shows recess.

Ceiling tile adaption

Design

See [Comfort and design](#)



Ceiling systems

2, 4, 5, 6



Product

	Perforated	Pattern 600	Pattern 500	Pattern 400	Pattern 300
PS	1 - 11				
RS	14 - 16				
NS	19				
GS	23				

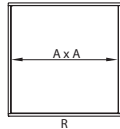

A x A shows face plate dimension, A x A is the outer dimension of all face plates.

No.	Ceiling type	Pattern			
		600	500	400	300
		A x A mm	A x A mm	A x A mm	A x A mm
2	Lay-in 24/15 T-rack not cleanable	595	595	595	595
4	Clip-in bevelled edge	600	600	600	600
5	Clip-in square edge	600	600	600	600
6	Clip-in	600	600	600	600
Connection diffuser/box		Ød mm	Ød mm	Ød mm	Ød mm
Grille box type V		315	250	200	160
Plenum box type H		250/315	200	160	125
Rectangular connection		A x B mm	A x B mm	A x B mm	A x B mm
Plenum box type R		498 x 98	398 x 98	298 x 98	198 x 98

A x A shows face plate measurements in mm

1

2

3

4

5

6

7

8

9

10

11

12

13

14

15

16

17

18

Ceiling tile adaption

1. Ceiling adaption T24/T15 Lay-in

Lindab's ceiling diffusers adapted to T 24 / T15 Lay-in is mounted directly in the ceiling system as depicted in the sketches. The diffuser is delivered with a detachable face plate, so full access to the plenum box and the air duct is possible.

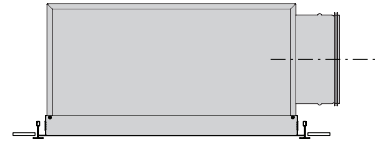

Sketch Versio- V, H, R pattern 300,400,500

(PBB mounting brackets not included, can be ordered separately.)

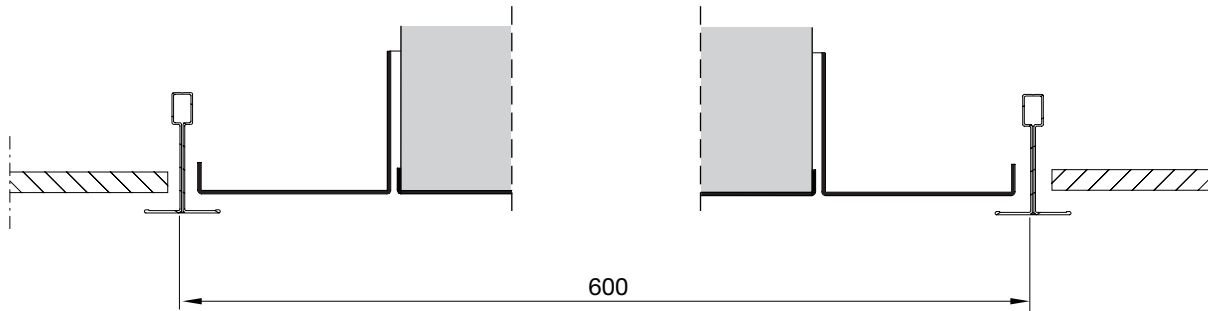

Sketch Versio- V, H, R pattern 600

(PBB mounting brackets not included, can be ordered separately.)

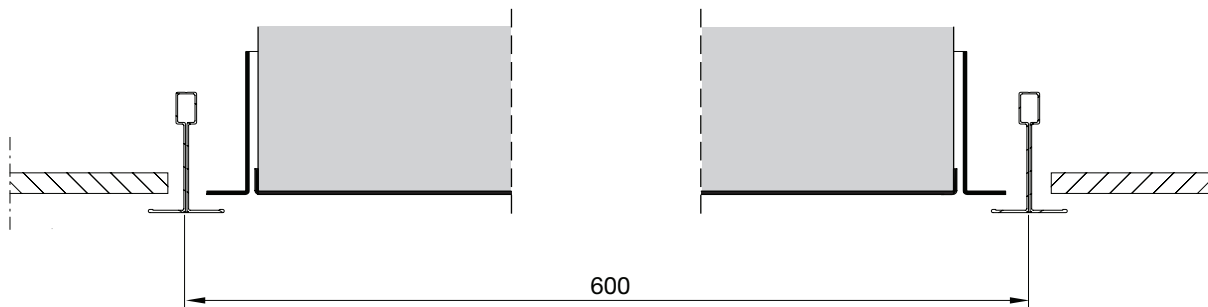

Sketch moduleplate type LM- Integra/Formo

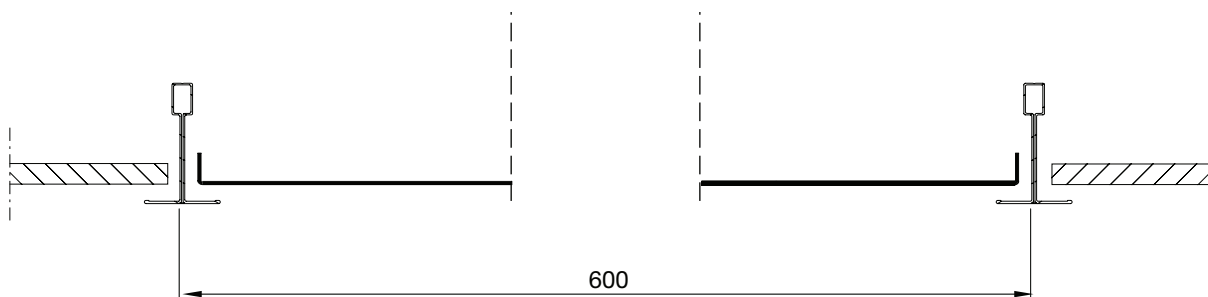

Ceiling tile adaption

2. Ceiling adaption T24/ T15 Lay-in not cleanable

Lindab's diffuser adapted to T 24 / T15 Lay-in is mounted directly in the ceiling system, as depicted on the sketches. The face plate is in one piece and cannot be detached unless the diffuser is demounted from the rack-system.

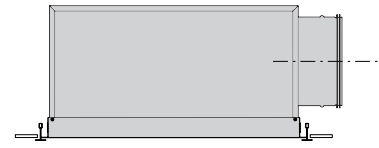

Sketch Versio- V, H, R all sizes

(PBB mounting brackets not included, can be ordered separately.)

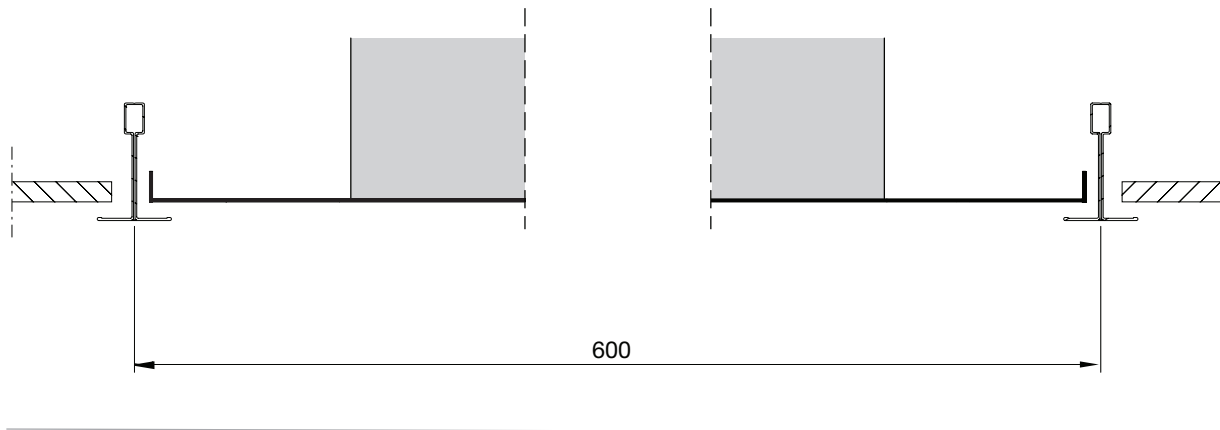

3. Permanent ceiling

Lindab's diffuser adapted to permanent ceiling is cut directly into the ceiling construction. The diffuser can be fastened with Lindab's different types of mounting brackets, see product pages for more details.

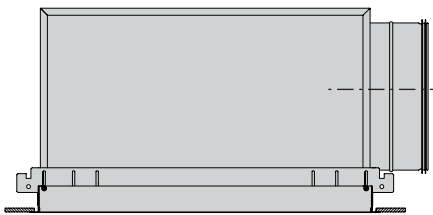

Plenum box type H including mounting bracket type PBB

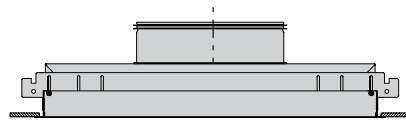

Grille box type V including mounting bracket type PBB

Sketch Versio- V, H, R all sizes

(PBB mounting brackets included as standard.)

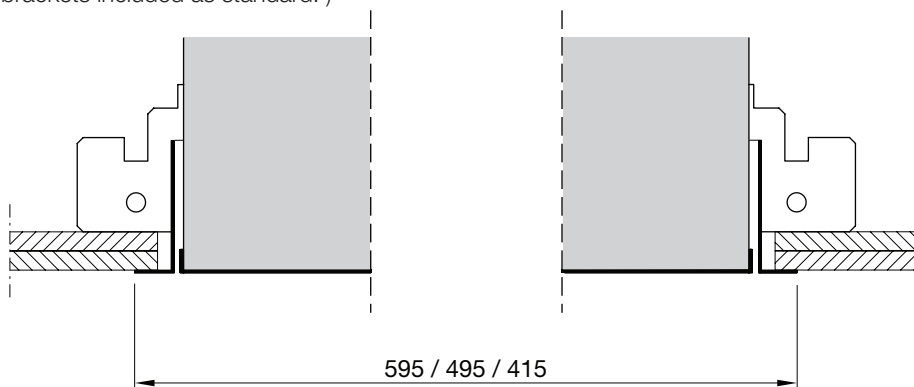

- 1
- 2
- 3
- 4
- 5
- 6
- 7
- 8
- 9
- 10
- 11
- 12
- 13
- 14
- 15
- 16
- 17
- 18

Ceiling tile adaption

4. Dampa Clip-in bevelled edge

Lindab's diffuser adapted to Dampa Clip-in bevelled edge is mounted directly in the ceiling system, as depicted in the sketches.

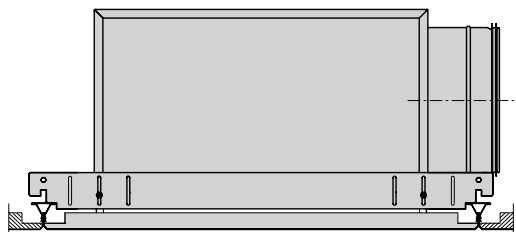

Plenum box type H including mounting bracket type PBB

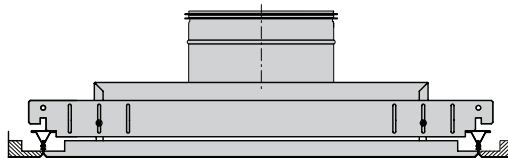

Grille box type V including mounting bracket type PBB

Sketch Versio- V, H, R all sizes

(PBB mounting brackets included as standard.)

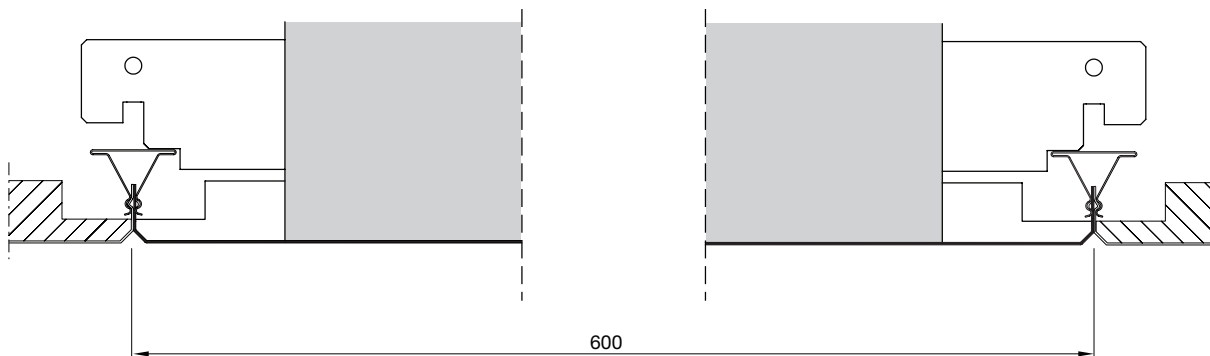

Sketch moduleplate type LM- Integra/Formo

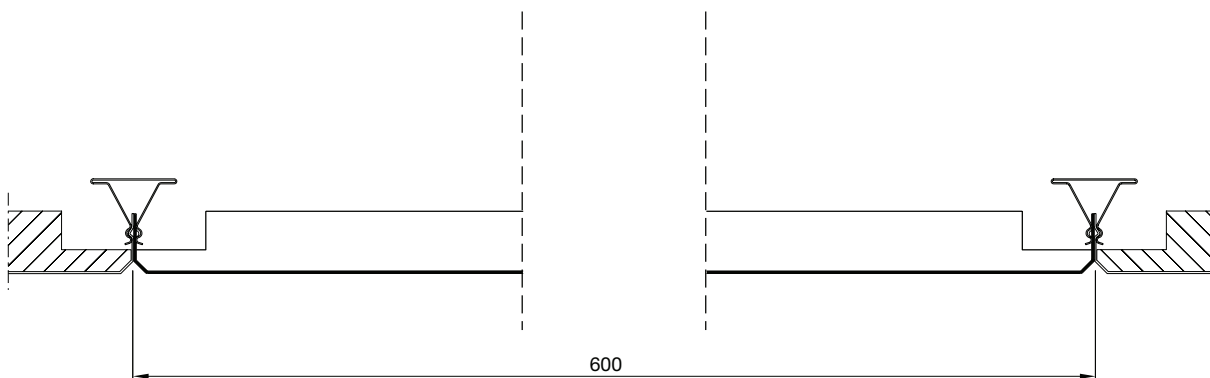

Ceiling tile adaption

5. Dampa Clip-in square edge

Lindab's diffuser adapted to Dampa Clip-in square edge is mounted directly in the ceiling system, as depicted in the sketches.

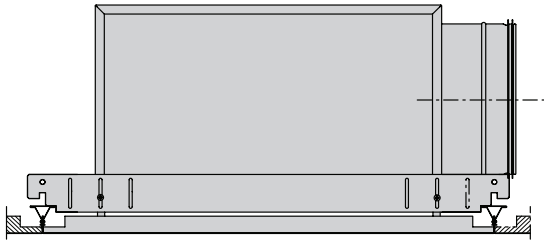

Plenum box type H including mounting brackets type PBB

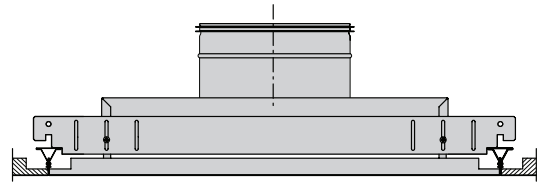

Grille box type V including mounting bracket type PBB

Sketch Versio- V, H, R all sizes

(PBB mounting brackets included as standard.)

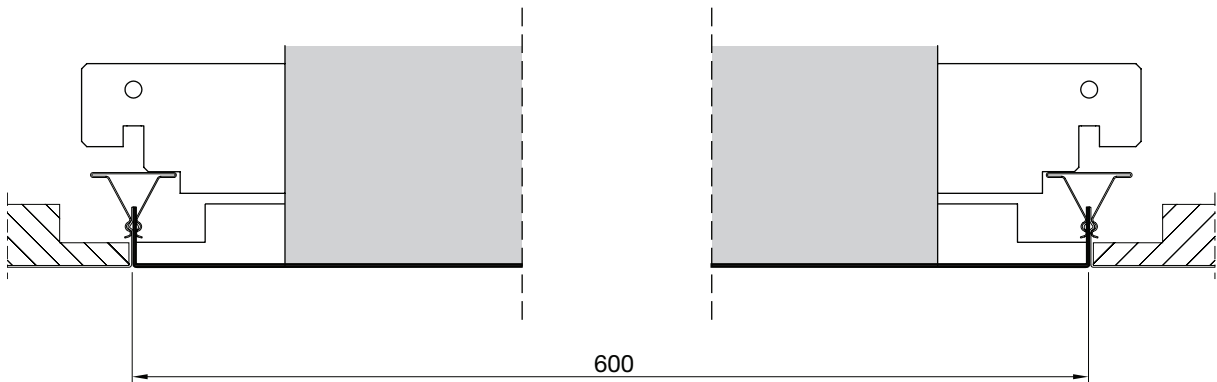

Sketch moduleplate type LM- Integra/Formo

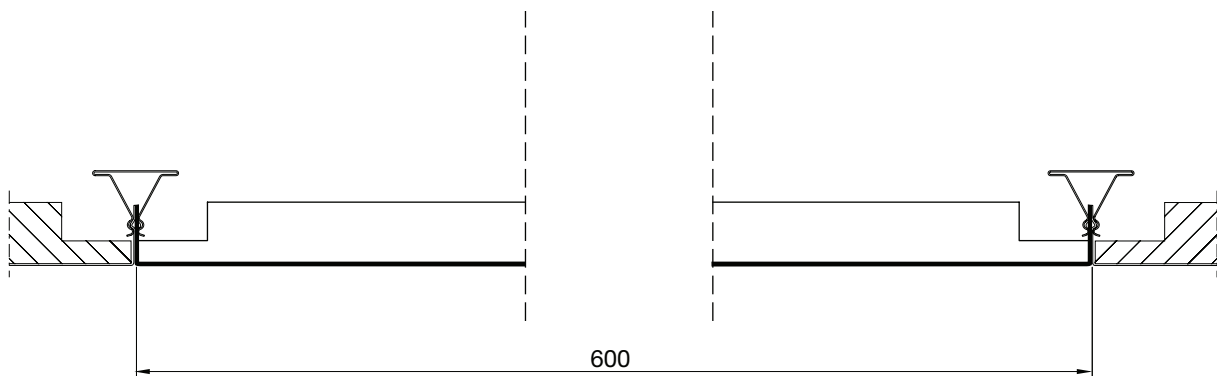

1
2
3
4
5
6
7
8
9
10
11
12
13
14
15
16
17
18

Ceiling tile adaption

6. Luxalon Clip-in

Lindab's diffuser adapted to Luxalon Clip-in is mounted directly in the ceiling system, as depicted in the sketches.



Plenum box type H including mounting bracket type PBB

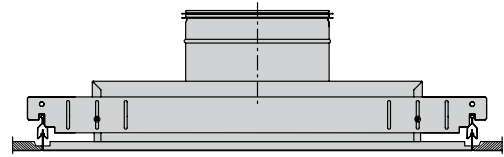

Grille box type V including mounting bracket type PBB

Sketch Versio- V, H, R all sizes

(PBB mounting brackets included as standard.)

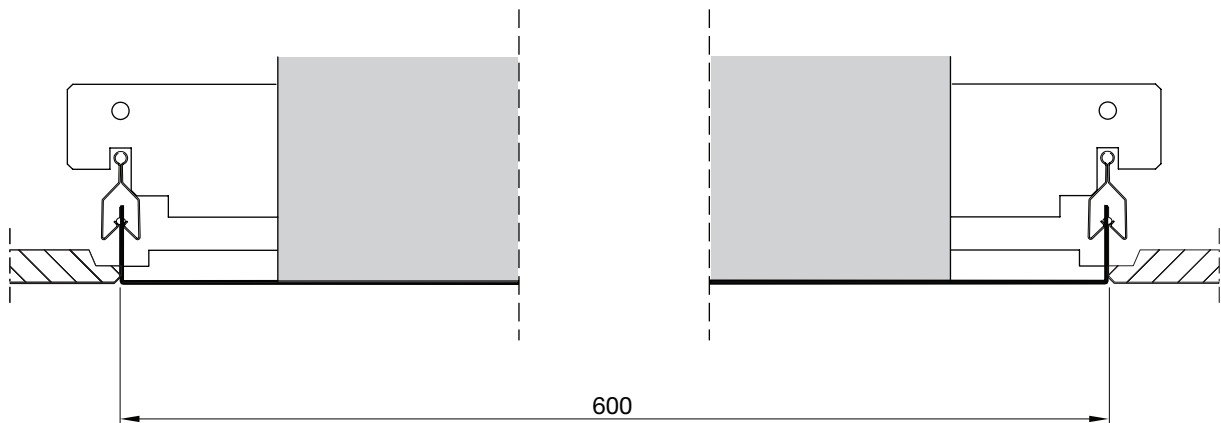

Sketch moduleplate type LM- Integra/Formo

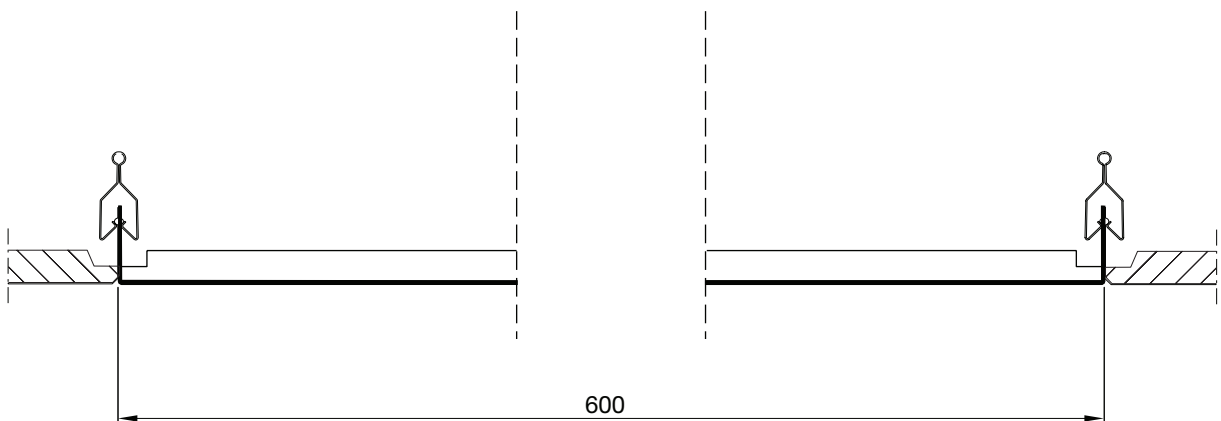

Ceiling tile adaption

7. Danotile Contur, Ecophon D and Rockfon D-XL

Lindab's diffuser adapted to the above mentioned ceiling systems, is mounted directly in the ceiling system, as depicted in the sketches.

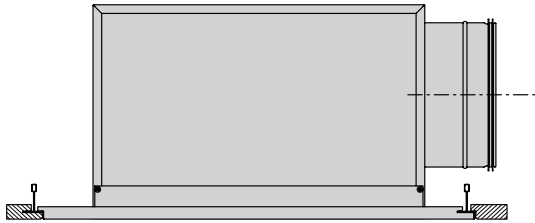

Plenum box type H

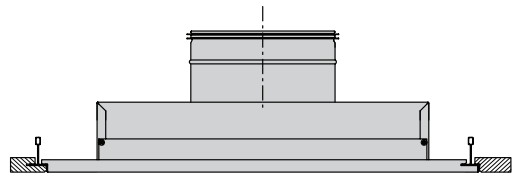

Grille box type V

Sketch Versio- V, H, R pattern 300, 400, 500

(PBB mounting brackets not included, can be ordered separately.)

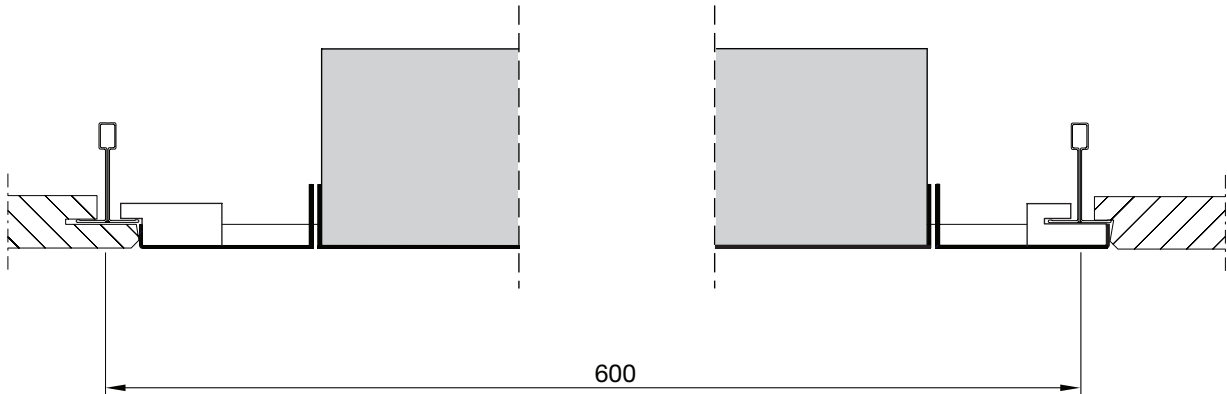

Sketch Versio- V, H, R pattern 600

(PBB mounting brackets included as standard.)

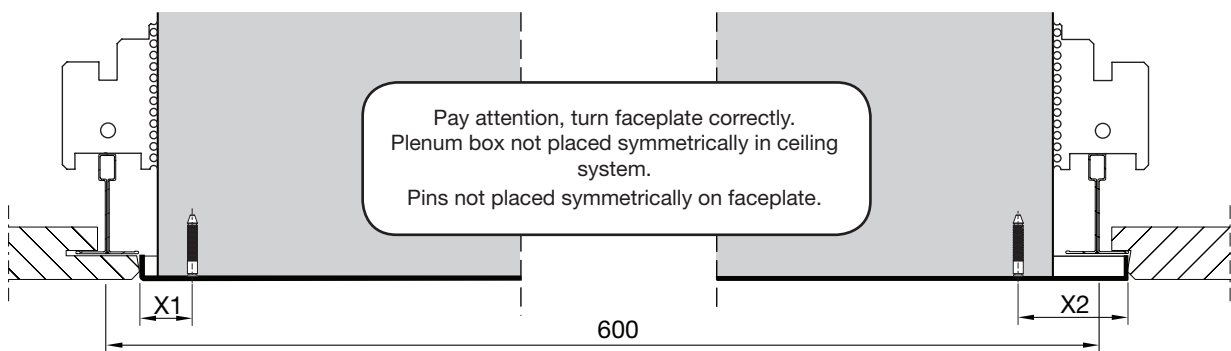

Sketch moduleplate type LM- Integra/Formo

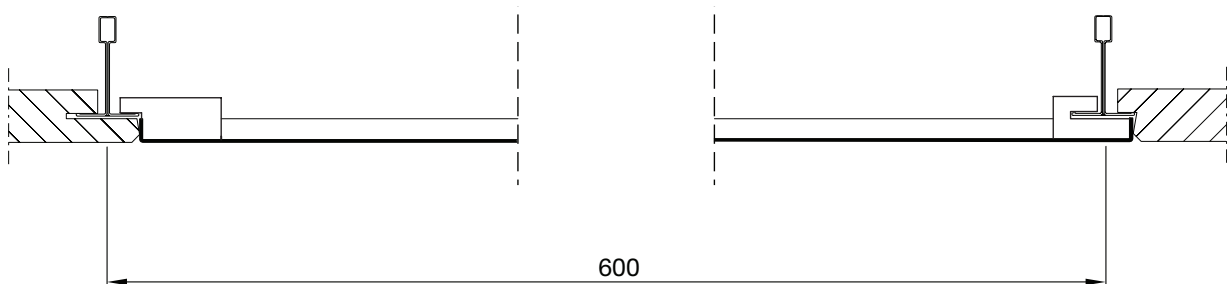

- 1
- 2
- 3
- 4
- 5
- 6
- 7
- 8
- 9
- 10
- 11
- 12
- 13
- 14
- 15
- 16
- 17
- 18

Ceiling tile adaption

8. Ecophon Focus DG

Lindab's diffuser adapted to Ecophon Focus DG ceiling systems are mounted directly in the ceiling system, as depicted in the sketches.

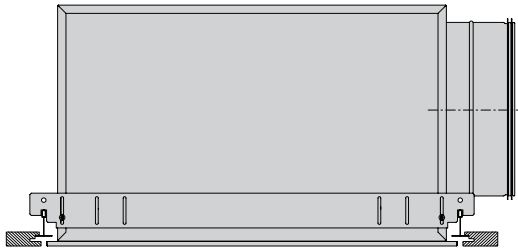

Plenum box type H including mounting bracket type PBB

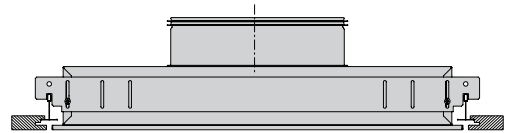

Grille box type V including mounting bracket type PBB

Sketch Versio- V, H, R pattern 300, 400, 500

(PBB mounting brackets not included, can be ordered separately.)

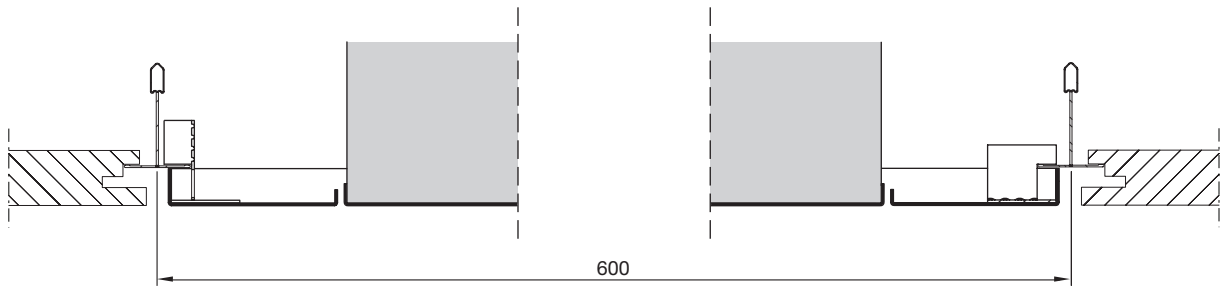

Sketch Versio- V, H, R pattern 600

(PBB mounting brackets included as standard.)

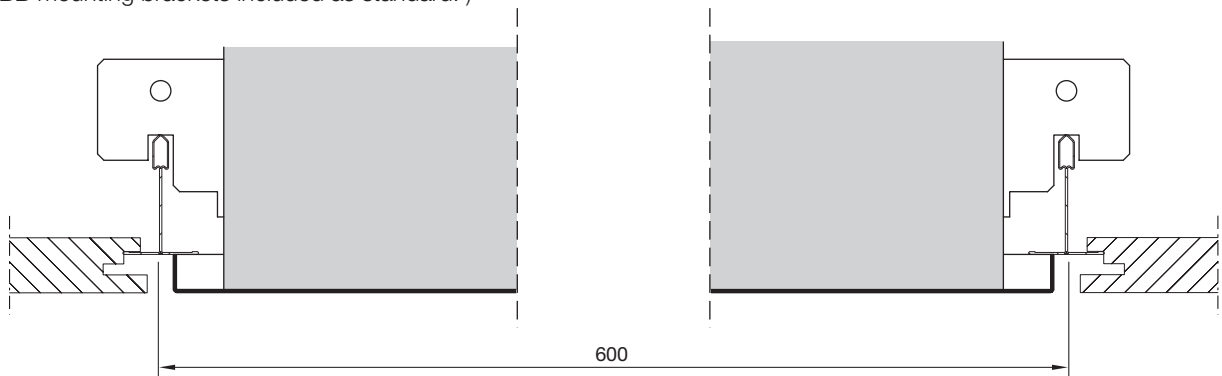

Sketch moduleplate type LM- Integra/Formo

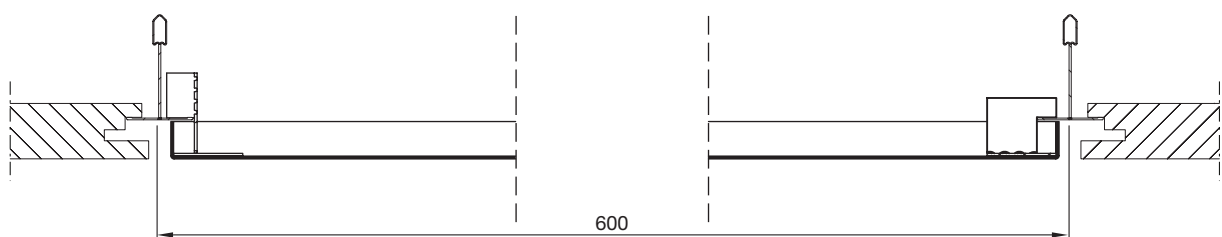

Ceiling tile adaption

9. Rockfon E10 24 Ecophon E / T24

Lindab's diffuser adapted to the above mentioned ceiling system is mounted directly in the ceiling system, as depicted in the sketches.

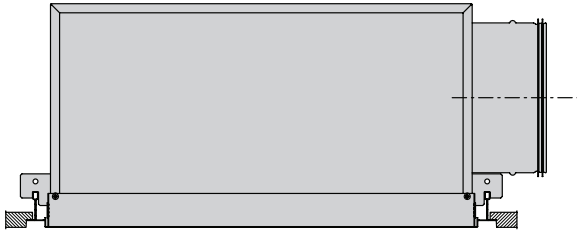

Plenum box type H including mounting bracket type PBB

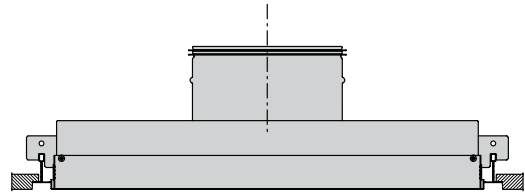

Grille box type V including mounting bracket type PBB

Sketch Versio- V, H, R pattern 300, 400, 500

(PBB mounting brackets not included, can be ordered separately.)

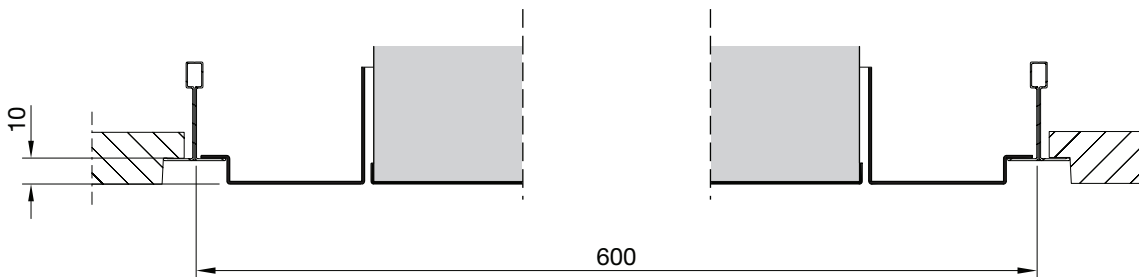

Sketch Versio- V, H, R pattern 600

(PBB mounting brackets included as standard.)

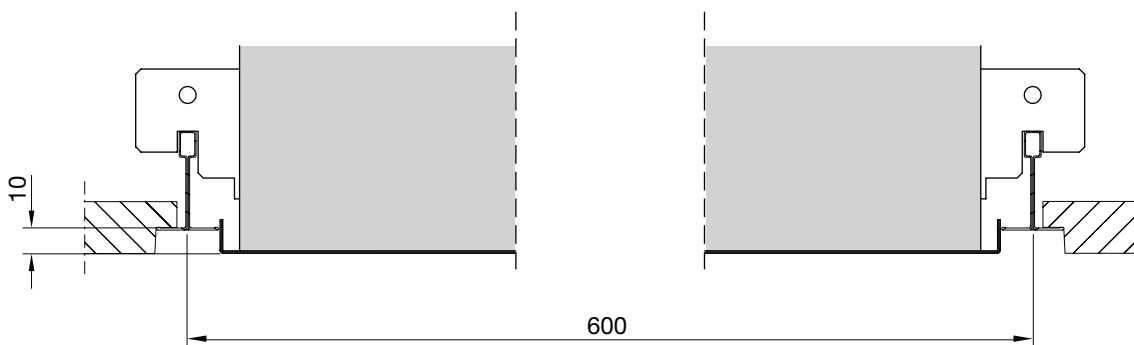

Sketch moduleplate type LM- Integra/Formo

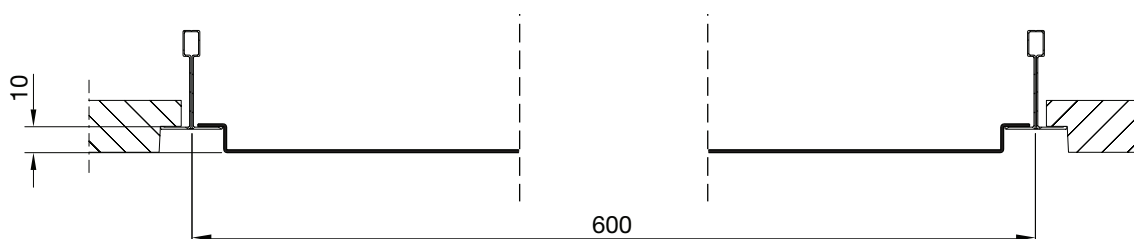

1
2
3
4
5
6
7
8
9
10
11
12
13
14
15
16
17
18

Ceiling tile adaption

10. Rockfon E10 15 Ecophon E / T15

Lindab's ceiling diffusers adapted to the above mentioned ceiling systems are mounted directly in the ceiling system, as depicted in the sketches.

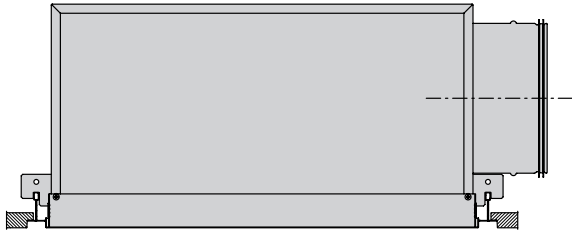

Plenum box type H including mounting bracket type PBB

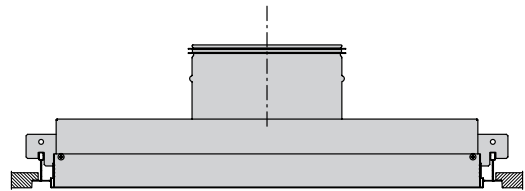

Grille box type V including mounting bracket type PBB

Sketch Versio- V, H, R pattern 300, 400, 500

(PBB mounting brackets not included, can be ordered separately.)

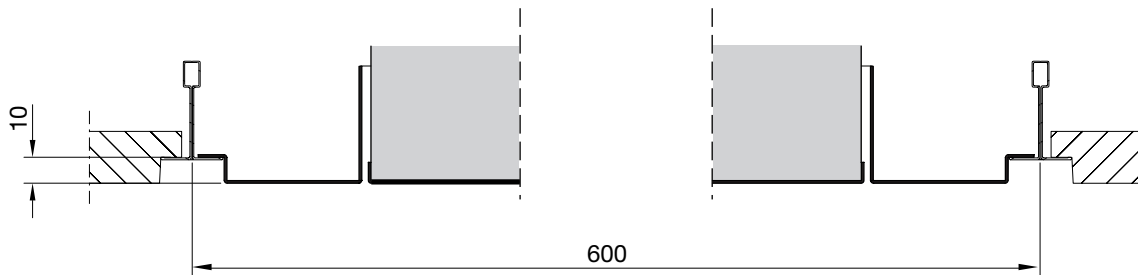

Sketch Versio- V, H, R pattern 600

(PBB mounting brackets included as standard.)

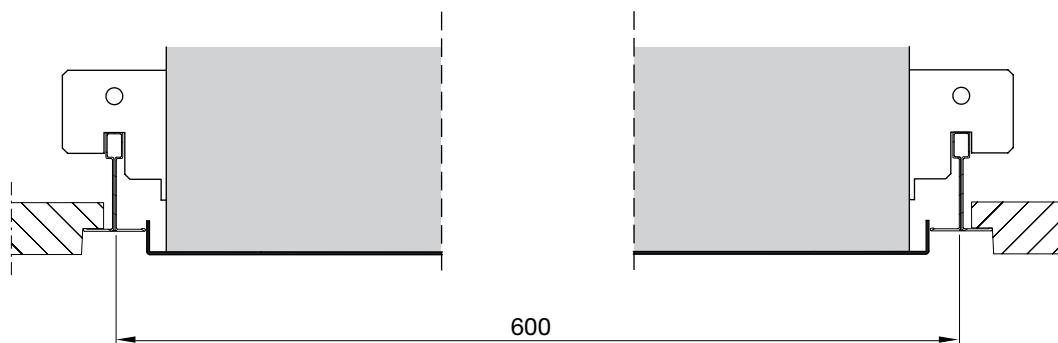

Sketch moduleplate type LM- Integra/Formo

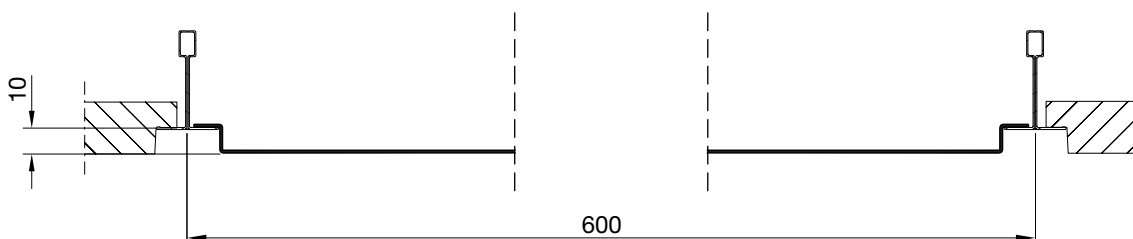

Ceiling tile adaption

11. Danotile Markant

Lindab's ceiling diffusers adapted to the above mentioned ceiling systems are mounted directly in the ceiling system, as depicted in the sketches.

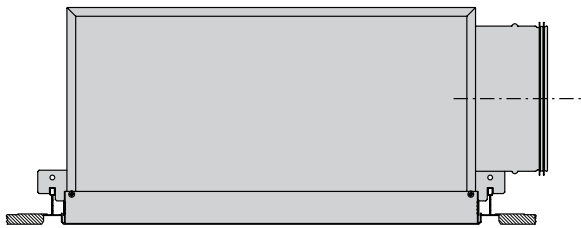

Plenum box type H including mounting bracket type PBB

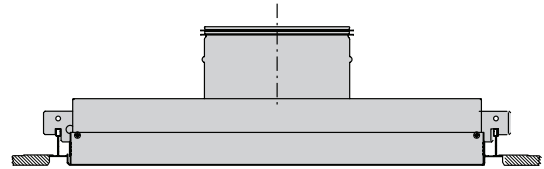

Grille box type V including mounting bracket type PBB

Sketch Versio- V, H, R pattern 300, 400, 500

(PBB mounting brackets not included, can be ordered separately.)

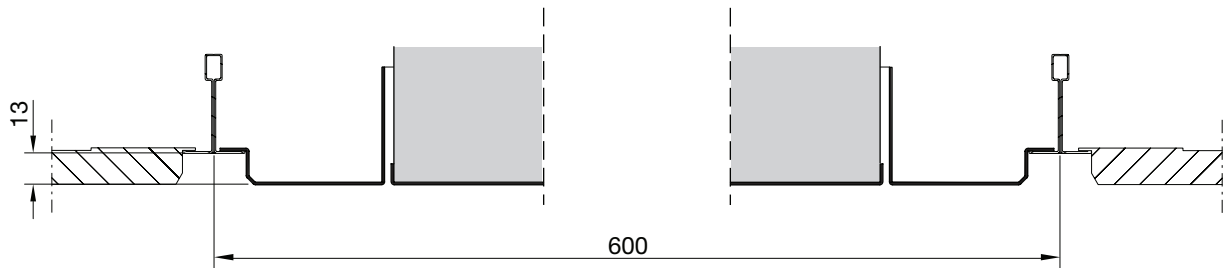

Sketch Versio- V, H, R pattern 600

(PBB mounting brackets included as standard.)

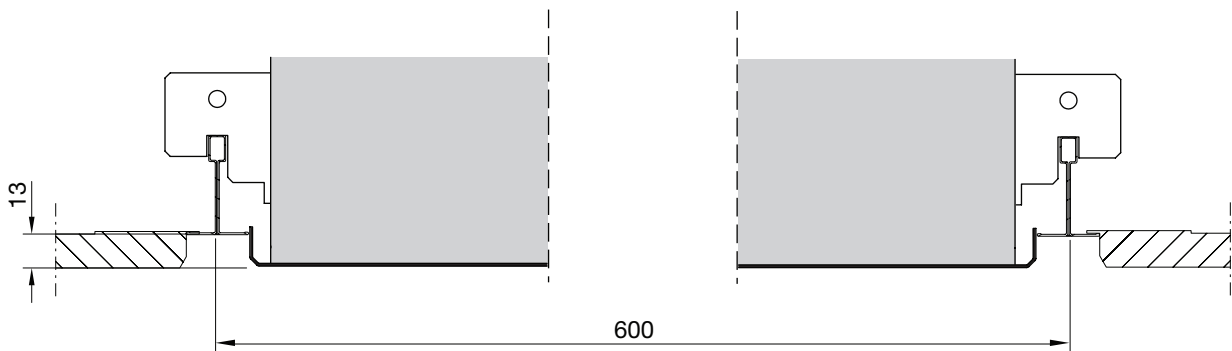

Sketch moduleplate type LM- Integra/Formo

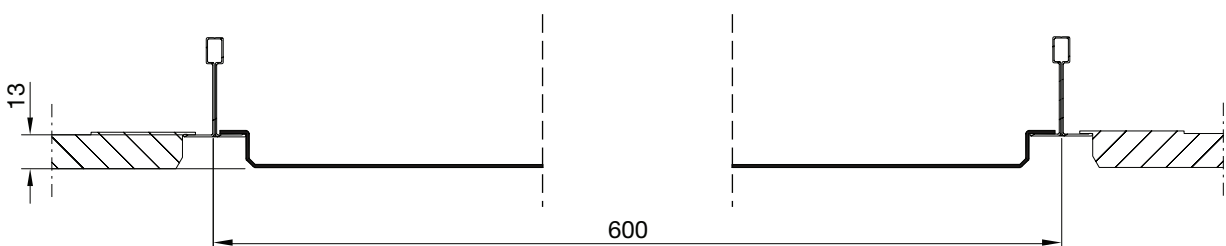

- 1
- 2
- 3
- 4
- 5
- 6
- 7
- 8
- 9
- 10
- 11
- 12
- 13
- 14
- 15
- 16
- 17
- 18

Ceiling tile adaption

14. Ecophon Focus edge DS

Lindab's diffuser adapted to Ecophon Focus edge DS ceiling systems, is mounted directly in the ceiling system, as depicted in the sketches.

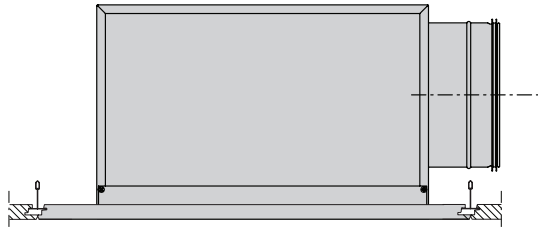

Plenum box type H

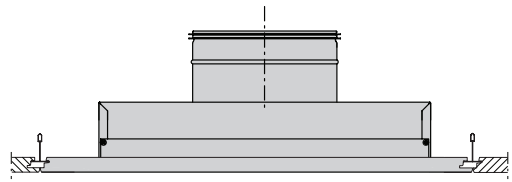

Grille box type V

Sketch Versio- V, H, R pattern 300, 400, 500

(PBB mounting brackets not included, can be ordered separately.)

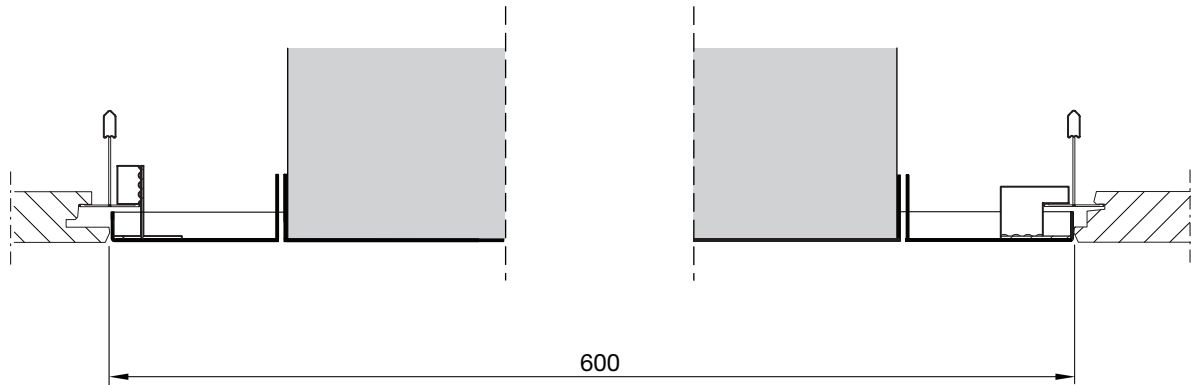

Sketch Versio- V, H, R pattern 600

(PBB mounting brackets included as standard.)

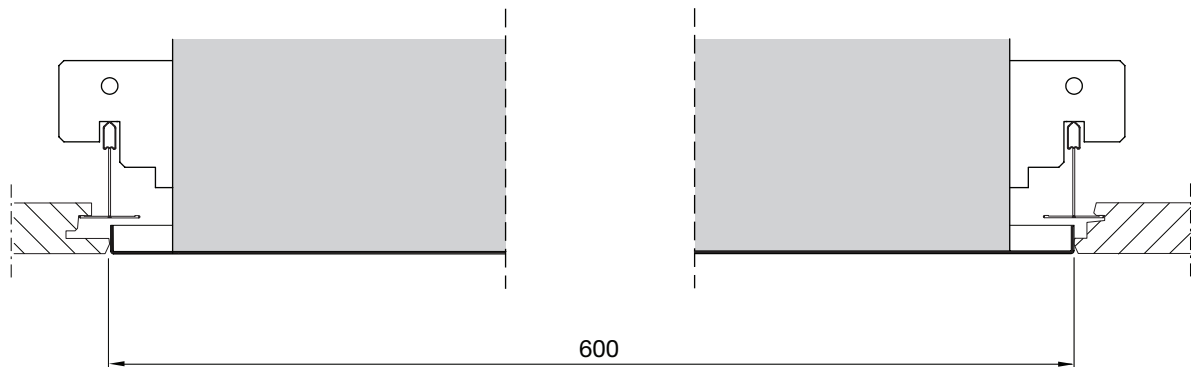

Sketch moduleplate type LM- Integra/Formo

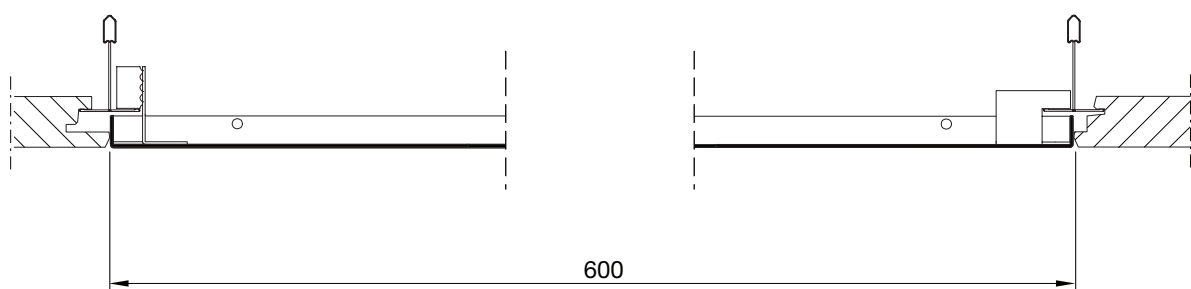

Ceiling tile adaption

Moduleplate

Ceiling tile adaption

Product



Diffuser size
Min. - max.

Ceiling types

Moduleplate type LM mm

PKA LKA PKV LKV		125 - 250
		125 - 250
		160 - 250
		160 - 250

Moduleplate type LM mm

PCA LCA CRL RCG PC6 PC7 RC14 RC15 NC19 PCV LCV		100 - 400
		100 - 400
		100 - 400
		125 - 315
		125 - 315
		160 - 315
		160 - 315
		160 - 315
		160 - 250
		160 - 250

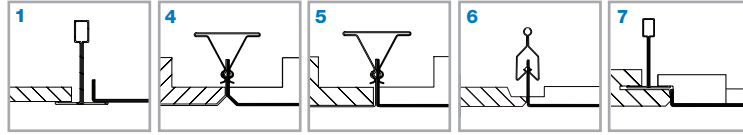

1 Danotile T24/T15 Ecophon T24 Rockfon A24.	4 Dampa Clip-In bevelled edge	5 Dampa Clip-In square edge	6 Luxalon SQ Clip-In	7 Danotile Contur Ecophon D Rockfon D-XL
--	-------------------------------------	-----------------------------------	----------------------------	---

F: 595 mm	F: 600 mm	F: 600 mm	F: 600 mm	F: 599 mm
-----------	-----------	-----------	-----------	-----------

●	●	●	●	●
●	●	●	●	●
●	●	●	●	●
●	●	●	●	●

F: 595 mm	F: 600 mm	F: 600 mm	F: 600 mm	F: 599 mm
-----------	-----------	-----------	-----------	-----------

●	●	●	●	●
●	●	●	●	●
●	●	●	●	●
●	●	●	●	●
●	●	●	●	●
●	●	●	●	●
●	●	●	●	●
●	●	●	●	●
●	●	●	●	●

● Combination possible

- 1
- 2
- 3
- 4
- 5
- 6
- 7
- 8
- 9
- 10
- 11
- 12
- 13
- 14
- 15
- 16
- 17
- 18

Ceiling tile adaption

Moduleplate

Ceiling tile adaption

Product



Diffuser size
Min. - max.

Ceiling types

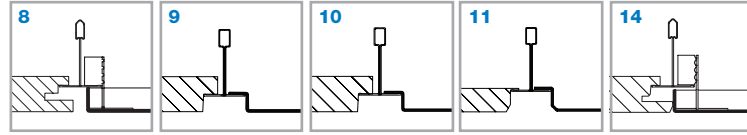

8 Ecophon Focus DG 9 Rockfon E10 24 Ecophon E / T24 10 Rockfon E10 15 Ecophon E / T15 11 Danotile Markant DG 14 Ecophon Focus edge DS

F: 595 mm F: 600 mm F: 600 mm F: 600 mm F: 599 mm

PKA LKA PKV LKV	Moduleplate type LM	mm
		125 - 250
		125 - 250
		160 - 250
		160 - 250

●	●	●	●	●
●	●	●	●	●
●	●	●	●	●
●	●	●	●	●

PCA LCA CRL RCG PC6 PC7 RC14 RC15 NC19 PCV LCV	Moduleplate type LM	mm
		100 - 400
		100 - 400
		100 - 400
		125 - 315
		125 - 315
		160 - 315
		160 - 315
		160 - 315
		160 - 315
		160 - 250
		160 - 250
		160 - 250

●	●	●	●	●
●	●	●	●	●
●	●	●	●	●
●	●	●	●	●
●	●	●	●	●
●	●	●	●	●
●	●	●	●	●
●	●	●	●	●
●	●	●	●	●
●	●	●	●	●

● Combination possible