

# TEST REPORT

Report No.: BCTC2510889032E

---

Applicant: REOLINK INNOVATION LIMITED

---

Product Name: WiFi IP Camera

---

Test Model: Argus PT Ultra

---

Tested Date: 2025-10-30 to 2025-11-28

---

Issued Date: 2025-12-18

---

**Shenzhen BCTC Testing Co., Ltd.**



Product Name: WiFi IP Camera  
Trademark:   
Model/Type Reference: Argus PT Ultra  
Argus Series B440  
Prepared For: REOLINK INNOVATION LIMITED  
Address: FLAT/RM 705 7/F FA YUEN COMMERCIAL BUILDING 75-77 FA YUEN STREET MONG KOK KL HONG KONG  
Manufacturer: REOLINK INNOVATION LIMITED  
Address: FLAT/RM 705 7/F FA YUEN COMMERCIAL BUILDING 75-77 FA YUEN STREET MONG KOK KL HONG KONG  
Prepared By: Shenzhen BCTC Testing Co., Ltd.  
Address: 1-2/F., Building B, Pengzhou Industrial Park, No.158, Fuyuan 1st Road, Zhancheng, Fuhai Subdistrict, Bao'an District, Shenzhen, Guangdong, China  
Sample Received Date: 2025-10-30  
Sample Tested Date: 2025-10-30 to 2025-11-28  
Issue Date: 2025-12-18  
Report No.: BCTC2510889032E  
Test Standards: EN 55032:2015+A1:2020, EN 55035:2017+A11:2020  
EN IEC 61000-3-2:2019+A2:2024, EN 61000-3-3:2013+A2:2021  
Test Results: PASS

Tested by:

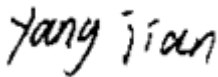

Yangjian/Project Handler

Approved by:



Zero Zhou/Reviewer

The test report is effective only with both signature and specialized stamp. This result(s) shown in this report refer only to the sample(s) tested. Without written approval of Shenzhen BCTC Testing Co., Ltd, this report can't be reproduced except in full. The tested sample(s) and the sample information are provided by the client.

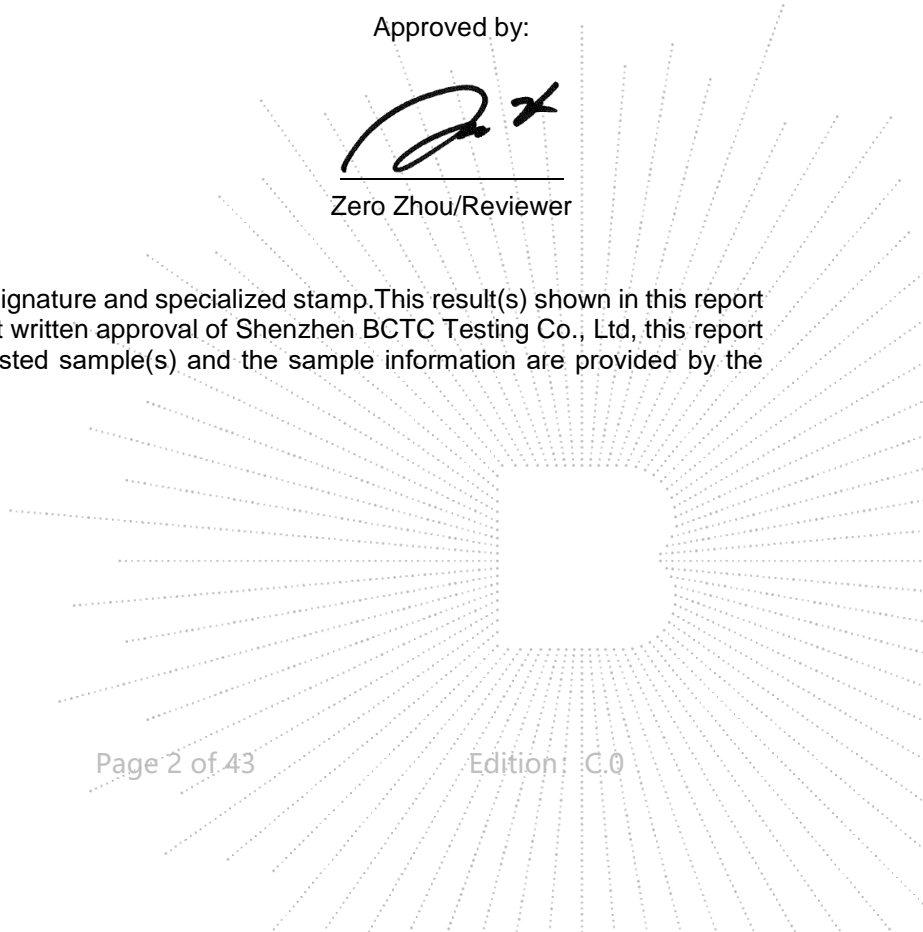

## Table Of Content

Test Report Declaration	Page
1. Version .....	5
2. Test Summary .....	6
3. Measurement Uncertainty .....	7
4. Product Information And Test Setup .....	8
4.1 Product Information .....	8
4.2 Test Setup Configuration .....	8
4.3 Support Equipment .....	8
4.4 Test Mode .....	9
5. Test Facility And Test Instrument Used .....	10
5.1 Test Facility .....	10
5.2 Test Instrument Used .....	10
6. Conducted Emissions .....	12
6.1 Block Diagram Of Test Setup .....	12
6.2 Limit .....	12
6.3 Test procedure .....	12
6.4 Test Result .....	13
7. Radiated Emissions Test .....	15
7.1 Block Diagram Of Test Setup .....	15
7.2 Limits .....	15
7.3 Test Procedure .....	16
7.4 Test Results .....	17
8. Voltage Fluctuations & Flicker(F) .....	21
8.1 Block Diagram of Test Setup .....	21
8.2 Limit .....	21
8.3 Test Procedure .....	21
8.4 Test Results .....	22
9. Immunity Test Of General The Performance Criteria .....	23
10. Electrostatic Discharge (ESD) .....	24
10.1 Test Specification .....	24
10.2 Block Diagram of Test Setup .....	24
10.3 Test Procedure .....	24
10.4 Test Results .....	25
11. Continuous RF Electromagnetic Field Disturbances (RS) .....	26
11.1 Test Specification .....	26
11.2 Block Diagram of Test Setup .....	26
11.3 Test Procedure .....	27
11.4 Test Results .....	27
12. Electrical Fast Transients/Burst (EFT) .....	28
12.1 Test Specification .....	28
12.2 Block Diagram of EUT Test Setup .....	28
12.3 Test Procedure .....	28
12.4 Test Results .....	28
13. Surges Immunity Test .....	29
13.1 Test Specification .....	29
13.2 Block Diagram of EUT Test Setup .....	29
13.3 Test Procedure .....	29

BCTC  
 PPR  
 Report

13.4	Test Result.....	29
14.	Continuous Induced RF Disturbances (CS) .....	30
14.1	Test Specification.....	30
14.2	Block Diagram of EUT Test Setup .....	30
14.3	Test Procedure .....	30
14.4	Test Result.....	30
15.	Voltage Dips And Interruptions (DIPS) .....	31
15.1	Test Specification.....	31
15.2	Block Diagram of EUT Test Setup .....	31
15.3	Test Procedure .....	31
15.4	Test Result.....	31
16.	EUT Photographs.....	32
17.	EUT Test Setup Photographs.....	39

(Note: N/A Means Not Applicable)

TEC  
TC  
OVB  
t See

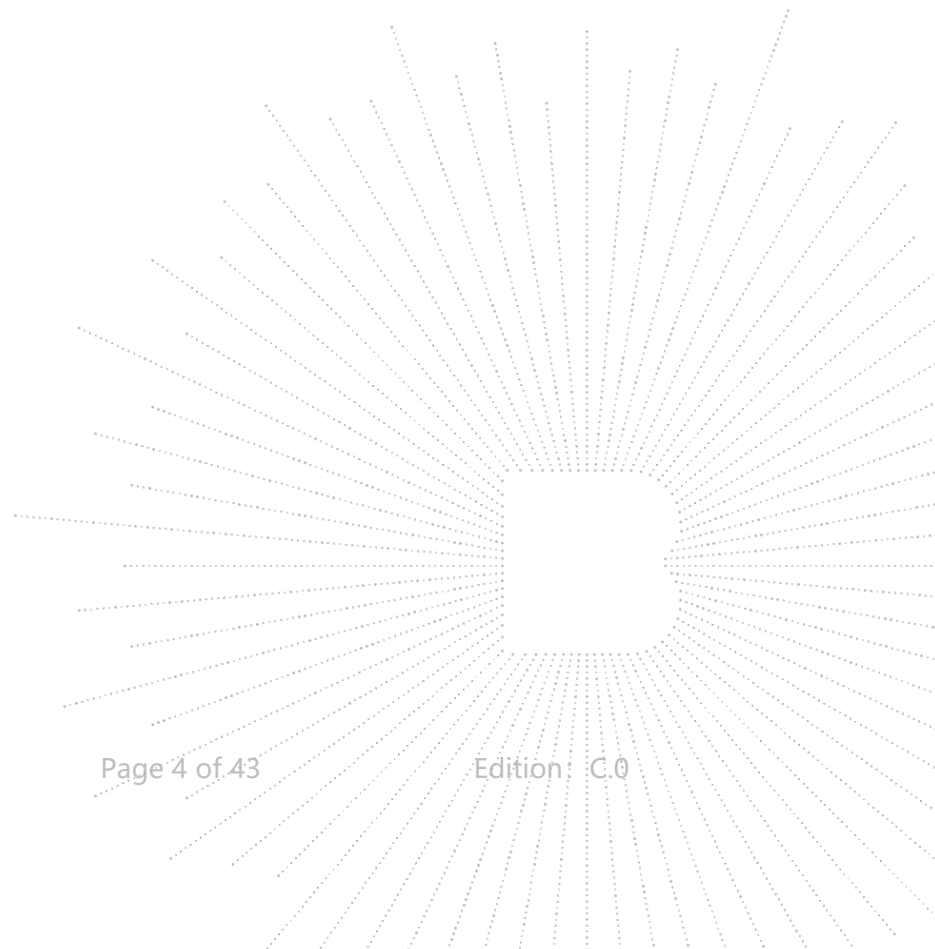

**1. Version**

<b>Report No.</b>	<b>Issue Date</b>	<b>Description</b>	<b>Approved</b>
BCTC2510889032E	2025-12-18	Original	Valid

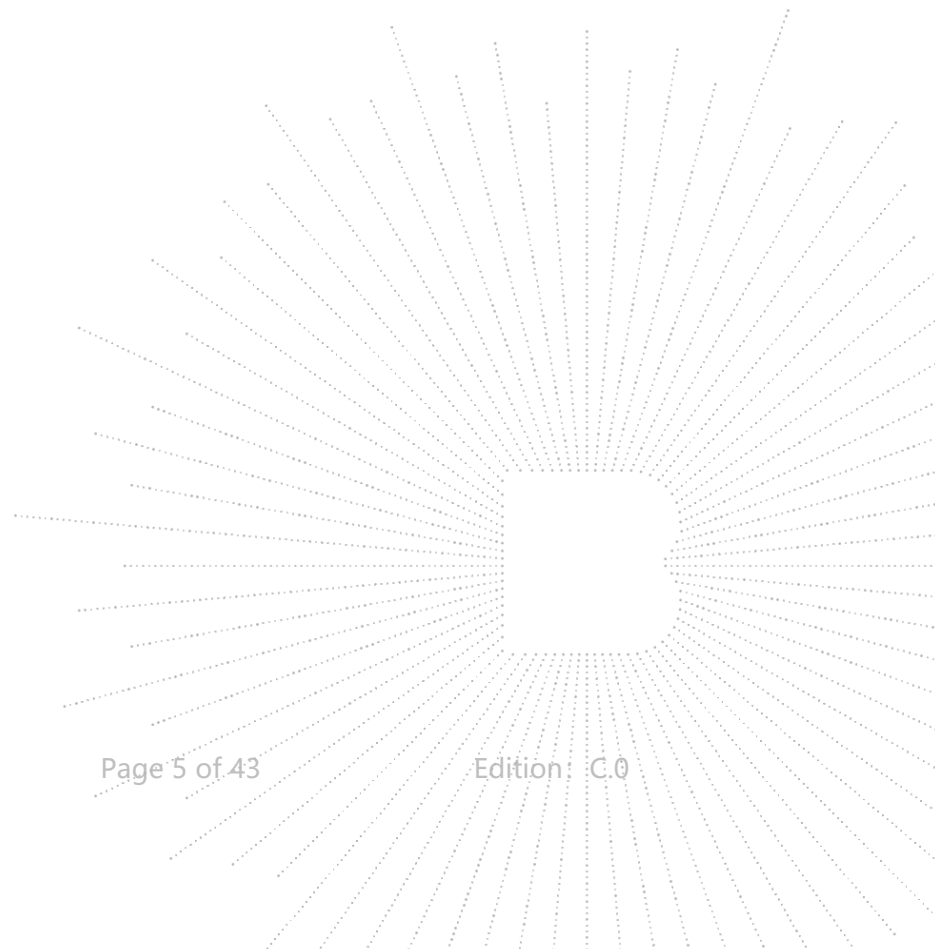

## 2. Test Summary

The Product has been tested according to the following specifications:

Emission		
Standard	Test Item	Test result
EN 55032	Conducted emissions from the AC mains power ports	Pass
EN 55032	Asymmetric mode conducted emissions	N/A <sup>5</sup>
EN 55032	Conducted differential voltage emissions	N/A <sup>1</sup>
EN 55032	Radiated emissions	Pass
EN IEC 61000-3-2	Harmonic current emission(H)	N/A <sup>2</sup>
EN 61000-3-3	Voltage fluctuations & flicker(F)	Pass

Immunity		
Standard	Test Item	Test result
EN 55035	Electrostatic discharge (ESD)	Pass
EN 55035	Continuous RF electromagnetic field disturbances(RS)	Pass
EN 55035	Electrical fast transients/burst (EFT)	Pass
EN 55035	Surges	Pass
EN 55035	Continuous induced RF disturbances (CS)	Pass
EN 55035	Broadband impulse noise disturbances, repetitive	N/A <sup>3</sup>
EN 55035	Broadband impulse noise disturbances, isolated	N/A <sup>3</sup>
EN 55035	Power frequency magnetic field (PFfull loadF)	N/A <sup>4</sup>
EN 55035	Voltage dips and interruptions (DIPS)	Pass

Remark:

- (1) TV broadcast receiver tuner ports with an accessible connector,  
(2) RF modulator output ports;  
(3) FM broadcast receiver tuner ports with an accessible connector.  
But the EUT has no above ports, so this test item is not applicable.
- The Product belongs to Class A, and its power is less than 75W, so it deems to fulfil this standard without testing.
- Applicable only to CPE xDSL ports.
- The Product doesn't contain any device susceptible to magnetic fields.
- Applicable to ports listed above and intended to connect to cables longer than 3 m.

### 3. Measurement Uncertainty

Where relevant, the following measurement uncertainty levels have been estimated for tests performed on the Product as specified in CISPR 16-4-2. This uncertainty represents an expanded uncertainty expressed at approximately the 95% confidence level using a coverage factor of  $k=2$ .

Test item	Value (dB)
Conducted Emission (150kHz-30MHz)	3.1
Radiated Emission(30MHz~200MHz)	4.5(SAC)
Radiated Emission(200MHz~1000MHz)	5.0(SAC)
Radiated Emission(1GHz~6GHz)	5.2(FAR)

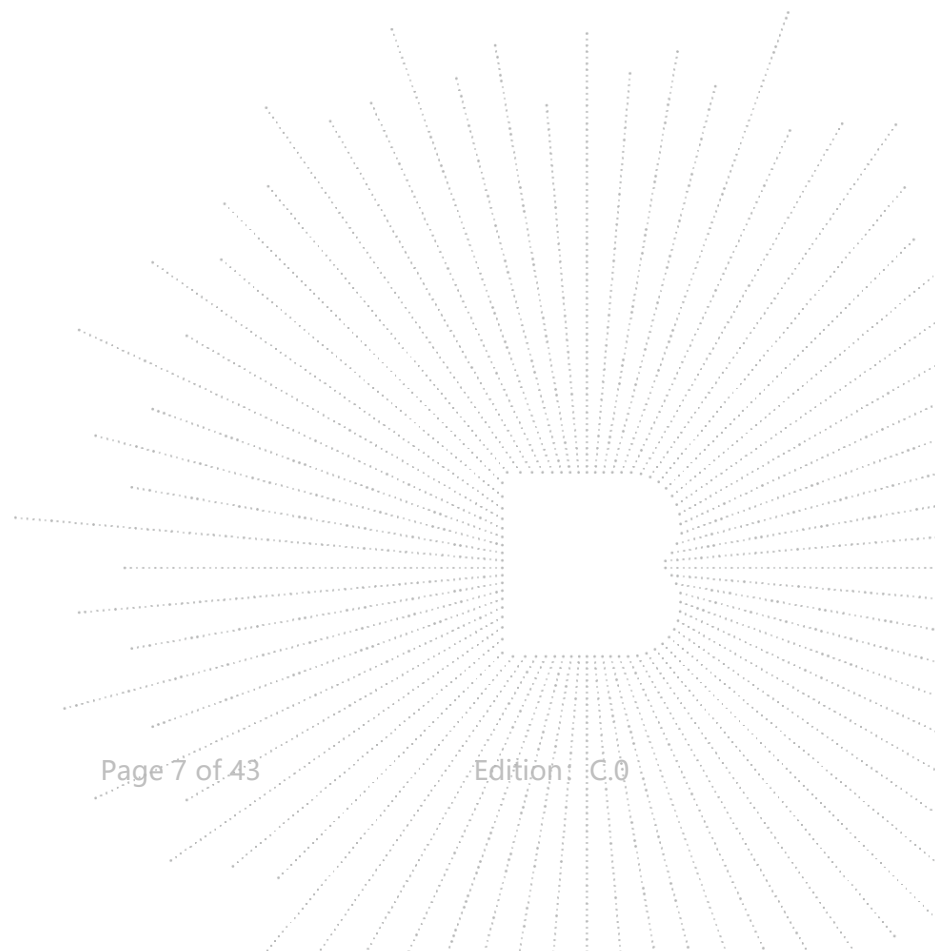

## 4. Product Information And Test Setup

### 4.1 Product Information

- Ratings:** DC 5V From Adapter  
DC 3.6V From Battery
- Model differences:** All models are identical except for the model names, the test model is Argus PT Ultra.
- The highest frequency of the internal sources of the EUT is (1066.5MHz):**
- less than 108 MHz, the measurement shall only be made up to 1 GHz.
  - between 108 MHz and 500 MHz, the measurement shall only be made up to 2 GHz.
  - between 500 MHz and 1 GHz, the measurement shall only be made up to 5 GHz.
  - above 1 GHz, the measurement shall be made up to 5 times the highest frequency or 6 GHz, whichever is less.

### 4.2 Test Setup Configuration

See test photographs attached in EUT TEST SETUP PHOTOGRAPHS for the actual connections between Product and support equipment.

### 4.3 Support Equipment

No.	Device Type	Brand	Model	Series No.	Note
1.	PC	Lenovo	ThinkPad E15 Gen4	---	---
2.	Adapter	UGREEN	CD289	---	---

**Notes:**

1. All the equipment/cables were placed in the worst-case configuration to maximize the emission during the test.
2. Grounding was established in accordance with the manufacturer's requirements and conditions for the intended use.



## 4.4 Test Mode

Test item	Test Mode	Test Voltage
Conducted emissions from the AC mains power ports (150KHz-30MHz) Class B	Charging+Working	DC 5V From Adapter Input AC 230V/50Hz
Radiated emissions(30MHz-1GHz) Class B	Charging+Working*	DC 5V From Adapter Input AC 230V/50Hz
	Working	DC 3.6V
Radiated emissions(1GHz -6GHz) Class B	Charging+Working*	DC 5V From Adapter Input AC 230V/50Hz
	Working	DC 3.6V
Voltage fluctuations & flicker(F)	Charging+Working	DC 5V From Adapter Input AC 230V/50Hz
Electrostatic discharge (ESD) <input checked="" type="checkbox"/> Air Discharge: ±8kV <input checked="" type="checkbox"/> Contact Discharge: ±4kV <input checked="" type="checkbox"/> HCP & VCP: ±4kV	Charging+Working	DC 5V From Adapter Input AC 230V/50Hz
	Working	DC 3.6V
Continuous RF electromagnetic field disturbances(RS) 80MHz-1000MHz, 1800MHz, 2600MHz,3500MHz,5000MHz 3V/m,80% AM Front, Rear, Left, Right H/V	Charging+Working	DC 5V From Adapter Input AC 230V/50Hz
	Working	DC 3.6V
Electrical fast transients/burst (EFT) <input checked="" type="checkbox"/> 1kV AC(Input) <input type="checkbox"/> 0.5kV DC(Input) <input type="checkbox"/> 0.5kV signal,Telec,control	Charging+Working	DC 5V From Adapter Input AC 230V/50Hz
Surges <input checked="" type="checkbox"/> 1kV Line-Line, <input type="checkbox"/> 2kV Line-PE, N-PE <input type="checkbox"/> 0.5kVDC(Input) <input type="checkbox"/> 1KV, <input type="checkbox"/> 4KV signal,Telec, control Line-Line:90°+1kV,270°-1kV Line-PE:90°+2kV,270°-2kV N-PE:90°-2kV,270°+2kV	Charging+Working	DC 5V From Adapter Input AC 230V/50Hz
Continuous induced RF disturbances (CS) 0.15MHz to 10MHz 3V,10MHz-30MHz 3 to 1V, 30MHz-80MHz 1V <input checked="" type="checkbox"/> AC( Input) <input type="checkbox"/> DC(Input) <input type="checkbox"/> signal,control	Charging+Working	DC 5V From Adapter Input AC 230V/50Hz
Voltage dips and interruptions (DIPS) Less 5% 0.5P 10ms     B 70% 25P 500ms        C Voltage Interruptions less5% 25P 5000ms    C	Charging+Working	DC 5V From Adapter Input AC 230V/50Hz
All test mode were tested and passed, only Radiated Emissions shows (*) is the worst case mode which were recorded in this report.		

## 5. Test Facility And Test Instrument Used

### 5.1 Test Facility

All measurement facilities used to collect the measurement data are located at Shenzhen BCTC Testing Co., Ltd. Address:1-2/F., Building B, Pengzhou Industrial Park, No.158, Fuyuan 1st Road, Zhancheng, Fuhai Subdistrict, Bao'an District, Shenzhen, Guangdong, China. The site and apparatus are constructed in conformance with the requirements of ANSI C63.4 and CISPR 16-1-1 other equivalent standards.

### 5.2 Test Instrument Used

Conducted Emissions Test					
Equipment	Manufacturer	Model#	Serial#	Last Cal.	Next Cal.
Receiver	R&S	ESR3	102075	May 08, 2025	May 07, 2026
LISN	R&S	ENV216	101375	May 14, 2025	May 13, 2026
LISN	Schwarzbeck	NSLK8127	8127739	Sep. 16, 2025	Sep. 15, 2026
Software	Frad	EZ-EMC	EMC-CON 3A1.1	\	\
Pulse limiter	Schwarzbeck	VTSD 9561-F	01323	May 14, 2025	May 13, 2026

Radiated Emissions Test (966 Chamber#01)					
Equipment	Manufacturer	Model#	Serial#	Last Cal.	Next Cal.
966 chamber	ChengYu	966 Room	966	May 15, 2023	May 14, 2026
Receiver	R&S	ESR17	100010	Oct. 31, 2025	Oct. 30, 2026
Receiver	R&S	ESR3	102075	May 08, 2025	May 07, 2026
Amplifier	SKET	LAPA_01G1 8G-45dB	SK2021040901	May 14, 2025	May 13, 2026
Amplifier	Schwarzbeck	BBV9745	9745-0370	Oct. 31, 2025	Oct. 30, 2026
TRILOG Broadband Antenna	schwarzbeck	VULB9163	942	May 24, 2025	May 23, 2026
Horn Antenna	schwarzbeck	BBHA9120D	1541	May 24, 2025	May 23, 2026
Software	Frad	EZ-EMC	FA-03A2 RE	\	\

Radiated Emissions Test (966 Chamber#02)					
Equipment	Manufacturer	Model#	Serial#	Last Cal.	Next Cal.
966 chamber	SKET	966 Room	966	Oct. 31, 2024	Oct. 30, 2027
Receiver	R&S	ESR3	102075	May 08, 2025	May 07, 2026
Receiver	R&S	ESRP	101154	May 14, 2025	May 13, 2026
TRILOG Broadband Antenna	Schwarzbeck	VULB9168	01323	May 24, 2025	May 23, 2026
Amplifier	SKET	LNPA-30M01 G-30	SK2021082004	Oct. 31, 2025	Oct. 30, 2026
Software	SKET	EZ-EMC	EMEC-3A1+	\	\
Horn Antenna	schwarzbeck	BBHA9120D	1541	May 24, 2025	May 23, 2026
Amplifier	SKET	LAPA_01G1 8G-45dB	SK2021040901	May 14, 2025	May 13, 2026

Harmonic / Flicker Test					
Equipment	Manufacturer	Model#	Serial#	Last Cal.	Next Cal.
Harmonic & Flicker Tester	LAPLACE	AC2000A	439263	May 16, 2025	May 15, 2026
AC Power Supply	KIKUSUI	PCR4000M	UK001879	May 14, 2025	May 13, 2026
Software	HTEC	H/F	V1.5	\	\

Electrostatic Discharge Test					
Equipment	Manufacturer	Model#	Serial#	Last Cal.	Next Cal.
Electrostatic Discharge Simulator	3C TEST	EDS 30T	ES031000123059	Mar. 04, 2025	Mar. 03, 2026

Continuous RF Electromagnetic Field Disturbances Test					
Equipment	Manufacturer	Model#	Serial#	Last Cal.	Next Cal.
Power meter	Keysight	E4419	A00065	May 14, 2025	May 13, 2026
Power sensor	Keysight	E9300A	US39211659	May 14, 2025	May 13, 2026
Power sensor	Keysight	E9300A	US39211305	May 14, 2025	May 13, 2026
Amplifier	SKET	HAP_801000-250W	21201805013	May 14, 2025	May 13, 2026
Amplifier	SKET	HAP_0103-75W	21201805014	May 14, 2025	May 13, 2026
Amplifier	SKET	HAP_0306-50W	21201805015	May 14, 2025	May 13, 2026
Stacked double Log.-Per. Antenna	Schwarzbeck	STLP 9129	00077	\	\
Field Probe	Narda	EP-601	611WX80256	May 14, 2025	May 13, 2026
Signal Generator	Agilent	N5181A	MY50143748	May 14, 2025	May 13, 2026
Software	SKET	EMC-S	1.4.0.58	\	\

EFT And Surge And Voltage Dips And Interruptions Test					
Equipment	Manufacturer	Model#	Serial#	Last Cal.	Next Cal.
Compact Generator	TRANSIENT	TRA2000	646	May 14, 2025	May 13, 2026
Coupling Clamp	PARTNER	CN-EFT1000	CN-EFT1000-1624	May 14, 2025	May 13, 2026

Continuous Induced RF Disturbances Test					
Equipment	Manufacturer	Model#	Serial#	Last Cal.	Next Cal.
C/S Test System	SCHLODER	CDG-6000-75	126B1405/2016	May 14, 2025	May 13, 2026
Attenuator	SCHLODER	6DB DC-1G	HA1630	May 14, 2025	May 13, 2026
CDN	SCHLODER	CDN M2+M3	A2210389/2016	May 14, 2025	May 13, 2026
Injection Clamp	SCHLOBER	EMCL-20	132A1272/2016	May 14, 2025	May 13, 2026
Software	HUBERT	HUBERTEN 61000-4-6	1.4.1.0	\	\



## 6. Conducted Emissions

### 6.1 Block Diagram Of Test Setup

For mains ports:

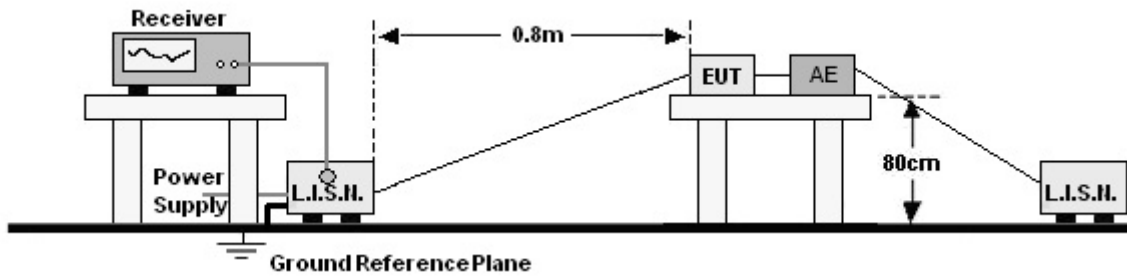

### 6.2 Limit

Limits for Conducted emissions at the mains ports of Class B MME

Frequency range (MHz)	Limits dB( $\mu$ V)	
	Quasi-peak	Average
0,15 to 0,50	66 to 56*	56 to 46*
0,50 to 5	56	46
5 to 30	60	50

Notes:

- \*Decreasing linearly with logarithm of frequency.
- The lower limit shall apply at the transition frequencies.

### 6.3 Test procedure

For mains ports:

- The Product was placed on a nonconductive table 0.8 m above the horizontal ground reference plane, and 0.4 m from the vertical ground reference plane, and connected to the main through Line Impedance Stability Network (L.I.S.N).
- The RBW of the receiver was set at 9 kHz in 150 kHz ~ 30MHz with Peak and AVG detector in Max Hold mode. Run the receiver's pre-scan to record the maximum disturbance generated from Product in all power lines in the full band.
- For each frequency whose maximum record was higher or close to limit, measure its QP and AVG values and record.

### 6.4 Test Result

Temperature:	26 °C	Relative Humidity:	54%RH
Pressure:	101kPa	Phase:	Line
Test Voltage :	DC 5V From Adapter Input AC 230V/50Hz	Test Mode:	Charging+Working

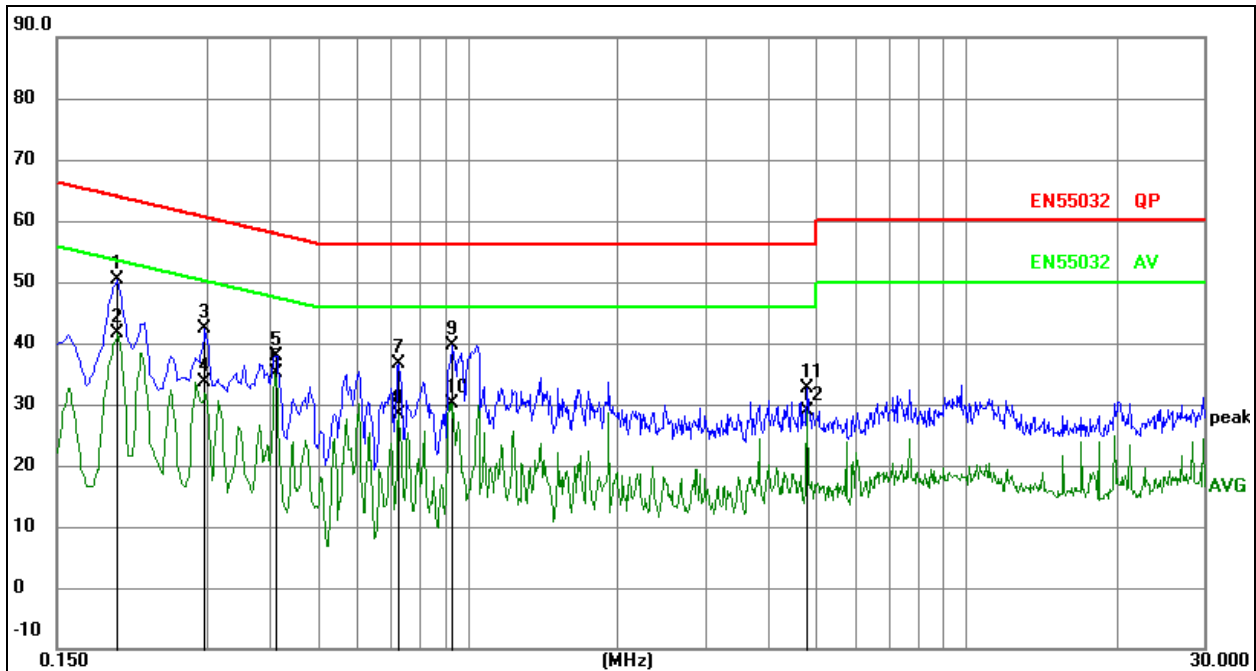

**Remark:**

1. All readings are Quasi-Peak and Average values.
2. Factor = Insertion Loss + Cable Loss.
3. Measurement = Reading Level + Correct Factor
4. Over = Measurement - Limit

No.	Mk.	Freq. MHz	Reading Level	Correct Factor dB	Measure- ment dBuV	Limit dBuV	Over dB	Detector
1		0.1986	30.45	20.04	50.49	63.67	-13.18	QP
2	*	0.1986	21.49	20.04	41.53	53.67	-12.14	AVG
3		0.2971	22.35	20.05	42.40	60.32	-17.92	QP
4		0.2971	13.65	20.05	33.70	50.32	-16.62	AVG
5		0.4105	17.91	20.05	37.96	57.64	-19.68	QP
6		0.4105	15.17	20.05	35.22	47.64	-12.42	AVG
7		0.7273	16.32	20.26	36.58	56.00	-19.42	QP
8		0.7273	8.11	20.26	28.37	46.00	-17.63	AVG
9		0.9331	19.44	20.27	39.71	56.00	-16.29	QP
10		0.9331	9.92	20.27	30.19	46.00	-15.81	AVG
11		4.7969	11.90	20.69	32.59	56.00	-23.41	QP
12		4.7969	8.09	20.69	28.78	46.00	-17.22	AVG

SHENZHEN

Temperature:	26 °C	Relative Humidity:	54%RH
Pressure:	101kPa	Phase:	Neutral
Test Voltage :	DC 5V From Adapter Input AC 230V/50Hz	Test Mode:	Charging+Working

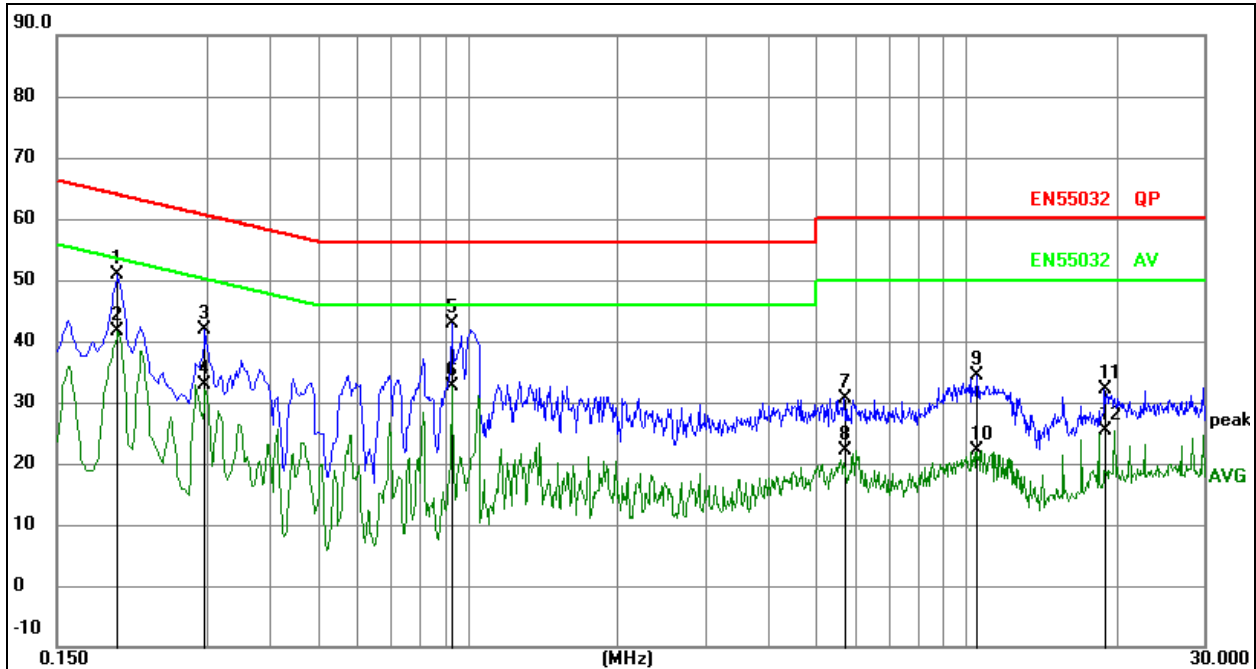
**Remark:**

1. All readings are Quasi-Peak and Average values.
2. Factor = Insertion Loss + Cable Loss.
3. Measurement = Reading Level + Correct Factor
4. Over = Measurement - Limit

No.	Mk.	Freq. MHz	Reading Level dB	Correct Factor dB	Measure- ment dBuV	Limit dBuV	Over dB	Detector
1		0.1986	30.81	20.04	50.85	63.67	-12.82	QP
2	*	0.1986	21.67	20.04	41.71	53.67	-11.96	AVG
3		0.2971	21.72	20.05	41.77	60.32	-18.55	QP
4		0.2971	12.72	20.05	32.77	50.32	-17.55	AVG
5		0.9282	22.61	20.27	42.88	56.00	-13.12	QP
6		0.9282	12.40	20.27	32.67	46.00	-13.33	AVG
7		5.6833	9.81	20.79	30.60	60.00	-29.40	QP
8		5.6833	1.22	20.79	22.01	50.00	-27.99	AVG
9		10.5079	12.87	21.46	34.33	60.00	-25.67	QP
10		10.5079	0.67	21.46	22.13	50.00	-27.87	AVG
11		18.9205	8.81	23.35	32.16	60.00	-27.84	QP
12		18.9205	1.99	23.35	25.34	50.00	-24.66	AVG

## 7. Radiated Emissions Test

### 7.1 Block Diagram Of Test Setup

30MHz ~ 1GHz:

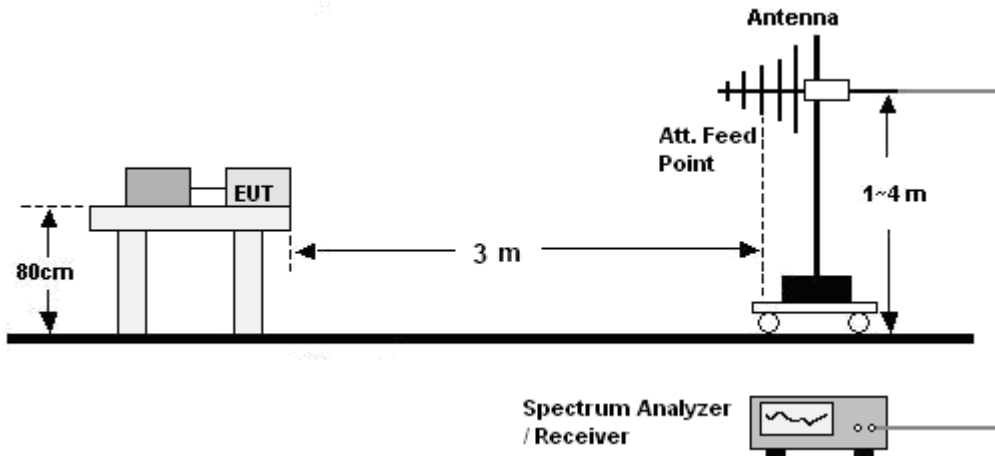

Above 1GHz:

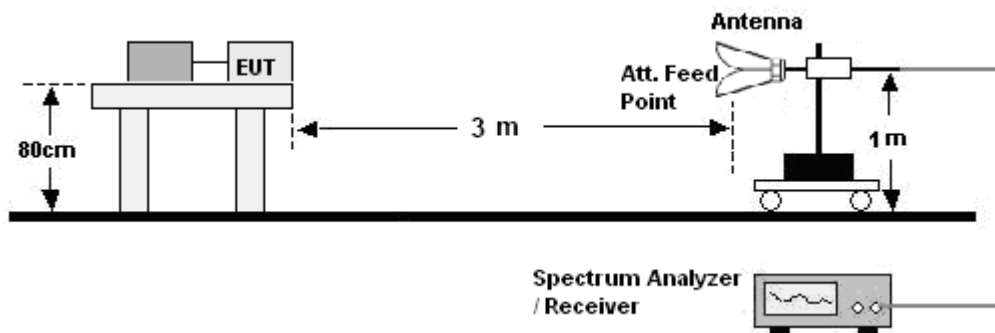

### 7.2 Limits

#### Limits for radiated disturbance of Class B MME

Frequency (MHz)	Quasi-peak limits at 3m dB(Mv/m)	
30-230	40	
230-1000	47	
Frequency (GHz)	limit above 1G at 3m dB(Mv/m)	
	Average	peak
1-3	50	70
3-6	54	74

**Note:** The lower limit shall apply at the transition frequencies.

### 7.3 Test Procedure

#### 30MHz ~ 1GHz:

- a. The Product was placed on the nonconductive turntable 0.8 m above the ground in a semi anechoic chamber.
- b. Set the spectrum analyzer/receiver in Peak detector, Max Hold mode, and 120 kHz RBW. Record the maximum field strength of all the pre-scan process in the full band when the antenna is varied between 1~4 m in both horizontal and vertical, and the turntable is rotated from 0 to 360 degrees.
- c. For each frequency whose maximum record was higher or close to limit, measure its QP value: vary the antenna's height and rotate the turntable from 0 to 360 degrees to find the height and degree where Product radiated the maximum emission, then set the test frequency analyzer/receiver to QP Detector and specified bandwidth with Maximum Hold Mode, and record the maximum value.

#### Above 1GHz:

- a. The Product was placed on the non-conductive turntable 0.8 m above the ground in a full anechoic chamber.
- b. Set the spectrum analyzer/receiver in Peak detector, Max Hold mode, and 1MHz RBW. Record the maximum field strength of all the pre-scan process in the full band when the antenna is varied in both horizontal and vertical, and the turntable is rotated from 0 to 360 degrees.
- c. For each frequency whose maximum record was higher or close to limit, measure its AV value: rotate the turntable from 0 to 360 degrees to find the degree where Product radiated the maximum emission, then set the test frequency analyzer/receiver to AV value and specified bandwidth with Maximum Hold Mode, and record the maximum value.

### 7.4 Test Results

30MHz ~ 1GHz:

Temperature:	26 °C	Relative Humidity:	54%RH
Pressure:	101KPa	Phase :	Horizontal
Test Voltage :	DC 5V From Adapter Input AC 230V/50Hz	Test Mode:	The worst data (Charging+Working)

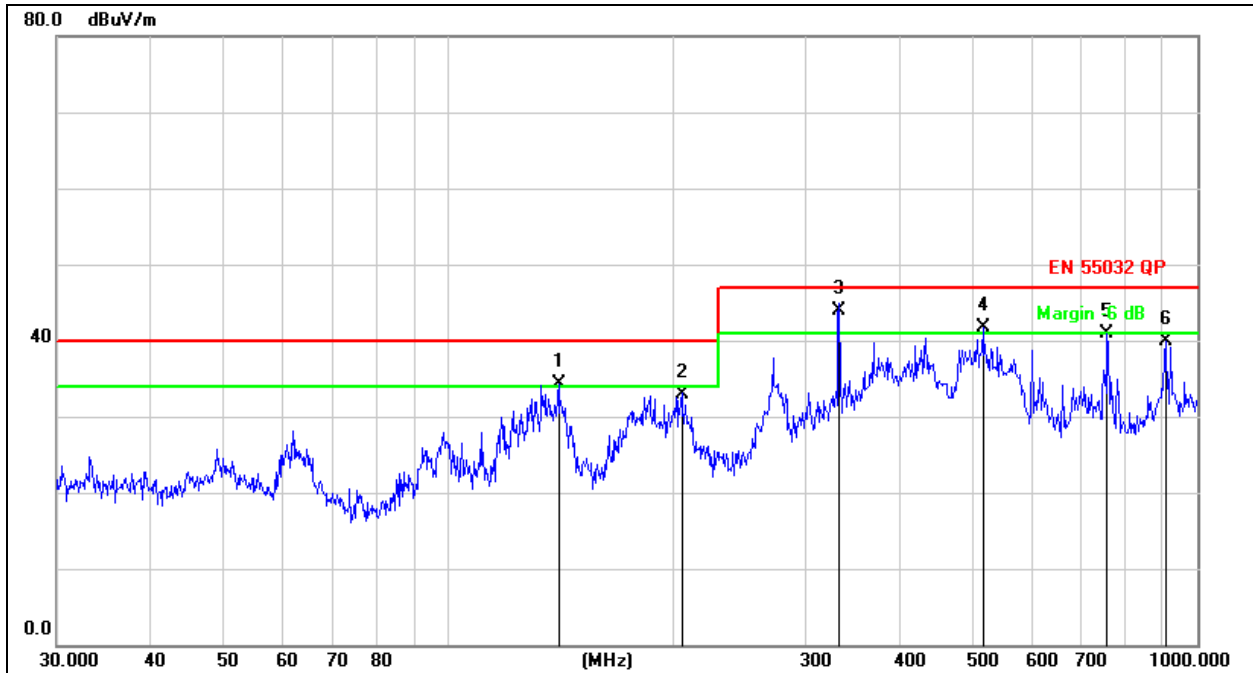

Remark:

1. Factor = Antenna Factor + Cable Loss – Pre-amplifier.
2. Measurement = Reading Level + Correct Factor
3. Over = Measurement - Limit

No.	Mk.	Freq.	Reading Level	Correct Factor	Measurement	Limit	Over	Detector
		MHz	dBuV	dB	dBuV/m	dB/m	dB	
1	!	140.3420	47.55	-13.21	34.34	40.00	-5.66	QP
2		204.9550	42.43	-9.43	33.00	40.00	-7.00	QP
3	*	331.6187	50.71	-6.77	43.94	47.00	-3.06	QP
4	!	517.2480	45.10	-3.31	41.79	47.00	-5.21	QP
5		758.0407	41.20	-0.35	40.85	47.00	-6.15	QP
6		906.4823	37.87	1.96	39.83	47.00	-7.17	QP

Temperature:	26 °C	Relative Humidity:	54%RH
Pressure:	101KPa	Phase :	Vertical
Test Voltage :	DC 5V From Adapter Input AC 230V/50Hz	Test Mode:	The worst data (Charging+Working)

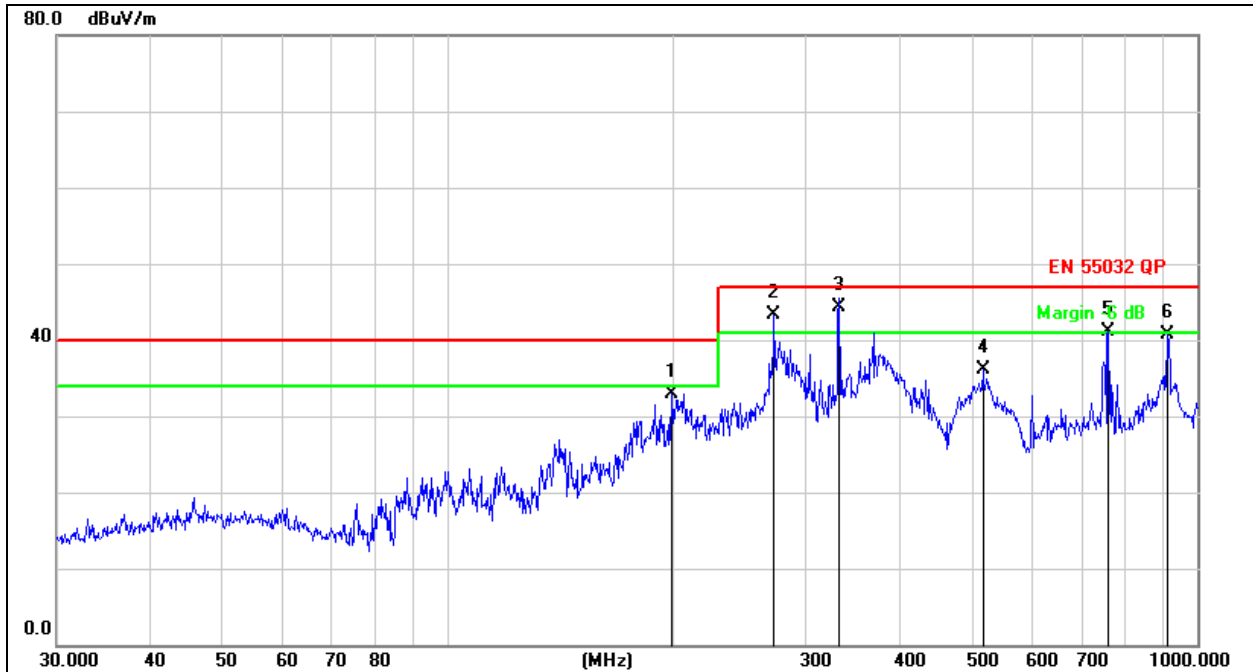

Remark:

- Factor = Antenna Factor + Cable Loss – Pre-amplifier.
- Measurement = Reading Level + Correct Factor
- Over = Measurement - Limit

No.	Mk.	Freq.	Reading Level	Correct Factor	Measurement	Limit	Over	Detector
		MHz	dBuV	dB	dBuV/m	dB/m	dB	
1		198.5880	42.49	-9.57	32.92	40.00	-7.08	QP
2	!	272.2776	51.42	-8.11	43.31	47.00	-3.69	QP
3	*	331.6986	50.99	-6.77	44.22	47.00	-2.78	QP
4		517.2480	39.47	-3.31	36.16	47.00	-10.84	QP
5	!	760.7036	41.41	-0.31	41.10	47.00	-5.90	QP
6		912.8620	38.77	1.98	40.75	47.00	-6.25	QP

Above 1GHz:

Temperature:	24.2 °C	Relative Humidity:	52%RH
Pressure:	101KPa	Phase :	Horizontal
Test Voltage :	DC 5V From Adapter Input AC 230V/50Hz	Test Mode:	The worst data (Charging+Working)

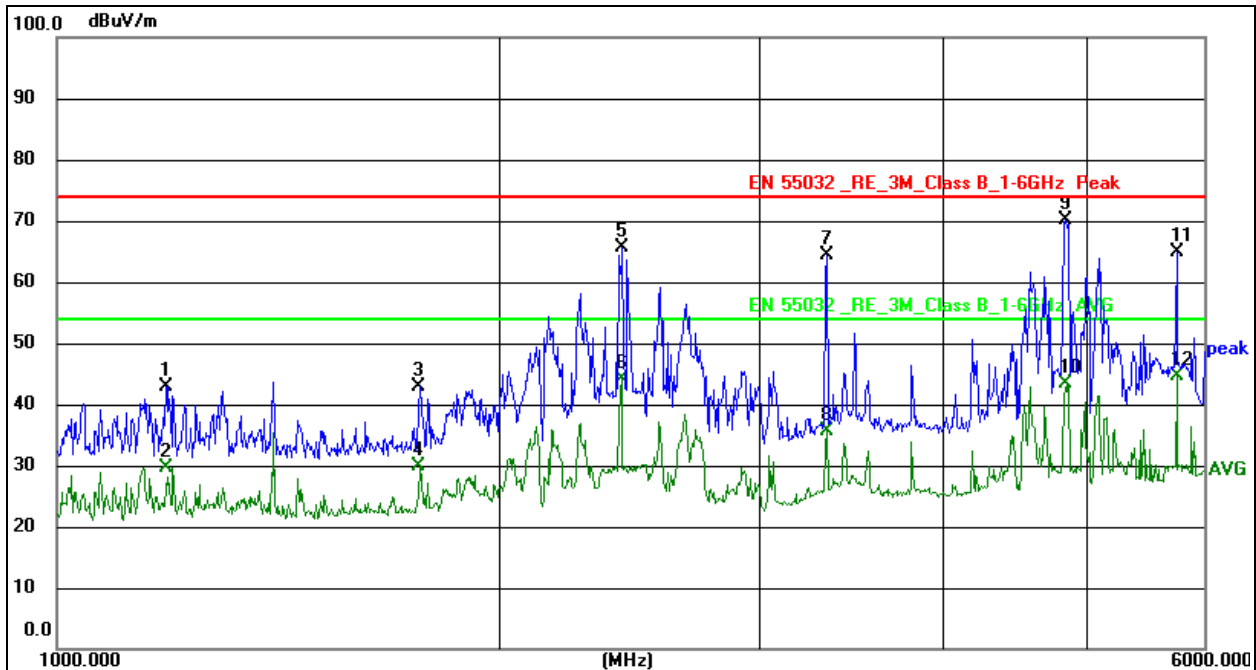

Remark:

- Factor = Antenna Factor + Cable Loss – Pre-amplifier.
- Measurement = Reading Level + Correct Factor
- Over = Measurement - Limit

No.	Frequency (MHz)	Reading (dBuV)	Factor (dB/m)	Level (dBuV/m)	Limit (dBuV/m)	Margin (dB)	Detector
1	1187.688	70.82	-27.92	42.90	74.00	-31.10	peak
2	1187.688	57.49	-27.92	29.57	54.00	-24.43	AVG
3	1761.553	69.75	-26.93	42.82	74.00	-31.18	peak
4	1761.553	56.89	-26.93	29.96	54.00	-24.04	AVG
5	2418.959	91.29	-25.76	65.53	74.00	-8.47	peak
6	2418.959	69.81	-25.76	44.05	54.00	-9.95	AVG
7	3327.664	88.49	-24.18	64.31	74.00	-9.69	peak
8	3327.664	59.91	-24.18	35.73	54.00	-18.27	AVG
9 *	4830.532	90.53	-20.34	70.19	74.00	-3.81	peak
10	4830.532	63.81	-20.34	43.47	54.00	-10.53	AVG
11	5747.456	82.92	-17.96	64.96	74.00	-9.04	peak
12	5747.456	62.59	-17.96	44.63	54.00	-9.37	AVG

SHENZHEN

Temperature:	24.2 °C	Relative Humidity:	52%RH
Pressure:	101KPa	Phase :	Vertical
Test Voltage :	DC 5V From Adapter Input AC 230V/50Hz	Test Mode:	The worst data (Charging+Working)

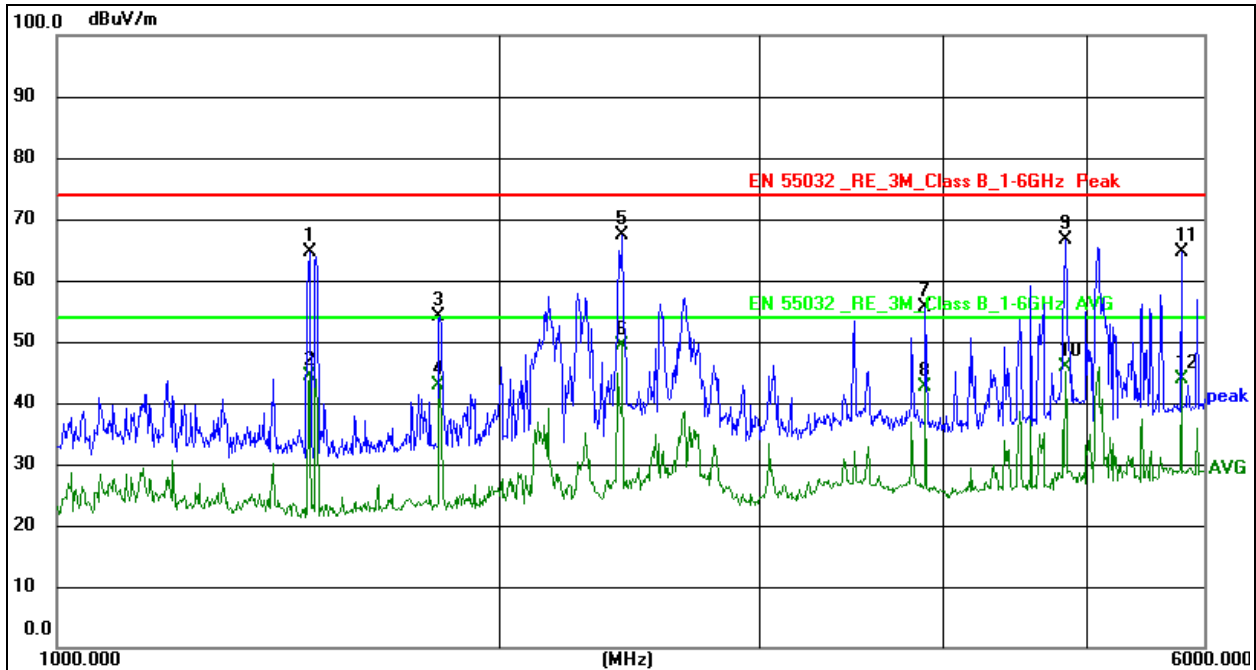

**Remark:**

- Factor = Antenna Factor + Cable Loss – Pre-amplifier.
- Measurement = Reading Level + Correct Factor
- Over = Measurement - Limit

No.	Frequency (MHz)	Reading (dBuV)	Factor (dB/m)	Level (dBuV/m)	Limit (dBuV/m)	Margin (dB)	Detector
1	1483.178	92.08	-27.33	64.75	74.00	-9.25	peak
2	1483.178	71.75	-27.33	44.42	54.00	-9.58	AVG
3	1819.292	81.04	-26.85	54.19	74.00	-19.81	peak
4	1819.292	69.76	-26.85	42.91	54.00	-11.09	AVG
5	2418.959	93.16	-25.76	67.40	74.00	-6.60	peak
6 *	2418.959	75.15	-25.76	49.39	54.00	-4.61	AVG
7	3882.044	78.63	-23.04	55.59	74.00	-18.41	peak
8	3882.044	65.76	-23.04	42.72	54.00	-11.28	AVG
9	4830.532	87.07	-20.34	66.73	74.00	-7.27	peak
10	4830.532	66.23	-20.34	45.89	54.00	-8.11	AVG
11	5788.796	82.36	-17.85	64.51	74.00	-9.49	peak
12	5788.796	61.73	-17.85	43.88	54.00	-10.12	AVG

## 8. Voltage Fluctuations & Flicker(F)

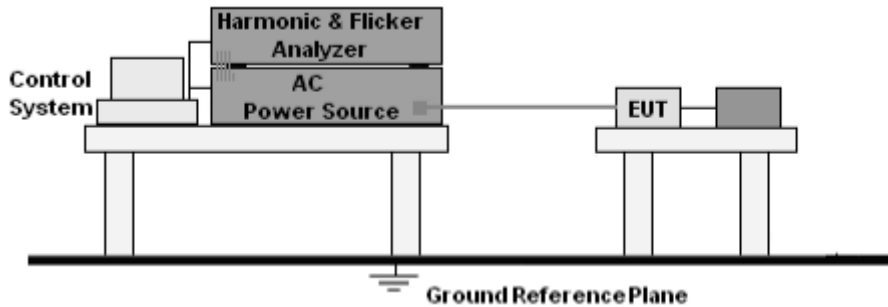
### 8.1 Block Diagram of Test Setup



### 8.2 Limit

EN 61000-3-3:2013+A2:2021 Clause 5.

### 8.3 Test Procedure

a. The Product was placed on the top of a non-conductive table above the ground and operated to produce the most unfavorable sequence of voltage changes under normal operating conditions.

b. During the flick test, the measure time shall include that part of whole operation cycle in which the Product produce the most unfavorable sequence of voltage changes. The observation period for short-term flicker indicator is 10 minutes and the observation period for long-term flicker indicator is 2 hours.

## 8.4 Test Results

Temperature:	24.5 °C	Relative Humidity:	54%RH
Pressure:	101KPa	Test Mode:	Charging+Working
Test Voltage :	DC 5V From Adapter Input AC 230V/50Hz		

<b>Test duration (sec):600</b>			
<b>Describe:Charging+Working</b>			
<b>Load Power</b>	<b>: 0.007 kW</b>	<b>Power Factor:0.538</b>	
<b>Load Current</b>	<b>: 0.051 Arms</b>	<b>Crest Factor:1.804</b>	
<b>Nominal Voltage</b>	<b>: 230.24 Vrms</b>		
<b>Test Result: pass</b>		<b>Status: Test Completed</b>	
<b>Result:</b>			
<b>T-max (ms):</b>	<b>0.00</b>	<b>Test limit (ms): 500.00</b>	<b>Pass</b>
<b>Highest dc (%):</b>	<b>0.04</b>	<b>Test limit (%): 3.30</b>	<b>Pass</b>
<b>Highest dmax (%):</b>	<b>0.60</b>	<b>Test limit (%): 4.00</b>	<b>Pass</b>
<b>Highest Pst (10 min. period):</b>	<b>0.02</b>	<b>Test limit: 1.00</b>	<b>Pass</b>

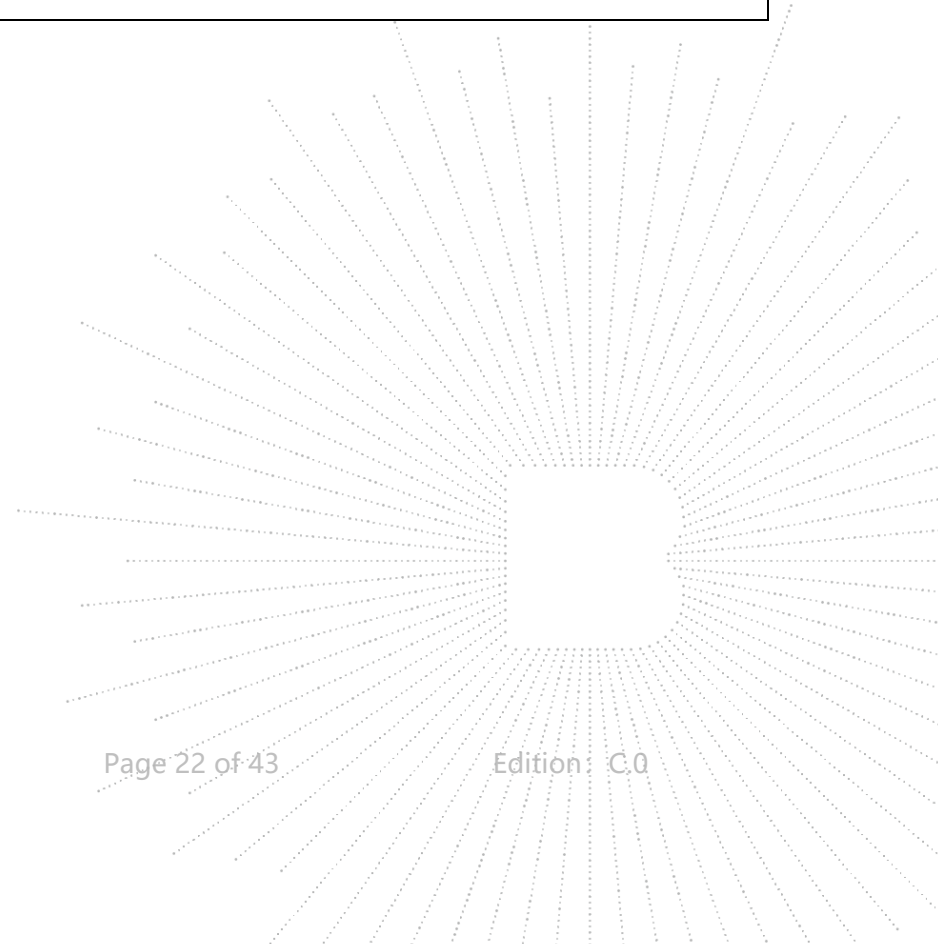

## 9. Immunity Test Of General The Performance Criteria

Product Standard	EN 55035:2017+A11:2020 clause 5
<b>CRITERION A</b>	<p>The equipment shall continue to operate as intended without operator intervention. No degradation of performance, loss of function or change of operating state is allowed below a performance level specified by the manufacturer when the equipment is used as intended. The performance level may be replaced by a permissible loss of performance. If the minimum performance level or the permissible performance loss is not specified by the manufacturer, then either of these may be derived from the product description and documentation, and by what the user may reasonably expect from the equipment if used as intended.</p>
<b>CRITERION B</b>	<p>During the application of the disturbance, degradation of performance is allowed. However, no unintended change of actual operating state or stored data is allowed to persist after the test.</p> <p>After the test, the equipment shall continue to operate as intended without operator intervention; no degradation of performance or loss of function is allowed, below a performance level specified by the manufacturer, when the equipment is used as intended. The performance level may be replaced by a permissible loss of performance.</p> <p>If the minimum performance level (or the permissible performance loss), or recovery time, is not specified by the manufacturer, then either of these may be derived from the product description and documentation, and by what the user may reasonably expect from the equipment if used as intended.</p>
<b>CRITERION C</b>	<p>Loss of function is allowed, provided the function is self-recoverable, or can be restored by the operation of the controls by the user in accordance with the manufacturer's instructions. A reboot or re-start operation is allowed.</p> <p>Information stored in non-volatile memory, or protected by a battery backup, shall not be lost.</p>

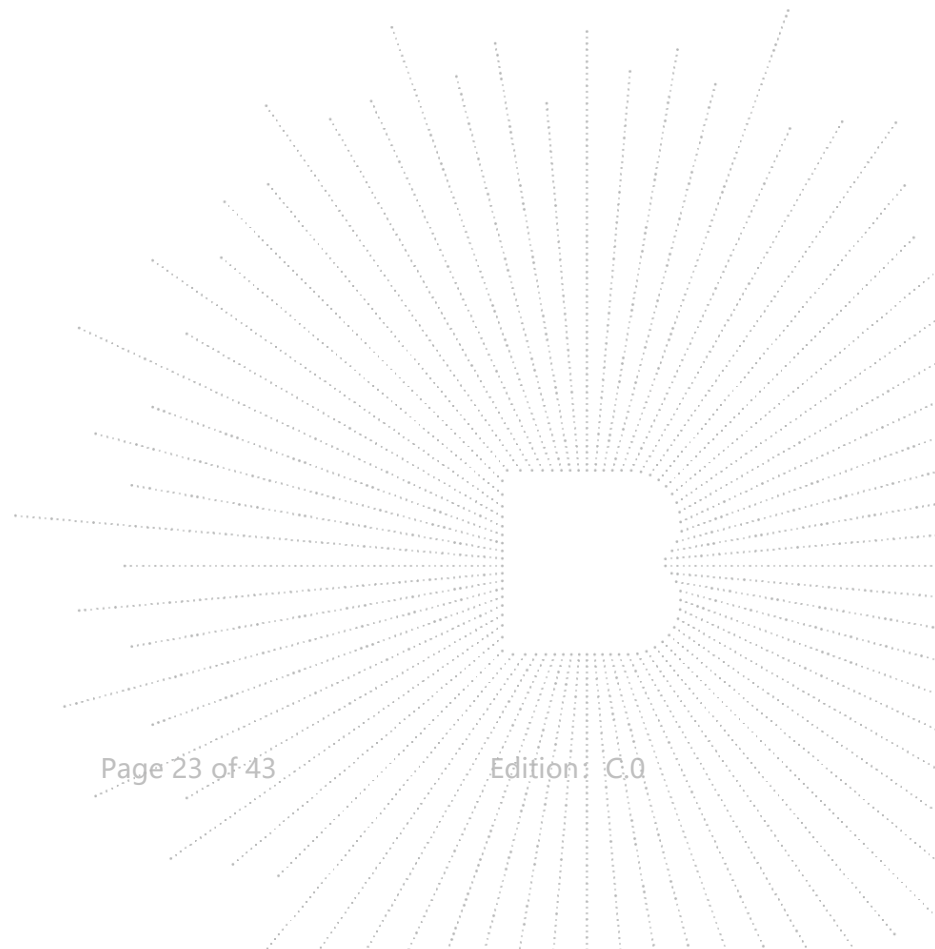

## 10. Electrostatic Discharge (ESD)

### 10.1 Test Specification

<b>Basic standard</b>	: IEC 61000-4-2
<b>Test Port</b>	: Enclosure port
<b>Discharge Impedance</b>	: 330 ohm / 150 pF
<b>Discharge Mode</b>	: Single Discharge
<b>Discharge Period</b>	: one second between each discharge

### 10.2 Block Diagram of Test Setup

For Floor Stand:

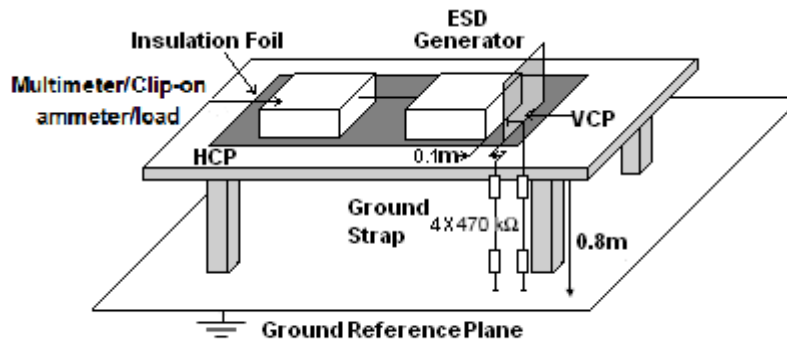

### 10.3 Test Procedure

- Electrostatic discharges were applied only to those points and surfaces of the Product that are accessible to users during normal operation.
- The test was performed with at least ten single discharges on the pre-selected points in the most sensitive polarity.
- The time interval between two successive single discharges was at least 1 second.
- The ESD generator was held perpendicularly to the surface to which the discharge was applied and the return cable was at least 0.2 meters from the Product.
- Contact discharges were applied to the non-insulating coating, with the pointed tip of the generator penetrating the coating and contacting the conducting substrate.
- Air discharges were applied with the round discharge tip of the discharge electrode approaching the Product as fast as possible (without causing mechanical damage) to touch the Product. After each discharge, the ESD generator was removed from the Product and re-triggered for a new single discharge. The test was repeated until all discharges were complete.
- At least ten single discharges (in the most sensitive polarity) were applied to the center of one vertical edge of the Vertical Coupling Plane in sufficiently different positions that the four faces of the Product were completely illuminated. The VCP (dimensions 0.5m x 0.5m) was placed vertically to and 0.1 meters from the Product.

## 10.4 Test Results

Temperature:	24.8 °C	Relative Humidity:	50%RH
Pressure:	101KPa	Test Mode:	Charging+Working/ Working
Test Voltage :	DC 5V From Adapter Input AC 230V/50Hz /DC 3.6V		

Discharge Method	Discharge Position	Voltage (±kV)	Min. No. of Discharge per polarity (Each Point)	Required Level	Performance Criterion
Contact Discharge	Indirect Discharge HCP	4	10	B	A
	Indirect Discharge VCP	4	10	B	A
Air Discharge	Shell Gap, lamp, camera	8	10	B	B

Note\*:  
 B: The EUT Unable to working during testing, and it end of the test can be restored automatically

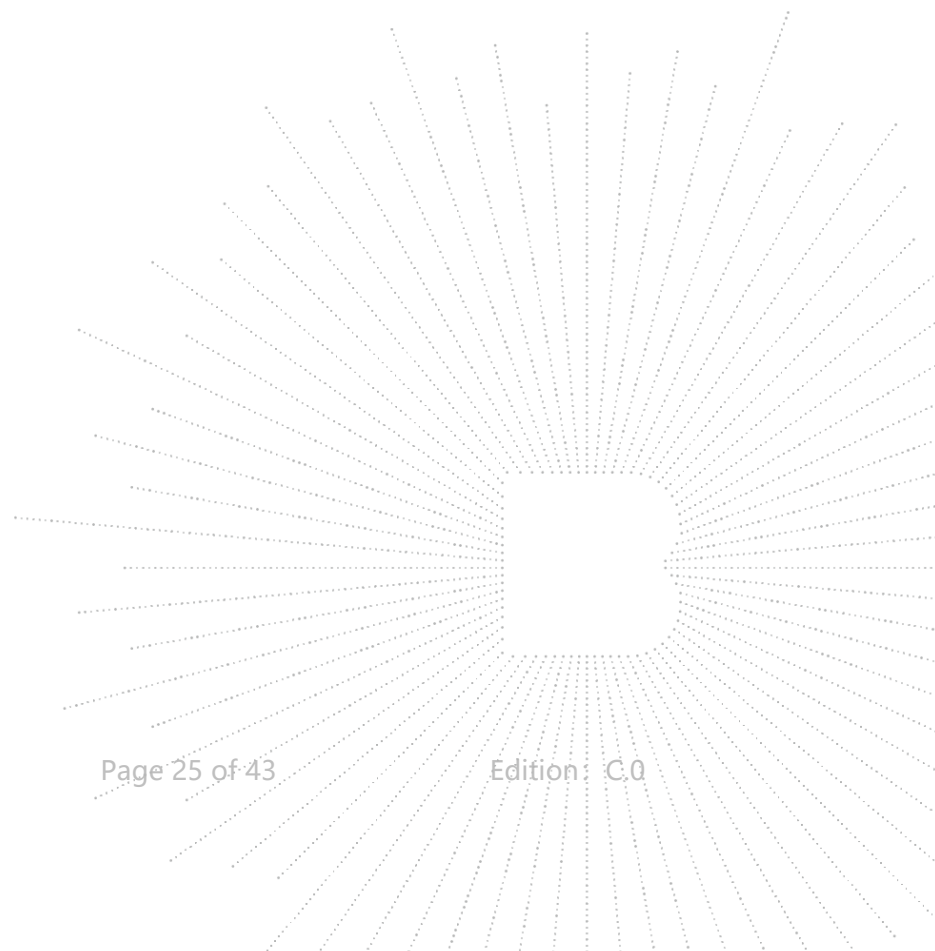

## 11. Continuous RF Electromagnetic Field Disturbances (RS)

### 11.1 Test Specification

<b>Basic standard</b>	: IEC 61000-4-3
<b>Test Port</b>	: Enclosure port
<b>Step Size</b>	: 1%
<b>Modulation</b>	: 1kHz, 80% AM
<b>Dwell Time</b>	: 1 second
<b>Polarization</b>	: Horizontal & Vertical

### 11.2 Block Diagram of Test Setup

Below 1GHz:

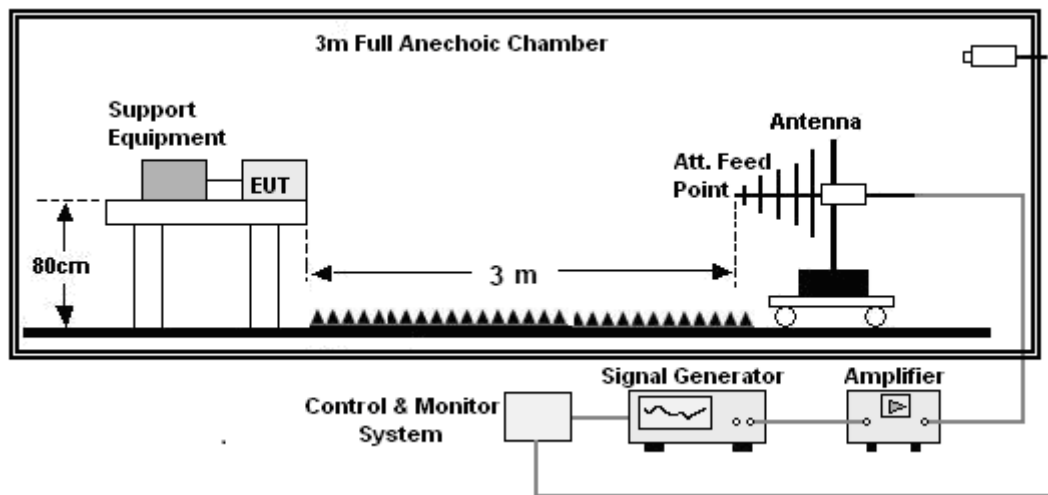

Above 1GHz:

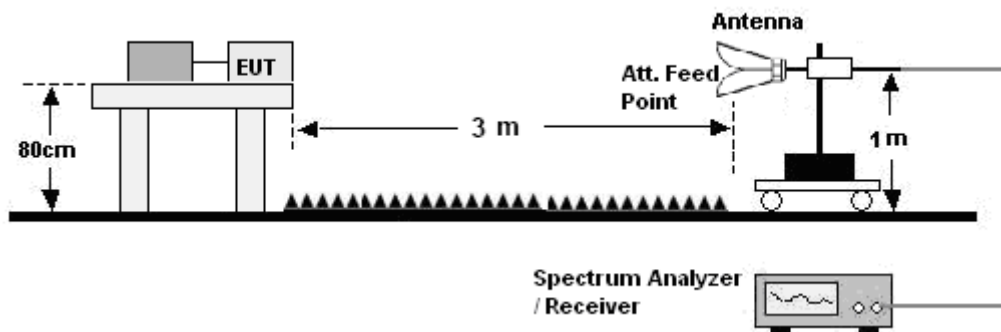

### 11.3 Test Procedure

- The testing was performed in a fully-anechoic chamber. The transmit antenna was located at a distance of 3 meters from the Product.
- The frequency range is swept from 80MHz to 1000MHz, 1800MHz, 2600MHz, 3500MHz, 5000MHz, with the signal 80% amplitude modulated with a 1 kHz sine wave, and the step size was 1%.
- The dwell time at each frequency shall not be less than the time necessary for the EUT to be exercised and to be able to respond, but should not exceed 5 s at each of the frequencies during the scan.
- The test was performed with the Product exposed to both vertically and horizontally polarized fields on each of the four sides.
- For Broadcast reception function: Group 2 not apply in this test.

### 11.4 Test Results

Temperature:	24.2 °C	Relative Humidity:	52%RH
Pressure:	101KPa	Test Mode:	Charging+Working/ Working
Test Voltage :	DC 5V From Adapter Input AC 230V/50Hz /DC 3.6V		

Frequency	Position	Field Strength (V/m)	Required Level	Performance Criterion
80 - 1000MHz, 1800MHz, 2600MHz, 3500MHz, 5000MHz	Front, Right, Back, Left	3	A	A

BCTC  
 3C  
 PPR  
 Report

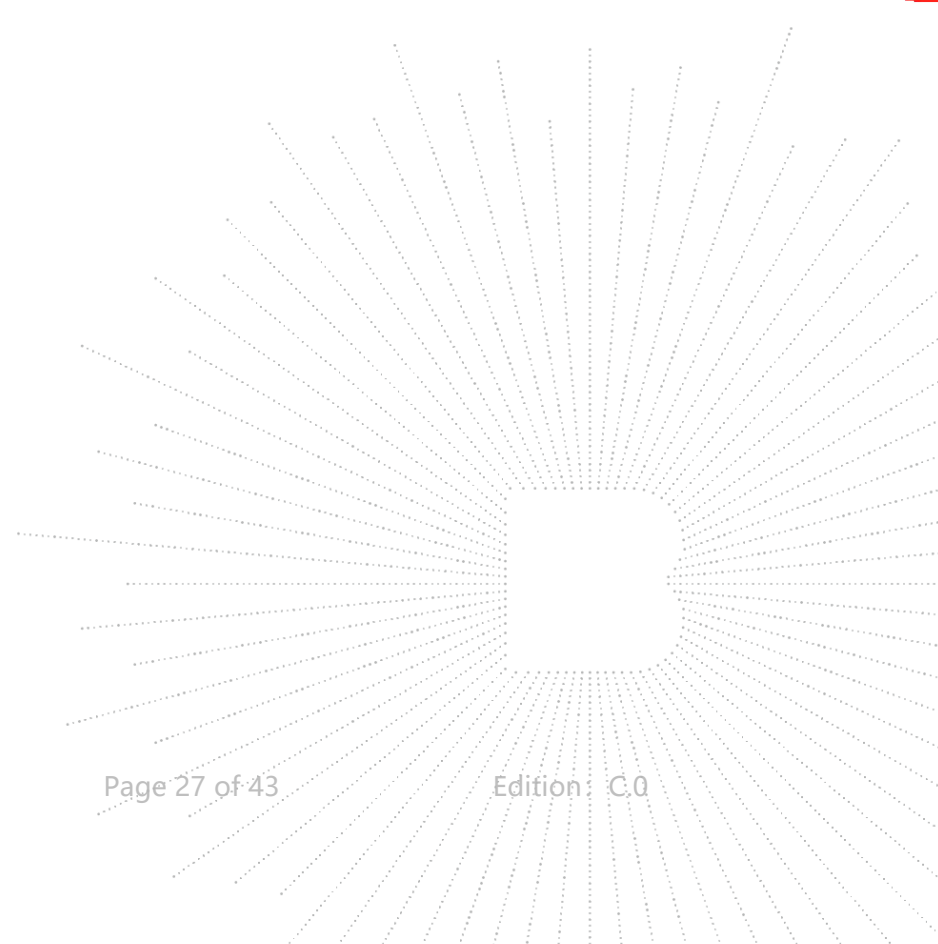

## 12. Electrical Fast Transients/Burst (EFT)

### 12.1 Test Specification

<b>Basic standard</b>	: IEC 61000-4-4
<b>Test Port</b>	: input ac/dc. power port
<b>Impulse Frequency</b>	: 5 kHz
<b>Impulse Wave-shape</b>	: 5/50 ns
<b>Burst Duration</b>	: 15 ms
<b>Burst Period</b>	: 300 ms
<b>Test Duration</b>	: 2 minutes per polarity

### 12.2 Block Diagram of EUT Test Setup

For input ac/dc. power port:

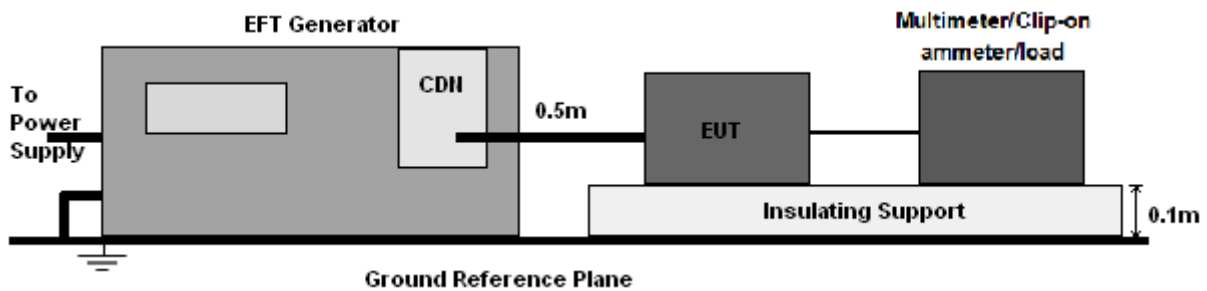

### 12.3 Test Procedure

- The Product and support units were located on a non-conductive table above ground reference plane.
- A 0.5m-long power cord was attached to Product during the test.

### 12.4 Test Results

Temperature:	24.7 °C	Relative Humidity:	56%RH
Pressure:	101KPa		
Test Voltage :	DC 5V From Adapter Input AC 230V/50Hz	Test Mode:	Charging+Working

Coupling	Voltage (kV)	Polarity	Required Level	Performance Criterion
AC MainsL-N	1.0	±	B	A

### 13. Surges Immunity Test

#### 13.1 Test Specification

<b>Basic standard</b>	: IEC 61000-4-5
<b>Test Port</b>	: input ac/dc. power port
<b>Wave-Shape</b>	: Open Circuit Voltage - 1.2 / 50 us Short Circuit Current - 8 / 20 us
<b>Pulse Repetition Rate</b>	: 1 pulse / min.
<b>Phase Angle</b>	: 0° / 90° / 180° / 270°
<b>Test Events</b>	: 5 pulses (positive & negative) for each polarity

#### 13.2 Block Diagram of EUT Test Setup

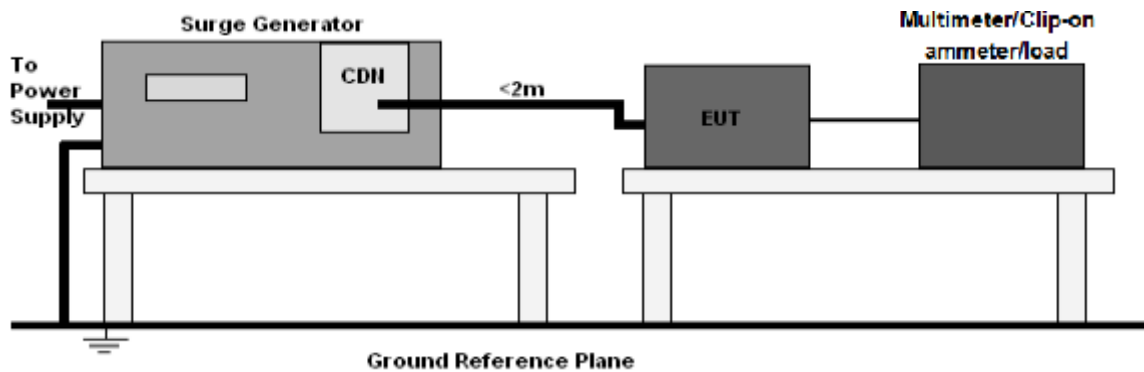

#### 13.3 Test Procedure

- The surge is to be applied to the Product power supply terminals via the capacitive coupling network. Decoupling networks are required in order to avoid possible adverse effects on equipment not under test that may be powered by the same lines, and to provide sufficient decoupling impedance to the surge wave.
- The power cord between the Product and the coupling/decoupling networks shall be 2 meters in length (or shorter). Interconnection line between the Product and the coupling/decoupling networks shall be 2 meters in length (or shorter).

#### 13.4 Test Result

Temperature:	24.7 °C	Relative Humidity:	56%RH
Pressure:	101KPa	Test Mode:	Charging+Working
Test Voltage :	DC 5V From Adapter Input AC 230V/50Hz		

Coupling Line	Voltage(kV)	Phase Angle	Required Level	Performance Criterion
L - N	+ 1.0	90°	C	A
	- 1.0	270°		

## 14. Continuous Induced RF Disturbances (CS)

### 14.1 Test Specification

<b>Basic standard</b>	: IEC 61000-4-6
<b>Test Port</b>	: input ac/dc. power port
<b>Step Size</b>	: 1%
<b>Modulation</b>	: 1kHz, 80% AM
<b>Dwell Time</b>	: 1 second

### 14.2 Block Diagram of EUT Test Setup

For input ac/ac. power port:

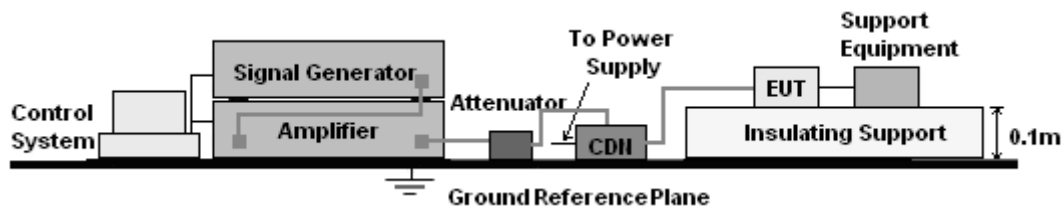

### 14.3 Test Procedure

For input ac/dc. power port:

- The Product and support units were located at a ground reference plane with the interposition of a 0.1 m thickness insulating support and the CDN was located on GRP directly.
- The frequency range is swept from 150 kHz to 10MHz, 10MHz to 30MHz, 30MHz to 80MHz with the signal 80% amplitude modulated with a 1 kHz sine wave, and the step size was 1% of fundamental.
- The dwell time at each frequency shall be not less than the time necessary for the Product to be able to respond.

### 14.4 Test Result

Temperature:	24.7 °C	Relative Humidity:	56%RH
Pressure:	101KPa	Test Mode:	Charging+Working
Test Voltage :	DC 5V From Adapter Input AC 230V/50Hz		

Inject Line	Frequency (MHz)	Voltage Level (V r.m.s.)	Required Level	Performance Criterion
a.c. port	0.15 - 10	3	A	A
	10 to 30	3 to 1	A	A
	30 to 80	1	A	A

## 15. Voltage Dips And Interruptions (DIPS)

### 15.1 Test Specification

<b>Basic standard</b>	: IEC 61000-4-11
<b>Test Port</b>	: input ac. power port
<b>Phase Angle</b>	: 0°, 180°
<b>Test cycle</b>	: 3 times

### 15.2 Block Diagram of EUT Test Setup

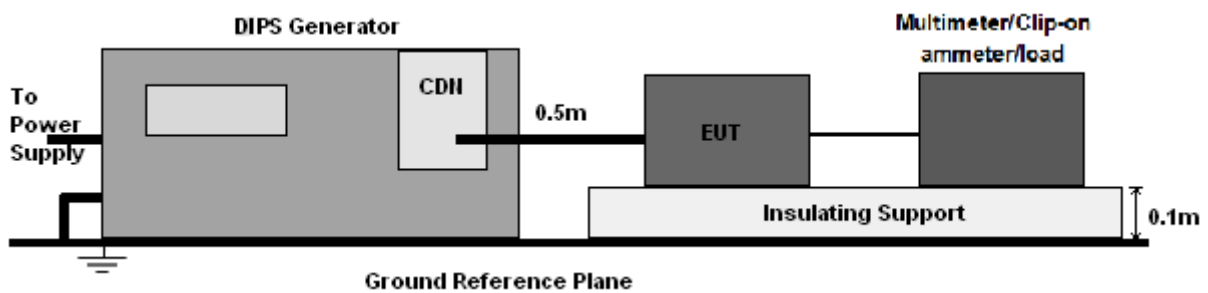

### 15.3 Test Procedure

- The Product and support units were located on a non-conductive table above ground floor.
- Set the parameter of tests and then perform the test software of test simulator.
- Conditions changes to occur at 0 degree crossover point of the voltage waveform.

### 15.4 Test Result

Temperature:	24.7 °C	Relative Humidity:	56%RH
Pressure:	101KPa		
Test Voltage :	DC 5V From Adapter Input AC 230V/50Hz	Test Mode:	Charging+Working

Test Level % $U_T$	Voltage dips in % $U_T$	Duration ( ms )	Required Level	Performance Criterion
< 5	≥95	10	B	A
70	30	500	B	A
<b>Voltage Interruptions:</b>				
< 5	≥95	5000	C	B*
Remark: $T (s) = 1 / F (Hz)$ ;				
Note*: B: The EUT Unable to working during testing, and it end of the test can be restored automatically				

**16. EUT Photographs**

EUT Photo 1



EUT Photo 2

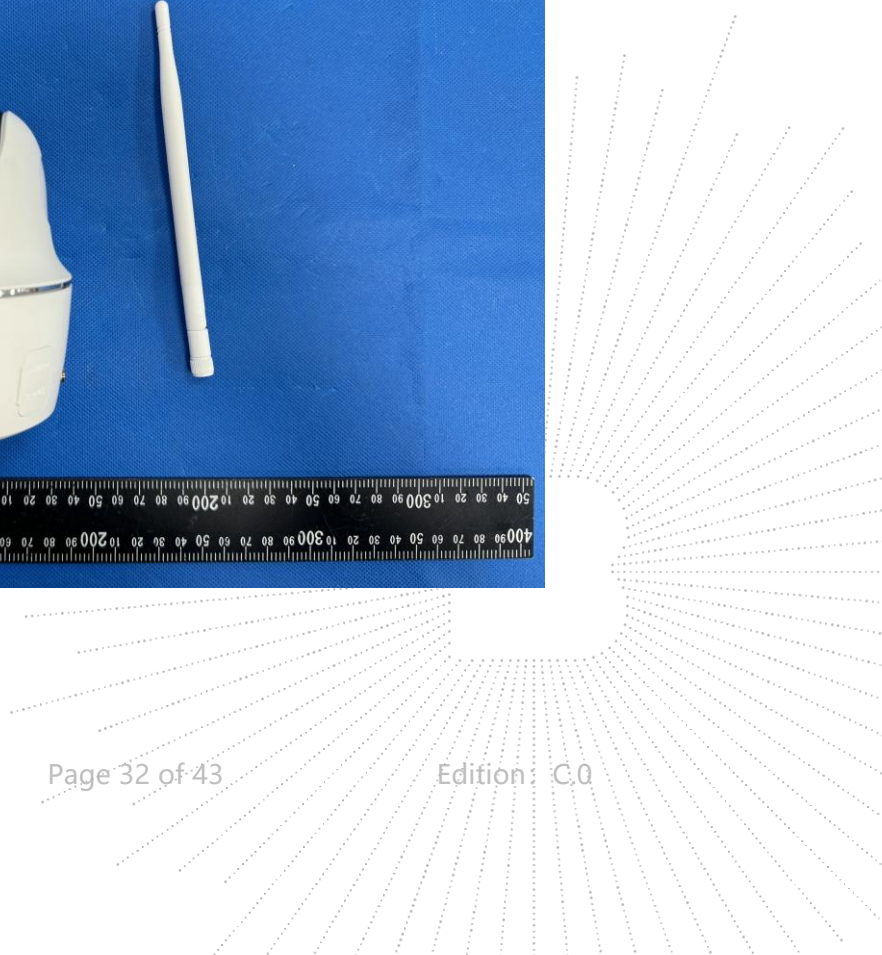
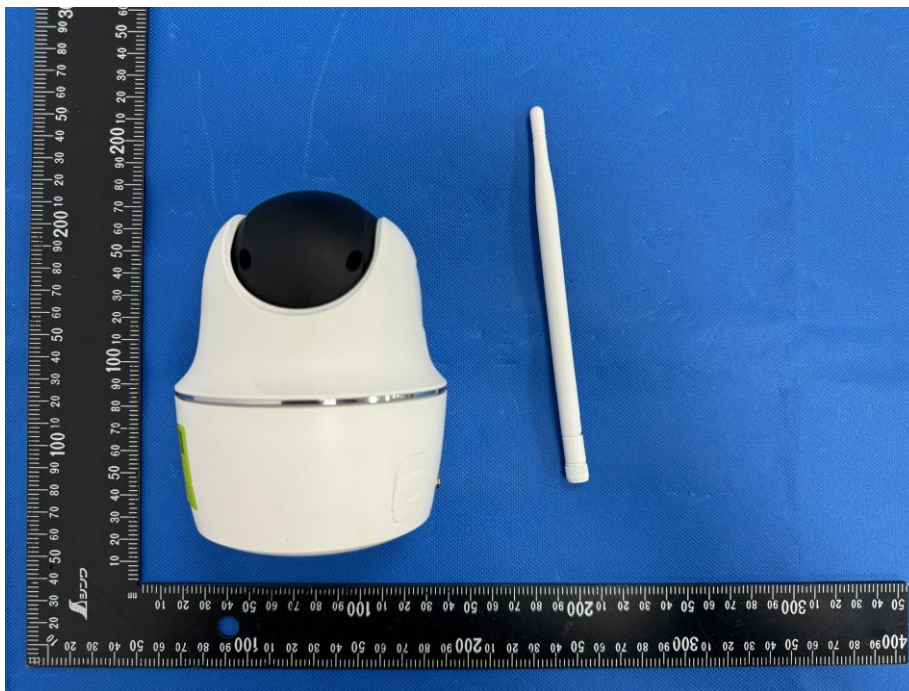

EUT Photo 3

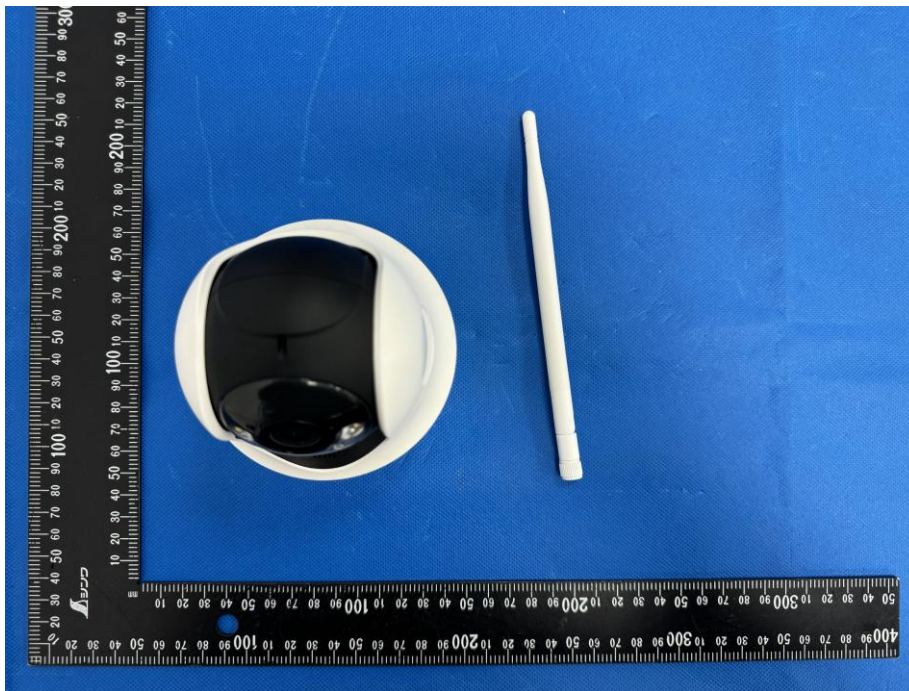

EUT Photo 4



TC  
BC  
PPR  
Report



EUT Photo 5

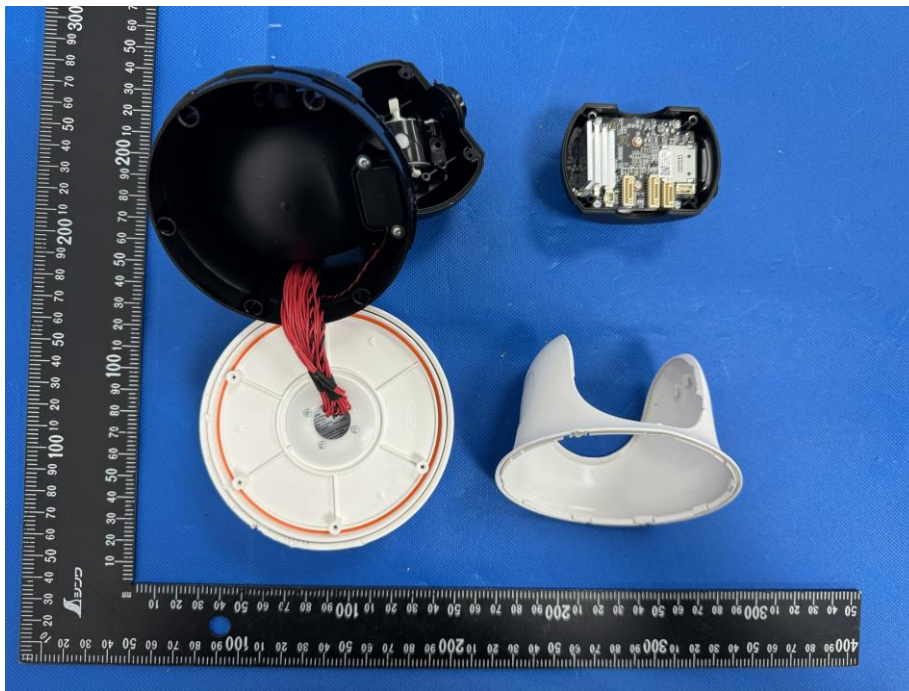

EUT Photo 6

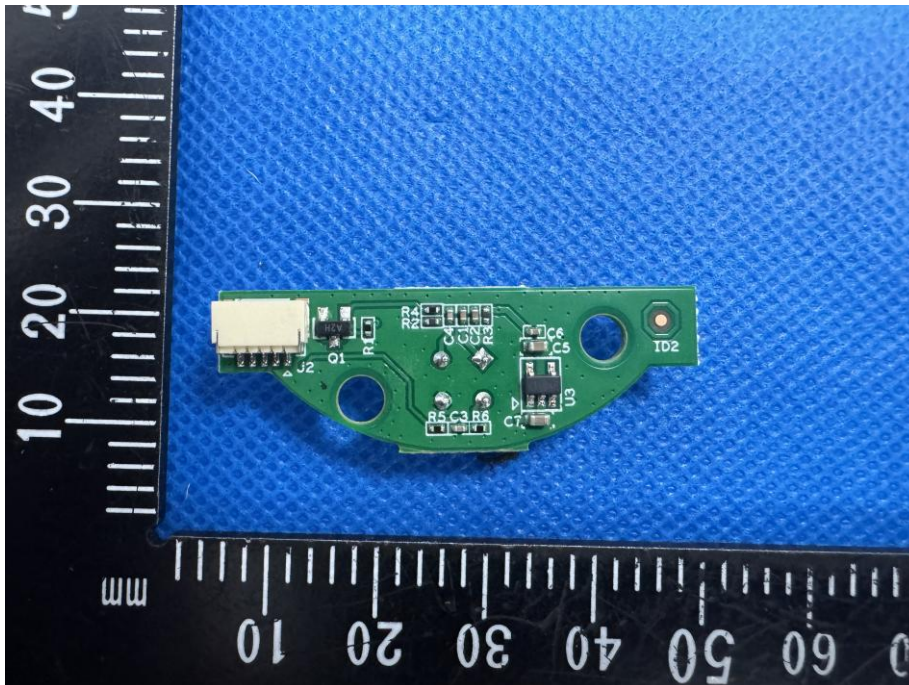

TEC  
TO  
OVB  
t See

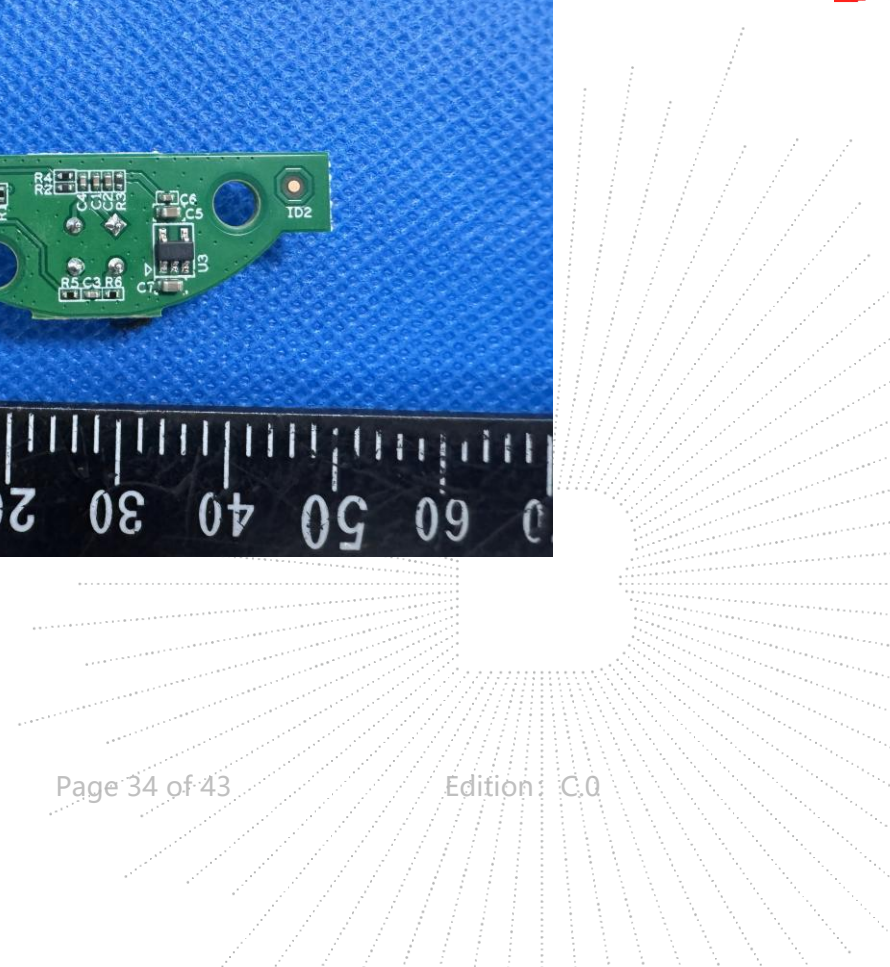

EUT Photo 7

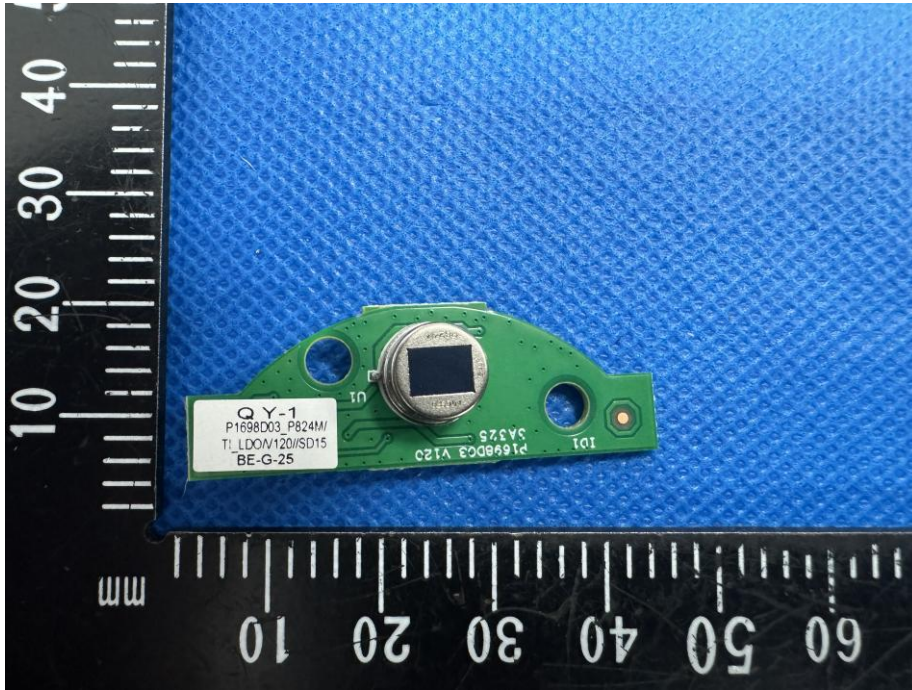

EUT Photo 8

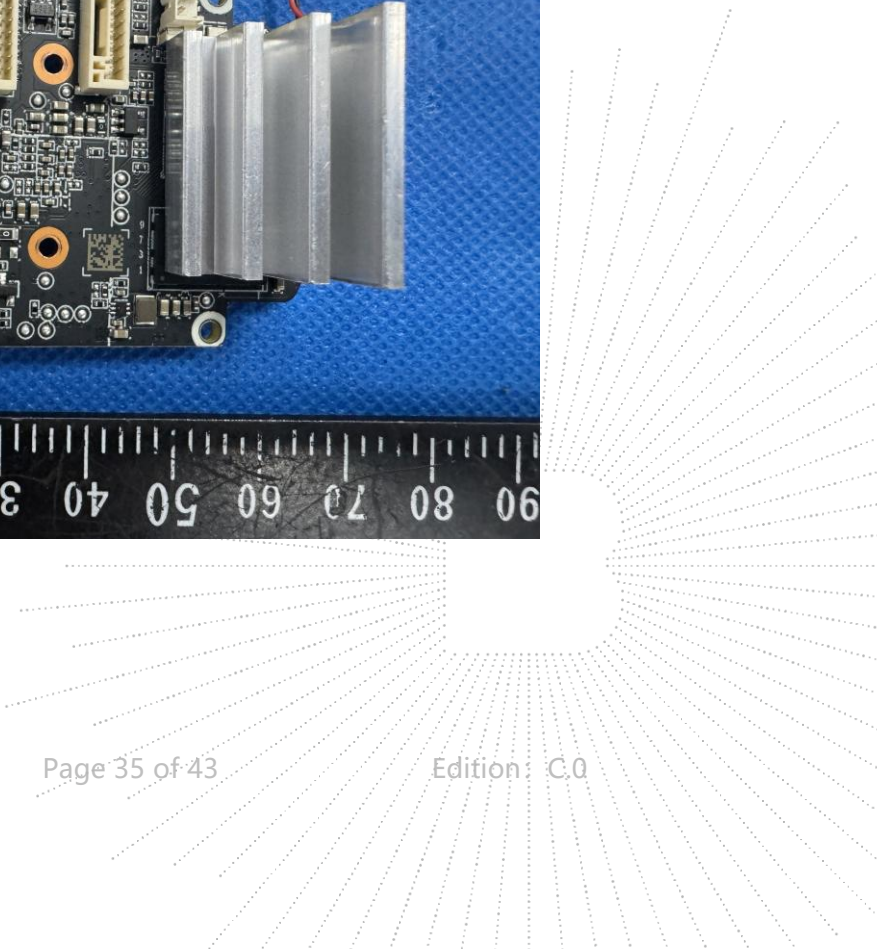
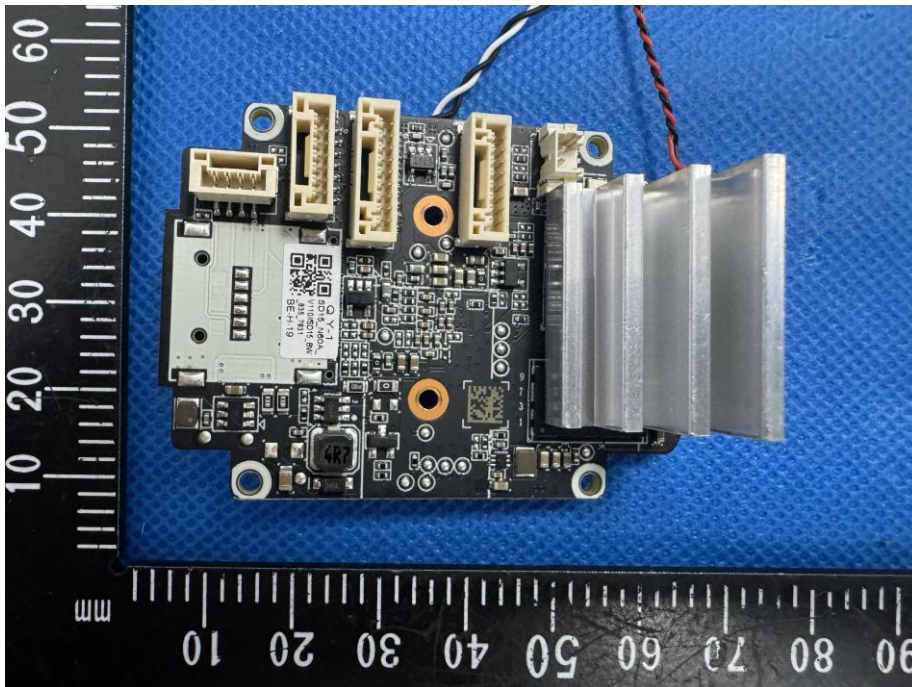

EUT Photo 9

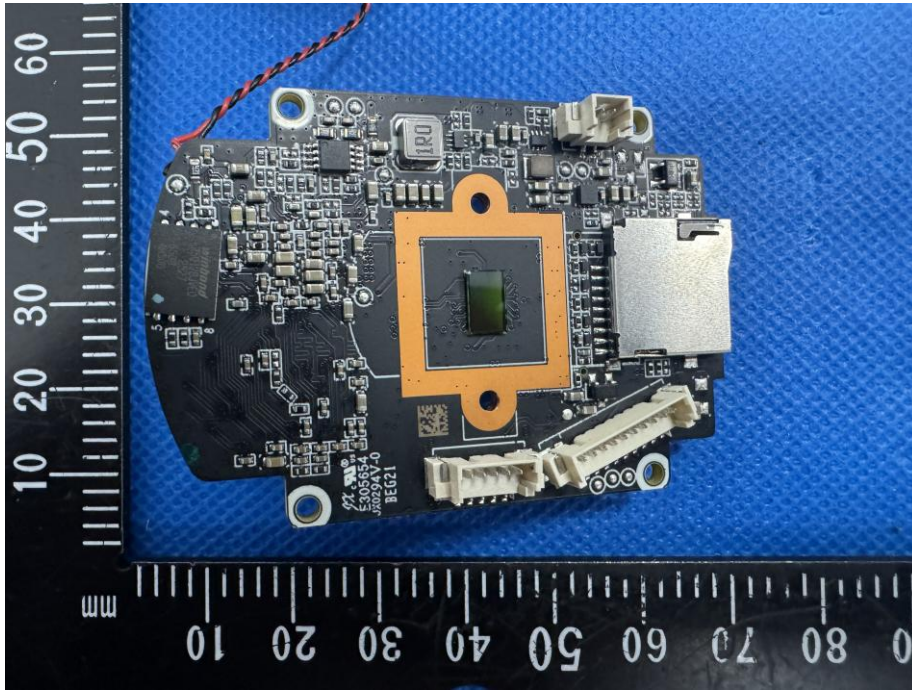

EUT Photo 10

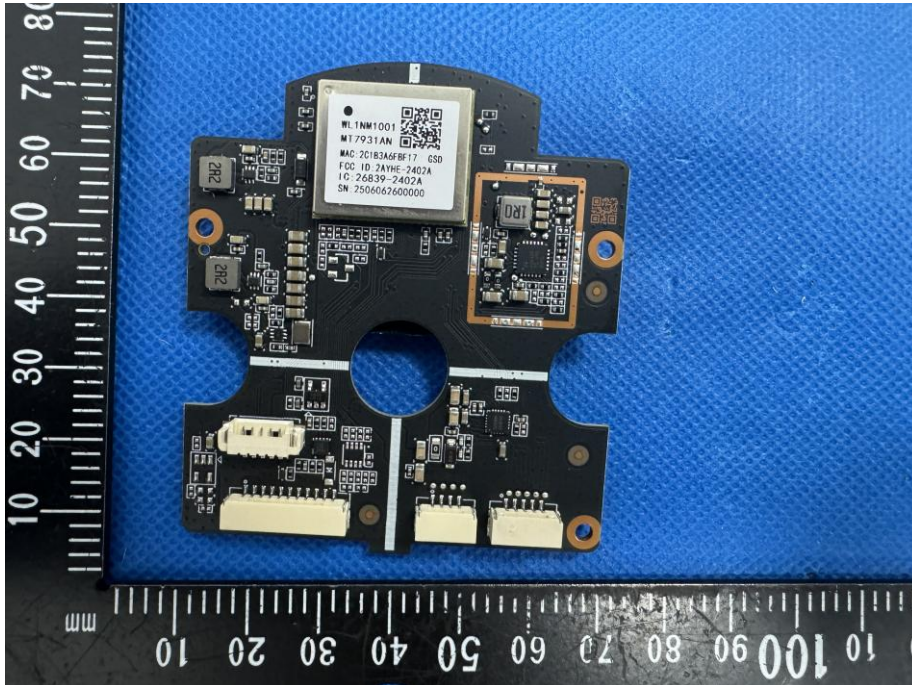

CO., LTD

EUT Photo 11

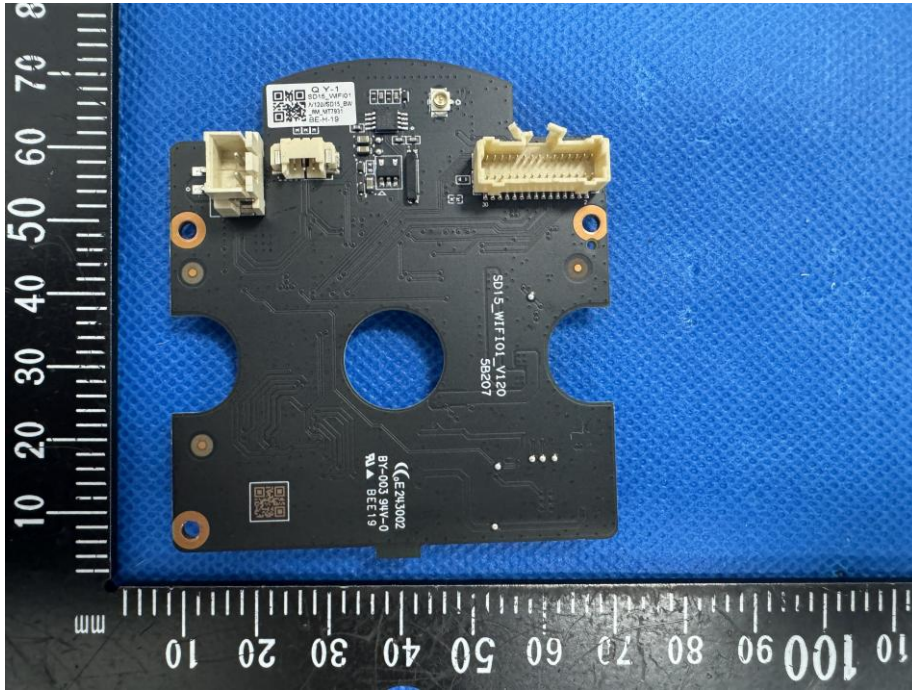

EUT Photo 12

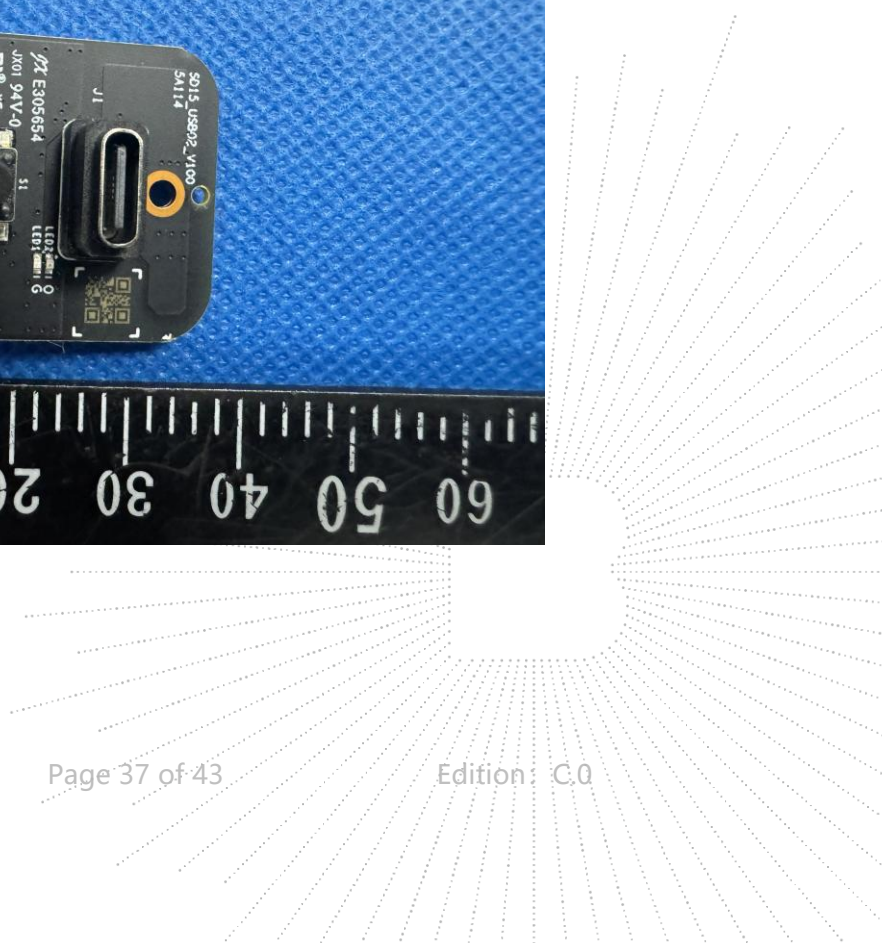
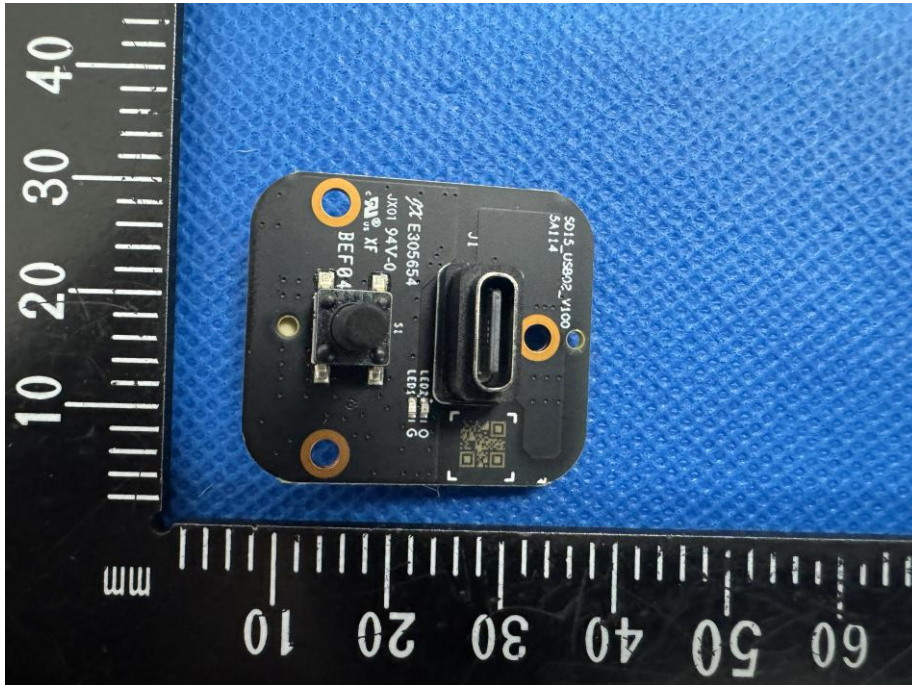

EUT Photo 13

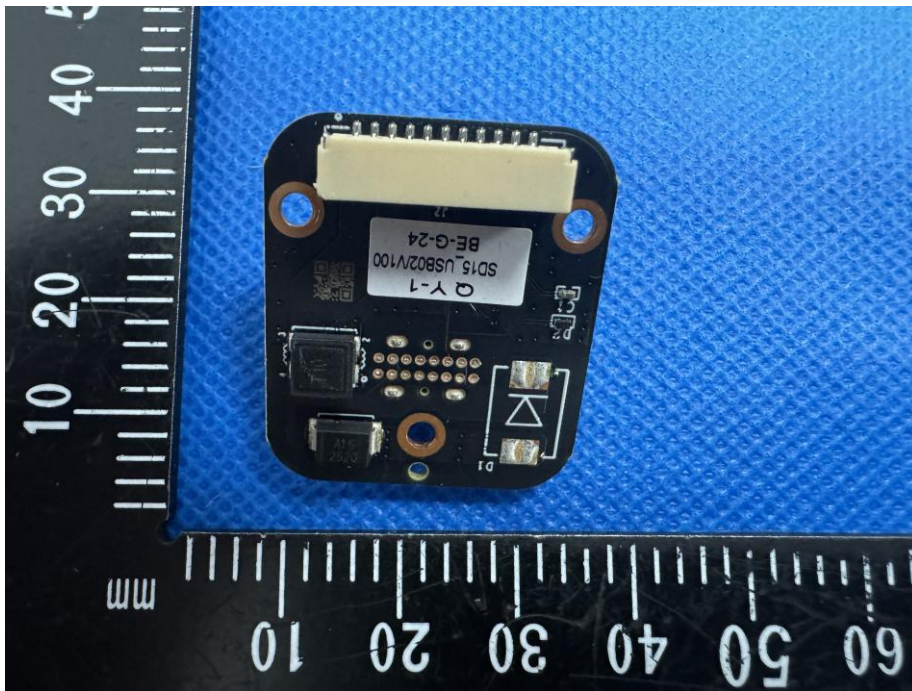

EUT Photo 14



STATION B



## 17. EUT Test Setup Photographs

Conducted emissions



Radiated emissions (Below 1GHz)

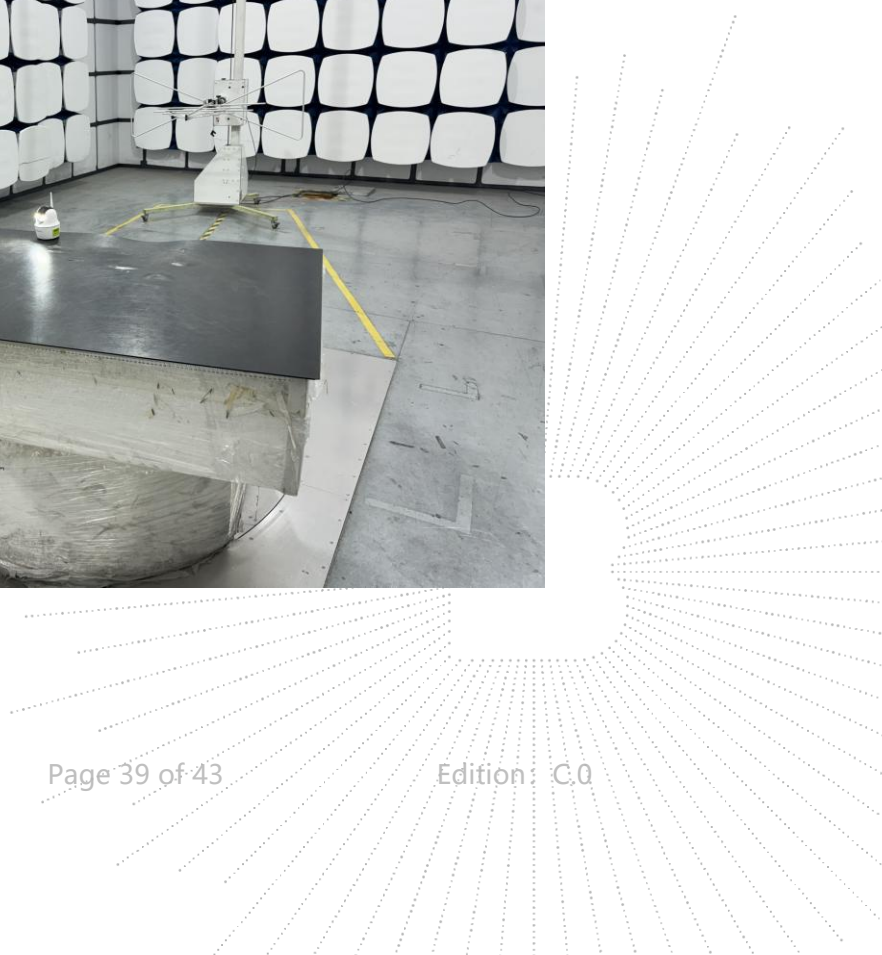

## Radiated emissions (Above 1GHz)



F



ESD

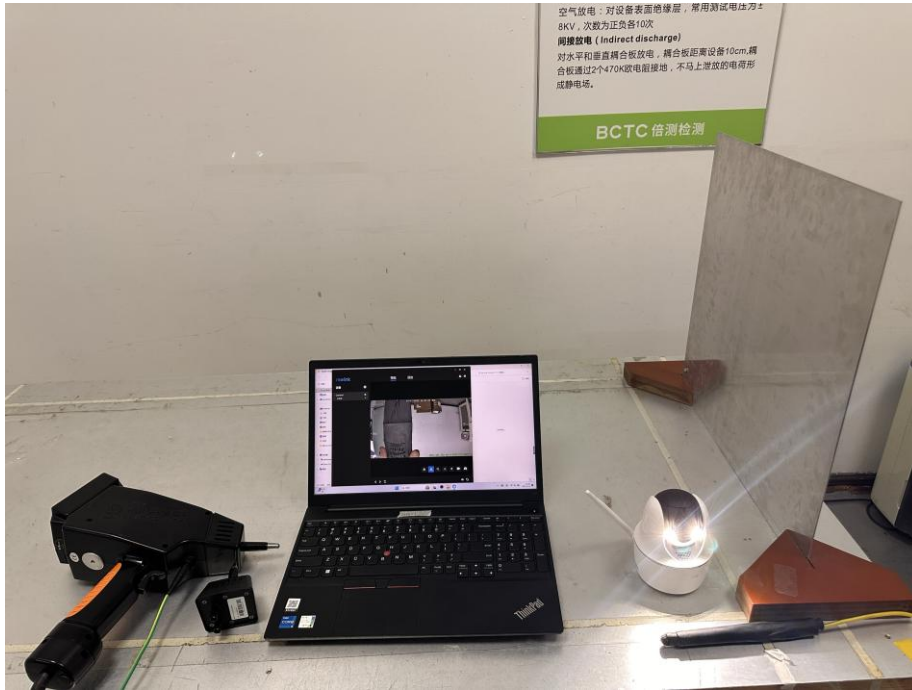

RS

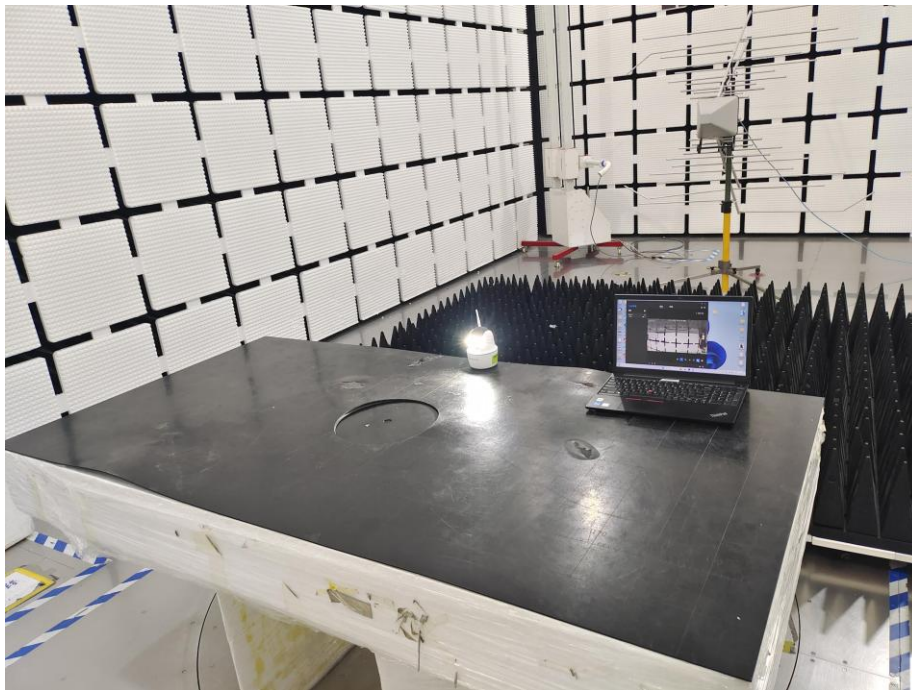

TEST  
FOR  
OVER  
seal

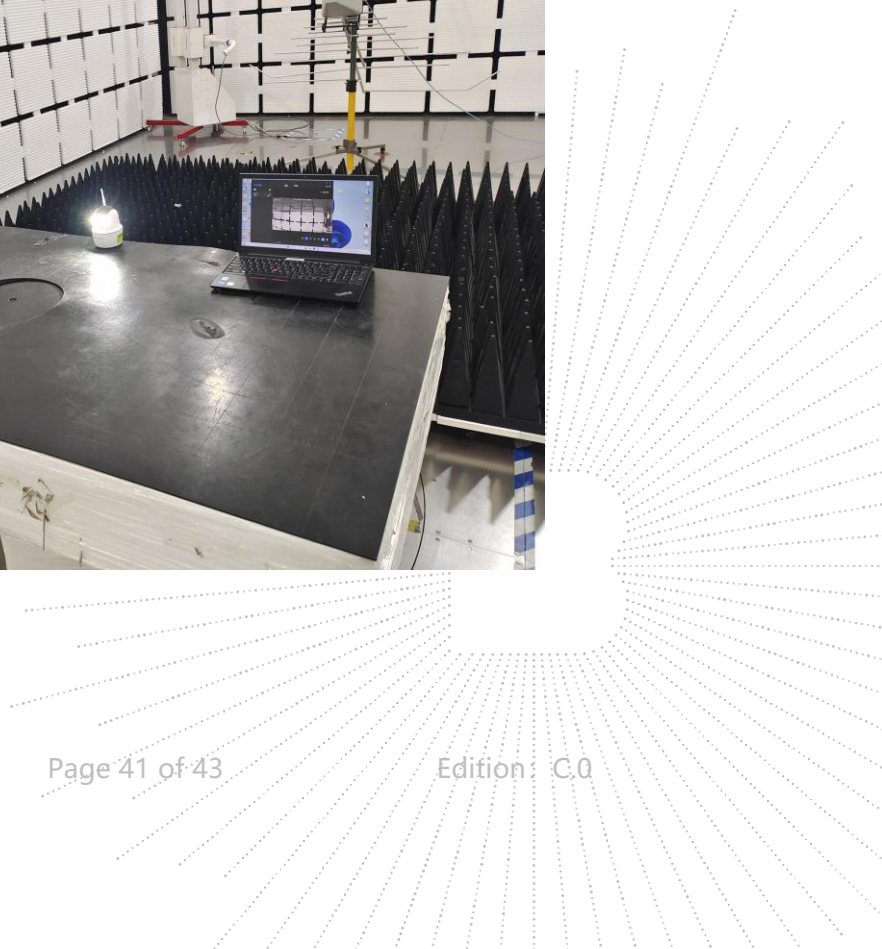

CS

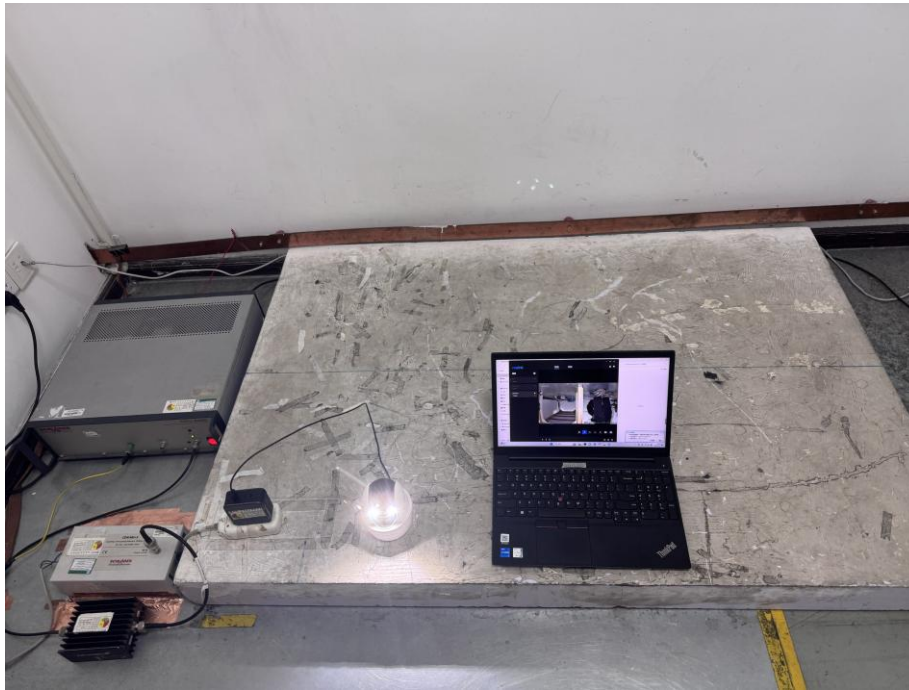
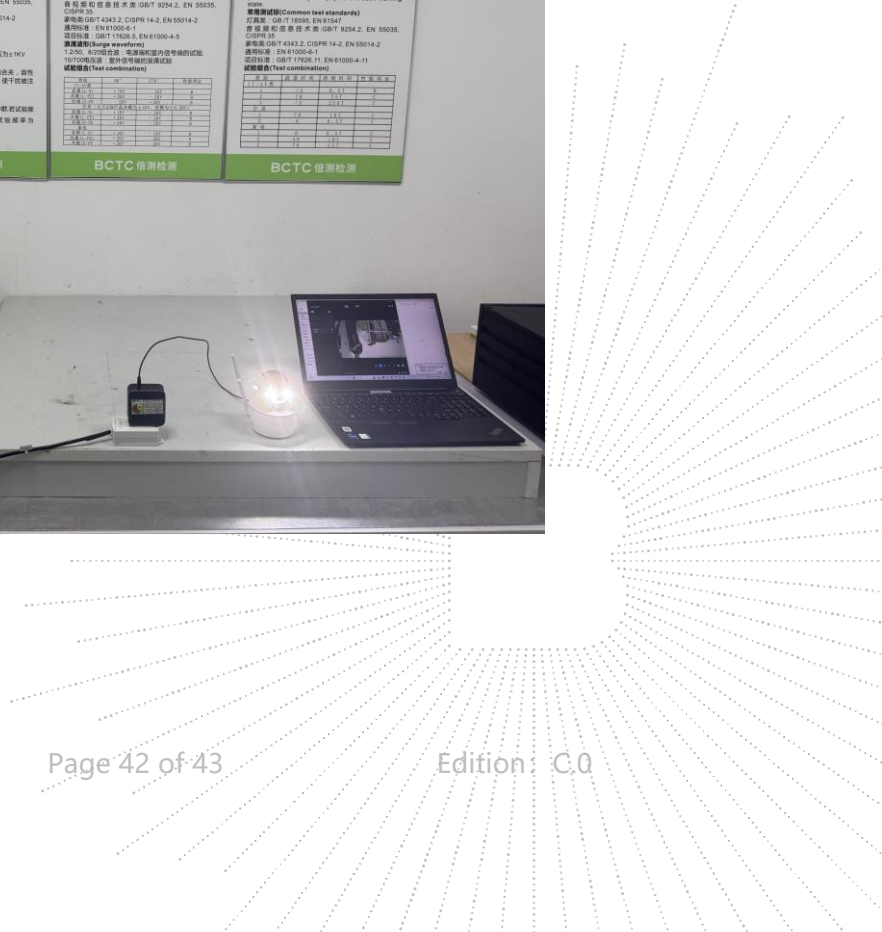
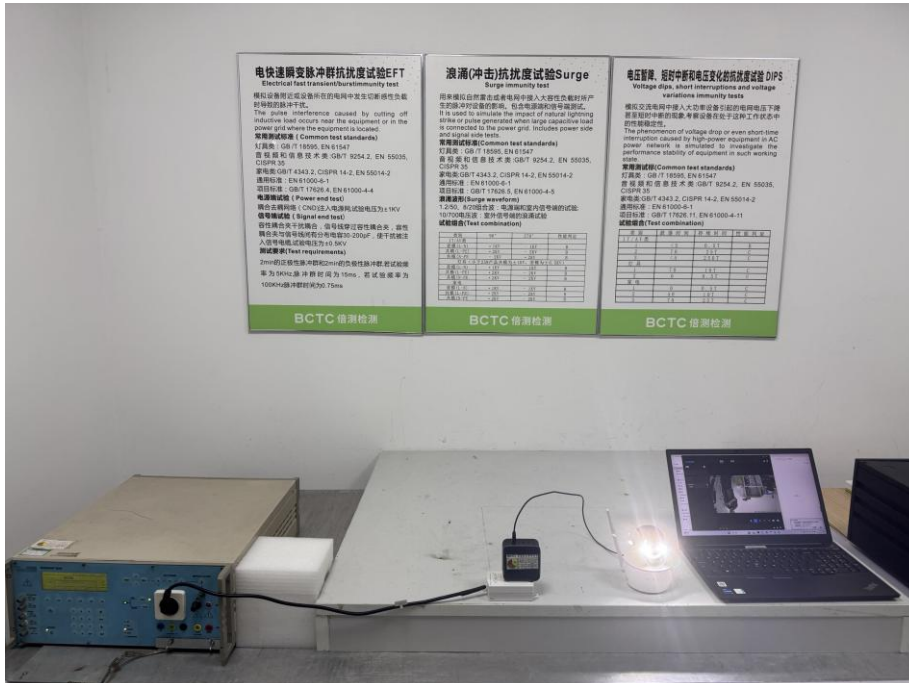
**EFT & Dips & Surge**

**STATEMENT**

1. The equipment lists are traceable to the national reference standards.
2. The test report can not be partially copied unless prior written approval is issued from our lab.
3. The test report is invalid without the "special seal for inspection and testing".
4. The test report is invalid without the signature of the approver.
5. The test process and test result is only related to the Unit Under Test.
6. Sample information is provided by the client and the laboratory is not responsible for its authenticity.
7. The quality system of our laboratory is in accordance with ISO/IEC17025.
8. If there is any objection to this test report, the client should inform issuing laboratory within 15 days from the date of receiving test report.

## Address:

1-2/F., Building B, Pengzhou Industrial Park, No.158, Fuyuan 1st Road, Zhancheng, Fuhai Subdistrict, Bao'an District, Shenzhen, Guangdong, China

TEL: 400-788-9558

P.C.: 518103

FAX: 0755-33229357

Website: <http://www.chnbctc.com>Consultation E-mail: [bctc@bctc-lab.com.cn](mailto:bctc@bctc-lab.com.cn)Complaint/Advice E-mail: [advice@bctc-lab.com.cn](mailto:advice@bctc-lab.com.cn)

※※※※※ END ※※※※※

CO.LTD