

# TEST REPORT

Report No.: BCTC2401943168E

---

Applicant: REOLINK INNOVATION LIMITED

---

Product Name: IP Camera

---

Test Model: P324

---

Tested Date: 2024-01-29 to 2024-02-04

---

Issued Date: 2024-04-01

---

**Shenzhen BCTC Testing Co., Ltd.**



Product Name: IP Camera

Trademark:



Model/Type Reference: P324

Prepared For: REOLINK INNOVATION LIMITED

Address: FLAT/RM 705 7/F FA YUEN COMMERCIAL BUILDING 75-77 FA YUEN STREET MONG KOK KL HONG KONG

Manufacturer: REOLINK INNOVATION LIMITED

Address: FLAT/RM 705 7/F FA YUEN COMMERCIAL BUILDING 75-77 FA YUEN STREET MONG KOK KL HONG KONG

Prepared By: Shenzhen BCTC Testing Co., Ltd.

Address: 1-2/F., Building B, Pengzhou Industrial Park, No.158, Fuyuan 1st Road, Zhancheng, Fuhai Subdistrict, Bao'an District, Shenzhen, Guangdong, China.

Sample Received Date: 2024-01-29

Sample Tested Date: 2024-01-29 to 2024-02-04

Issue Date: 2024-04-01

Report No.: BCTC2401943168E

Test Standards: EN 55032:2015+A11:2020+A1:2020, EN 55035:2017+A11:2020

Test Results: PASS

Tested by:



Icey Chen/ Project Handler

Approved by:



Zero Zhou/Reviewer

The test report is effective only with both signature and specialized stamp. This result(s) shown in this report refer only to the sample(s) tested. Without written approval of Shenzhen BCTC Testing Co., Ltd, this report can't be reproduced except in full. The tested sample(s) and the sample information are provided by the client.



## Table Of Content

Test Report Declaration	Page
1. Version .....	4
2. Test Summary .....	5
3. Measurement Uncertainty .....	6
4. Product Information And Test Setup .....	7
4.1 Product Information.....	7
4.2 Test Setup Configuration .....	7
4.3 Support Equipment .....	7
4.4 Test Mode .....	8
5. Test Facility And Test Instrument Used.....	9
5.1 Test Facility.....	9
5.2 Test Instrument Used.....	9
6. Conducted Emissions.....	11
6.1 Block Diagram Of Test Setup.....	11
6.2 Limit .....	11
6.3 Test procedure.....	11
6.4 Test Result.....	12
7. Radiated Emissions Test.....	13
7.1 Block Diagram Of Test Setup.....	13
7.2 Limits.....	13
7.3 Test Procedure .....	13
7.4 Test Results .....	14
8. Immunity Test Of General The Performance Criteria .....	16
9. Electrostatic Discharge (ESD).....	17
9.1 Test Specification.....	17
9.2 Block Diagram of Test Setup .....	17
9.3 Test Procedure .....	17
9.4 Test Results .....	18
10. Continuous Rf Electromagnetic Field Disturbances (RS).....	19
10.1 Test Specification.....	19
10.2 Block Diagram of Test Setup .....	19
10.3 Test Procedure .....	19
10.4 Test Results .....	20
11. EUT Photographs.....	21
12. EUT Test Setup Photographs.....	25

(Note: N/A Means Not Applicable)

BCTC  
 BCTC  
 PPR  
 Report

**1. Version**

Report No.	Issue Date	Description	Approved
BCTC2401943168E	2024-04-01	original	Valid

TEC  
TC  
OVB  
t See

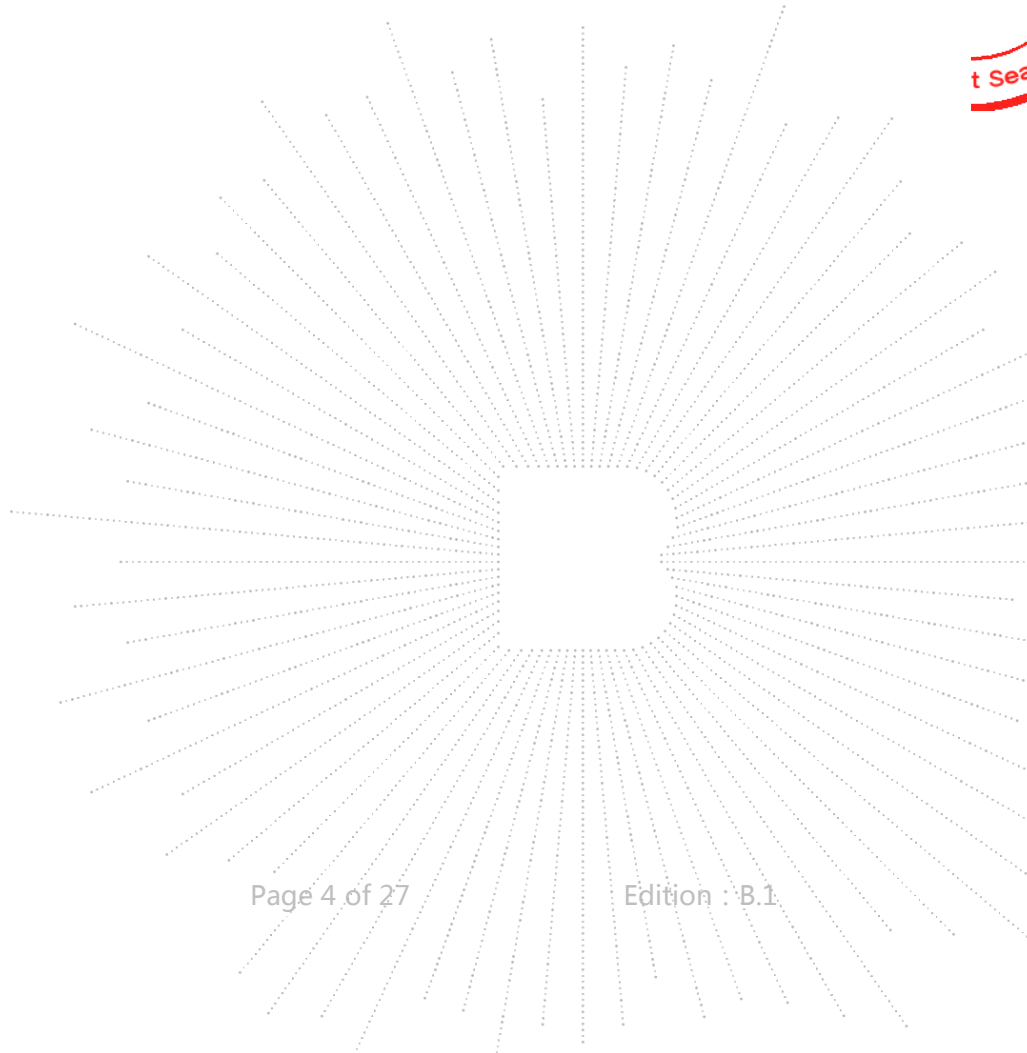

## 2. Test Summary

The Product has been tested according to the following specifications:

EMISSION		
Standard	Test Item	Test result
EN 55032	Conducted emissions from the AC mains power ports	N/A <sup>3</sup>
EN 55032	Asymmetric mode conducted emissions	Pass
EN 55032	Conducted differential voltage emissions	N/A <sup>2</sup>
EN 55032	Radiated emissions	Pass

IMMUNITY (EN 55035)		
Standard	Test Item	Test result
EN 55035	Electrostatic discharge (ESD)	Pass
EN 55035	Continuous RF electromagnetic field disturbances(RS)	Pass
EN 55035	Electrical fast transients/burst (EFT)	N/A <sup>3</sup>
EN 55035	Surges	N/A <sup>3</sup>
EN 55035	Continuous induced RF disturbances (CS)	N/A <sup>3</sup>
EN 55035	Broadband impulse noise disturbances, repetitive	N/A <sup>4</sup>
EN 55035	Broadband impulse noise disturbances, isolated	N/A <sup>4</sup>
EN 55035	Power frequency magnetic field (PFMF)	N/A <sup>5</sup>
EN 55035	Voltage dips and interruptions (DIPS)	N/A <sup>3</sup>

Remark:

1. Applicable to ports listed above and intended to connect to cables longer than 3 m.
2. The Product has no antenna port.
3. The EUT is powered by the DC only , the test item is not applicable
4. Applicable only to CPE xDSL ports.
5. The Product doesn't contain any device susceptible to magnetic fields.

### 3. Measurement Uncertainty

Where relevant, the following measurement uncertainty levels have been estimated for tests performed on the Product as specified in CISPR 16-4-2. This uncertainty represents an expanded uncertainty expressed at approximately the 95% confidence level using a coverage factor of  $k=2$ .

Test item	Value (dB)
Conducted Emission (150kHz-30MHz)	3.10
Radiated Emission(30MHz~200MHz)	4.60
Radiated Emission(200MHz~1GHz)	5.20
Radiated Emission(1GHz~6GHz)	5.20

A red curved stamp or mark, possibly a signature or official seal, located on the right side of the page.

## 4. Product Information And Test Setup

### 4.1 Product Information

**Ratings:**

The highest frequency of the internal sources of the EUT is (less than 108)MHz:

DC 12V

- less than 108 MHz, the measurement shall only be made up to 1 GHz.  
 between 108 MHz and 500 MHz, the measurement shall only be made up to 2 GHz.  
 between 500 MHz and 1 GHz, the measurement shall only be made up to 5 GHz.  
 above 1 GHz, the measurement shall be made up to 5 times the highest frequency or 6 GHz, whichever is less.

**Cable of Product**

No.	Cable Type	Quantity	Provider	Length (m)	Specification	Note
1	--	--	--	--	--	--
2	--	--	--	--	--	--

### 4.2 Test Setup Configuration

See test photographs attached in EUT TEST SETUP Photographs for the actual connections between Product and support equipment.

### 4.3 Support Equipment

No.	Device Type	Brand	Model	Series No.	Note
1.	PC	Lenovo	ThinkPad E14 Gen2	SPP1F35526	---

**Notes:**

- All the equipment/cables were placed in the worst-case configuration to maximize the emission during the test.
- Grounding was established in accordance with the manufacturer's requirements and conditions for the intended use.

#### 4.4 Test Mode

Test item	Test Mode	Test Voltage
Asymmetric mode conducted emissions(150KHz-30MHz) Class B	Working	DC 12V
Radiated emissions(30MHz-1GHz) Class B	Working	DC 12V
Electrostatic discharge (ESD) B <input checked="" type="checkbox"/> Air Discharge: $\pm 8\text{Kv}$ <input checked="" type="checkbox"/> Contact Discharge: $\pm 4\text{kV}$ <input checked="" type="checkbox"/> HCP & VCP: $\pm 4\text{Kv}$ 10 times each point/	Working	DC 12V
Continuous RF electromagnetic field disturbances(RS) 80MHz-1000MHz, 1800MHz, 2600MHz,3500MHz,5000MHz 3V/m,80% AM Front, Rear, Left, Right H/V	Working	DC 12V

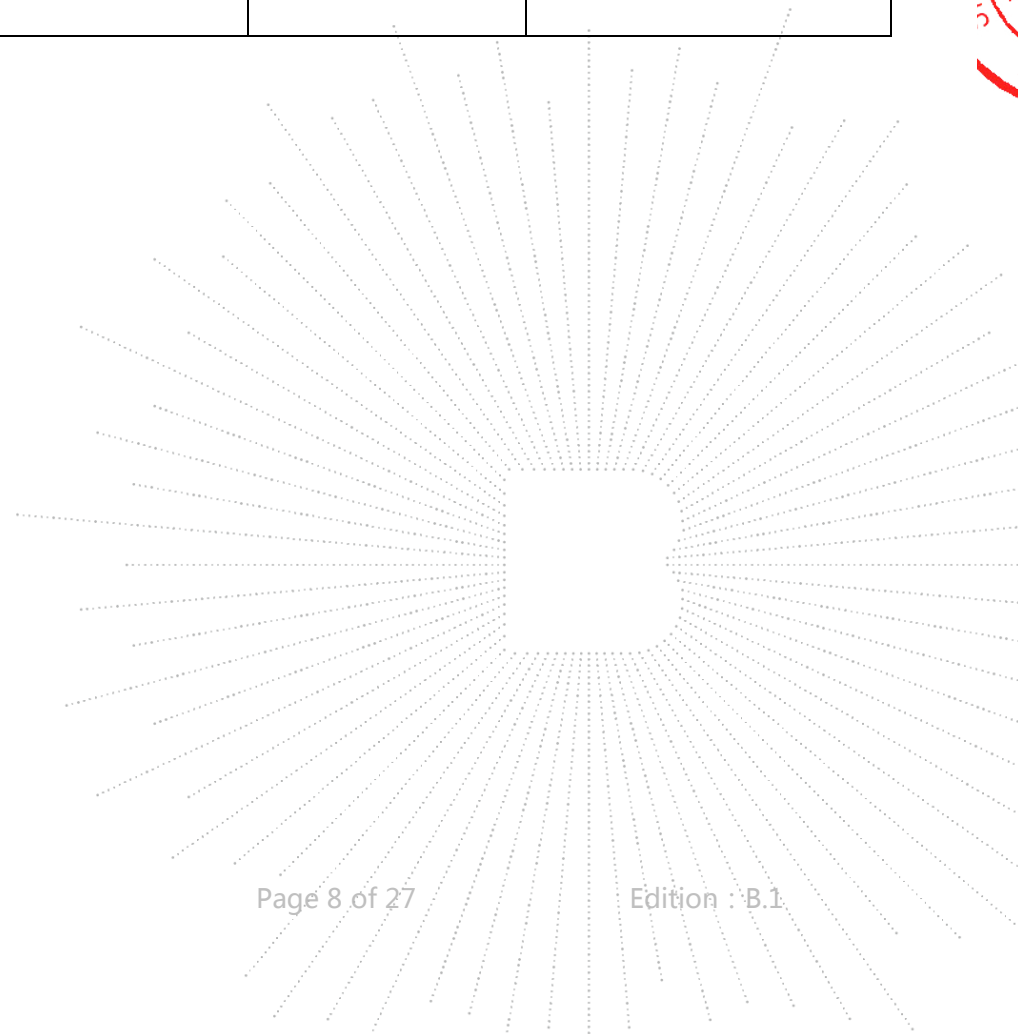

## 5. Test Facility And Test Instrument Used

### 5.1 Test Facility

All measurement facilities used to collect the measurement data are located at Shenzhen BCTC Testing Co., Ltd. Address: 1-2/F., Building B, Pengzhou Industrial Park, No.158, Fuyuan 1st Road, Zhancheng, Fuhai Subdistrict, Bao'an District, Shenzhen, Guangdong, China. The site and apparatus are constructed in conformance with the requirements of ANSI C63.4 and CISPR 16-1-1 other equivalent standards.

### 5.2 Test Instrument Used

Conducted Emissions Test					
Equipment	Manufacturer	Model#	Serial#	Last Cal.	Next Cal.
Receiver	R&S	ESR3	102075	May 15, 2023	May 14, 2024
LISN	R&S	ENV216	101375	May 15, 2023	May 14, 2024
ISN	HPX	ISN T800	S1509001	May 15, 2023	May 14, 2024
Software	Frad	EZ-EMC	EMC-CON 3A1	\	\
Pulse limiter	Schwarzbeck	VTSD 9561-F	01323	Sept. 22, 2023	Sept. 21, 2024

Radiated Emissions Test (966 Chamber#01)					
Equipment	Manufacturer	Model#	Serial#	Last Cal.	Next Cal.
966 chamber	ChengYu	966 Room	966	May 15, 2023	May 14, 2026
Receiver	R&S	ESRP	101154	May 15, 2023	May 14, 2024
Receiver	R&S	ESR3	102075	May 15, 2023	May 14, 2024
Amplifier	SKET	LAPA_01G18 G-45dB	SK202104090 1	May 15, 2023	May 14, 2024
Amplifier	Schwarzbeck	BBV9744	9744-0037	May 15, 2023	May 14, 2024
TRILOG Broadband Antenna	schwarzbeck	VULB9163	942	May 29, 2023	May 28, 2024
Horn Antenna	schwarzbeck	BBHA9120D	1541	May 31, 2023	May 30, 2024
Software	Frad	EZ-EMC	FA-03A2 RE	\	\

Electrostatic Discharge Test					
Equipment	Manufacturer	Model#	Serial#	Last Cal.	Next Cal.
ESD Tester	KIKUSUI	KES4201A	UH002321	May 15, 2023	May 14, 2024

Continuous RF Electromagnetic Field Disturbances Test					
Equipment	Manufacturer	Model#	Serial#	Last Cal.	Next Cal.
Power meter	Keysight	E4419	A00065	May 15, 2023	May 14, 2024
Power sensor	Keysight	E9300A	US39211659	May 15, 2023	May 14, 2024
Power sensor	Keysight	E9300A	US39211305	May 15, 2023	May 14, 2024
Amplifier	SKET	HAP_801000 -250W	21201805013	May 15, 2023	May 14, 2024
Amplifier	SKET	HAP_0103-7 5W	21201805014	May 15, 2023	May 14, 2024
Amplifier	SKET	HAP_0306-5 0W	21201805015	May 15, 2023	May 14, 2024
Stacked double Log.-Per. Antenna	Schwarzbeck	STLP 9129	00077	\	\
Field Probe	Narda	EP-601	611WX80256	May 15, 2023	May 14, 2024
Signal Generator	Agilent	N5181A	MY50143748	May 15, 2023	May 14, 2024
Software	SKET	EMC-S	1.2.0.18	\	\

TE  
TC  
OV  
t See

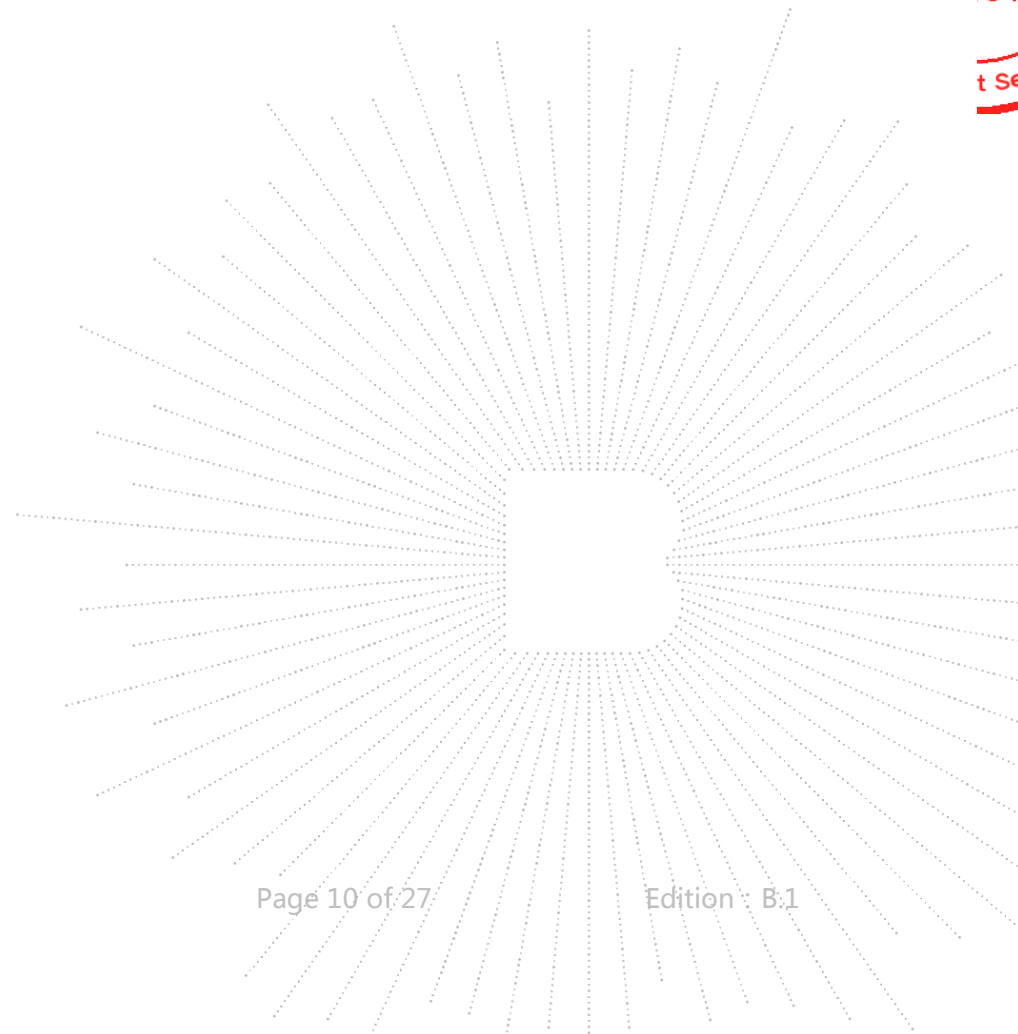

## 6. Conducted Emissions

### 6.1 Block Diagram Of Test Setup

For asymmetric mode ports:

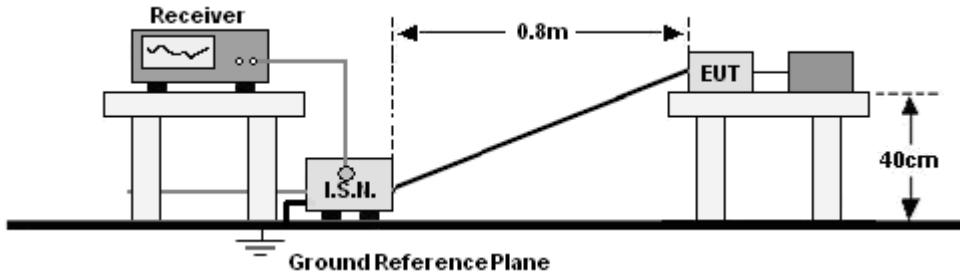

### 6.2 Limit

Limits for asymmetric mode conducted emissions of Class B MME

Frequency range (MHz)	Voltage Limits dB( $\mu$ V)		Current Limits dB( $\mu$ A)	
	Quasi-peak	Average	Quasi-peak	Average
0,15 to 0,50	84-74	74-64	40-30	30-20
0,50 to 30	74	64	30	20

Notes: \*Decreasing linearly with logarithm of frequency.

### 6.3 Test procedure

For asymmetric mode ports:

- The Product was placed on a non-conductive table 0.8 m above the horizontal ground reference plane, and 0.4 m from the vertical ground reference plane, and connected to the associated port through voltage probe.
- The RBW of the receiver was set at 9 kHz in 150 kHz ~ 30MHz with Peak and AVG detector in Max Hold mode. Run the receiver's pre-scan to record the maximum disturbance generated from Product in all power lines in the full band.
- For each frequency whose maximum record was higher or close to limit, measure its QP and AVG values and record.

## 6.4 Test Result

Temperature:	26 °C	Relative Humidity:	54%
Pressure:	101kPa	Phase :	TELE
Test Voltage :	DC 12V	Test Mode:	Working

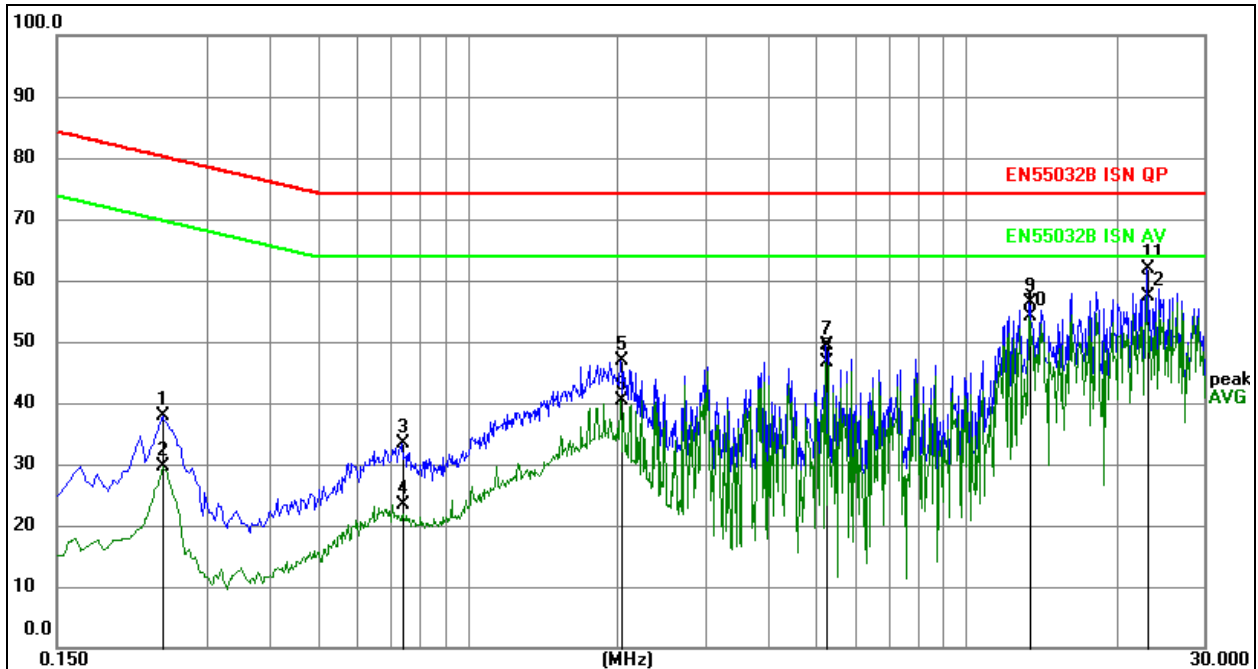

## Remark:

1. All readings are Quasi-Peak and Average values.
2. Factor = Insertion Loss + Cable Loss.
3. Measurement = Reading Level + Correct Factor
4. Over = Measurement - Limit

No.	Mk.	Freq.	Reading Level	Correct Factor	Measurement	Limit	Over	Detector
		MHz		dB	dBuV	dBuV	dB	
1		0.2445	18.22	19.58	37.80	79.94	-42.14	QP
2		0.2445	9.96	19.58	29.54	69.94	-40.40	AVG
3		0.7395	13.58	19.77	33.35	74.00	-40.65	QP
4		0.7395	3.50	19.77	23.27	64.00	-40.73	AVG
5		2.0310	27.04	19.85	46.89	74.00	-27.11	QP
6		2.0310	20.48	19.85	40.33	64.00	-23.67	AVG
7		5.2350	29.53	19.94	49.47	74.00	-24.53	QP
8		5.2350	26.67	19.94	46.61	64.00	-17.39	AVG
9		13.3575	36.27	20.02	56.29	74.00	-17.71	QP
10		13.3575	34.03	20.02	54.05	64.00	-9.95	AVG
11		23.1270	41.99	19.96	61.95	74.00	-12.05	QP
12	*	23.1270	37.50	19.96	57.46	64.00	-6.54	AVG

## 7. Radiated Emissions Test

### 7.1 Block Diagram Of Test Setup

30MHz ~ 1GHz:

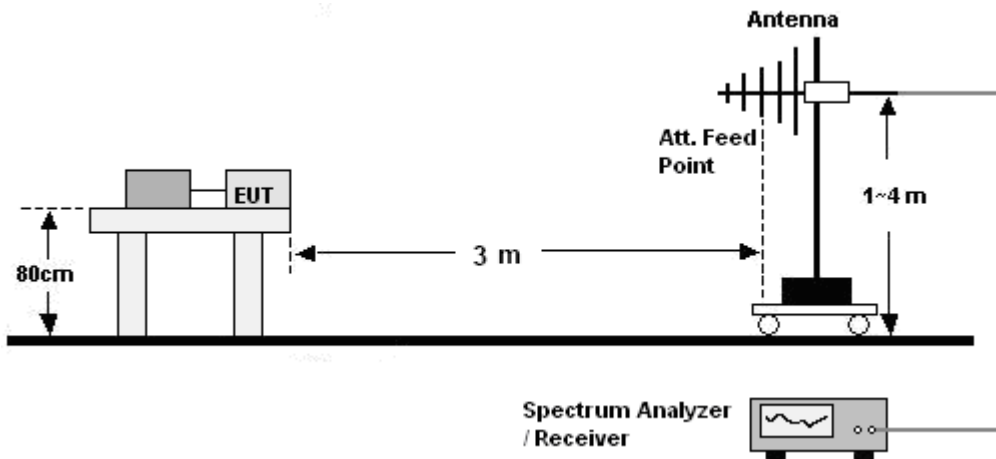

### 7.2 Limits

Limits for radiated disturbance of Class B MME

Frequency (MHz)	Quasi-peak limits at 3m dB( $\mu$ V/m)
30-230	40
230-1000	47

**Note:** The lower limit shall apply at the transition frequencies.

### 7.3 Test Procedure

30MHz ~ 1GHz:

- The Product was placed on the nonconductive turntable 0.8m above the ground in a semi anechoic chamber.
- Set the spectrum analyzer/receiver in Peak detector, Max Hold mode, and 120 kHz RBW. Record the maximum field strength of all the pre-scan process in the full band when the antenna is varied between 1~4 m in both horizontal and vertical, and the turntable is rotated from 0 to 360 degrees.
- For each frequency whose maximum record was higher or close to limit, measure its QP value: vary the antenna's height and rotate the turntable from 0 to 360 degrees to find the height and degree where Product radiated the maximum emission, then set the test frequency analyzer/receiver to QP Detector and specified bandwidth with Maximum Hold Mode, and record the maximum value.

## 7.4 Test Results

Temperature:	26 °C	Relative Humidity:	54%
Pressure:	101KPa	Phase :	Horizontal
Test Voltage :	DC 12V	Test Mode:	Working

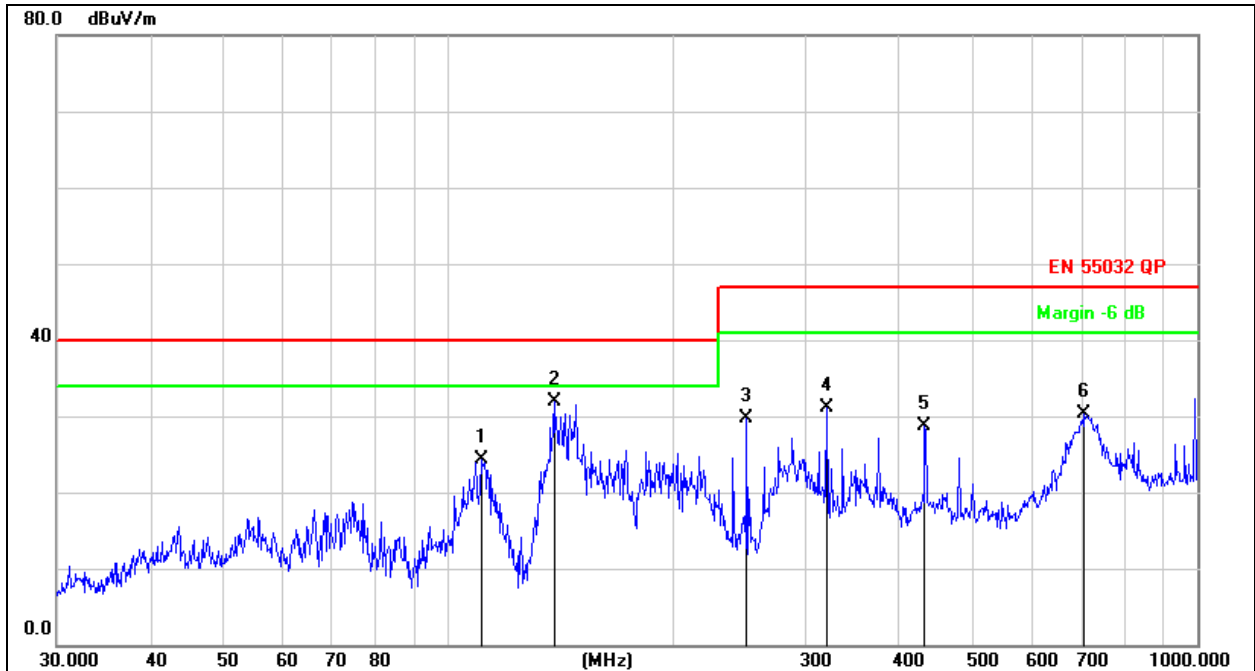

Remark:  
 1. Factor = Antenna Factor + Cable Loss – Pre-amplifier.  
 2. Measurement = Reading Level + Correct Factor  
 3. Over = Measurement - Limit

No.	Mk.	Freq. MHz	Reading Level dBuV	Correct Factor dB	Measure- ment dBuV/m	Limit dB/m	Over dB	Detector
1		110.5687	41.04	-16.67	24.37	40.00	-15.63	QP
2	*	138.3873	50.45	-18.62	31.83	40.00	-8.17	QP
3		250.3012	43.96	-14.28	29.68	47.00	-17.32	QP
4		319.9370	43.56	-12.54	31.02	47.00	-15.98	QP
5		432.5457	38.82	-10.20	28.62	47.00	-18.38	QP
6		706.6999	35.96	-5.61	30.35	47.00	-16.65	QP

Temperature:	26 °C	Relative Humidity:	54%
Pressure:	101KPa	Phase :	Vertical
Test Voltage :	DC 12V	Test Mode:	Working

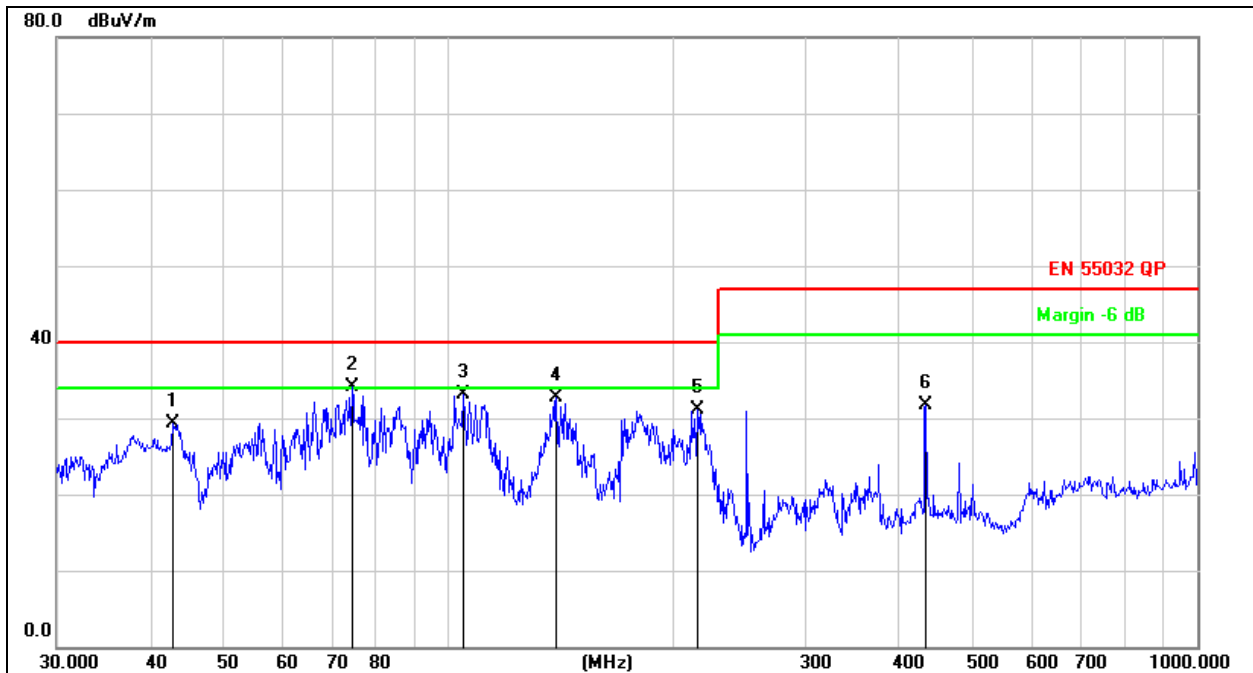
**Remark:**

1. Factor = Antenna Factor + Cable Loss – Pre-amplifier.
2. Measurement = Reading Level + Correct Factor
3. Over = Measurement - Limit

No.	Mk.	Freq. MHz	Reading Level dBuV	Correct Factor dB	Measure- ment dBuV/m	Limit dB/m	Over dB	Detector
1		42.8998	43.77	-14.48	29.29	40.00	-10.71	QP
2	*	74.3955	52.82	-18.77	34.05	40.00	-5.95	QP
3		104.5361	49.26	-16.25	33.01	40.00	-6.99	QP
4		139.3613	51.31	-18.69	32.62	40.00	-7.38	QP
5		215.2678	46.44	-15.28	31.16	40.00	-8.84	QP
6		434.0651	41.85	-10.17	31.68	47.00	-15.32	QP

## 8. Immunity Test Of General The Performance Criteria

Product Standard	EN 55035:2017+A11:2020 clause 8
<b>CRITERION A</b>	<p>The equipment shall continue to operate as intended without operator intervention. No degradation of performance, loss of function or change of operating state is allowed below a performance level specified by the manufacturer when the equipment is used as intended. The performance level may be replaced by a permissible loss of performance. If the minimum performance level or the permissible performance loss is not specified by the manufacturer, then either of these may be derived from the product description and documentation, and by what the user may reasonably expect from the equipment if used as intended.</p>
<b>CRITERION B</b>	<p>During the application of the disturbance, degradation of performance is allowed. However, no unintended change of actual operating state or stored data is allowed to persist after the test.</p> <p>After the test, the equipment shall continue to operate as intended without operator intervention; no degradation of performance or loss of function is allowed, below a performance level specified by the manufacturer, when the equipment is used as intended. The performance level may be replaced by a permissible loss of performance.</p> <p>If the minimum performance level (or the permissible performance loss), or recovery time, is not specified by the manufacturer, then either of these may be derived from the product description and documentation, and by what the user may reasonably expect from the equipment if used as intended.</p>
<b>CRITERION C</b>	<p>Loss of function is allowed, provided the function is self-recoverable, or can be restored by the operation of the controls by the user in accordance with the manufacturer's instructions. A reboot or re-start operation is allowed.</p> <p>Information stored in non-volatile memory, or protected by a battery backup, shall not be lost.</p>

## 9. Electrostatic Discharge (ESD)

### 9.1 Test Specification

<b>Basic standard</b>	: IEC 61000-4-2
<b>Test Port</b>	: Enclosure port
<b>Discharge Impedance</b>	: 330 ohm / 150 pF
<b>Discharge Mode</b>	: Single Discharge
<b>Discharge Period</b>	: one second between each discharge

### 9.2 Block Diagram of Test Setup

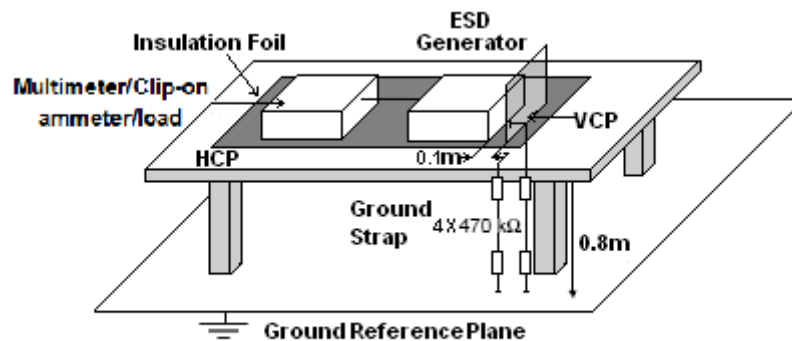

### 9.3 Test Procedure

- Electrostatic discharges were applied only to those points and surfaces of the Product that are accessible to users during normal operation.
- The test was performed with at least ten single discharges on the pre-selected points in the most sensitive polarity.
- The time interval between two successive single discharges was at least 1 second.
- The ESD generator was held perpendicularly to the surface to which the discharge was applied and the return cable was at least 0.2 meters from the Product.
- Contact discharges were applied to the non-insulating coating, with the pointed tip of the generator penetrating the coating and contacting the conducting substrate.
- Air discharges were applied with the round discharge tip of the discharge electrode approaching the Product as fast as possible (without causing mechanical damage) to touch the Product. After each discharge, the ESD generator was removed from the Product and re-triggered for a new single discharge. The test was repeated until all discharges were complete.
- At least ten single discharges (in the most sensitive polarity) were applied to the Horizontal Coupling Plane at points on each side of the Product. The ESD generator was positioned vertically at a distance of 0.1 meters from the Product with the discharge electrode touching the HCP.
- At least ten single discharges (in the most sensitive polarity) were applied to the center of one vertical edge of the Vertical Coupling Plane in sufficiently different positions that the four faces of the Product were completely illuminated. The VCP (dimensions 0.5m x 0.5m) was placed vertically to and 0.1 meters from the Product.

## 9.4 Test Results

Temperature:	26 °C	Relative Humidity:	54%
Pressure:	101kPa	Test Mode:	Working
Test Voltage :	DC 12V		

Discharge Method	Discharge Position	Voltage (±kV)	Min. No. of Discharge per polarity (Each Point)	Required Level	Performance Criterion
Contact Discharge	Conductive Surfaces	4	10	B	A
	Indirect Discharge HCP	4	10	B	A
	Indirect Discharge VCP	4	10	B	A
Air Discharge	Slots, Apertures, and Insulating Surfaces	8	10	B	A

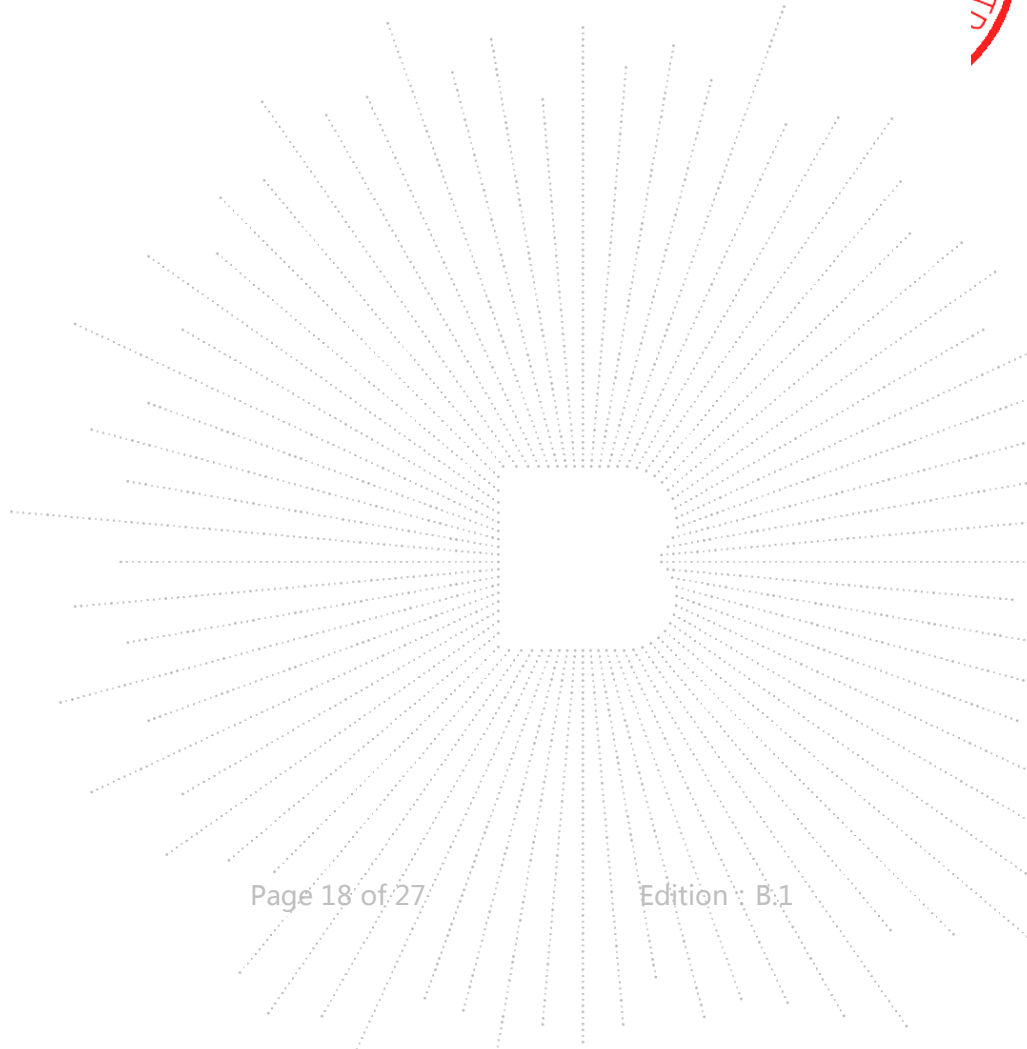
## 10. Continuous Rf Electromagnetic Field Disturbances (RS)

### 10.1 Test Specification

<b>Basic standard</b>	: IEC 61000-4-3
<b>Test Port</b>	: Enclosure port
<b>Step Size</b>	: 1%
<b>Modulation</b>	: 1kHz, 80% AM
<b>Dwell Time</b>	: 1 second
<b>Polarization</b>	: Horizontal & Vertical

### 10.2 Block Diagram of Test Setup

Below 1GHz:

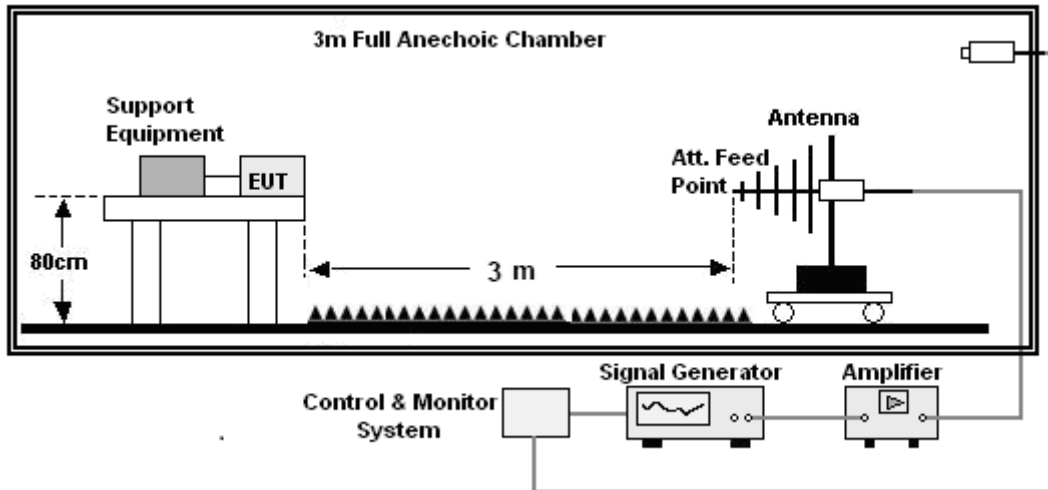

### 10.3 Test Procedure

- The testing was performed in a fully-anechoic chamber. The transmit antenna was located at a distance of 3 meters from the Product.
- The frequency range is swept from 80MHz to 1000MHz, 1800MHz, 2600MHz, 3500MHz, 5000MHz, with the signal 80% amplitude modulated with a 1 kHz sine wave, and the step size was 1%.
- The dwell time at each frequency shall not be less than the time necessary for the EUT to be exercised and to be able to respond, but should not exceed 5 s at each of the frequencies during the scan.
- The test was performed with the Product exposed to both vertically and horizontally polarized fields on each of the four sides.
- For Broadcast reception function: Group 2 not apply in this test.

## 10.4 Test Results

Temperature:	26 °C	Relative Humidity:	54%
Pressure:	101kPa	Test Mode:	Working
Test Voltage :	DC 12V		

Frequency	Position	Field Strength (V/m)	Required Level	Performance Criterion
80 - 1000MHz, 1800MHz, 2600MHz, 3500MHz, 5000MHz	Front, Right, Back, Left	3	A	A

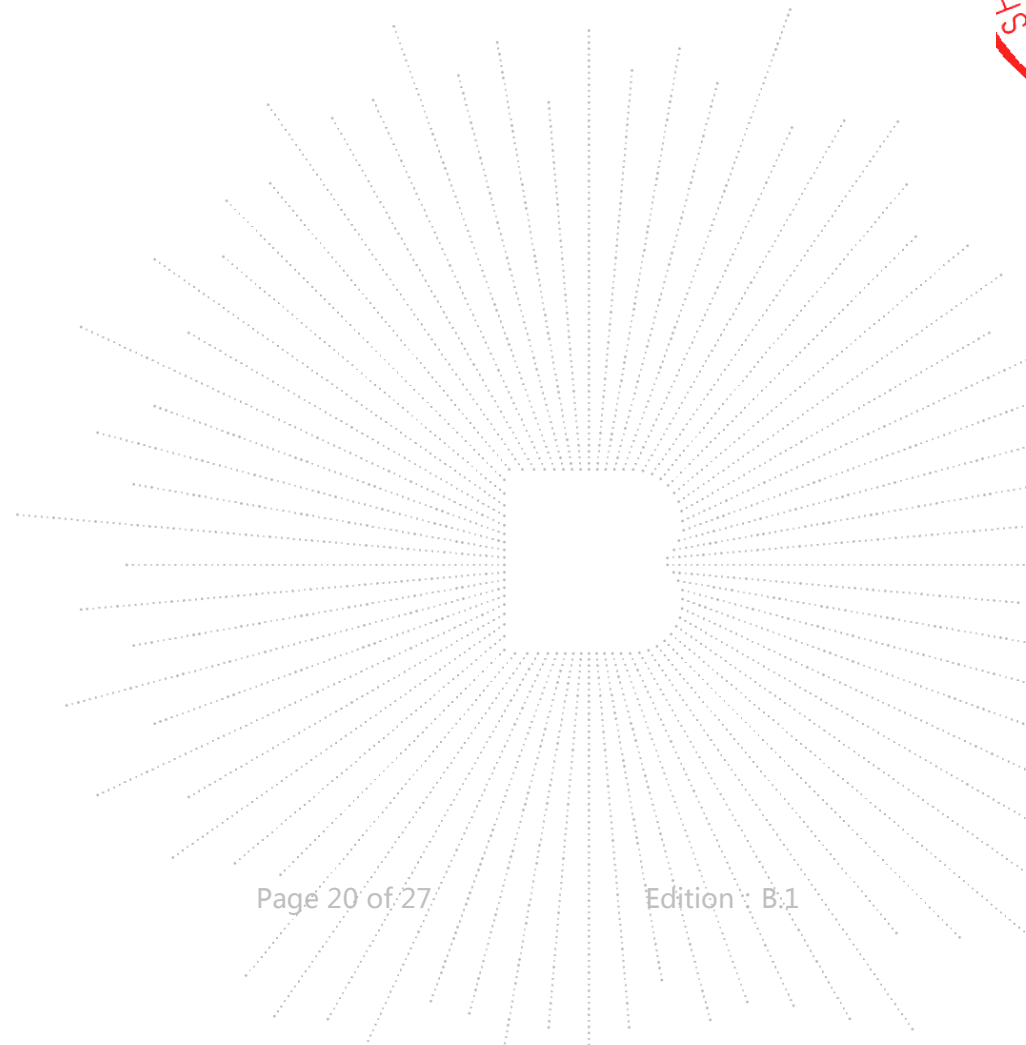

### 11. EUT Photographs

EUT Photo 1



EUT Photo 2



EUT Photo 3

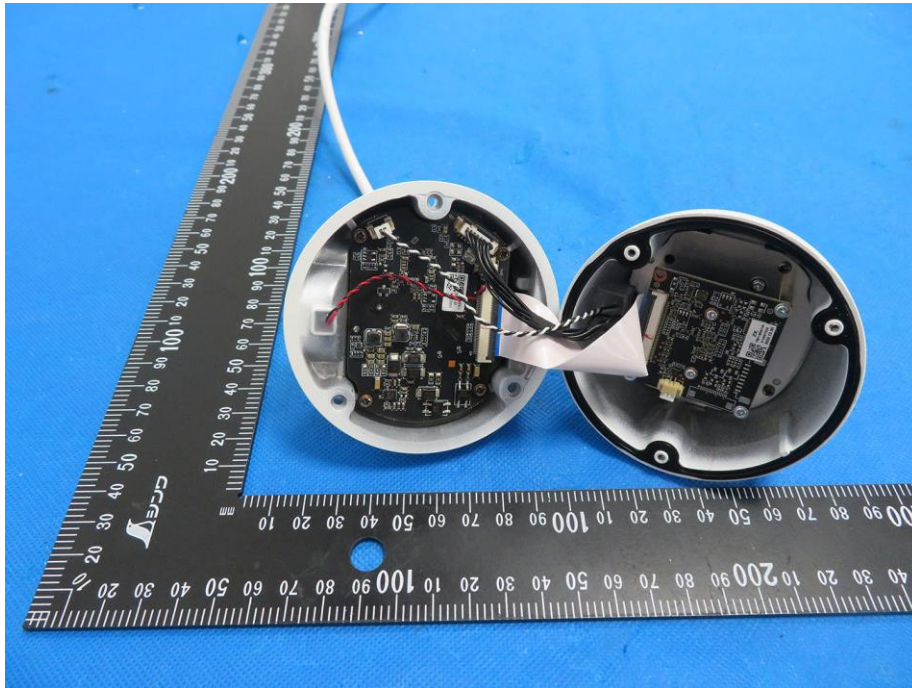

EUT Photo 4

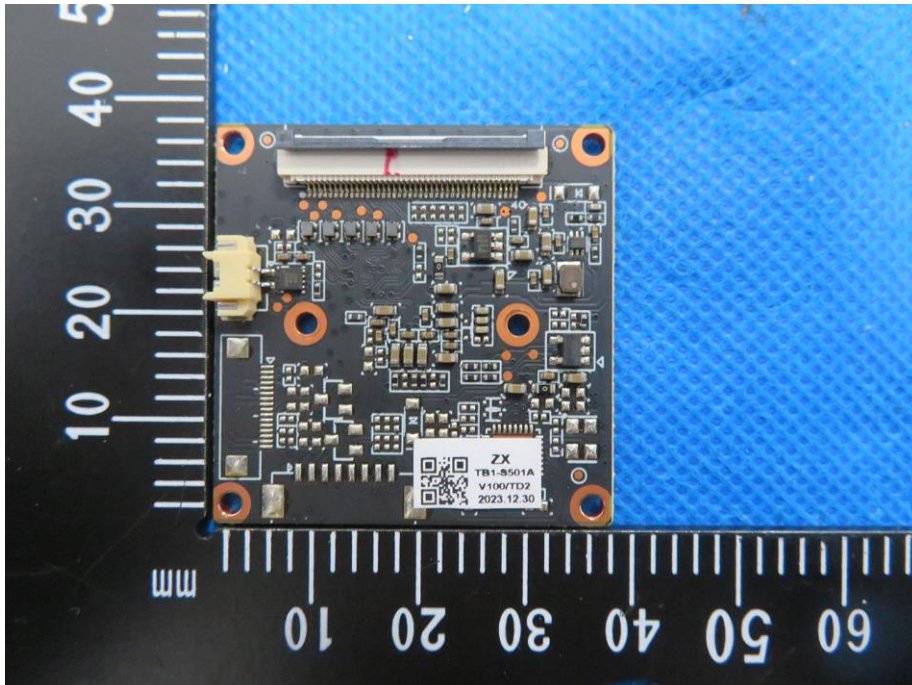

EUT Photo 5

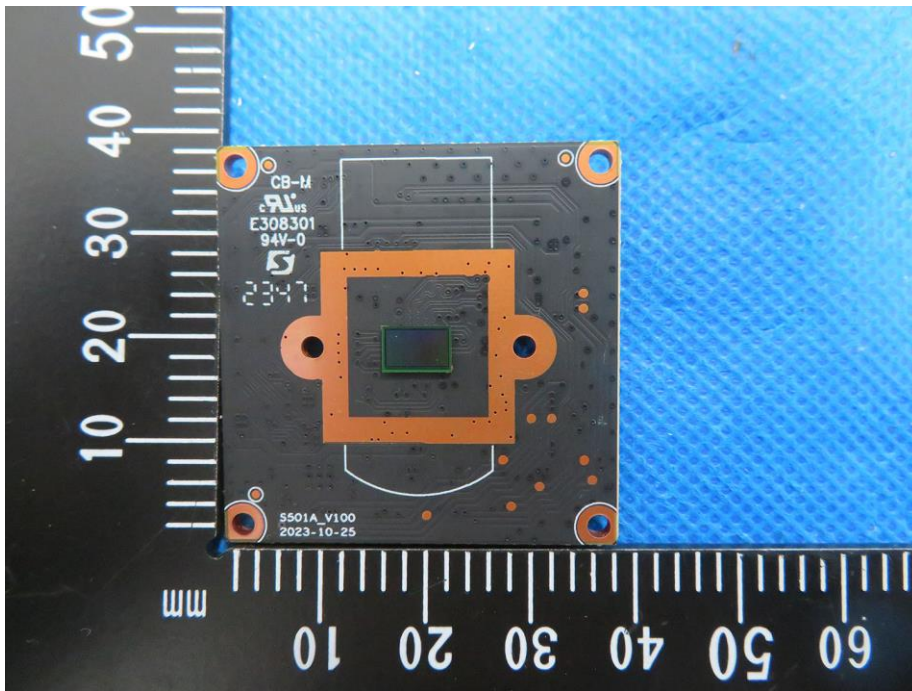

EUT Photo 6

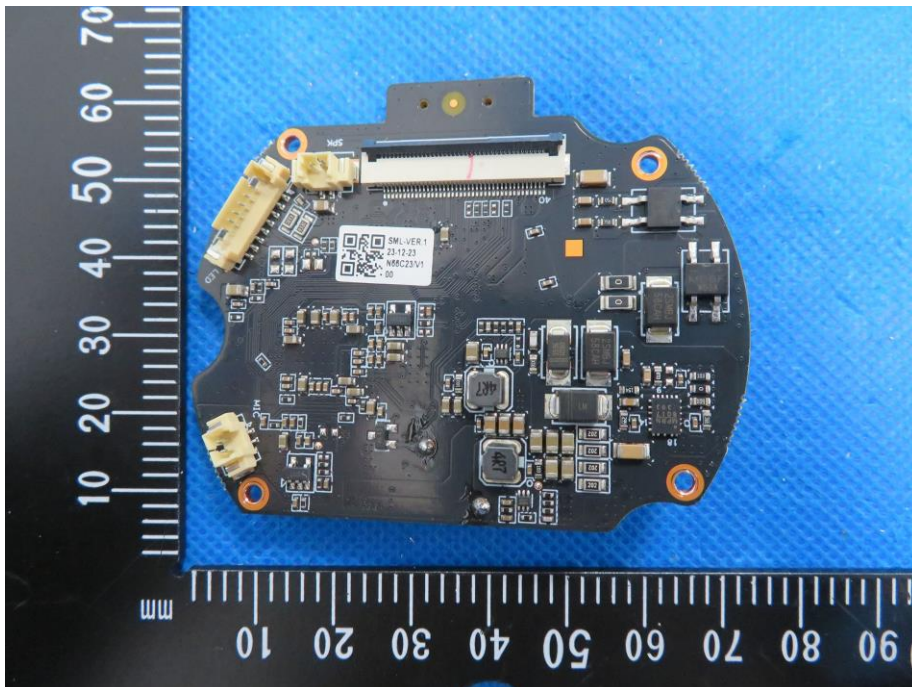

EUT Photo 7

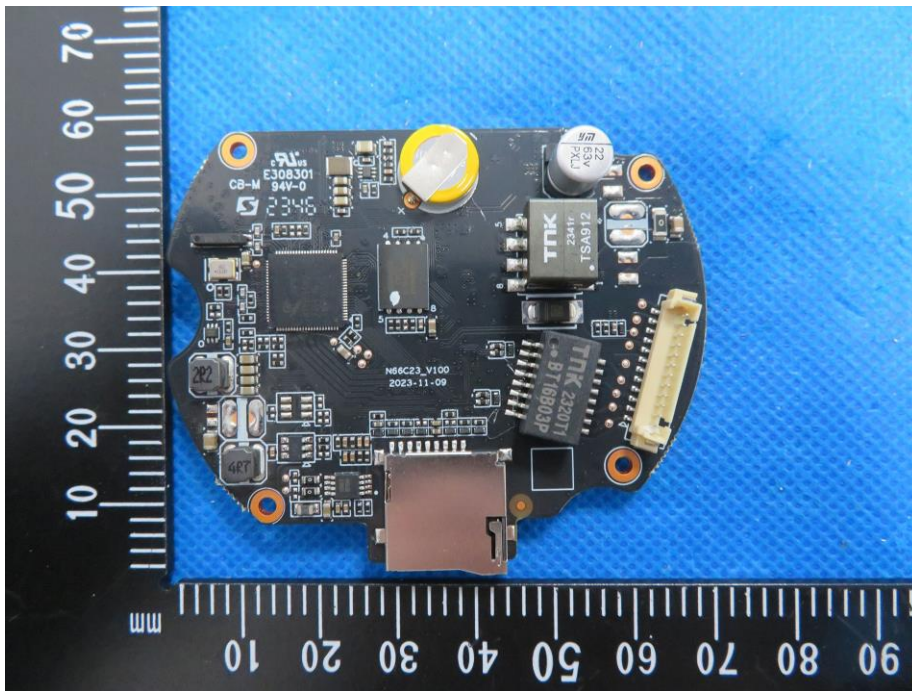

## 12. EUT Test Setup Photographs

Radiated emissions

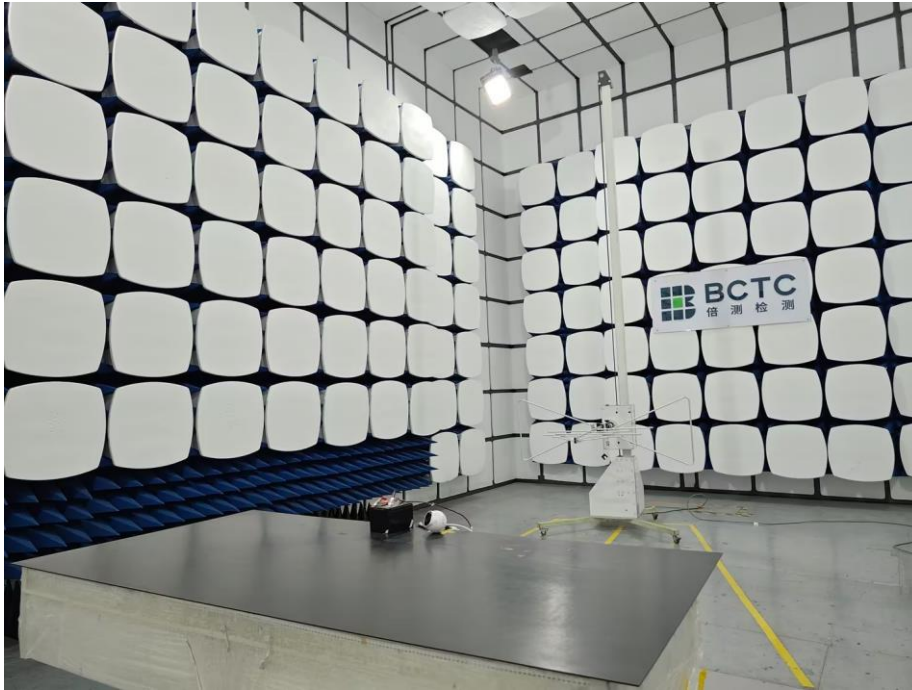

ESD



RS

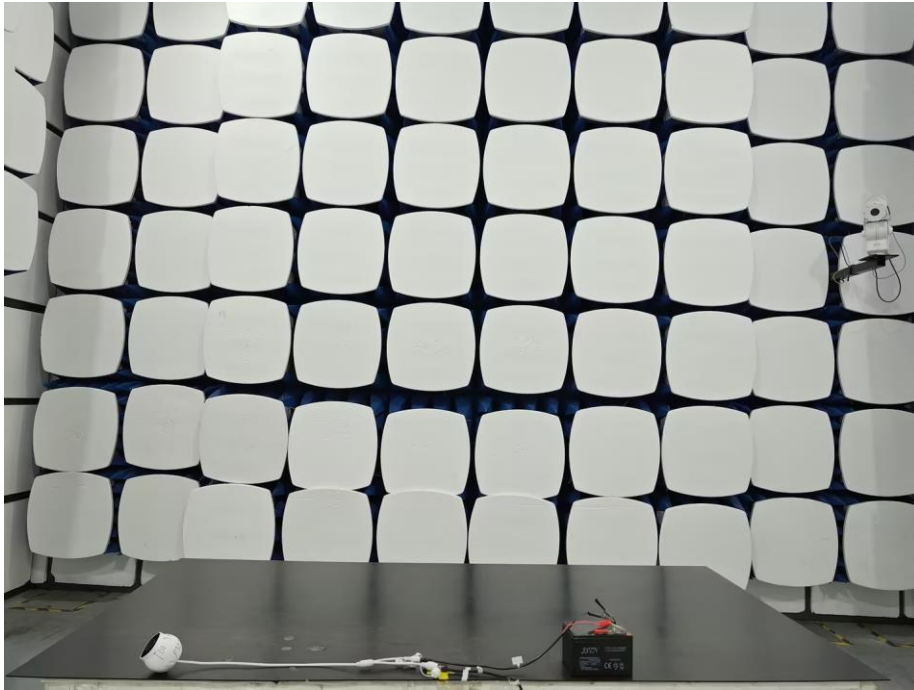

TELE



**STATEMENT**

1. The equipment lists are traceable to the national reference standards.
2. The test report can not be partially copied unless prior written approval is issued from our lab.
3. The test report is invalid without the "special seal for inspection and testing".
4. The test report is invalid without the signature of the approver.
5. The test process and test result is only related to the Unit Under Test.
6. Sample information is provided by the client and the laboratory is not responsible for its authenticity.
7. The quality system of our laboratory is in accordance with ISO/IEC17025.
8. If there is any objection to this test report, the client should inform issuing laboratory within 15 days from the date of receiving test report.

## Address:

1-2/F., Building B, Pengzhou Industrial Park, No.158, Fuyuan 1st Road, Zhancheng, Fuhai Subdistrict, Bao'an District, Shenzhen, Guangdong, China

TEL: 400-788-9558

P.C.: 518103

FAX: 0755-33229357

Website: <http://www.chnbctc.com>E-Mail: [bctc@bctc-lab.com.cn](mailto:bctc@bctc-lab.com.cn)

※※※※※ END ※※※※※