



中国认可  
国际互认  
检测  
TESTING  
CNAS L6791

# TEST REPORT

**Applicant:** REOLINK INNOVATION LIMITED

**Address:** FLAT/RM 705 7/F FA YUEN COMMERCIAL BUILDING 75-77 FA YUEN STREET MONG KOK KL HONG KONG

**Equipment Type:** WiFi IP Camera

**Model Name:** Reolink Argus 3 Pro (refer to section 2.3)

**Brand Name:** Reolink

**Test Standard:** ETSI EN 301 489-1 V2.2.3 (2019-11)  
ETSI EN 301 489-3 V2.3.2 (2023-01)  
ETSI EN 301 489-17 V3.3.1 (2024-09)

**Sample Arrival Date:** Nov. 20, 2025

**Test Date:** Nov. 21, 2025 - Dec. 03, 2025

**Date of Issue:** Dec. 30, 2025

**ISSUED BY:**

Shenzhen BALUN Technology Co., Ltd.

**Tested by:** Xiao Tangqi

**Checked by:** Xiong Chong

**Approved by:** Tolan Tu  
(Testing Director)

*Xiao Tangqi*

*Xiong Chong*

*Tolan Tu*

### Revision History

Version	Issue Date	Revisions Content
<u>Rev. 01</u>	<u>Dec. 30, 2025</u>	<u>Initial Issue</u>

## TABLE OF CONTENTS

1	GENERAL INFORMATION.....	4
1.1	Test Laboratory .....	4
1.2	Test Location .....	4
2	PRODUCT INFORMATION .....	5
2.1	Applicant Information .....	5
2.2	Manufacturer Information .....	5
2.3	General Description for Equipment under Test (EUT) .....	5
2.4	Ancillary Equipment .....	5
2.5	Technical Information .....	5
3	SUMMARY OF TEST RESULTS .....	7
3.1	Test Standards .....	7
3.2	Referenced Standards .....	8
3.3	Verdict .....	9
3.4	Test Uncertainty .....	10
4	GENERAL TEST CONFIGURATIONS .....	11
4.1	Test Enclosure List .....	11
4.2	Test Configurations.....	12
4.3	Test Setups .....	13
5	TEST ITEMS .....	20
5.1	Emission Tests .....	20
5.2	Immunity Tests .....	28
ANNEX A TEST RESULTS.....		40
A.1	Radiated Emission.....	40
A.2	Conducted Emissions .....	46
A.3	Harmonic Current Emissions .....	49

---

A.4	Voltage Fluctuations & Flicker .....	50
A.5	Electrostatic Discharge .....	51
A.6	Radio Frequency Electromagnetic Field .....	54
A.7	Fast Transients Common Mode.....	56
A.8	Transients and Surges.....	57
A.9	Surges.....	58
A.10	Radio Frequency Common Mode.....	59
A.11	Voltage Dips and Interruptions .....	60
ANNEX B	TEST SETUP PHOTOS .....	61
ANNEX C	EUT EXTERNAL PHOTOS.....	61
ANNEX D	EUT INTERNAL PHOTOS.....	61

# 1 GENERAL INFORMATION

## 1.1 Test Laboratory

Name	Shenzhen BALUN Technology Co., Ltd.
Address	Block B, 1/F, Baisha Science and Technology Park, Shahe Xi Road, Nanshan District, Shenzhen, Guangdong Province, P. R. China
Phone Number	+86 755 6685 0100

## 1.2 Test Location

Name	Shenzhen BALUN Technology Co., Ltd.
Location	<input type="checkbox"/> Block B, 1/F, Baisha Science and Technology Park, Shahe Xi Road, Nanshan District, Shenzhen, Guangdong Province, P. R. China
	<input type="checkbox"/> 1/F, Building B, Ganghongji High-tech Intelligent Industrial Park, No. 1008, Songbai Road, Yangguang Community, Xili Sub-district, Nanshan District, Shenzhen, Guangdong Province, P. R. China
	<input checked="" type="checkbox"/> Building 2, Intelligent Connected Vehicle Industrial Park, No. 55, Xiangshan Road, Luotian Community, Yanluo Sub-district, Bao'an District, Shenzhen

## 2 PRODUCT INFORMATION

### 2.1 Applicant Information

Applicant	REOLINK INNOVATION LIMITED
Address	FLAT/RM 705 7/F FA YUEN COMMERCIAL BUILDING 75-77 FA YUEN STREET MONG KOK KL HONG KONG

### 2.2 Manufacturer Information

Manufacturer	REOLINK INNOVATION LIMITED
Address	FLAT/RM 705 7/F FA YUEN COMMERCIAL BUILDING 75-77 FA YUEN STREET MONG KOK KL HONG KONG

### 2.3 General Description for Equipment under Test (EUT)

EUT Name	WiFi IP Camera
Model Name Under Test	Reolink Argus 3 Pro
Series Model Name	Argus Series B330
Description of Model name differentiation	All models are same with electrical parameters and internal circuit structure, but only differ in model name. (this information provided by the applicant)
Hardware Version	N/A
Software Version	N/A
Dimensions (Approx.)	N/A
Weight (Approx.)	N/A

### 2.4 Ancillary Equipment

Ancillary Equipment 1	Battery	
	Brand Name	N/A
	Model No.	C13V1
	Serial No.	N/A
	Capacity	5000 mAh
	Rated Voltage	3.6 V
	Limit Charge Voltage	4.2 V

## 2.5 Technical Information

Network and Wireless connectivity		Bluetooth, WIFI, 5.8G SRD
Interfaces present on the EUT	AC Ports	No AC Ports.
	DC Ports	From power supply to EUT, the DC port cable length is less than 3m.
	Signal/Control Ports	Type-C, SD, which cable length is less than 3m.
	Wired Network Ports	No Wired Network Ports.
Interfaces present on the Adapter	Input Ports	From mains to AC power adapter.
	Output Ports	From power supply to EUT, the DC output port cable length is less than 3m.
Classification of equipment		Class B

### 3 SUMMARY OF TEST RESULTS

#### 3.1 Test Standards

The objective of the report is to perform testing according to following standards for CE marking:

No.	Identity	Document Title
1	ETSI EN 301 489-1 V2.2.3 (2019-11)	ElectroMagnetic Compatibility (EMC) standard for radio equipment and services; Part 1: Common technical requirements; Harmonised Standard for ElectroMagnetic Compatibility
2	ETSI EN 301 489-3 V2.3.2 (2023-01)	ElectroMagnetic Compatibility (EMC) standard for radio equipment and services; Part 3: Specific conditions for Short Range Devices (SRD) operating on frequencies between 9 kHz and 246 GHz; Harmonised Standard for ElectroMagnetic Compatibility
3	ETSI EN 301 489-17 V3.3.1 (2024-09)	ElectroMagnetic Compatibility (EMC) standard for radio equipment and services; Part 17: Specific conditions for Broadband and Wideband Data Transmission Systems; Harmonised Standard for ElectroMagnetic Compatibility

### 3.2 Referenced Standards

The following referenced standards are necessary for the report.

No.	Identity	Document Title
1	CENELEC EN 55032 (2015)	Electromagnetic compatibility of multimedia equipment - Emission Requirements.
2	CENELEC EN 61000-3-2 (2014)	Electromagnetic compatibility (EMC) - Part 3-2: Limits - Limits for harmonic current emissions (equipment input current $\leq 16$ A per phase)
3	CENELEC EN 61000-3-3 (2013)	Electromagnetic compatibility (EMC) - Part 3-3: Limits - Limitation of voltage changes, voltage fluctuations and flicker in public low-voltage supply systems, for equipment with rated current $\leq 16$ A per phase and not subject to conditional connection.
4	CENELEC EN 61000-4-2 (2009)	Electromagnetic compatibility (EMC) - Part 4-2: Testing and measurement techniques - Electrostatic discharge immunity test.
5	CENELEC EN 61000-4-3 (2006), A1 (2008) and A2 (2010)	Electromagnetic compatibility (EMC) - Part 4-3: Testing and measurement techniques - Radiated, radio-frequency, electromagnetic field immunity test.
6	CENELEC EN 61000-4-4 (2012)	Electromagnetic compatibility (EMC) - Part 4-4: Testing and measurement techniques - Electrical fast transient/burst immunity test.
7	CENELEC EN 61000-4-5 (2014): + A1 (2017)	Electromagnetic compatibility (EMC) - Part 4-5: Testing and measurement techniques - Surge immunity test.
8	CENELEC EN 61000-4-6 (2014)	Electromagnetic compatibility (EMC) - Part 4-6: Testing and measurement techniques - Immunity to conducted disturbances, induced by radio-frequency fields.
9	CENELEC EN 61000-4-11 (2004)	Electromagnetic compatibility (EMC) - Part 4-11: Testing and measurement techniques - Voltage dips, short interruptions and voltage variations immunity tests.
10	ISO 7637-2 (2004)	Road vehicles - Electrical disturbances from conduction and coupling - Part 2: Electrical transient conduction along supply lines only.

### 3.3 Verdict

No.	Base Standard	Description		Test Verdict	Remark
Emission					
1	EN 55032	Radiated Emission	Below 1 GHz	Pass	--
			Above 1 GHz	Pass	Note 1
2	EN 55032	Conducted Emission	AC Mains Ports	Pass	--
			DC Power Ports	N/A	Note 2
			Wired Network Ports	N/A	Note 7
3	EN 61000-3-2	Harmonic Current Emissions		N/A	Note 3
4	EN 61000-3-3	Voltage Fluctuations & Flicker		Pass	--
Immunity					
5	EN 61000-4-2	Electrostatic Discharge		Pass	--
6	EN 61000-4-3	Radio Frequency Electromagnetic Field		Pass	--
7	EN 61000-4-4	Fast Transients Common Mode	AC Ports	Pass	--
			DC Ports	N/A	Note 4
			Signal Ports, Control Ports	N/A	Note 5
			Wired Network Ports	N/A	Note 7
8	ISO 7637-2	Transients and Surges		N/A	Note 6
9	EN 61000-4-5	Surges	AC Ports	Pass	--
			Wired Network Ports	N/A	--
10	EN 61000-4-6	Radio Frequency Common Mode	AC Ports	Pass	--
			DC Ports	N/A	Note 4
			Signal Ports, Control Ports	N/A	Note 5
			Wired Network Ports	N/A	Note 7
11	EN 61000-4-11	Voltage Dips and Interruptions		Pass	--
<p>Note 1: The highest frequency of the internal sources of the EUT is above 108 MHz, the measurement shall be made above 1 GHz.</p> <p>Note 2: Only applicable for equipment has DC power input and/or output ports with a cable length greater than 3 m or from a vehicle power supply.</p> <p>Note 3: There is no need for Harmonics test to be performed on this product (rated power is less than 75 W) in accordance with EN 61000-3-2.</p> <p>For further details, please refer to Clause 7 of EN 61000-3-2 which states:            "For the following categories of equipment, limits are not specified in this edition of the standard:            - equipment with a rated power of 75 W or less, other than lighting equipment."</p> <p>Note 4: Only applicable for equipment with DC power ports with cables longer than 3 m.</p> <p>Note 5: Only applicable for equipment with cable(s) longer than 3 m connected to signal or control ports.</p> <p>Note 6: Only applicable for equipment is connected to vehicle power supply.</p> <p>Note 7: The EUT has no Wired Network Ports, so this test item is not applicable.</p> <p>The standard versions involved in this table are the same as those in Sections 3.2.</p>					

### 3.4 Test Uncertainty

The following measurement uncertainty levels have been estimated for tests performed on the EUT as specified in CISPR 16-4-2. This uncertainty represents an expanded uncertainty expressed at approximately the 95% confidence level using a coverage factor of  $k=2$ .

Measurement	Value
Conducted emissions (9 kHz-30 MHz)-AMN	3.2 dB
Radiated emissions (30 MHz-1 GHz)-966#5	4.7 dB
Radiated emissions (1 GHz-18 GHz)-966#5	5.0 dB

## 4 GENERAL TEST CONFIGURATIONS

### 4.1 Test Enclosure List

Description	Manufacturer	Model	Serial No.	Length	Description	Use
Wireless Communications Test Set	R&S	CMW500	127801	2026.11.25	2026.11.24	<input checked="" type="checkbox"/>
Adapter	OPPO	AK903HK	N/A	N/A	N/A	<input checked="" type="checkbox"/>
Adapter	XIAOMI	AD100G	N/A	N/A	N/A	<input checked="" type="checkbox"/>
Laptop	Lenovo	ZHAOYANG K43c-80	N/A	N/A	N/A	<input checked="" type="checkbox"/>
USB Cable	OPPO	N/A	N/A	1m	N/A	<input checked="" type="checkbox"/>
Router	HUAWEI	WS7000 V2	RT-HW-002	N/A	N/A	<input checked="" type="checkbox"/>
SD Card	Kingston	SDCS2/32GB SPCN	A9	N/A	N/A	<input checked="" type="checkbox"/>

## 4.2 Test Configurations

All test modes of EUT are listed in the table below.

Test Mode Configuration	Description
Mode 1	<u>The 2.4G WIFI Test Mode</u> EUT + Battery + Adapter + USB Cable + SD Card + Route + Laptop + 2.4G WIFI Link + BT Link
Mode 2	<u>The 5G WIFI Test Mode</u> EUT + Battery + Adapter + USB Cable + SD Card + Route + Laptop + 5G WIFI Link + BT Link
Mode 3	<u>The 5.8G SRD Test Mode</u> EUT + Battery + Adapter + USB Cable + SD Card + Route + Laptop + 5.8G SRD Link + BT Link

Test Case	Test Mode Configuration	Worst Mode
Radiated Emission	Mode 1~Mode 3	1
Conducted Emission	Mode 1~Mode 3	1
Voltage Fluctuations & Flicker	Mode 1~Mode 3	1
Electrostatic Discharge	Mode 1~Mode 3	1
Radio Frequency Electromagnetic Field	Mode 1~Mode 3	1
Fast Transients Common Mode	Mode 1~Mode 3	1
Surges	Mode 1~Mode 3	1
Radio Frequency Common Mode	Mode 1~Mode 3	1
Voltage Dips and Interruptions	Mode 1~Mode 3	1
Note: All operation modes were tested, but only test data of the worst mode was presented in this report.		

### 4.3 Test Setups

#### Test Setup 1

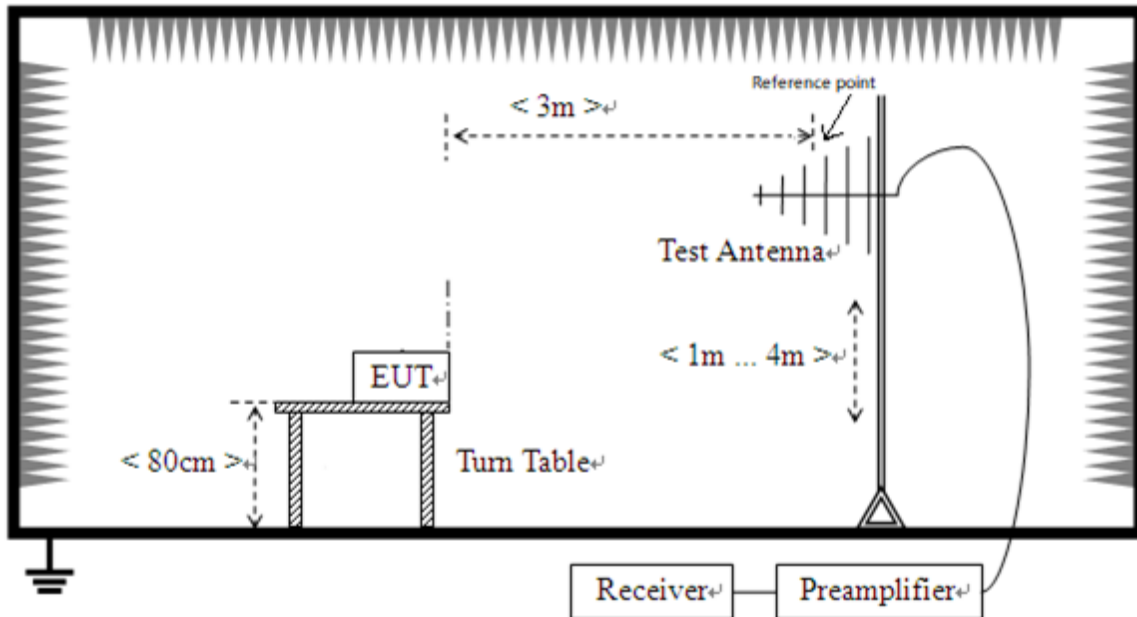

Radiated Emission (30 MHz-1 GHz)

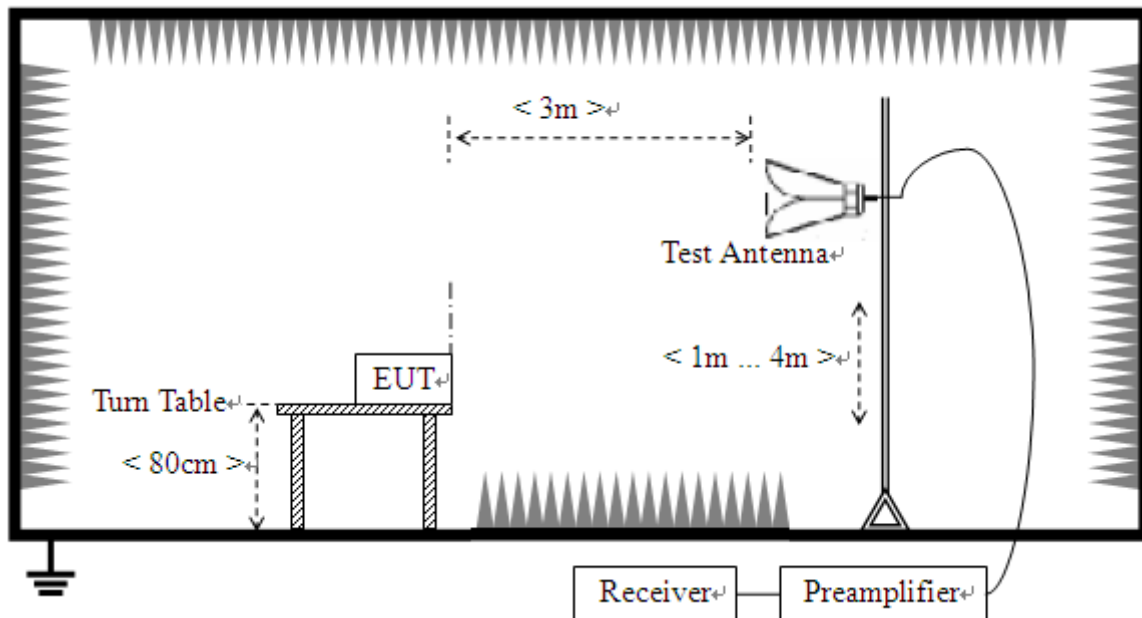

Radiated Emission (above 1 GHz)

Test Setup 2

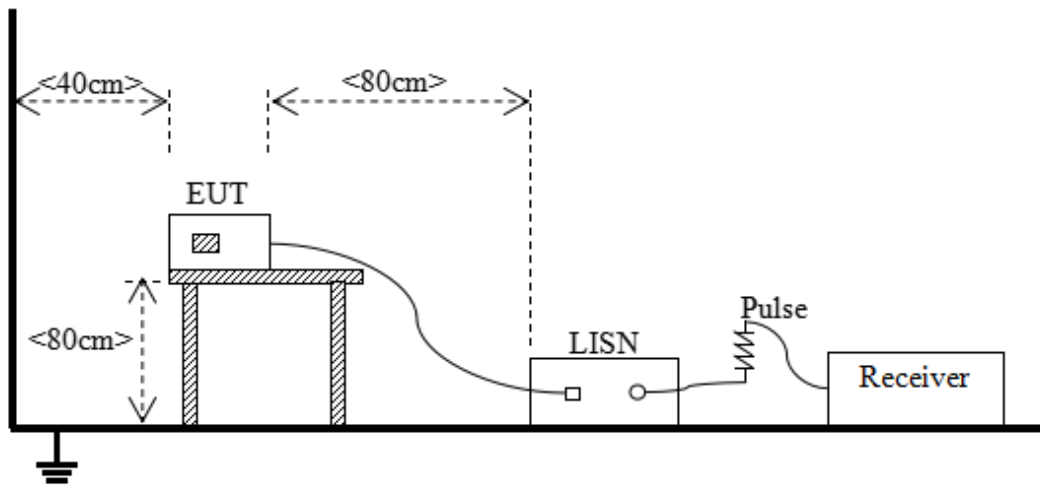

Conducted Emission for AC/DC Ports

Test Setup 3

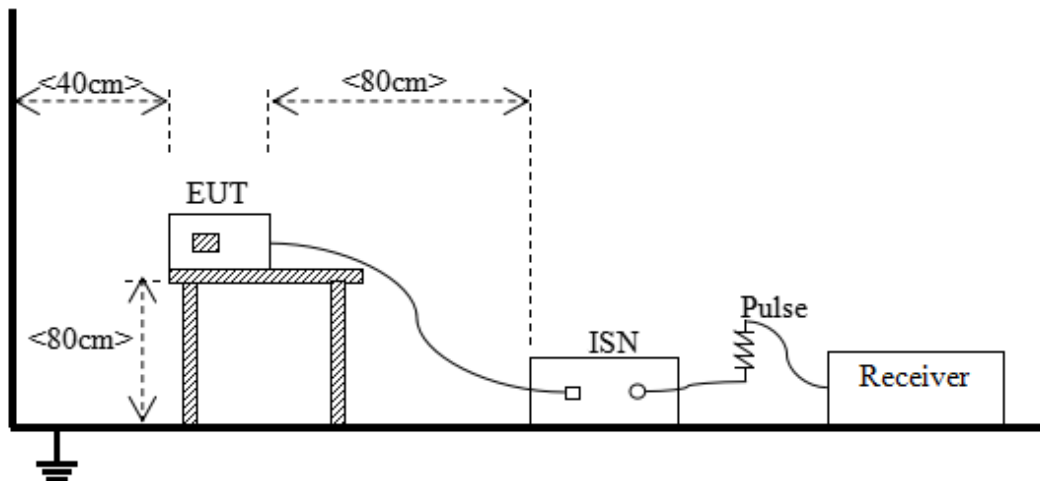

Conducted Emission for Wired Network Ports

Test Setup 4

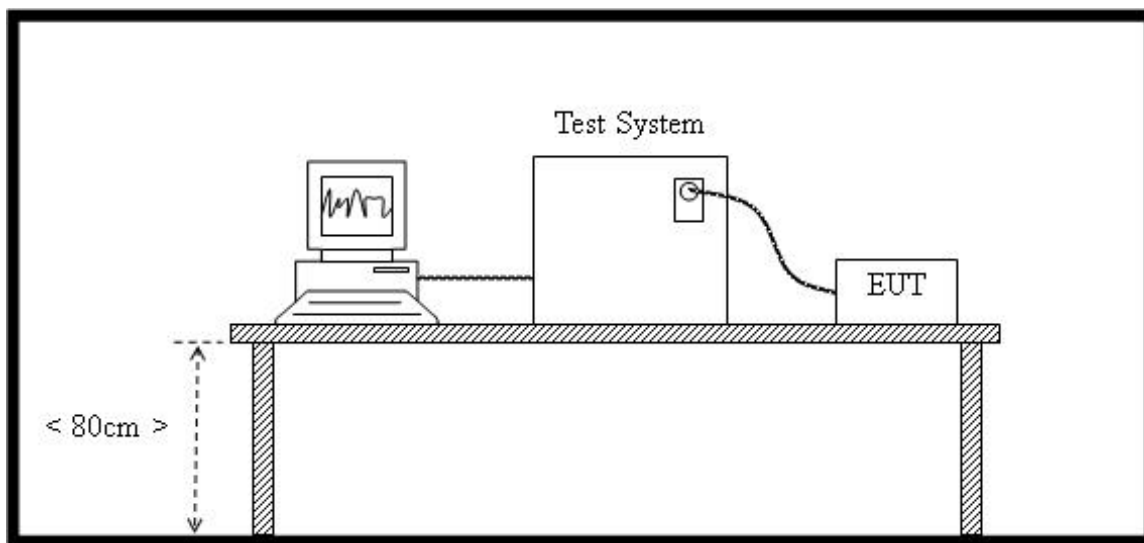

Harmonic Current Emissions

Test Setup 5

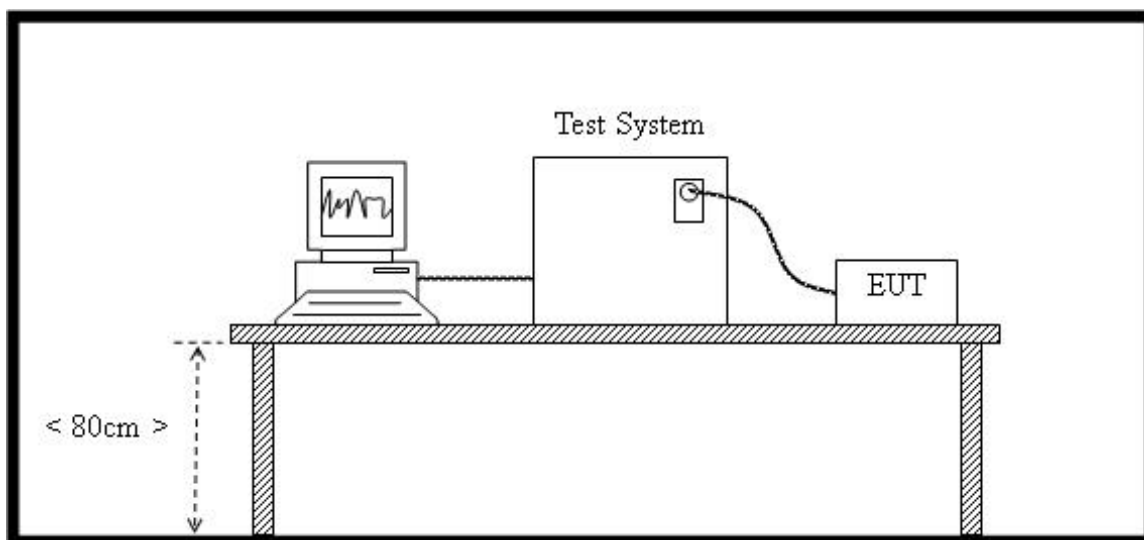

Voltage Fluctuations and Flicker

Test Setup 6

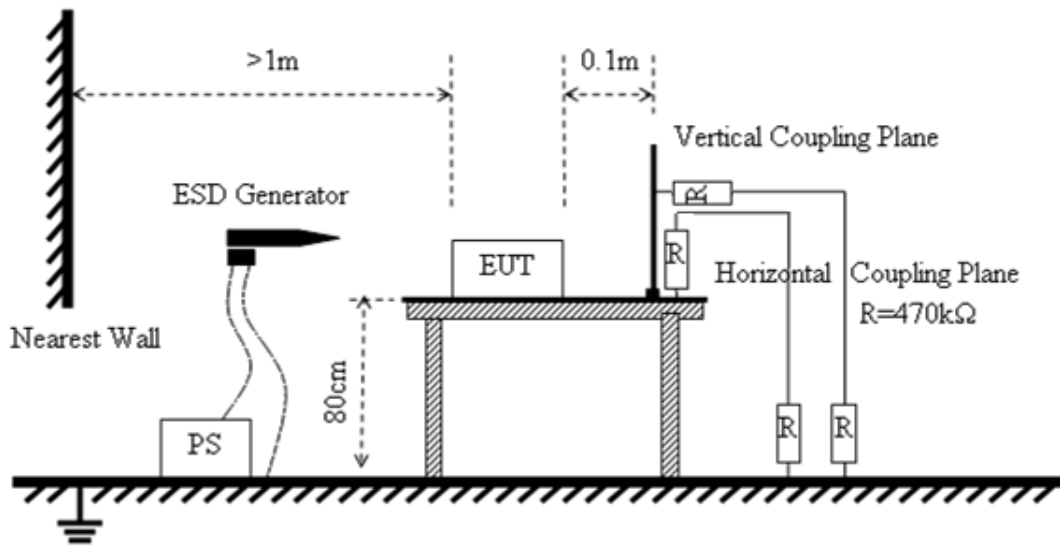

Electrostatic Discharge

Test Setup 7

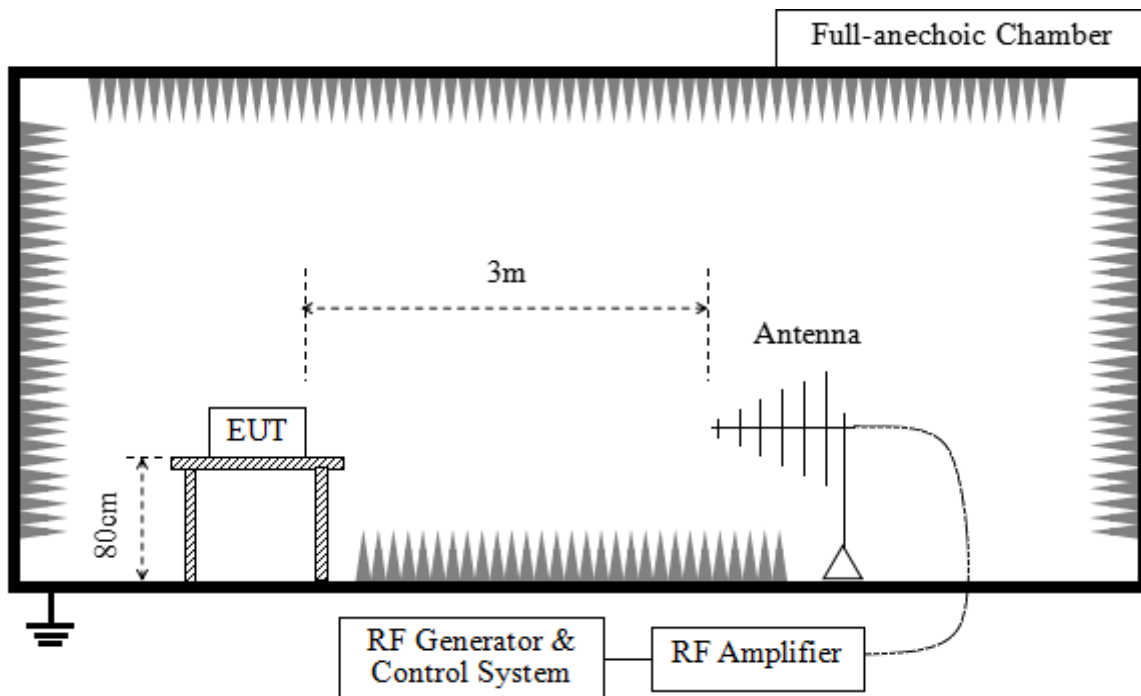

Radio Frequency Electromagnetic Field

Test Setup 8

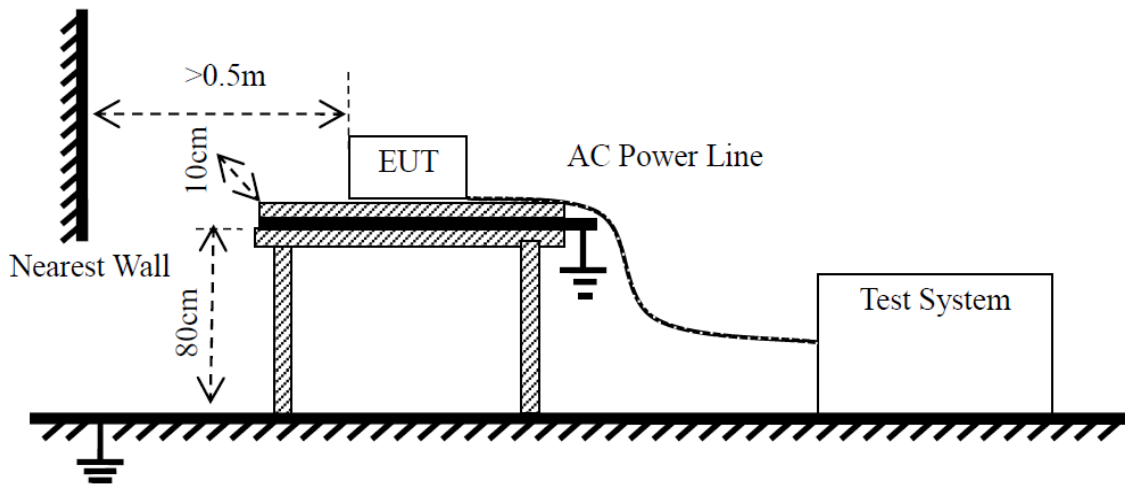

Fast Transients Common Mode

Test Setup 9

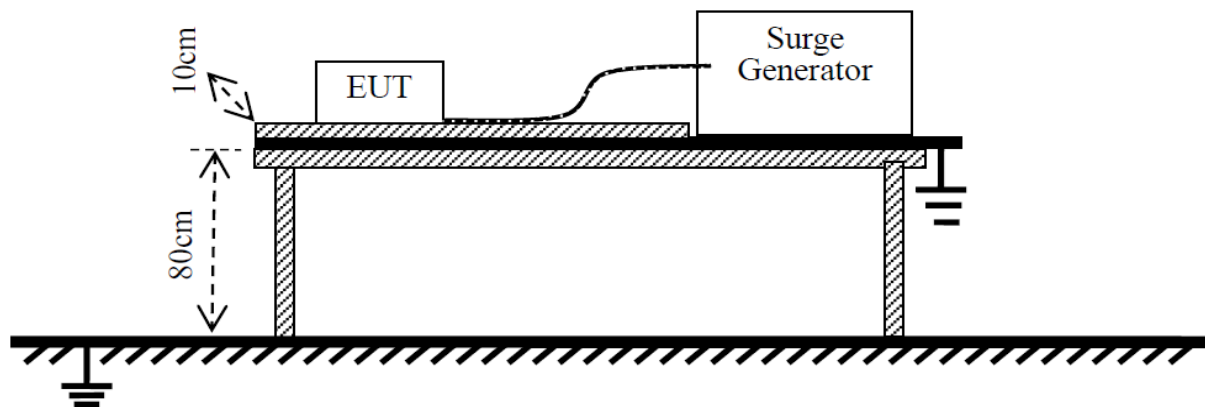

Transients and Surges

Test Setup 10

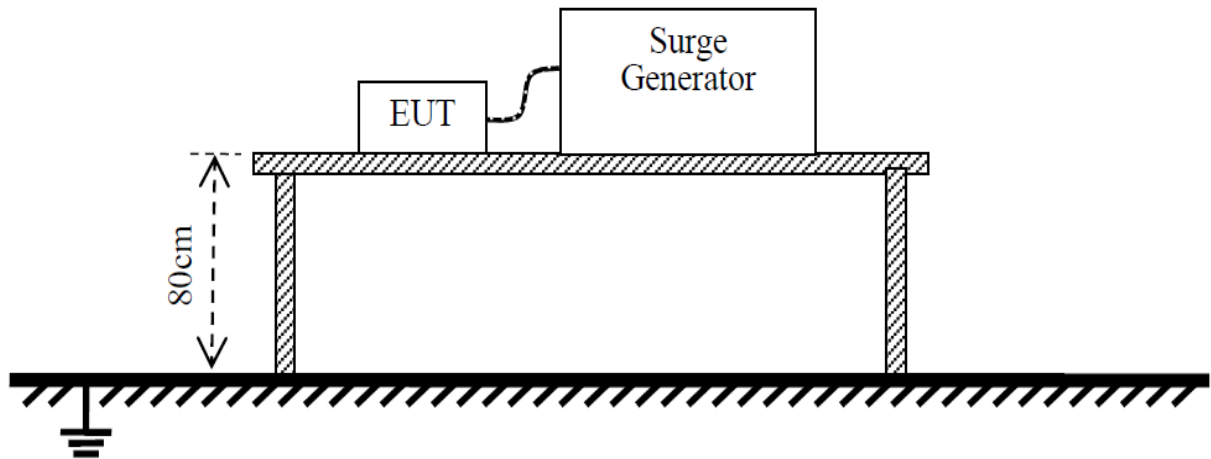

Surges

Test Setup 11

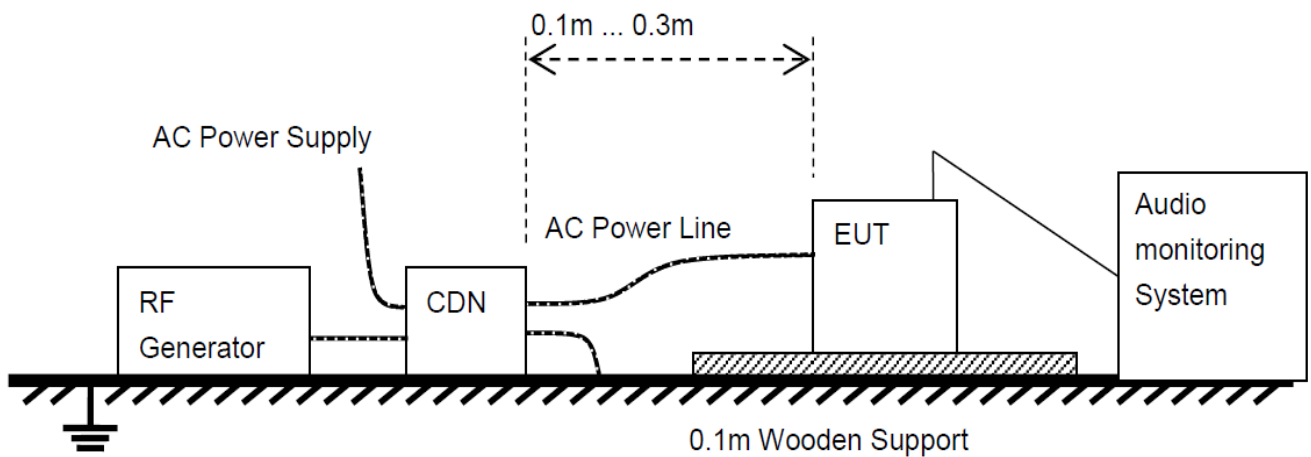

Radio Frequency Common Mode

Test Setup 12

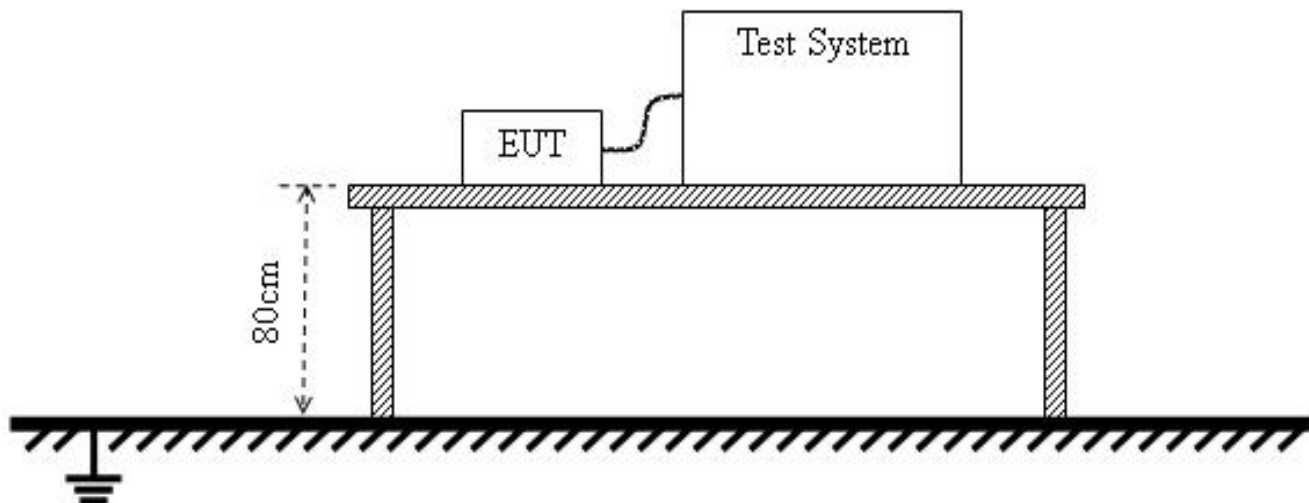

Voltage Dips and Interruptions

## 5 TEST ITEMS

### 5.1 Emission Tests

#### 5.1.1 Radiated Emission

##### 5.1.1.1 Limit

Frequency range (MHz)	Class A (at 3 m)		Class B (at 3 m)	
	Quasi-Peak Limit (dB $\mu$ V/m)		Quasi-Peak Limit (dB $\mu$ V/m)	
30 - 230	50		40	
230 - 1000	57		47	

Frequency range (MHz)	Class A (at 3 m)		Class B (at 3 m)	
	Peak Limit (dB $\mu$ V/m)	Average Limit (dB $\mu$ V/m)	Peak Limit (dB $\mu$ V/m)	Average Limit (dB $\mu$ V/m)
1000-3000	76	56	70	50
3000-6000	80	60	74	54

NOTE:

- 1) The lower limit shall apply at the transition frequency.
- 2) Additional provisions may be required for cases where interference occurs.

##### 5.1.1.2 Test Setup

Please refer to 4.3 section description of test setup of test setup 1. The photo of test setup please refer to ANNEX B.

##### 5.1.1.3 Test Procedure

An initial pre-scan was performed in the chamber using the EMI Receiver in peak detection mode. Quasi-peak measurements were conducted based on the peak sweep graph. The EUT was measured by antenna with 2 orthogonal polarities.

Use the following spectrum analyzer settings:

Span = wide enough to fully capture the emission being measured

RBW = 1 MHz for  $f \geq 1$  GHz, 100 kHz for  $f < 1$  GHz

VBW  $\geq$  RBW

Sweep = auto

Detector function = peak for  $f < 1$  GHz, peak & RMS Average for  $f \geq 1$  GHz

Trace = max hold

##### 5.1.1.4 Test Result and Test Equipment List

Please refer to ANNEX A.1.

## 5.1.2 Conducted Emission

### 5.1.2.1 Test Limit

#### AC Port

Frequency range (MHz)	Class A		Class B	
	Quasi-peak (dB $\mu$ V)	Average (dB $\mu$ V)	Quasi-peak (dB $\mu$ V)	Average (dB $\mu$ V)
0.15 - 0.50	79	66	66-56	56-46
0.50 - 5	73	60	56	46
5 - 30	73	60	60	50

#### DC Port

Frequency range (MHz)	Quasi-peak (dB $\mu$ V)	Average (dB $\mu$ V)
0.15 - 0.50	79	66
0.50 - 30	73	60

#### NOTE:

- 1) The lower limit shall apply at the band edges.
- 2) The limit decreases linearly with the logarithm of the frequency in the range 0.15 - 0.50 MHz.

#### Wired Network Port

Frequency range (MHz)	Class A		Class B	
	Quasi-peak (dB $\mu$ V)	Average (dB $\mu$ V)	Quasi-peak (dB $\mu$ V)	Average (dB $\mu$ V)
0.15 - 0.50	97-87	84-74	84-74	74-64
0.50 - 30	87	74	74	64

#### NOTE:

- 1) The lower limit shall apply at the band edges.
- 2) The limit decreases linearly with the logarithm of the frequency in the range 0.15 - 0.50 MHz.

### 5.1.2.2 Test Setup

Please refer to 4.3 section description of test setup of test setup 2 or/and setup 3. The photo of test setup please refer to ANNEX B.

### 5.1.2.3 Test Procedure

The EUT is connected to the power mains through a LISN which provides 50  $\Omega$ /50  $\mu$ H of coupling impedance for the measuring instrument. The test frequency range is from 150 kHz to 30 MHz. The maximum conducted interference is searched using Peak (PK), Quasi-peak (QP) and Average (AV) detectors; the emission levels that are more than the AV and QP limits, and that have narrow margins from the AV and QP limits will be re-measured with AV and QP detectors. Tests for both L phase and N phase lines of the power mains connected to the EUT are performed.

Measurement of common mode (asymmetric mode)voltage emissions at wired network ports for attachment of unshielded balanced pairs shall be performed with the wired network port connected by a cable to an AAN. The AAN shall define the common mode termination impedance seen by the wired network port during the emission measurements.

The voltage division factor shall be added to the measured voltage measured by the receiver directly at the voltage measurement port of the AAN and the result compared with the voltage limits as applicable.

Use the following spectrum analyzer settings:

RBW = 9 kHz

VBW  $\geq$  RBW

Sweep = 10 ms

Detector function =peak & Average

Trace = max hold

#### 5.1.2.4 Test Result and Test Equipment List

Please refer to ANNEX A.2.

### 5.1.3 Harmonic Current Emissions

#### 5.1.3.1 Classification of equipment

Class A:

- balanced three-phase equipment;
- household appliances, excluding equipment identified as Class D;
- tools, excluding portable tools;
- dimmers for incandescent lamps;
- audio equipment.

Equipment not specified in one of the three other classes shall be considered as Class A equipment.

Class B:

- portable tools;
- arc welding equipment which is not professional equipment.

Class C:

- lighting equipment.

Class D:

Equipment having a specified power according to 6.2.2 less than or equal to 600 W, of the following types:

- personal computers and personal computer monitors;
- television receivers.
- refrigerators and freezers having one or more variable-speed drives to control compressor or motor(s).

#### 5.1.3.2 Limit

For the following four categories of equipment, limits are not specified in this document:

- equipment with a rated power of 75 W or less, other than lighting equipment;
- professional equipment with a total rated power greater than 1kW;
- symmetrically controlled heating elements with a rated power less than or equal to 200 W;
- independent dimmers for incandescent lamps with a rated power less than or equal to 1 kW.

Limits of other equipment as follow:

**Table 1–Limits for Class A equipment**

Odd harmonic		Even harmonics	
Harmonic order	Maximum permissible harmonic current	Harmonic order	Maximum permissible harmonic current
n	A	n	A
3	2.30	2	1.08
5	1.14	4	0.43
7	0.77	6	0.30
9	0.40	8≤n≤40	0.23 x 8/n
11	0.33		
13	0.21		
15≤n≤39	0.15 x 15/n		

**Table 2—Limits for Class C equipment**

Harmonic order n	Maximum permissible harmonic current expressed as a percentage of the input current at the fundamental frequency %
2	2
3	$30 \cdot \lambda^a$
5	10
7	7
9	5
$11 \leq n \leq 39$ (odd harmonics only)	3

<sup>a</sup>  $\lambda$  is the circuit power factor.

**Table 3—Limits for Class D equipment**

Harmonic order n	Maximum permissible harmonic current per watt mA/W	Maximum permissible harmonic current A
3	3.4	2.30
5	1.9	1.14
7	1.0	0.77
9	0.5	0.40
11	0.35	0.33
$13 \leq n \leq 39$ (odd harmonics only)	$3.85/n$	See Table 1

### 5.1.3.3 Application of limit

**Class A equipment:** For Class A equipment, the harmonics of the input current shall not exceed the values given in Table 1.

**Class B equipment:** For Class B equipment, the harmonics of the input current shall not exceed the values given in Table 1 multiplied by a factor of 1,5.

**Class C equipment:** For Class C equipment, as follow:

#### a) Active input power > 25 W

For lighting equipment having an active input power greater than 25 W, the harmonic currents shall not exceed the relative limits given in Table 2.

However, the limits given in Table 1 apply to incandescent lighting equipment that has built-in dimmers or consists of dimmers built in an enclosure.

For discharge lighting equipment that has built-in dimmers or consists of independent dimmers or dimmers built in an enclosure, the following conditions apply:

- the harmonic current values for the maximum load condition derived from the percentage limits given in Table 2 shall not be exceeded;
- in any dimming position, the harmonic current shall not exceed the value of current allowed in the maximum load condition;
- the equipment shall be tested according to the conditions given in Clause C.5 (see the last paragraph of C.5.3).

**b) Rated power  $\leq 25$  W**

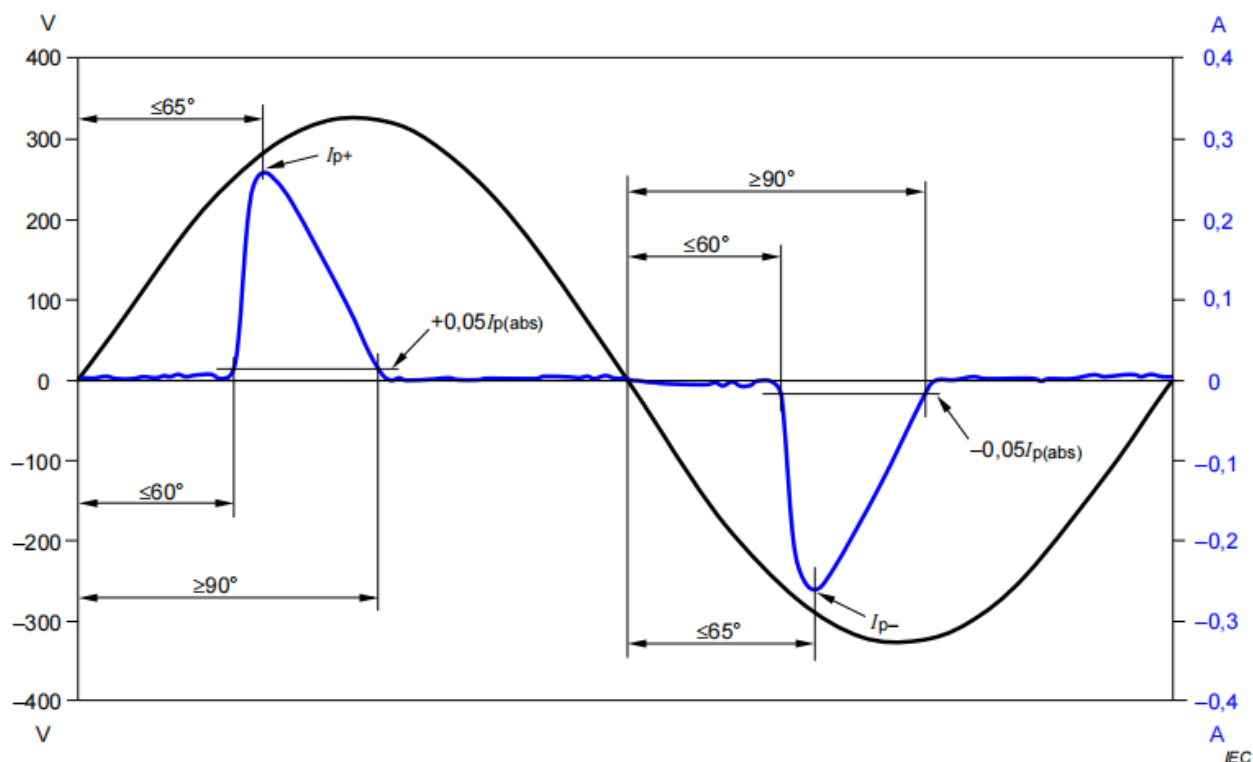

NOTE  $I_{p(abs)}$  is the higher absolute value of  $I_{p+}$  and  $I_{p-}$ .

Discharge lighting equipment having an active input power smaller than or equal to 25 W shall comply with one of the following two sets of requirements:

-the harmonic currents shall not exceed the power-related limits of Table 3, column 2, or:-the third harmonic current, expressed as a percentage of the fundamental current, shall not exceed 86% and the fifth harmonic current shall not exceed 61%. Also, the waveform of the input current shall be such that it reaches the 5% current threshold before or at  $60^\circ$ , has its peak value before or at  $65^\circ$  and does not fall below the 5% current threshold before  $90^\circ$ , referenced to any zero crossing of the fundamental supply voltage. The current threshold is 5% of the highest absolute peak value that occurs in the measurement window, and the phase angle measurements are made on the cycle that includes this absolute peak value. See above figure.

If the discharge lighting equipment has a built-in dimming device, measurement is made only in the full load condition.

**Class D equipment:** For Class D equipment, the harmonics of the input current shall not exceed the values given in Table 3.

**5.1.3.4 Test Setup**

Please refer to 4.3 section description of test setup of test setup 4. The photo of test setup please refer to ANNEX B.

**5.1.3.5 Test Procedure**

The EUT is placed on the top of a wooden table 0.8 m above the ground and operated to produce the

maximum harmonic components under normal operating conditions for each successive harmonic component in turn.

The correspondent test program of test instrument to measure the current harmonics emanated from EUT is chosen. The measure time shall be not less than the necessary for the EUT to be exercised.

#### 5.1.3.6 Test Result and Test Equipment List

Please refer to ANNEX A.3.

## 5.1.4 Voltage Fluctuations and Flicker

### 5.1.4.1 Limit

Test Item	Limit	Note
Pst	1.0	Short-term flicker indicator
Plt	0.65	Long-term flicker indicator
Tdt	0.5	Maximum time that dt exceeds 3%
dmax (%)	4%	Maximum relative voltage change
dc (%)	3.3%	Relative steady-state voltage change

### 5.1.4.2 Test Setup

Please refer to 4.3 section description of test setup of test setup 5. The photo of test setup please refer to ANNEX B.

### 5.1.4.3 Test Procedure

During the Flicker measurement, the measure time shall include that part of whole operation changes. The observation period for short-term flicker indicator is 10 minutes and the observation period for long-term flicker indicator is 2 hours. The test specifications refer the next table.

No.	Specification	Value
1	Test Frequency	50 Hz
2	Test Voltage	230 VAC
3	Waveform	Sine
4	Test Time	10 minutes for Pst; 2 hours for Plt

### 5.1.4.4 Test Result and Test Equipment List

Please refer to ANNEX A.4.

## 5.2 Immunity Tests

### 5.2.1 Test Performance Criteria for Immunity Test

#### 5.2.1.1 Performance Criteria (EN 301489-1)

##### 5.2.1.1.1 General Performance Criteria

##### **Performance criteria for continuous phenomena**

During the test, the equipment shall:

- continue to operate as intended;
- not unintentionally transmit;
- not unintentionally change its operating state;
- not unintentionally change critical stored data.

##### **Performance criteria for transient phenomena**

For all ports and transient phenomena with the exception described below, the following applies:

- The application of the transient phenomena shall not result in a change of the mode of operation (e.g. unintended transmission) or the loss of critical stored data.
- After application of the transient phenomena, the equipment shall operate as intended.

For surges applied to symmetrically operated wired network ports intended to be connected directly to outdoor lines the following criteria applies:

- For products with only one symmetrical port intended for connection to outdoor lines, loss of function is allowed, provided the function is self-recoverable, or can be otherwise restored. Information stored in non-volatile memory, or protected by a battery backup, shall not be lost.
- For products with more than one symmetrical port intended for connection to outdoor lines, loss of function on the port under test is allowed, provided the function is self-recoverable. Information stored in non-volatile memory, or protected by a battery backup, shall not be lost.

Note: For a 70 % residual voltage dip and voltage interruption tests in the case where the equipment is powered solely from the AC mains supply (without the use of a parallel battery back-up) , above Performance criteria for transient phenomena is not applicable. The following criteria are used to replace it:

- volatile user data may have been lost and if applicable the communication link need not to be maintained and lost functions should be recoverable by user or operator.
- no unintentional responses shall occur at the end of the test, when the voltage is restored to nominal.
- in the event of loss of function(s) or in the event of loss of user stored data, this fact shall be recorded.

## 5.2.1.2 Performance criteria (EN 301489-3)

### 5.2.1.2.1 General Performance Criteria

The performance criteria are used to make an assessment whether a radio equipment passes or fails immunity tests.

Only the performance criteria specified in the present document or in ETSI EN 301 489-1 [1] where referenced shall apply.

The provisions of ETSI EN 301 489-1 [1], clause 6, shall apply together with the following.

Continuous and non-continuous operation	Operating modes
<p>Latency is the time delay between the initiation and the completion of operation of the EUT. Correct functioning requires completing the relevant operation within the maximum latency time.</p> <p>Where the maximum latency is specified in the applicable harmonised radio standard (in the wanted performance criterion, or an acknowledge requirement), that value shall be used.</p> <p>Where this is not the case, then the maximum latency is that required by the intended use of the EUT.</p>	<p>Where the EUT has more than one mode of operation (see clause 4.4.1), an unplanned transition from one mode to another is considered as an unintentional response.</p> <p>The EUT shall be tested in all modes to confirm there are no such unintentional responses.</p>

### 5.2.1.3 Performance criteria (EN 301489-17)

#### 5.2.1.3.1 General Performance Criteria

Type	During test	After test
Criterion A	Shall operate as intended. (see note). Shall be no loss of function. Shall be no unintentional transmissions.	Shall operate as intended. Shall be no degradation of performance. Shall be no loss of function. Shall be no loss of critical stored data.
Criterion B	May be loss of function.	Functions shall be self-recoverable. Shall operate as intended after recovering. Shall be no loss of critical stored data.
Criterion C	May be loss of function.	Functions shall be recoverable by the operator. Shall operate as intended after recovering. Shall be no loss of critical stored data

NOTE: For equipment that supports a PER or FER, the minimum performance level shall be a PER or FER less than or equal to 10 %.

For equipment that does not support a PER or a FER, the minimum performance level shall be no loss of the wireless transmission function needed for the intended use of the equipment.

#### 5.2.1.3.2 Performance criteria for Continuous phenomena

The performance criteria A shall apply.

Where the EUT is a transmitter in standby mode, unintentional transmission shall not occur during the test.

Where the EUT is a transceiver in receive mode, unintentional transmission shall not occur during the test.

#### 5.2.1.3.3 Performance criteria for Transient phenomena

The performance criteria B shall apply, except for voltage dips greater than or equal to 100 ms and voltage interruptions of 5 000 ms duration, for which performance criteria C shall apply.

Where the EUT is a transmitter in standby mode, unintentional transmission shall not occur as a result of the application of the test.

Where the EUT is a transceiver in receive mode, unintentional transmission shall not occur as a result of the application of the test.

## 5.2.2 Electrostatic Discharge

### 5.2.2.1 Test Specification

Specification	Value
Basic Standard	EN 61000-4-2
Discharge Impedance	330 Ohm / 150 pF
Discharge Voltage	Air Discharge: 2 kV; 4 kV; 8 kV; Contact Discharge: 4 kV
Polarity	Positive / Negative
Number of Discharge	Minimum 20 times at each test point
Discharge Mode	Single discharge
Discharge Period	1 second minimum

### 5.2.2.2 Test Setup

Please refer to 4.3 section description of test setup of test setup 6. The photo of test setup please refer to ANNEX B.

### 5.2.2.3 Test Procedure

1. Electrostatic discharges are applied only to those points and surfaces of the EUT that are accessible to users during normal operation.
2. The test is performed with at least ten single discharges on the pre-selected points in the most sensitive polarity.
3. The time interval between two successive single discharges is at least 1 second.
4. The ESD generator is held perpendicularly to the surface to which the discharge is applied and the return cable is at least 0.2 meters from the EUT.
5. Contact discharges are applied to the non-insulating coating, with the pointed tip of the generator penetrating the coating and contacting the conducting substrate.
6. Air discharges are applied with the round discharge tip of the discharge electrode approaching the EUT as fast as possible (without causing mechanical damage) to touch the EUT. After each discharge, the ESD generator is removed from the EUT and re-triggered for a new single discharge. The test is repeated until all discharges were completed.
7. At least ten single discharges (in the most sensitive polarity) are applied to the Horizontal Coupling Plane at points on each side of the EUT. The ESD generator is positioned vertically at a distance of 0.1 meters from the EUT with the discharge electrode touching the HCP.
8. At least ten single discharges (in the most sensitive polarity) are applied to the center of one vertical edge of the Vertical Coupling Plane in sufficiently different positions that the four faces of the EUT were completely illuminated. The VCP (dimensions 0.5 m\*0.5 m) is placed vertically to and 0.1 meters from the EUT.

### 5.2.2.4 Test Result and Test Equipment List

Please refer to ANNEX A.5.

## 5.2.3 Radio Frequency Electromagnetic Field

### 5.2.3.1 Test Specification

Specification	Value
Basic Standard	EN 61000-4-3
Frequency Range	80 MHz to 6000 MHz
Field Strength	3 V/m (unmodulated, r.m.s)
Modulation	1 kHz sine wave, 80%, AM modulation
Frequency Step	1% of fundamental
Polarity of Antenna	Horizontal and Vertical
Test Distance	3 m
Antenna Height	1.5 m
Dwell Time	3 seconds

### 5.2.3.2 Test Setup

Please refer to 4.3 section description of test setup of test setup 7. The photo of test setup please refer to ANNEX B.

### 5.2.3.3 Test Procedure

PER Test:

Before testing, we should set the base station(CMW500) to the mode that needs to be tested, such as Bluetooth or WIFI, then set EUT to the corresponding mode and connect to Base station. Adjust the base station interface to the PER interface, and observe the PER value on the base station interface by adding interference signal during the test.

The test procedure is in accordance with EN 61000-4-3.

1. The testing is performed in a fully anechoic chamber. The transmit antenna is located at a distance of 3 meters from the EUT.
2. The test signal is 80% amplitude modulated with a 1 kHz sine wave.
3. The frequency range is swept from 80 MHz to 6000 MHz with the exception of the exclusion band for transmitters, receivers and duplex transceivers. The rate of sweep does not exceed  $1.5 \times 10^{-3}$  decade/s. Where the frequency range is swept incrementally, the step size is 1% of fundamental.
4. The dwell time at each frequency shall be not less than the time necessary for the EUT to be able to respond.
5. The field strength level is 3 V/m.
6. When equipment can be used in different orientations (i.e. vertical or horizontal) all sides shall be exposed to the field during the test. When technically justified, some EUTs can be tested by exposing fewer faces to the generating antenna. In other cases, as determined for example by the type and size of EUT or the frequencies of test, more than four azimuths may need to be exposed, but only the worst side data is reported in this report.

#### 5.2.3.4 Test Result and Test Equipment List

Please refer to ANNEX A.6.

## 5.2.4 Fast Transients Common Mode

### 5.2.4.1 Test Specification

Specification	Value
Basic Standard	EN 61000-4-4
Test Voltage	AC Power Port: 1 kV.
	DC Power Ports, Signal Ports, Control Ports, Wired Network Ports: 0.5 kV.
Polarity	Positive / Negative
Impulse Frequency	5 kHz; 100 kHz only for xDSL wired network port
Impulse Wave Shape	5/50 ns
Burst Duration	15 ms
Burst Period	300 ms
Test Duration	> 1 min

### 5.2.4.2 Test Setup

Please refer to 4.3 section description of test setup of test setup 8. The photo of test setup please refer to ANNEX B.

### 5.2.4.3 Test Procedure

1. The EUT is tested with 1000 V discharges to the AC power input leads, and 500 V for wired network ports/ control ports/ DC power ports.
2. Both positive and negative polarity discharges are applied.
3. The length of the "hot wire" from the coaxial output of the EFT generator to the terminals on the EUT should not exceed 1m.
4. The duration time of each test sequential is 1min.
5. The transient / burst waveform is in accordance with IEC 61000-4-4, 5/50 ns.

### 5.2.4.4 Test Result and Test Equipment List

Please refer to ANNEX A.7.

### 5.2.5 Transients and Surges

Specification	Value
Basic Standard	ISO 7637-2
Immunity Test Level	III
Voltage	DC 12 V/24V
Test Pulse Number	1, 2a, 2b, 3a, 3b, 4
Test Times	For the purpose of EMC testing it is sufficient to apply pulses 1, 2a, 2b and 4, 10 times each, and apply the test pulses 3a and 3b for 20 minutes each.

#### 5.2.5.1 Test Setup

Please refer to 4.3 section description of test setup of test setup 9. The photo of test setup please refer to ANNEX B.

#### 5.2.5.2 Test Procedure

1. The immunity of ESA representative of its type shall be tested by the method(s) according to ISO 7637-2: 2011.
2. For test pulses 3a and 3b, the leads between the terminals of the test pulse generator and the DUT shall be laid out in a straight parallel line at a height of ( 500+10 mm) above the ground plane and shall have a length of (0,5 ± 0,1) m.
3. Please refer to Annex B for the photographs of the Test Configuration.

#### 5.2.5.3 Test Result and Test Equipment List

Please refer to ANNEX A.8.

## 5.2.6 Surges

### 5.2.6.1 Test Specification

#### AC Power Port and Wired Network Port

Specification	Value	
Ports class	AC Power Port	Wired Network Port
Basic Standard	EN 61000-4-5	
Waveform	Voltage: 1.2/50 $\mu$ s	Voltage: 1.2/50us, or 10/700 $\mu$ s See Note 2,3,4
Test Voltage	line to ground 2 kV, line to line 1 kV; line to ground 1 kV, line to line 0.5 kV(Note 1)	0.5 kV, or 1 kV See Note 2,3,4
Polarity	Positive / Negative	
Phase Angle	0°, 90°, 180°, 270°	N/A
Repetition Rate	60 seconds	
Times	5 times per condition	

Note 1: The test level for AC mains ports, in telecommunications centres.

Note 2: The test level for wired network ports, intended to be connected to indoor cables (longer than 30 m) shall be 0,5 kV (applied line to ground, or shield to ground).The test generator shall provide the 1,2/50  $\mu$ s pulse.

Note 3: The test level for symmetrically operated, wired network ports, intended to be directly connected to wired network ports via outdoor cables, shall be 1 kV (applied lines to ground).The test generator shall provide the 10/700  $\mu$ s pulse.

Note 4: The test level for non-symmetrically operated wired network ports, intended to be directly connected to wired network ports via outdoor cables, shall be 1 kV (applied line to ground, or shield to ground) and 0,5 kV (applied line to line).The test generator shall provide the 1,2/50  $\mu$ s pulse.

### 5.2.6.2 Test Setup

Please refer to 4.3 section description of test setup of test setup 10. The photo of test setup please refer to ANNEX B.

### 5.2.6.3 Test Procedure

The EUT and the auxiliary equipment are placed on a table of 0.8 m heights above a metal ground reference plane. The size of ground plane is greater than 1 m\*1 m and project beyond the EUT by at least 0.1 m on all sides. The ground plane is connected to the protective earth. The length of power cord between the coupling device and the EUT is less than 2 meters (provided by the manufacturer).

The surge waveform has been verified before the test, and the waveform is normal.

The EUT is connected to the power mains through a coupling device that directly couples the surge interference signal. The surge noise is applied synchronized to the voltage phase at the zero crossing and the peak value of the AC voltage wave (positive and negative).

The surges are applied line to line and line(s) to earth. When testing line to earth the test voltage is applied successively between each of the lines and earth. Set up to the test level specified increased the test voltage. All lower levels including the selected test level are tested. The polarity of each surge level included positive and negative test pulses.

#### 5.2.6.4 Test Result and Test Equipment List

Please refer to ANNEX A.9.

## 5.2.7 Radio Frequency Common Mode

### 5.2.7.1 Test Specification

Specification	Value
Basic Standard	EN 61000-4-6
Frequency Range	0.15 MHz – 80 MHz
Field Strength	3 V rms (unmodulated, r.m.s)
Modulation	1 kHz sine wave, 80% AM
Frequency Step	1% of fundamental
Coupled Cable	AC Power Port; DC Power Port; Wired Network Port

### 5.2.7.2 Test Setup

Please refer to 4.3 section description of test setup of test setup 11. The photo of test setup please refer to ANNEX B.

### 5.2.7.3 Test Procedure

PER Test:

Before testing, we should set the base station(CMW500) to the mode that needs to be tested, such as Bluetooth or WIFI, then set EUT to the corresponding mode and connect to Base station. Adjust the base station interface to the PER interface, and observe the PER value on the base station interface by adding interference signal during the test.

The test procedure was in accordance with EN 61000-4-6.

1. The EUT shall be tested within its intended operating and climatic conditions.
2. The test shall be performed with the test generator connected to each of the coupling and decoupling devices in turn, while the other non-excited RF input ports of the coupling devices are terminated by a 50 Ohm load resistor.
3. The test signal is 80% amplitude modulated with a 1 kHz sine wave.
4. The frequency range is swept from 150 kHz to 80 MHz, using the signal level established during the setting process and with a disturbance signal of 80% amplitude. The sweep rate shall not exceed  $1.5 \times 10^{-3}$  decades/s. The step size shall not exceed 1% of the start and thereafter 1% of the preceding frequency value where the frequency is swept incrementally.
5. The dwell time at each frequency shall not be less than the time necessary for the EUT to be exercised, and able to respond. Sensitive frequencies such as clock frequencies and harmonics or frequencies of dominant interest, shall be analyzed separately.
6. Attempts should be made to fully exercise the EUT during test, and to fully interrogate all exercise modes selected for susceptibility.

### 5.2.7.4 Test Result and Test Equipment List

Please refer to ANNEX A.10.

## 5.2.8 Voltage Dips and Interruptions

### 5.2.8.1 Test Specification

Specification	Value
Basic Standard	EN 61000-4-11
Voltage Dips	0% Residual: 10 ms; 0% Residual: 20 ms; 70% Residual: 500 ms
Voltage Interruptions	0% Residual: 5000 ms
Voltage Phase Angle	0°

### 5.2.8.2 Test Setup

Please refer to 4.3 section description of test setup of test setup 12. The photo of test setup please refer to ANNEX B.

### 5.2.8.3 Test Procedure

The power cord is used as supplied by the manufacturer. The EUT was connected to the line output of the Voltage Dips and Interruption Generator.

The EUT is tested for a) 0% voltage residual of supplied voltage with duration of 10 ms; b) 0% voltage residual of supplied voltage with duration of 20 ms; c) 70% voltage residual of supplied voltage and duration 500 ms. Both of the dip tests are carried out for a sequence of three voltage dips with intervals of 10 seconds.

0% voltage residual of supplied voltage with duration of 5000 ms is followed, which is a sequence of three voltage interruptions with intervals of 10 seconds.

Voltage reductions occur at 0 degrees crossover point of the voltage waveform. The performance of the EUT is checked after the voltage dip or interruption.

### 5.2.8.4 Test Result and Test Equipment List

Please refer to ANNEX A.11.

# ANNEX A TEST RESULTS

## A.1 Radiated Emission

Note: The marked spikes near 2400 MHz with circle should be ignored because they are 2.4G WIFI or Bluetooth carrier frequencies.

Sample No.	S01	Temperature	22.8°C
Humidity	39%RH	Pressure	101.7kPa
Test Engineer	Liao Ziyang	Test Date	2025.11.28-2025.12.03

### Test Mode 1

#### 1) Test Antenna Vertical, 30 MHz – 1 GHz

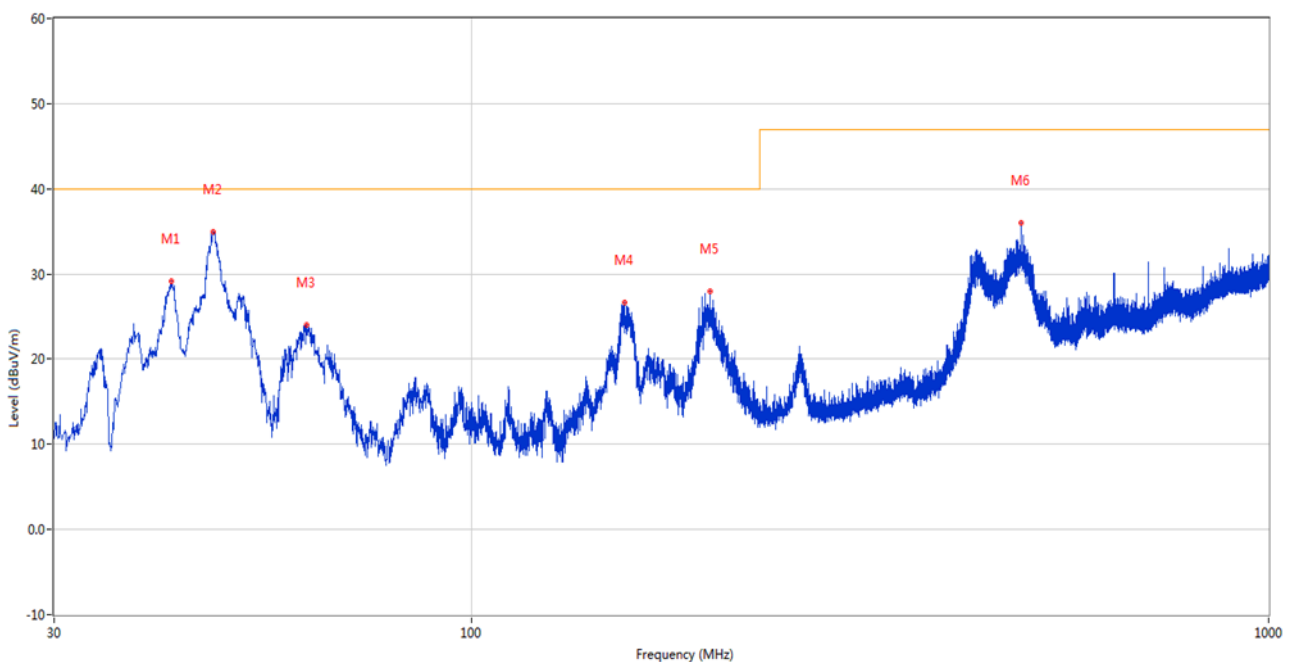

No.	Frequency (MHz)	Results (dBuV/m)	Factor (dB)	Limit (dBuV/m)	Margin (dB)	Detector	Table (Degree)	Height (cm)	Antenna	Verdict
1	42.125	29.18	-25.32	40.0	10.82	Peak	266.70	100	Vertical	Pass
2	47.460	34.93	-24.33	40.0	5.07	Peak	29.10	100	Vertical	Pass
3	62.156	24.06	-26.10	40.0	15.94	Peak	173.90	100	Vertical	Pass
4	155.615	26.70	-28.67	40.0	13.30	Peak	43.20	100	Vertical	Pass
5	199.362	28.02	-24.89	40.0	11.98	Peak	58.70	100	Vertical	Pass
6	489.101	35.97	-16.97	47.0	11.03	Peak	236.40	100	Vertical	Pass

2) Test Antenna Horizontal, 30 MHz – 1 GHz

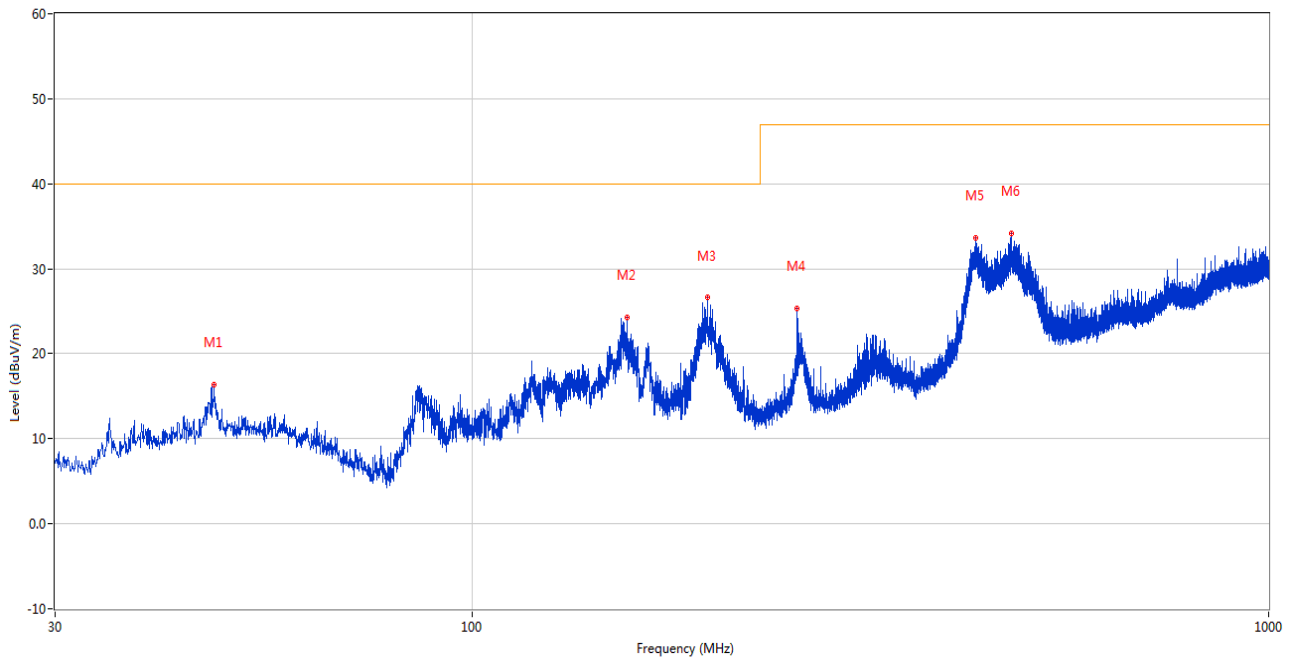

No.	Frequency (MHz)	Results (dBuV/m)	Factor (dB)	Limit (dBuV/m)	Margin (dB)	Detector	Table (Degree)	Height (cm)	Antenna	Verdict
1	47.508	16.37	-24.33	40.0	23.63	Peak	144.10	200	Horizontal	Pass
2	156.730	24.29	-28.51	40.0	15.71	Peak	216.20	200	Horizontal	Pass
3	197.616	26.58	-24.69	40.0	13.42	Peak	115.90	100	Horizontal	Pass
4	256.252	25.32	-23.19	47.0	21.68	Peak	221.50	100	Horizontal	Pass
5	428.525	33.67	-18.61	47.0	13.33	Peak	10.40	100	Horizontal	Pass
6	475.909	34.14	-17.85	47.0	12.86	Peak	356.10	100	Horizontal	Pass

Equipment Information						
Equipment Name	Supplier	Model	Serial No.	Cal. Date	Cal. Due	Use
Frequency Below 1 GHz						
EMI Receiver	Keysight	N9038A	MY53220118	2025.06.16	2026.06.15	<input checked="" type="checkbox"/>
Amplifier (30MHz-1GHz)	COM-MV	ZT30-1000M	B2017119082	2025.11.25	2026.11.24	<input checked="" type="checkbox"/>
Test Antenna- Bi-Log	SCHWARZB ECK	VULB 9163	9163-624	2024.07.06	2027.07.05	<input checked="" type="checkbox"/>
Anechoic Chamber (#5)	ChangNing	9m*6m*6m	104-1	2025.10.13	2028.10.12	<input checked="" type="checkbox"/>
Description	Supplier	Name	Version	/		Use
Test Software	BALUN	BL410-E	V22.930	/		<input checked="" type="checkbox"/>

Test Mode 1

3) Test Antenna Vertical, 1 GHz – 6 GHz

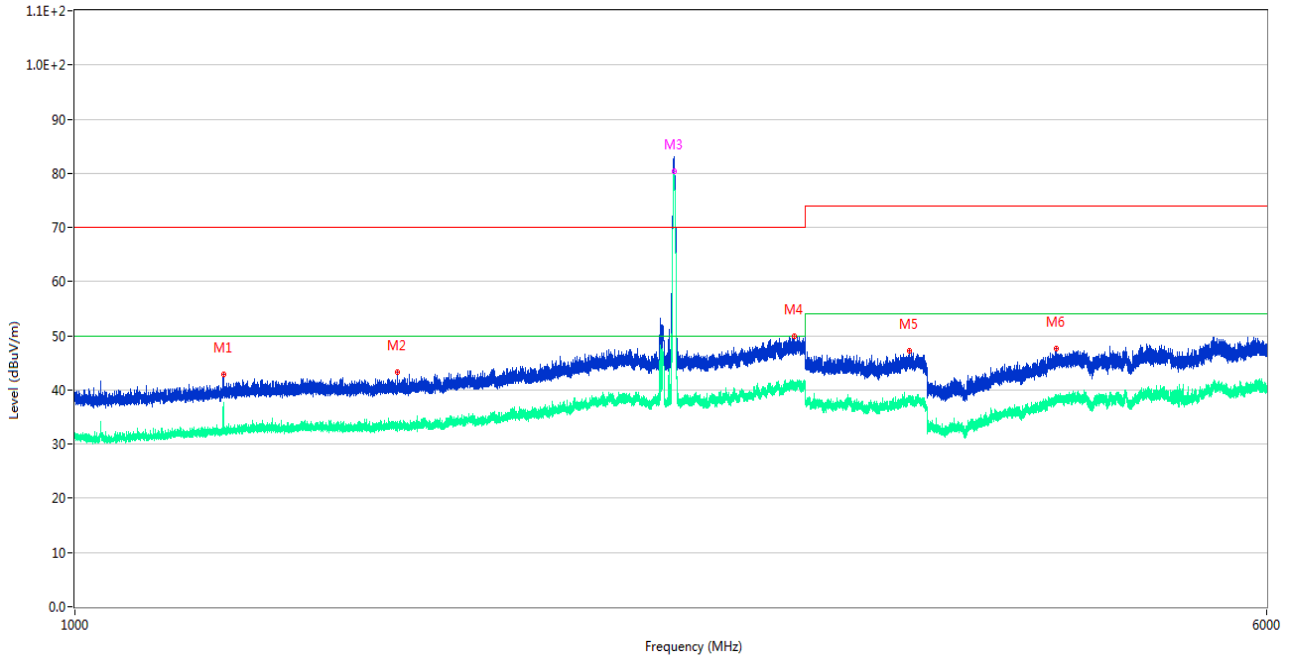

No.	Frequency (MHz)	Results (dBUV/m)	Factor (dB)	Limit (dBUV/m)	Margin (dB)	Detector	Table (Degree)	Height (cm)	Antenna	Verdict
1	1250.300	42.78	-13.85	70.0	27.22	Peak	42.00	100	Vertical	Pass
1**	1250.300	37.19	-13.85	50.0	12.81	AV	42.00	100	Vertical	Pass
2	1625.000	43.27	-13.24	70.0	26.73	Peak	230.60	100	Vertical	Pass
2**	1625.000	32.88	-13.24	50.0	17.12	AV	230.60	100	Vertical	Pass
3	2461.100	83.00	-7.62	70.0	-13.00	Peak	0.00	100	Vertical	N/A
3**	2461.100	80.30	-7.62	50.0	-30.30	AV	0.00	100	Vertical	N/A
4	2950.200	49.94	-3.82	70.0	20.06	Peak	53.50	100	Vertical	Pass
4**	2950.200	40.55	-3.82	50.0	9.45	AV	53.50	100	Vertical	Pass
5	3506.550	47.18	-6.11	74.0	26.82	Peak	225.30	100	Vertical	Pass
5**	3506.550	38.16	-6.11	54.0	15.84	AV	225.30	100	Vertical	Pass
6	4374.900	47.61	-1.45	74.0	26.39	Peak	200.10	100	Vertical	Pass
6**	4374.900	38.61	-1.45	54.0	15.39	AV	200.10	100	Vertical	Pass

4) Test Antenna Horizontal, 1 GHz – 6 GHz

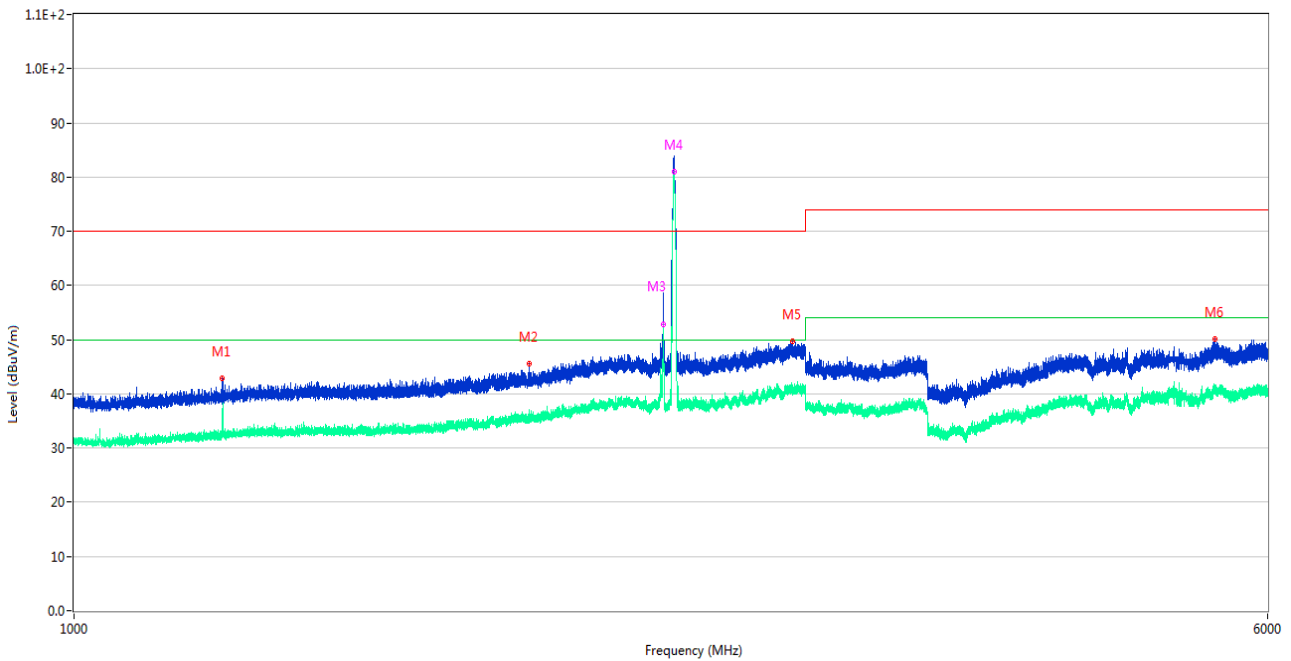

No.	Frequency (MHz)	Results (dBuV/m)	Factor (dB)	Limit (dBuV/m)	Margin (dB)	Detector	Table (Degree)	Height (cm)	Antenna	Verdict
1	1249.600	42.80	-13.86	70.0	27.20	Peak	197.80	100	Horizontal	Pass
1**	1249.600	35.50	-13.86	50.0	14.50	AV	197.80	100	Horizontal	Pass
2	1981.700	45.50	-10.86	70.0	24.50	Peak	257.60	100	Horizontal	Pass
2**	1981.700	35.32	-10.86	50.0	14.68	AV	257.60	100	Horizontal	Pass
3	2422.300	56.54	-7.94	70.0	13.46	Peak	84.40	100	Horizontal	N/A
3**	2422.300	52.80	-7.94	50.0	-2.80	AV	84.40	100	Horizontal	N/A
4	2461.100	83.64	-7.62	70.0	-13.64	Peak	0.00	100	Horizontal	N/A
4**	2461.100	80.96	-7.62	50.0	-30.96	AV	0.00	100	Horizontal	N/A
5	2938.600	49.77	-4.07	70.0	20.23	Peak	314.90	100	Horizontal	Pass
5**	2938.600	41.24	-4.07	50.0	8.76	AV	314.90	100	Horizontal	Pass
6	5546.100	50.09	-0.47	74.0	23.91	Peak	178.90	100	Horizontal	Pass
6**	5546.100	40.60	-0.47	54.0	13.40	AV	178.90	100	Horizontal	Pass

Equipment Information						
Equipment Name	Supplier	Model	Serial No.	Cal. Date	Cal. Due	Use
Frequency Above 1 GHz						
EMI Receiver	Keysight	N9038A	MY53220118	2025.06.16	2026.06.15	<input checked="" type="checkbox"/>
Amplifier (1-12GHz)	COM-MV	DLNAB-1000- 12000-002	18080279	2025.11.25	2026.11.24	<input checked="" type="checkbox"/>
Test Antenna- Horn	SCHWARZB ECK	BBHA 9120D	1148	2025.05.28	2028.05.27	<input checked="" type="checkbox"/>
Anechoic Chamber (#5)	ChangNing	9m*6m*6m	104-1	2025.10.13	2028.10.12	<input checked="" type="checkbox"/>
Description	Supplier	Name	Version	/		Use
Test Software	BALUN	BL410-E	V22.930	/		<input checked="" type="checkbox"/>

## A.2 Conducted Emissions

Sample No.	S01	Temperature	23.5°C
Humidity	57%RH	Pressure	101.4kPa
Test Engineer	Huang Penghui	Test Date	2025.11.21

### Test Mode 1

#### 1) AC Ports - L Phase

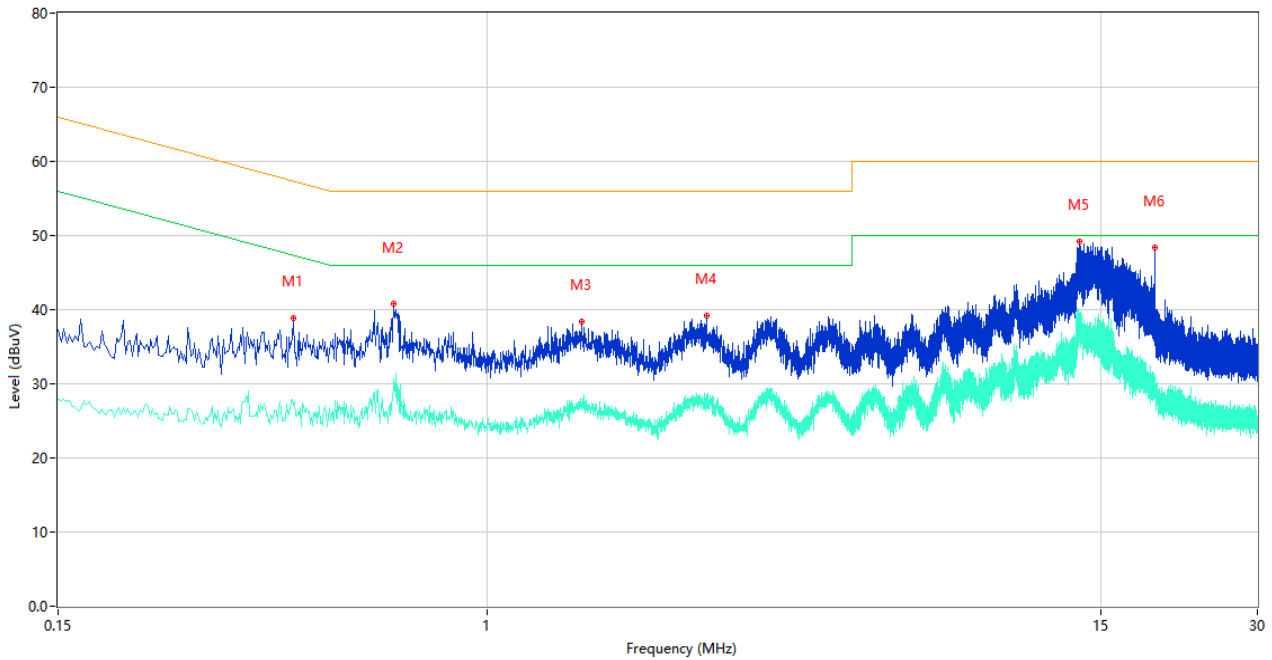

No.	Frequency (MHz)	Results (dBUV)	Factor (dB)	Limit (dBUV)	Margin (dB)	Detector	Line	Verdict
1	0.424	38.83	10.36	57.37	18.54	Peak	L	Pass
1**	0.424	27.05	10.36	47.37	20.32	AV	L	Pass
2	0.662	40.85	10.38	56.00	15.15	Peak	L	Pass
2**	0.662	30.62	10.38	46.00	15.38	AV	L	Pass
3	1.514	38.35	10.29	56.00	17.65	Peak	L	Pass
3**	1.514	26.63	10.29	46.00	19.37	AV	L	Pass
4	2.636	39.21	10.15	56.00	16.79	Peak	L	Pass
4**	2.636	27.90	10.15	46.00	18.10	AV	L	Pass
5	13.640	49.26	10.70	60.00	10.74	Peak	L	Pass
5**	13.640	38.24	10.70	50.00	11.76	AV	L	Pass
6	19.106	48.42	11.14	60.00	11.58	Peak	L	Pass
6**	19.106	30.05	11.14	50.00	19.95	AV	L	Pass

2) AC Ports - N Phase

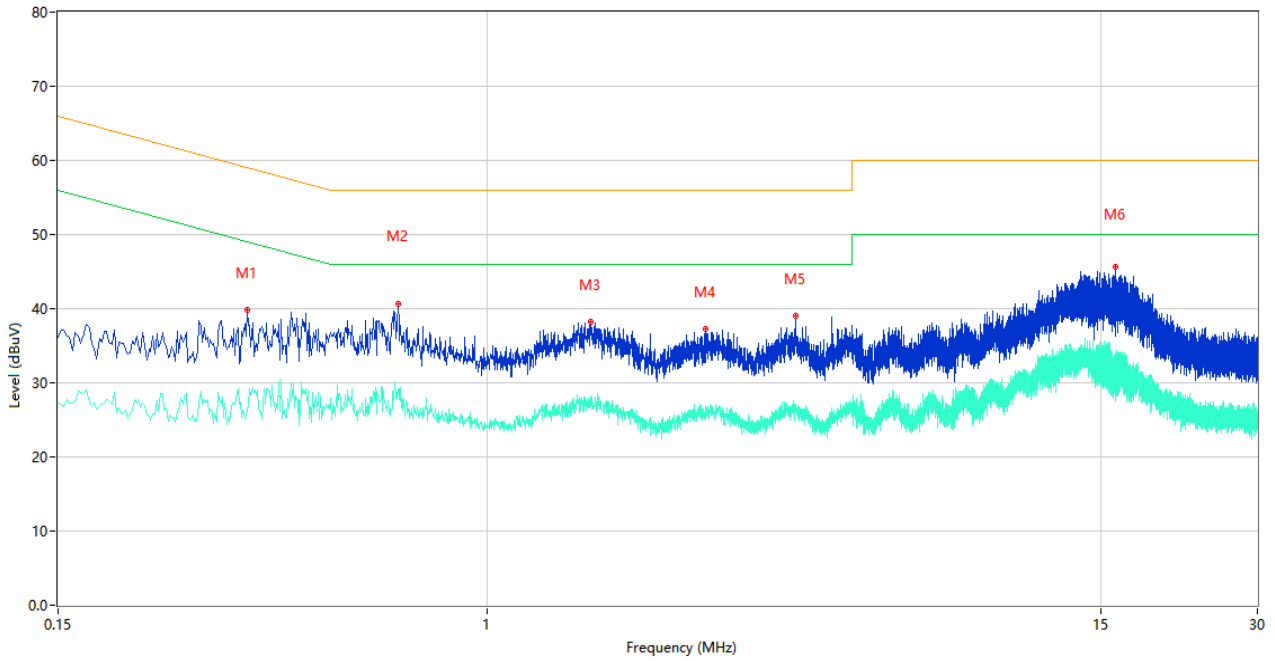

No.	Frequency (MHz)	Results (dBuV)	Factor (dB)	Limit (dBuV)	Margin (dB)	Detector	Line	Verdict
1	0.346	39.81	10.74	59.06	19.25	Peak	N	Pass
1**	0.346	26.24	10.74	49.06	22.82	AV	N	Pass
2	0.674	40.64	10.48	56.00	15.36	Peak	N	Pass
2**	0.674	29.27	10.48	46.00	16.73	AV	N	Pass
3	1.580	38.18	10.03	56.00	17.82	Peak	N	Pass
3**	1.580	27.25	10.03	46.00	18.75	AV	N	Pass
4	2.618	37.22	9.96	56.00	18.78	Peak	N	Pass
4**	2.618	26.08	9.96	46.00	19.92	AV	N	Pass
5	3.894	38.95	10.37	56.00	17.05	Peak	N	Pass
5**	3.894	26.51	10.37	46.00	19.49	AV	N	Pass
6	16.054	45.72	10.94	60.00	14.28	Peak	N	Pass
6**	16.054	33.28	10.94	50.00	16.72	AV	N	Pass

Equipment Information						
Equipment Name	Supplier	Model	Serial No.	Cal. Date	Cal. Due	Use
EMI Receiver	KEYSIGHT	N9010B	MY57110309	2025.06.16	2026.06.15	<input checked="" type="checkbox"/>
LISN	SCHWARZB ECK	NSLK 8127	8127-687	2025.04.29	2026.04.28	<input checked="" type="checkbox"/>
Shielded Room	Chang Chuang	4*4*3m	662	2025.10.12	2028.10.11	<input checked="" type="checkbox"/>
Description	Supplier	Name	Version	/		Use
Test Software	BALUN	BL410-E	V22.930	/		<input checked="" type="checkbox"/>

---

### **A.3 Harmonic Current Emissions**

Note: Not applicable.

## A.4 Voltage Fluctuations & Flicker

Sample No.	S01	Temperature	24.1°C
Humidity	52%RH	Pressure	101.7kPa
Test Engineer	Xiao Xiong	Test Date	2025.11.28

Test Mode	Test Item	Limit	Measurement Value	Verdict
Mode 1	Pst	1.0	0.02	Pass
	Plt	0.65	0.00	Pass
	Tdt	0.5	0.00	Pass
	dmax (%)	4%	0.00%	Pass
	dc (%)	3.3%	0.00%	Pass

Equipment Information						
Equipment Name	Supplier	Model	Serial No.	Cal. Date	Cal. Due	Use
HARMONICS,FLICKER&POWER ANALYSER	LAPLACE INSTRUMENTS	AC2000A	377954	2025.07.09	2026.07.08	<input checked="" type="checkbox"/>
AC TESTING POWER SOURCE	EVERFINE	DPS10300_V200	P185416CM5431114	2024.12.16	2025.12.15	<input checked="" type="checkbox"/>
Description	Supplier	Name	Version	/		Use
Test Software	LAPLACE INSTRUMENTS	HA-PC Link	V3.04	/		<input checked="" type="checkbox"/>

### A.5 Electrostatic Discharge

Sample No.	S01	Temperature	24.1°C
Humidity	52%RH	Pressure	101.7kPa
Test Engineer	Xiao Xiong	Test Date	2025.11.28

Test Mode	Discharge Type	Test Position	Test Level (kV)	Discharge Times	Result
Mode 1	Air	Camera	±2,±4,±8	240	Pass
		Fill light	±2,±4,±8	120	Pass
		Type-C port	±2,±4,±8	60	Pass
		LED	±2,±4,±8	60	Pass
		Microphone	±2,±4,±8	60	Pass
		Speaker	±2,±4,±8	240	Pass
		Shell and gap	±2,±4,±8	300	Pass
	Contact	HCP	±4	100	Pass
		VCP	±4	100	Pass
		Screw	±4	20	Pass

Note 1: The performance comply with Performance criteria for Transient phenomena.

Note 2: During the test, the PER of WIFI is less than 10%.

## ESD Discharge point

Red dot — Contact Discharged Points

Green dot — Air Discharged Points





Equipment Information						
Equipment Name	Supplier	Model	Serial No.	Cal. Date	Cal. Due	Use
ESD Test System	EMTEST	DITO	P1833222423	2025.07.28	2026.07.27	<input checked="" type="checkbox"/>

## A.6 Radio Frequency Electromagnetic Field

Sample No.	S01	Temperature	20.9℃
Humidity	41%RH	Pressure	101.7kPa
Test Engineer	Xi Zifeng	Test Date	2025.11.28

Test Mode	Test Fre. (MHz)	Test Level (V/m)	Antenna Polarity	Step (MHz)	Dwell Time (s)	Test Position	Result
Mode 1	80 - 1000	3	Horizontal	1%	3	Front; Back; Left; Right;	Pass
	80 - 1000	3	Vertical	1%	3	Front; Back; Left; Right;	Pass
	1000 - 6000	3	Horizontal	1%	3	Front; Back; Left; Right;	Pass
	1000 - 6000	3	Vertical	1%	3	Front; Back; Left; Right;	Pass

Note 1: The performance comply with Performance criteria for Continuous phenomena.

Note 2: During the test, the PER of WIFI is less than 10%.

Equipment Information						
Equipment Name	Supplier	Model	Serial No.	Cal. Date	Cal. Due	Use
Anechoic Chamber	ChangNing	8*6.3*4m	658-1	2025.10.17	2028.10.16	<input checked="" type="checkbox"/>
Signal Generator	Agilent	N5181A	MY50141752	2025.10.30	2026.10.29	<input checked="" type="checkbox"/>
Power Amplifier	OPHIR RF	5225F	1037	2024.12.16	2025.12.15	<input checked="" type="checkbox"/>
Power Amplifier	OPHIR RF	5273F	1016	2024.12.16	2025.12.15	<input checked="" type="checkbox"/>
Power Amplifier	RFLIGHT	NTWPAS-2560025	17043109	2024.12.16	2025.12.15	<input checked="" type="checkbox"/>
Power Meter	R&S	NRP-Z11	117410/11769 3	2025.04.29	2026.04.28	<input checked="" type="checkbox"/>
Field Strength Meter	Narda	EP 602	611WX80276	2025.08.25	2026.08.24	<input checked="" type="checkbox"/>
Test Antenna-Bi-Log	SCHWARZ BECK	VULB 9163	9163-977	2025.03.01	2028.02.28	<input checked="" type="checkbox"/>
Test Antenna-Horn	SCHWARZ BECK	BBHA 9120D	01917	2025.05.20	2028.05.19	<input checked="" type="checkbox"/>
Description	Supplier	Name	Version	/		Use
Test Software	BALUN	BL410-E	V22.930	/		<input checked="" type="checkbox"/>

## A.7 Fast Transients Common Mode

Sample No.	S01	Temperature	24.1°C
Humidity	52%RH	Pressure	101.7kPa
Test Engineer	Xiao Xiong	Test Date	2025.11.28

Test Mode	Test point	Test Level (kV)	Frequency (kHz)	Burst Duration (ms)	Burst Period (ms)	Result
Mode 1	L-GND	±1	5	15	300	Pass
	N-GND	±1	5	15	300	Pass
	L+N-GND	±1	5	15	300	Pass

Note 1: The performance comply with Performance criteria for Transient phenomena.

Note 2: During the test, the PER of WIFI is less than 10%.

Equipment Information						
Equipment Name	Supplier	Model	Serial No.	Cal. Date	Cal. Due	Use
Integrated test system	HTEC	HCOMPACT7	190801	2025.03.24	2026.03.23	<input checked="" type="checkbox"/>

---

## A.8 Transients and Surges

Note: Not applicable.

## A.9 Surges

Sample No.	S01	Temperature	24.1°C
Humidity	52%RH	Pressure	101.7kPa
Test Engineer	Xiao Xiong	Test Date	2025.11.28

Test Mode	Test point	Test Level (kV)	Phase	Waveform	Test Times	Time Interval (s)	Result
Mode 1	L-N	±1	0°	1.2/50µs	10	60	Pass
	L-N	±1	90°	1.2/50µs	10	60	Pass
	L-N	±1	180°	1.2/50µs	10	60	Pass
	L-N	±1	270°	1.2/50µs	10	60	Pass

Note 1: The performance comply with Performance criteria for Transient phenomena.

Note 2: During the test, the PER of WIFI is less than 10%.

Equipment Information						
Equipment Name	Supplier	Model	Serial No.	Cal. Date	Cal. Due	Use
Integrated test system	HTEC	HCOMPACT7	190801	2025.03.24	2026.03.23	<input checked="" type="checkbox"/>

## A.10 Radio Frequency Common Mode

Sample No.	S01	Temperature	20.9℃
Humidity	41%RH	Pressure	101.7kPa
Test Engineer	Xi Zifeng	Test Date	2025.11.28

Operation Mode	Test point	Test Fre. (MHz)	Test Level (V)	Step (MHz)	Dwell Time (s)	Result
Mode 1	AC	0.15 - 80	3	1%	3	Pass

Note 1: The performance comply with Performance criteria for Continuous phenomena.

Note 2: During the test, the PER of WIFI is less than 10%.

Equipment Information						
Equipment Name	Supplier	Model	Serial No.	Cal. Date	Cal. Due	Use
CONDUCTED DISTURBANCES TEST SYSTEM	SCHLODER	CDG 6000-75	126B1286	2024.04.29	2026.03.19	<input checked="" type="checkbox"/>
CDN-M2+3	SCHLODER	CDN M2+M3-16	A22101.776	2024.04.29	2026.03.19	<input checked="" type="checkbox"/>
Description	Supplier	Name	Version	/		Use
Test Software	BALUN	BL410-E	V22.930	/		<input checked="" type="checkbox"/>

### A.11 Voltage Dips and Interruptions

Sample No.	S01	Temperature	24.1°C
Humidity	52%RH	Pressure	101.7kPa
Test Engineer	Xiao Xiong	Test Date	2025.11.28

Test Mode	Test Case	Residual Voltage	Duration (ms)	Times	Interval (sec)	Result
Mode 1	Voltage Dips	0%	10	3	10	Pass
		0%	20	3	10	Pass
		70%	500	3	10	Pass
	Voltage Interruptions	0%	5000	3	10	Pass

Note 1: The performance comply with Performance criteria for Transient phenomena.

Note 2: During the test, the PER of WIFI is less than 10%.

Equipment Information						
Equipment Name	Supplier	Model	Serial No.	Cal. Date	Cal. Due	Use
Integrated test system	HTEC	HCOMPACT7	190801	2025.03.24	2026.03.23	<input checked="" type="checkbox"/>
DIPS coupling network	HTEC	HV1P16T	190303	2025.03.24	2026.03.23	<input checked="" type="checkbox"/>

## **ANNEX B TEST SETUP PHOTOS**

Please refer the document “BL-SZ25B0864-AE-1.PDF”.

## **ANNEX C EUT EXTERNAL PHOTOS**

Please refer the document “BL-SZ25B0864-AW.PDF”.

## **ANNEX D EUT INTERNAL PHOTOS**

Please refer the document “BL-SZ25B0864-AI.PDF”.

## Statement

1. The laboratory guarantees the scientificity, accuracy and impartiality of the test, and is responsible for all the information in the report, except the information provided by the customer. The customer is responsible for the impact of the information provided on the validity of the results.
2. The report without China inspection body and laboratory Mandatory Approval (CMA) mark has no effect of proving to the society.
3. For the report with CNAS mark or A2LA mark, the items marked with "☆" are not within the accredited scope.
4. This report is invalid if it is altered, without the signature of the testing and approval personnel, or without the "inspection and testing dedicated stamp" or test report stamp.
5. The test data and results are only valid for the tested samples provided by the customer.
6. This report shall not be partially reproduced without the written permission of the laboratory.
7. Any objection shall be raised to the laboratory within 30 days after receiving the report.

--END OF REPORT--