

MODELS

FTXZ-N (25/35/50).....	1
FTXS-K (25/42/50).....	4
FTXLS-K (25/35)	
FTXM-K (35/42/50)	
ATXS-K (35/50)	
FTXS-G (60/71).....	8
FTX-G (60/71).....	11
FVXG-K (25/35/50).....	15
FVXS-F (25/35/50).....	20
FVXM-F (25/35/50)	
FLXS-B(9) (25/35/50).....	24
FTX-KN (25/35).....	28

FTXZ-N (25/35/50)

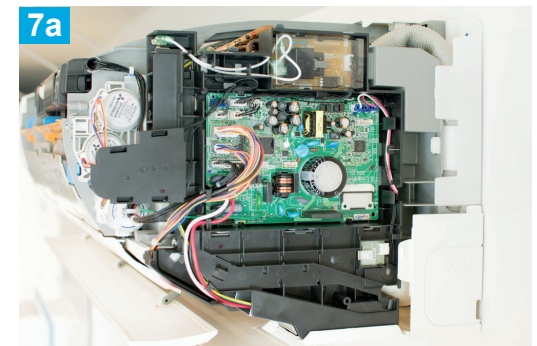
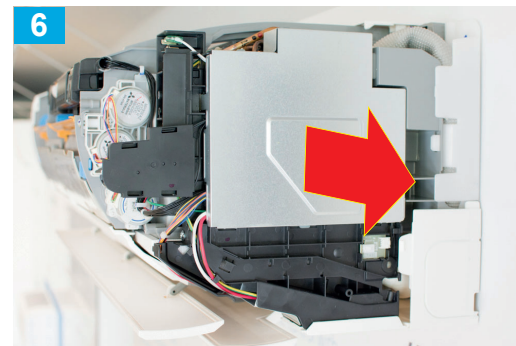
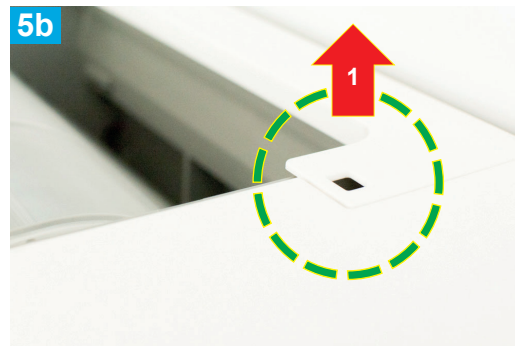
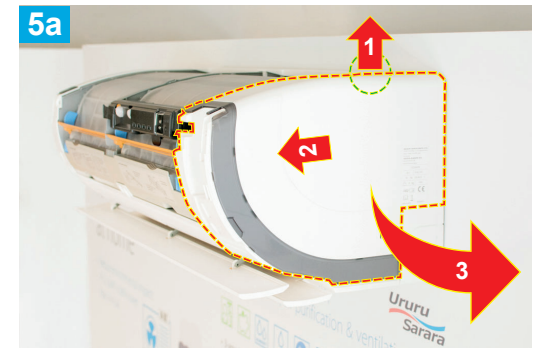
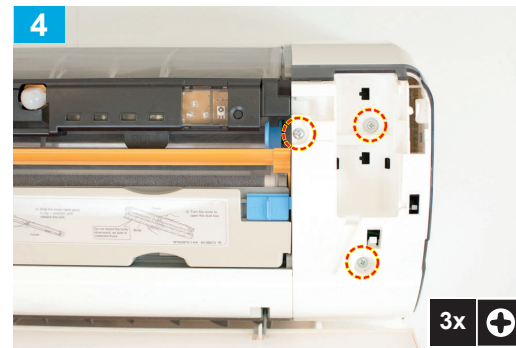
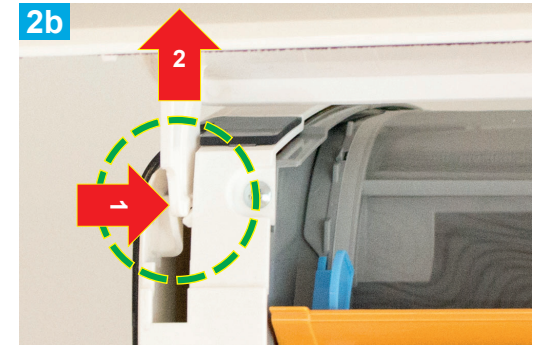
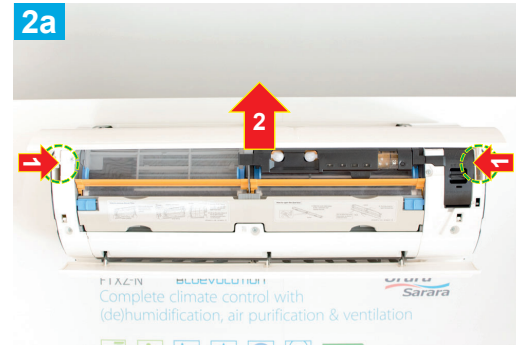
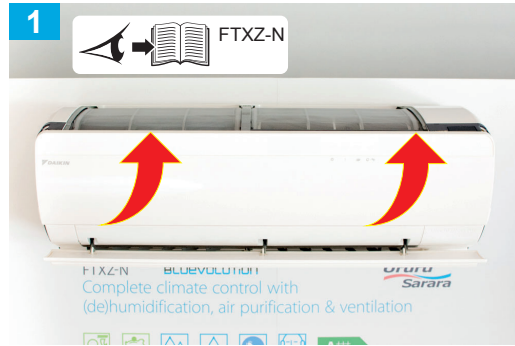
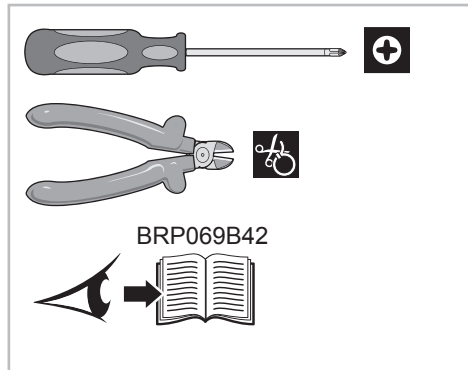
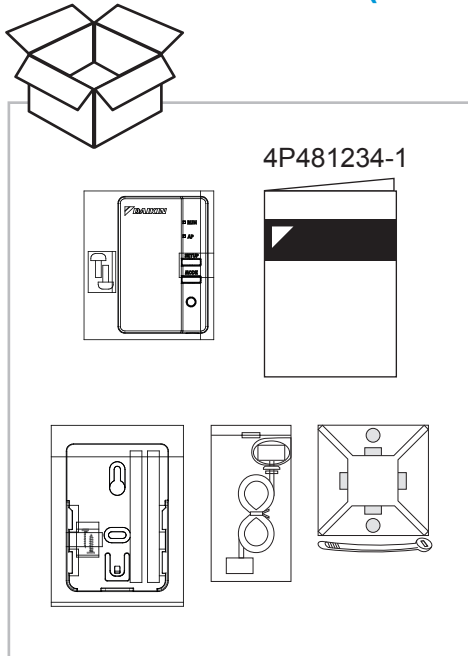

FTXZ-N (25/35/50)

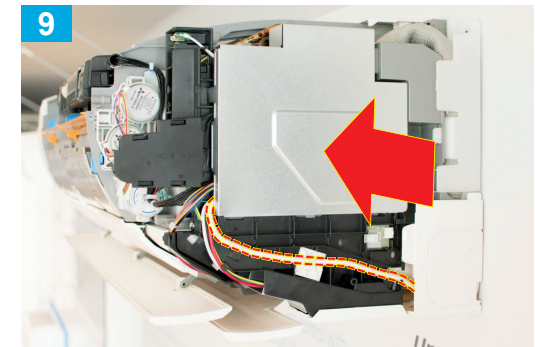
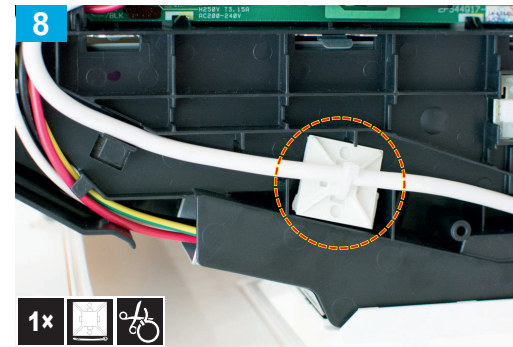
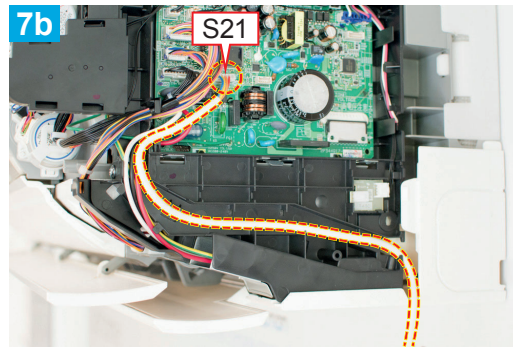

... 5 → 1 ...

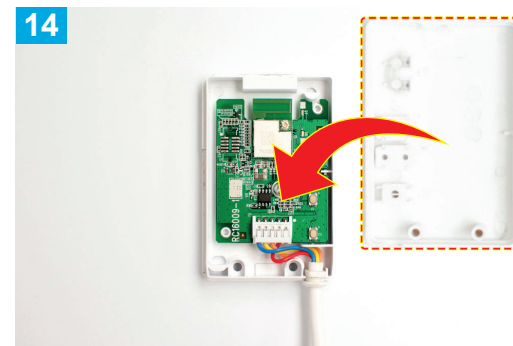
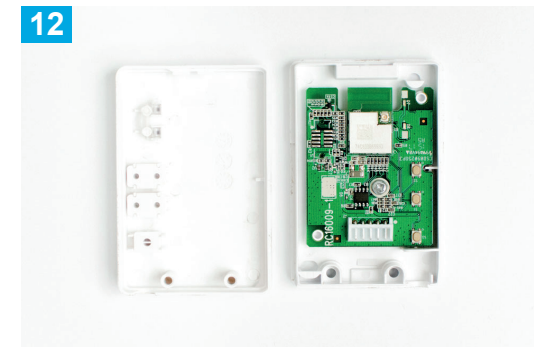
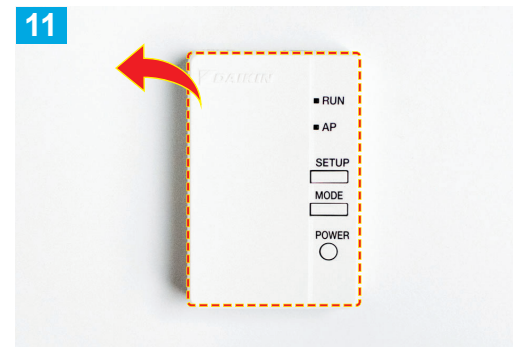
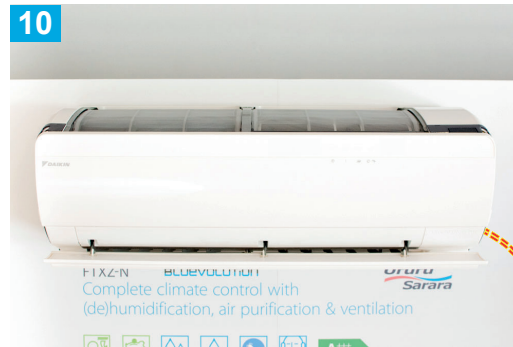

FTXZ-N (25/35/50)

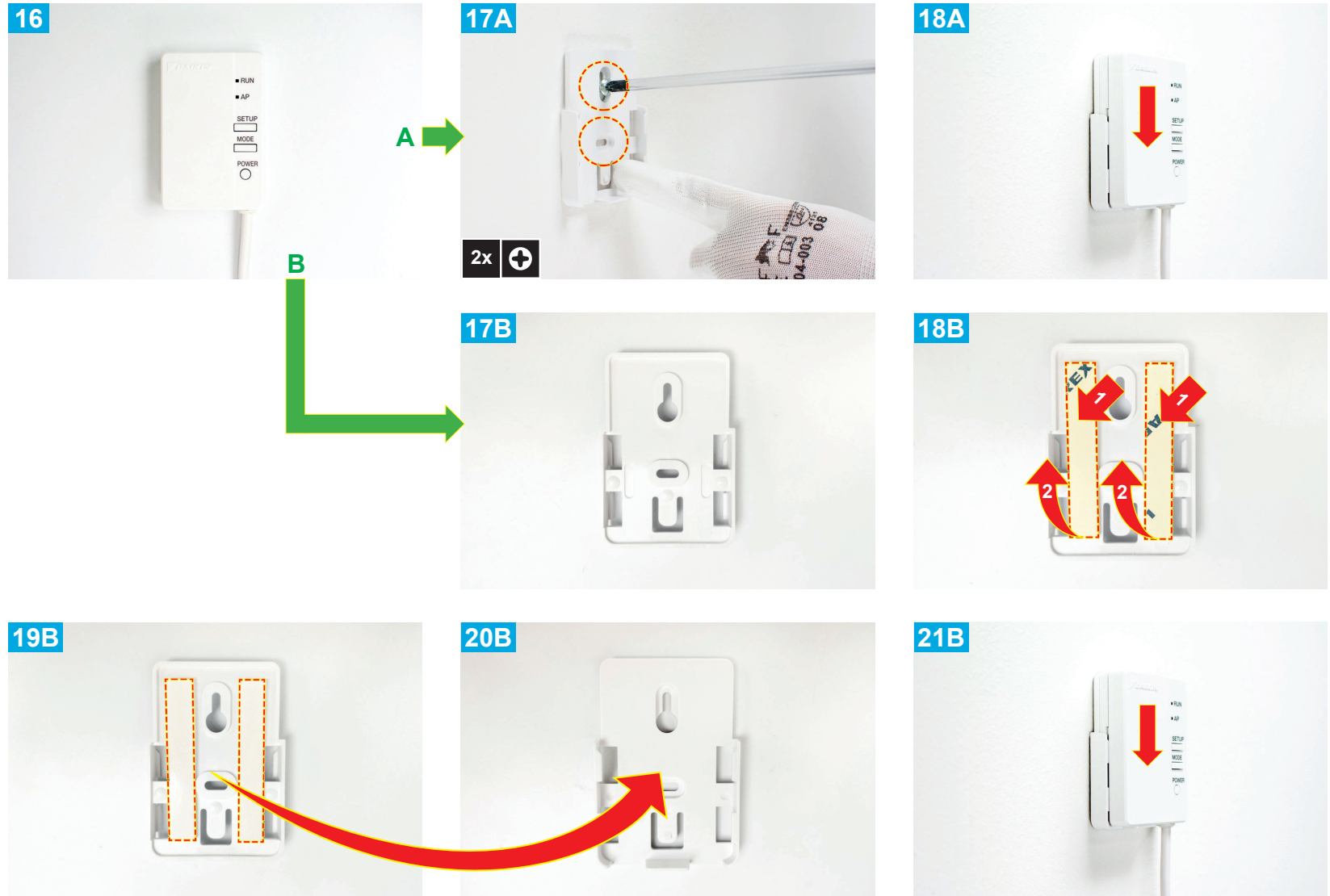

FTXS-K (35/42/50), FTXLS-K (25/35), FTXM-K (35/42/50), ATXS-K (35/50)

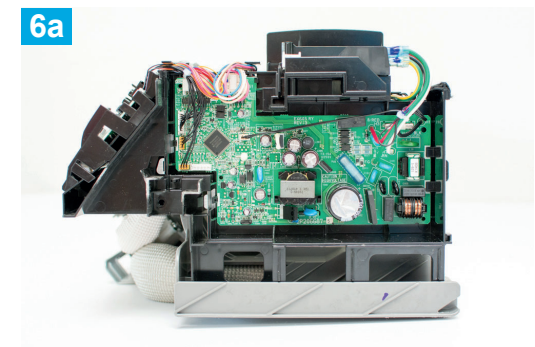
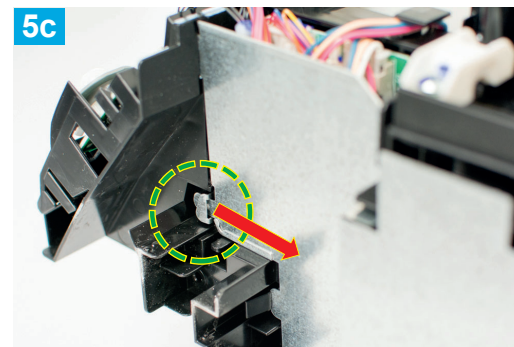
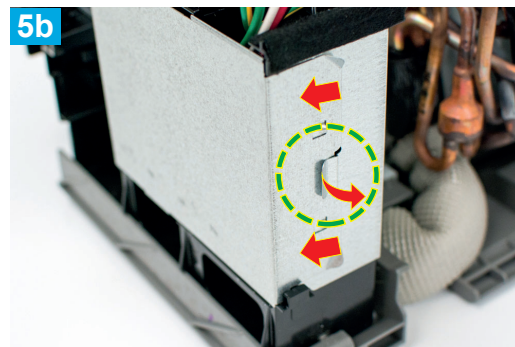
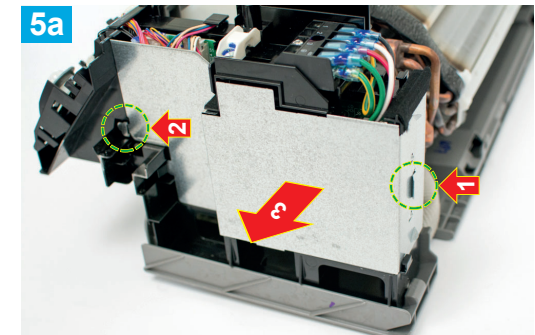
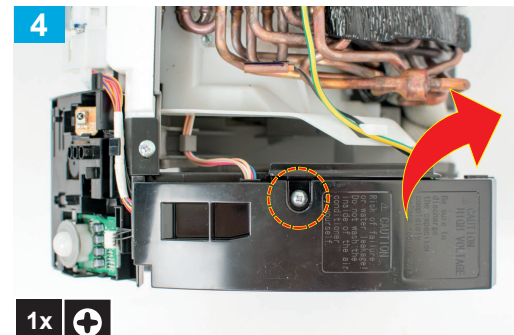
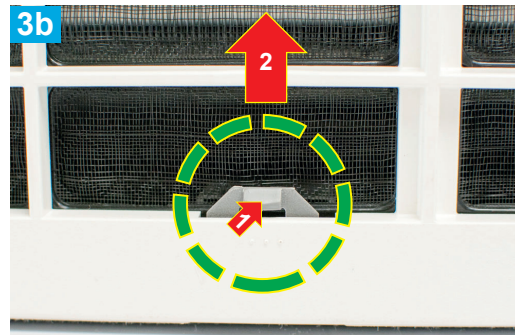
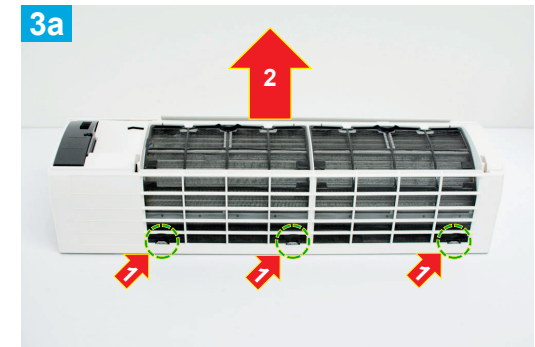
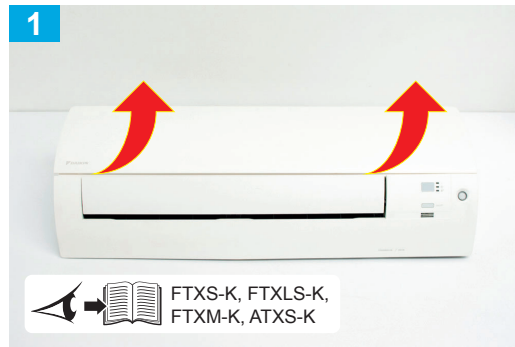
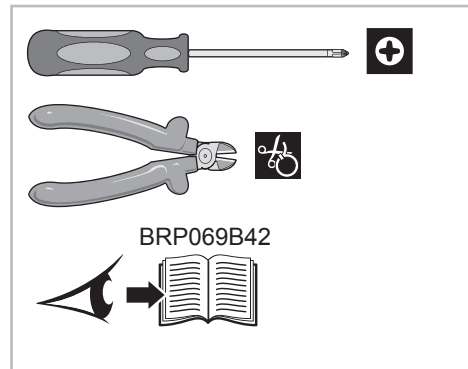
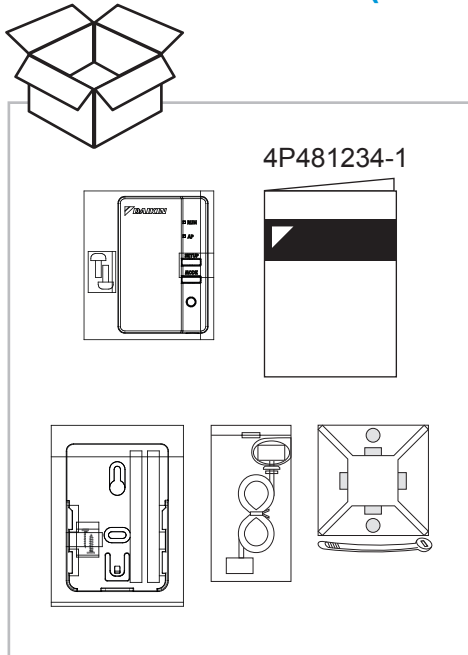

FTXS-K (35/42/50), FTXLS-K (25/35), FTXM-K (35/42/50), ATXS-K (35/50)

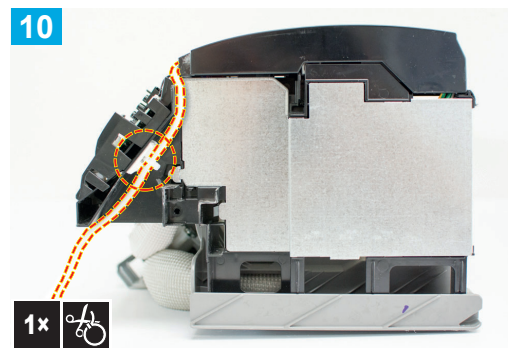
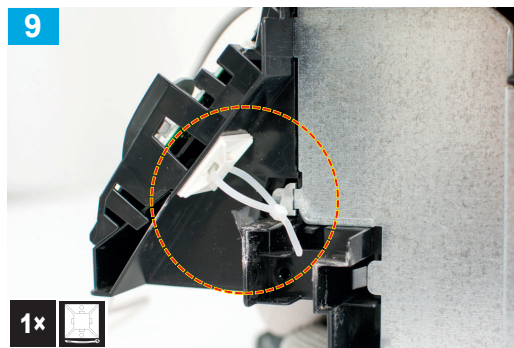
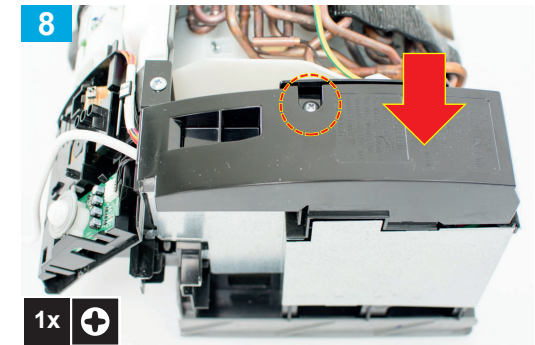
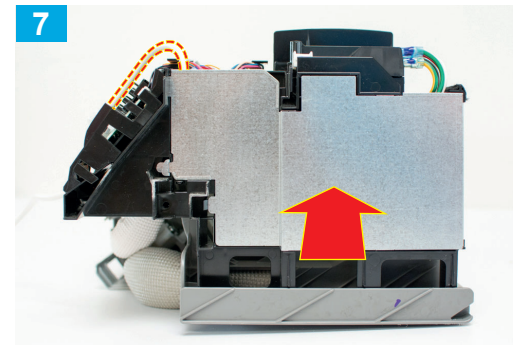
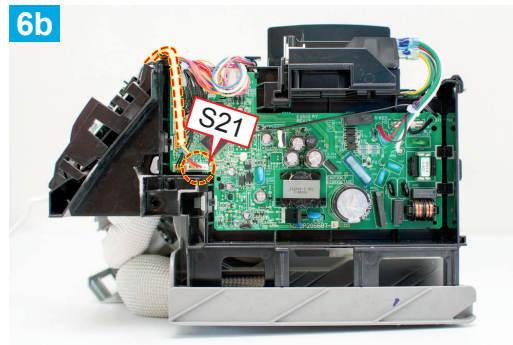

... 4 → 1 ...

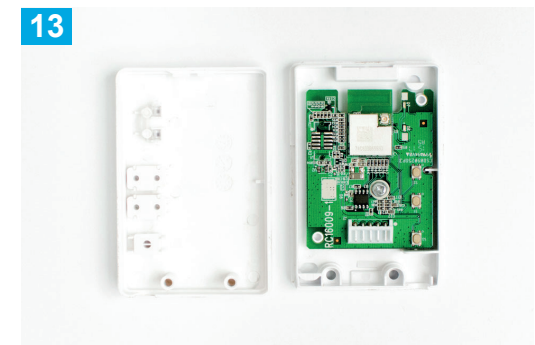
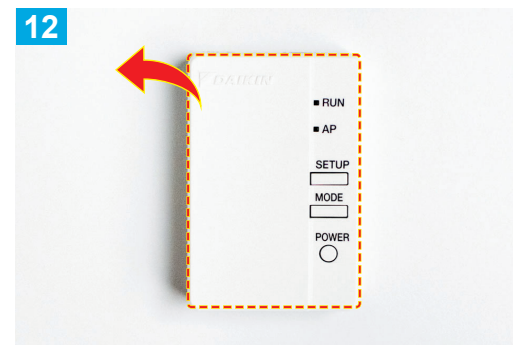
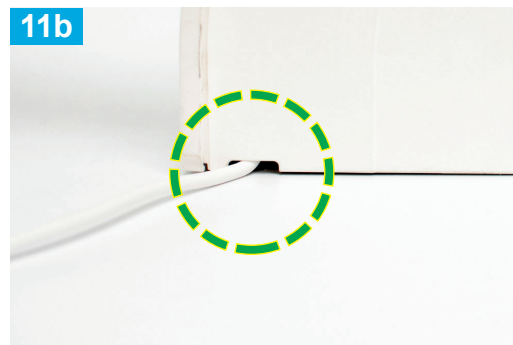

FTXS-K (35/42/50), FTXLS-K (25/35), FTXM-K (35/42/50), ATXS-K (35/50)

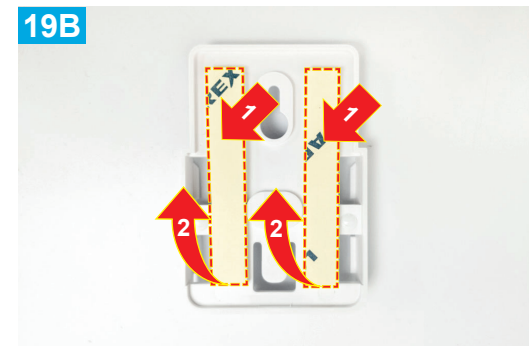
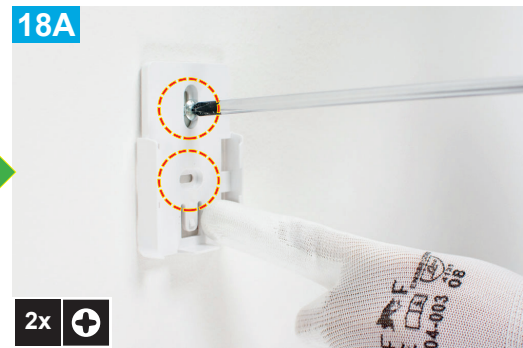
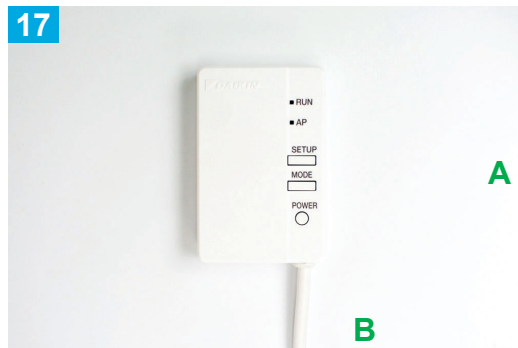
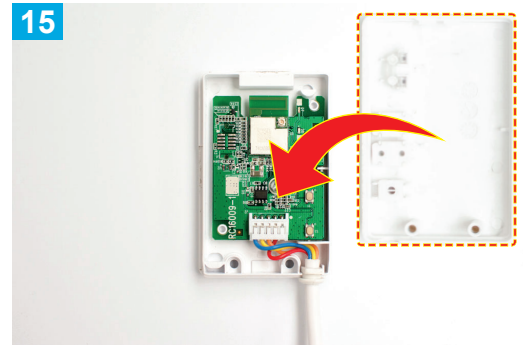
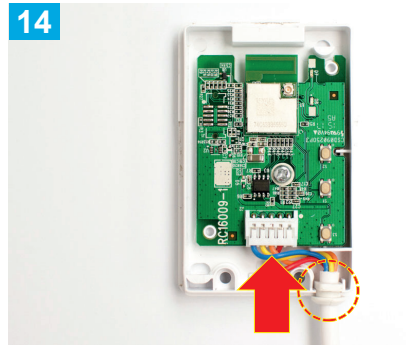

FTXS-K (35/42/50), FTXLS-K (25/35), FTXM-K (35/42/50), ATXS-K (35/50)

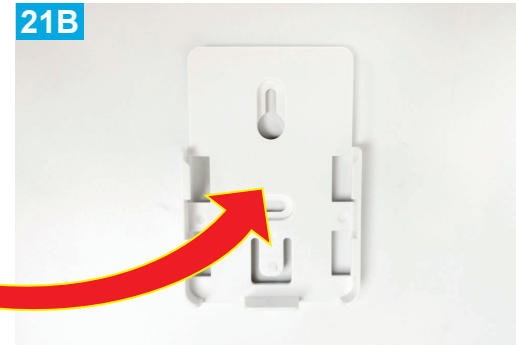
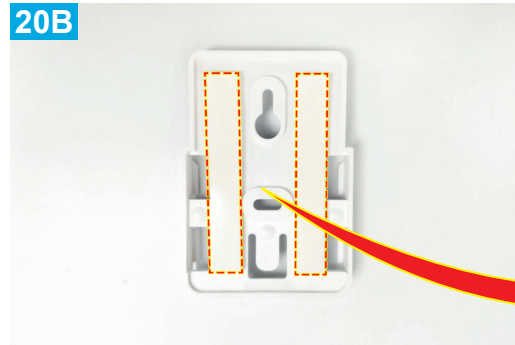

FTXS-G (60/71)

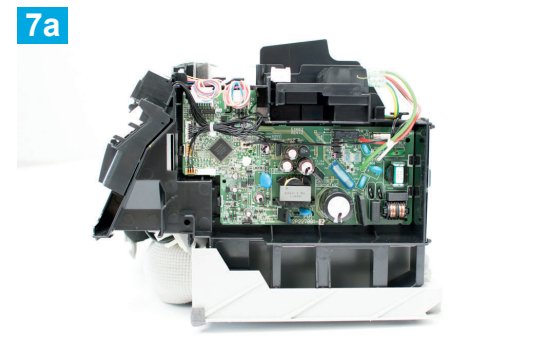
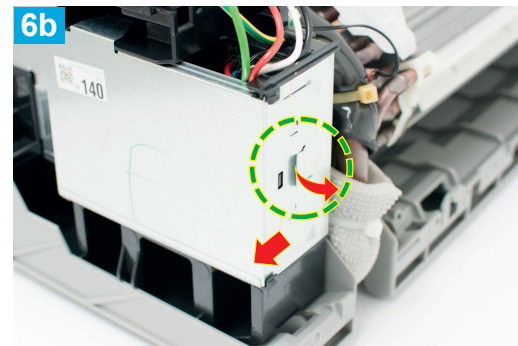
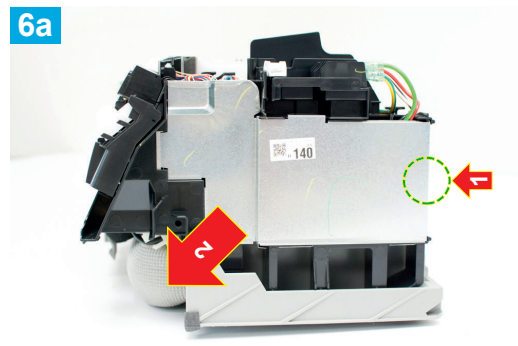
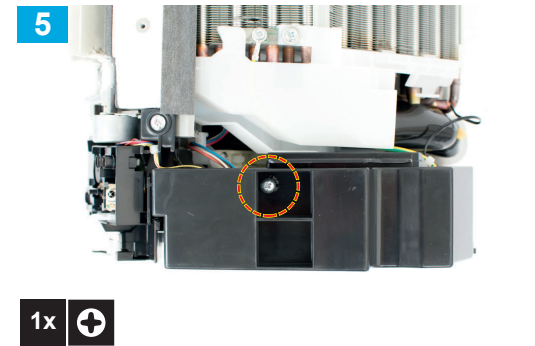
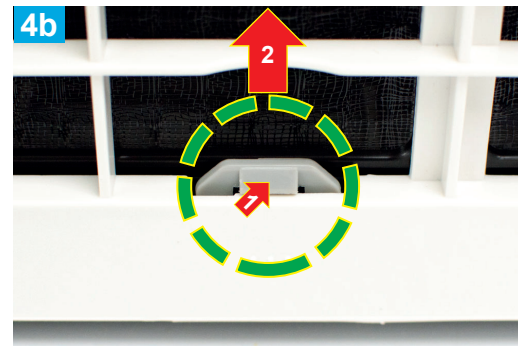
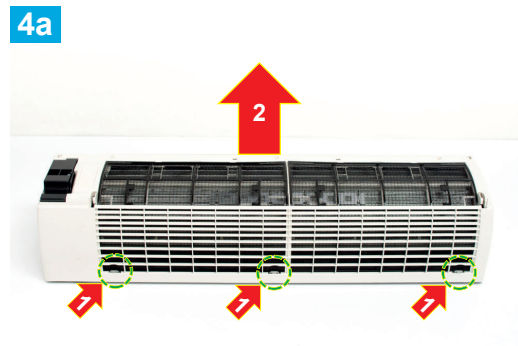
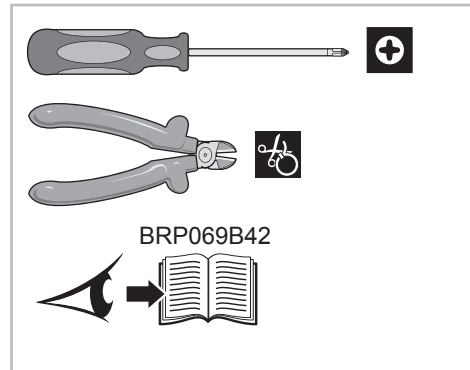
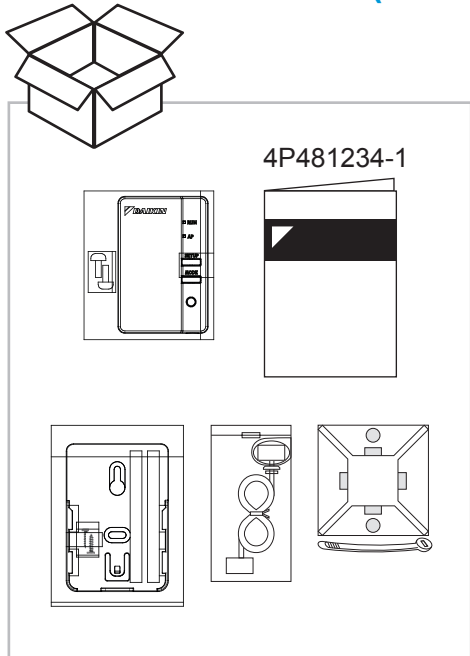

FTXS-G (60/71)

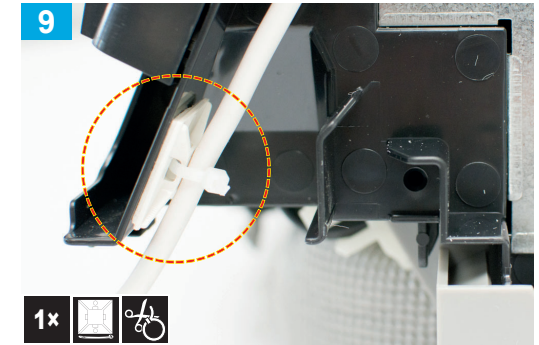
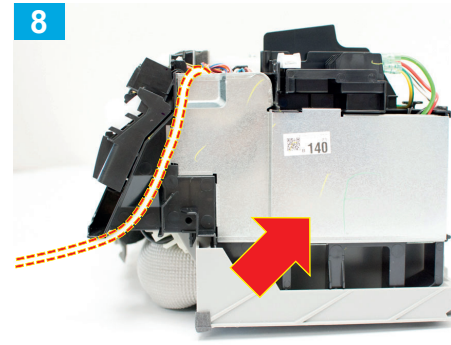
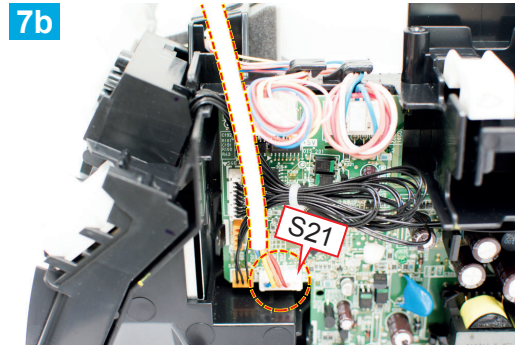

... 6 → 1 ...

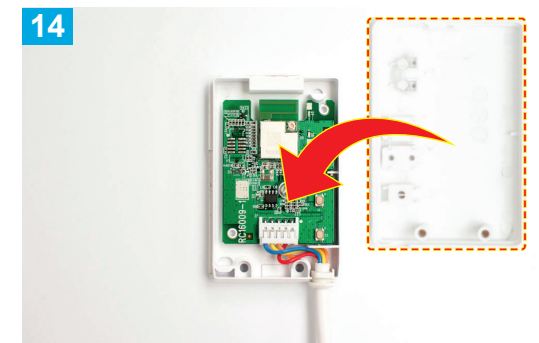
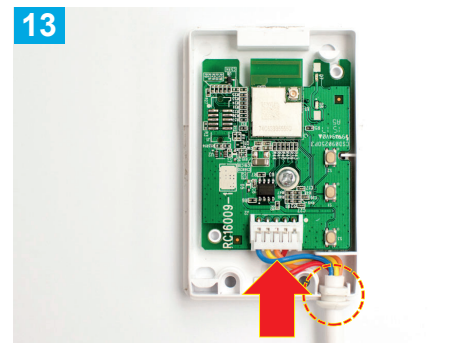
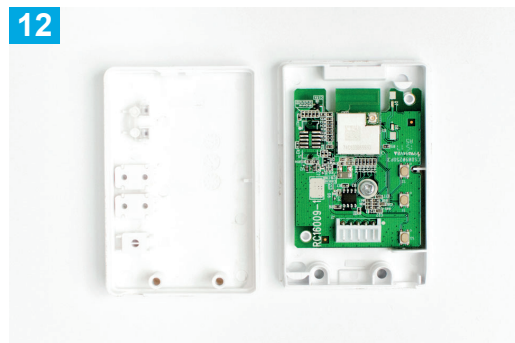
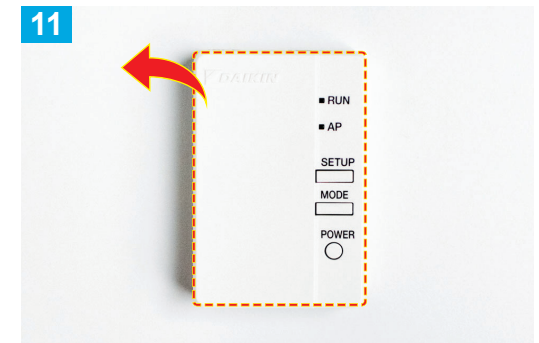

FTXS-G (60/71)

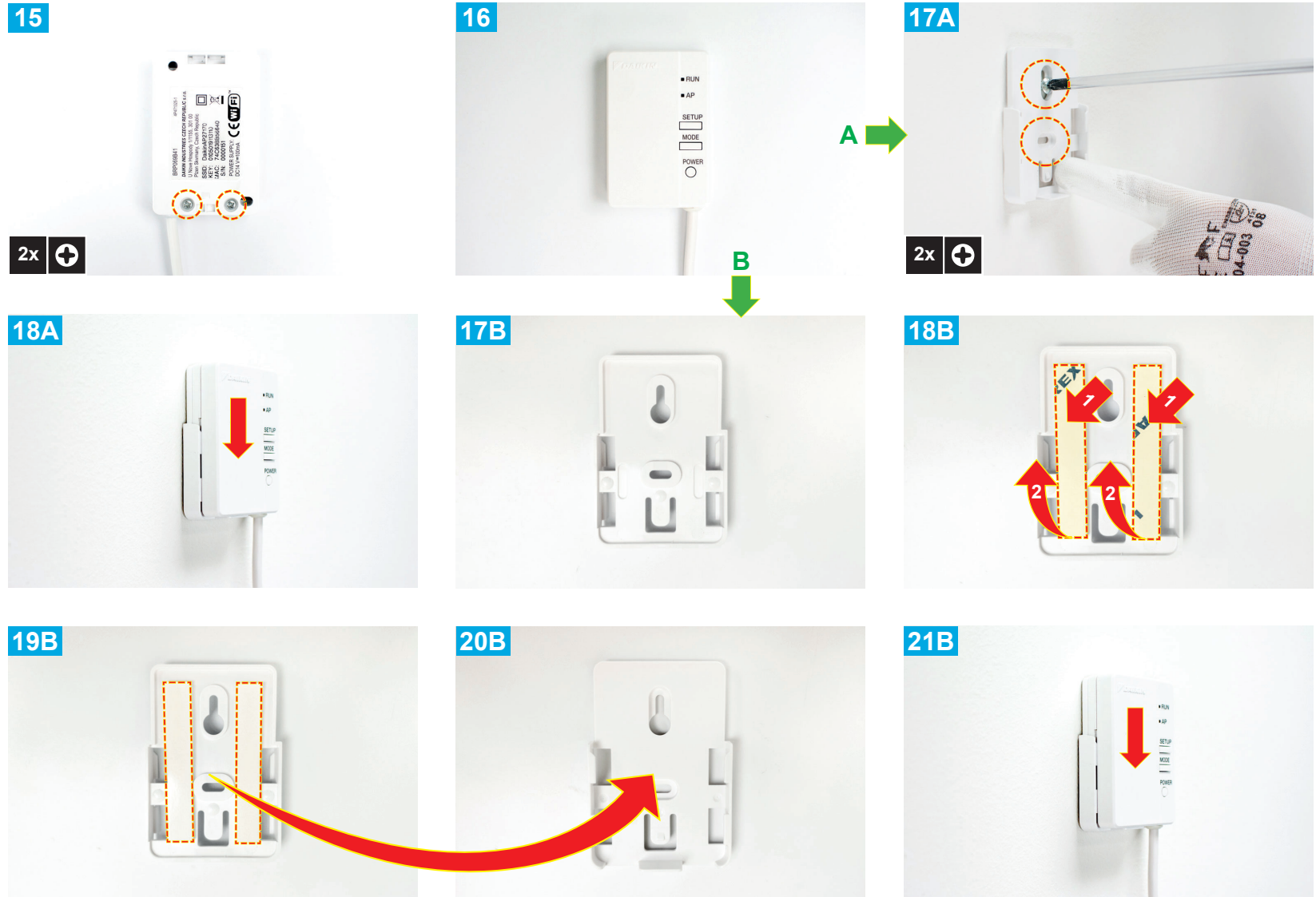

FTX-G (60/71)

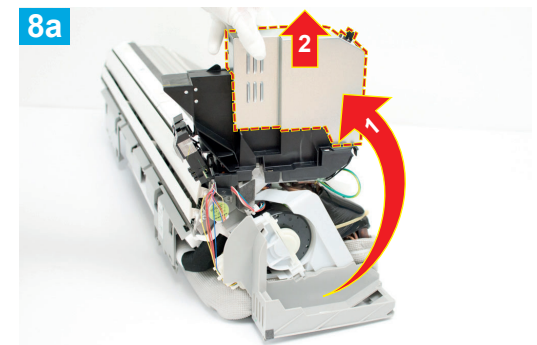
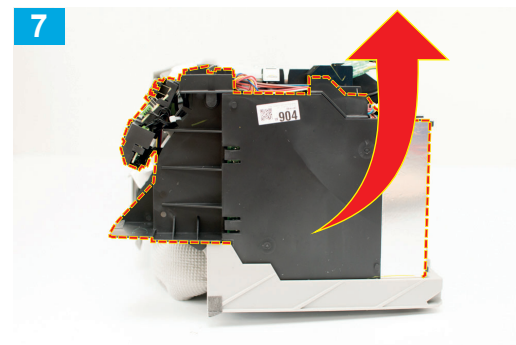
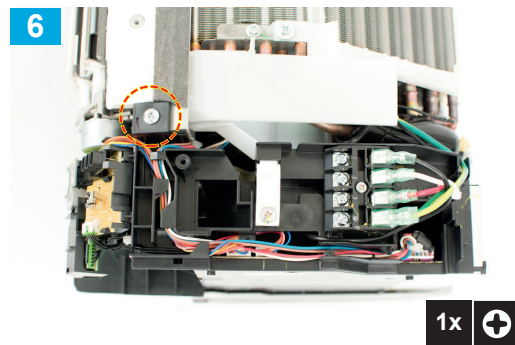
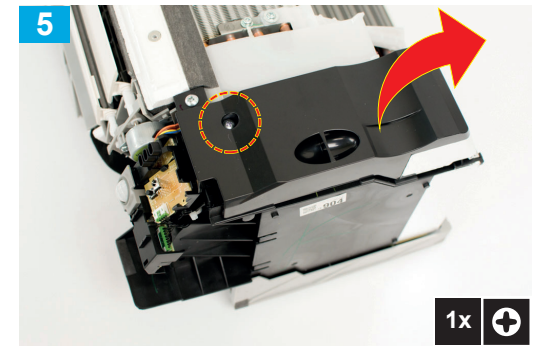
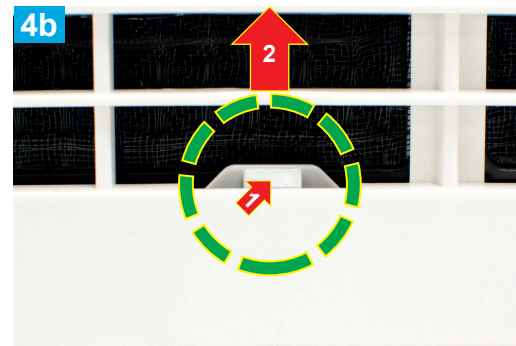
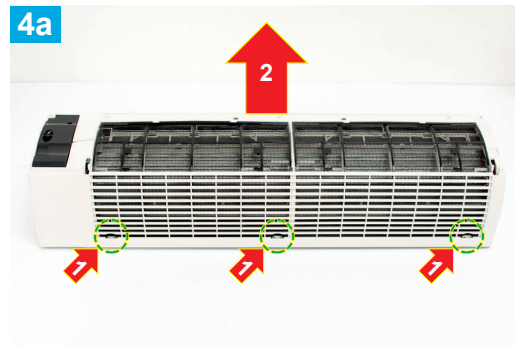
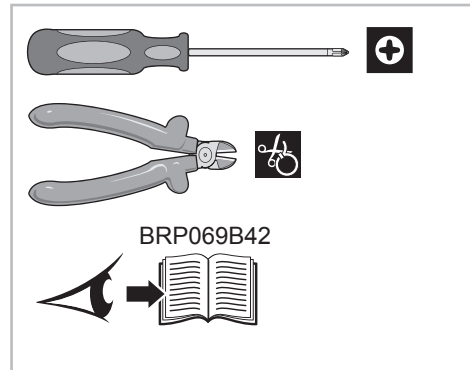
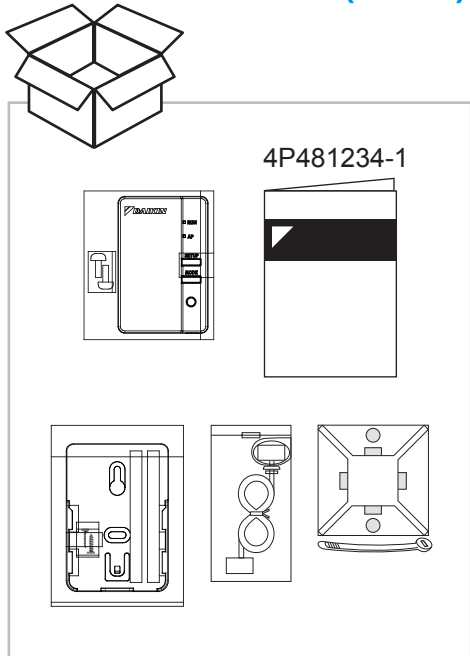

FTX-G (60/71)

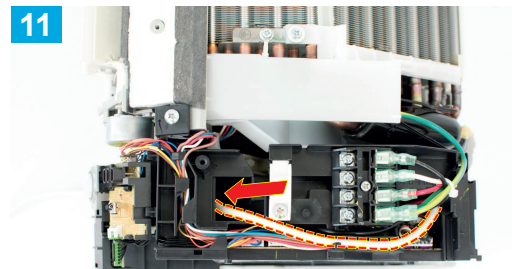
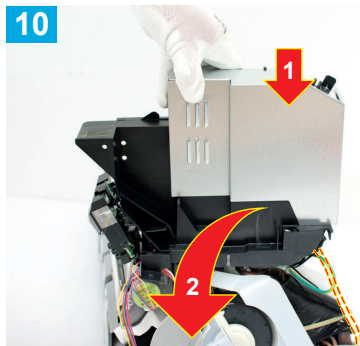
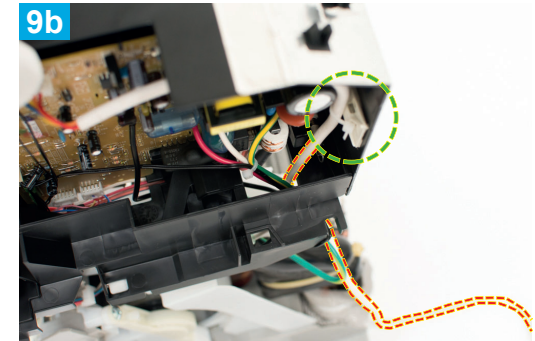
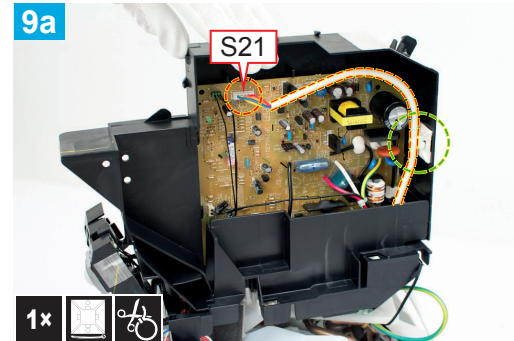
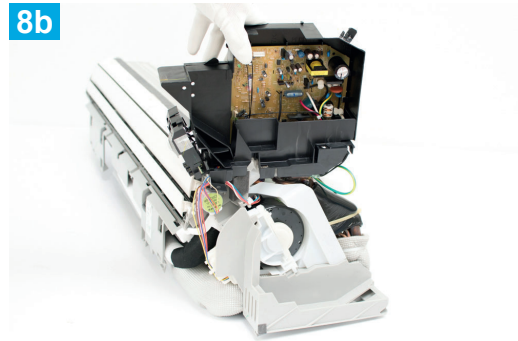

... 5 → 1 ...

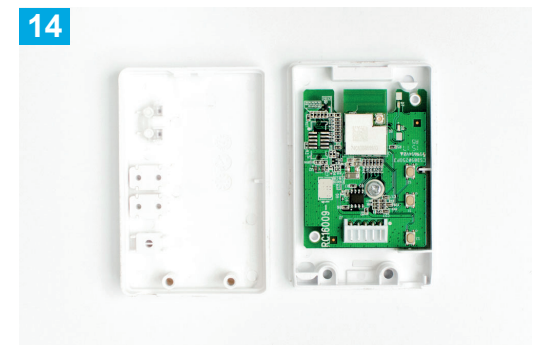
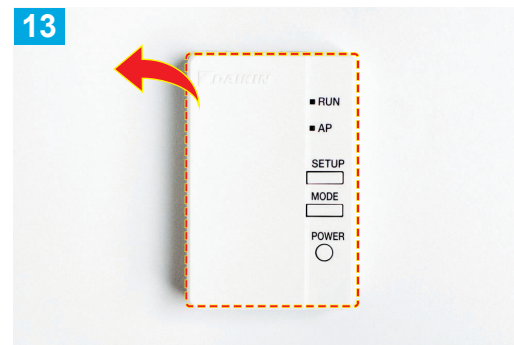

FTX-G (60/71)

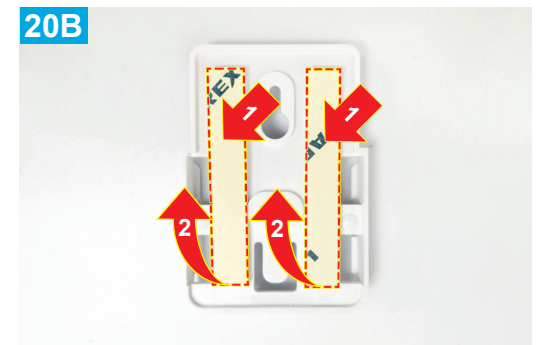
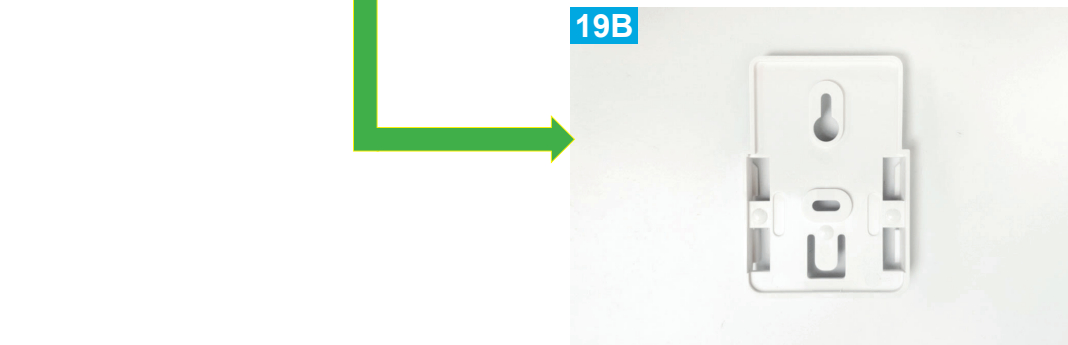
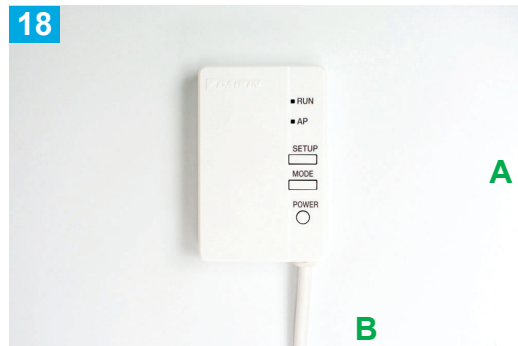
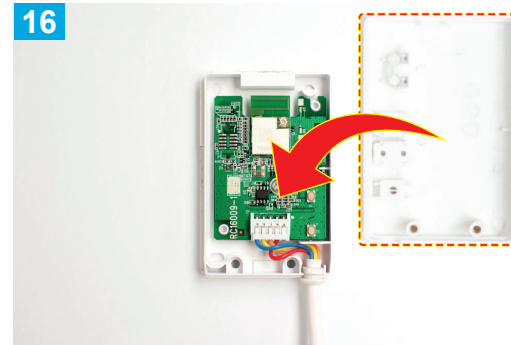
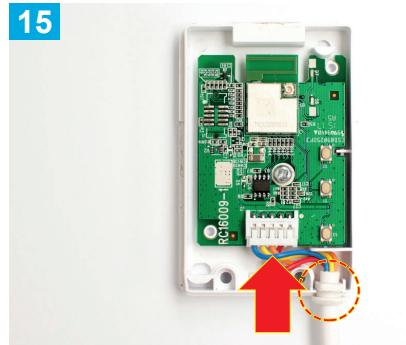

FTX-G (60/71)

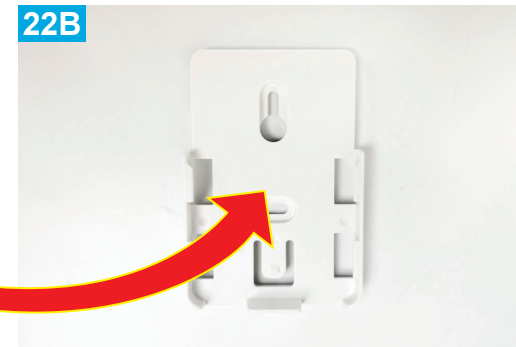
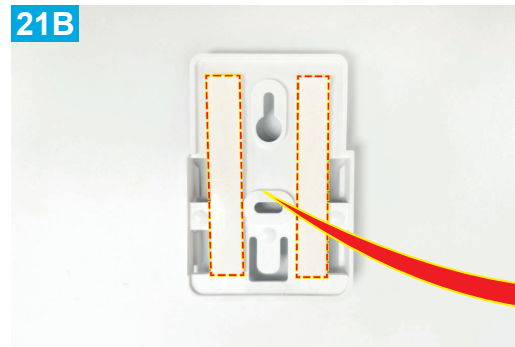

FVXG-K (25/35/50)

4P481234-1

BRP069B42

Tools: Screwdriver, Pliers, and a wheelchair icon.

Icons: A plus sign in a square and a book icon with an arrow.

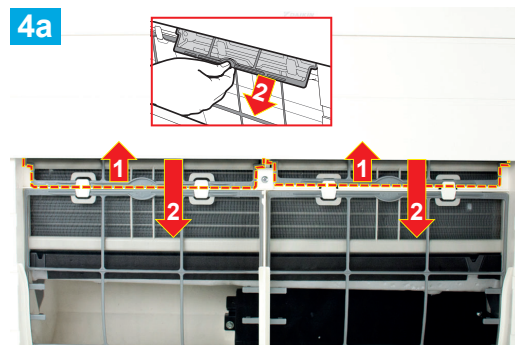
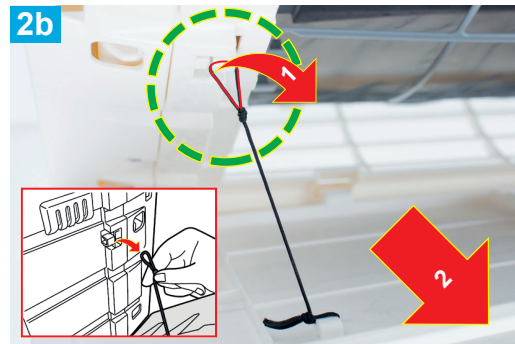

FVXG-K (25/35/50)

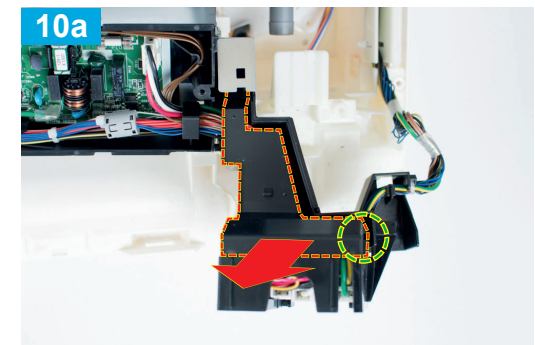
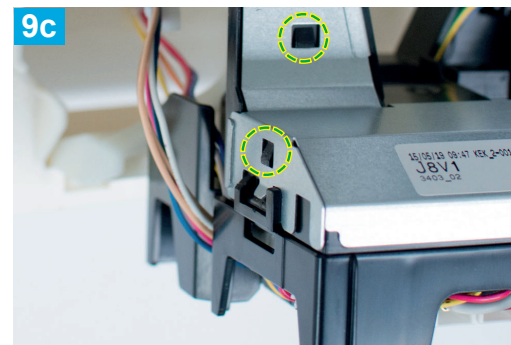
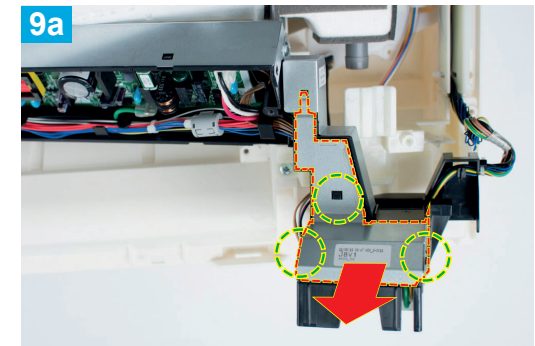
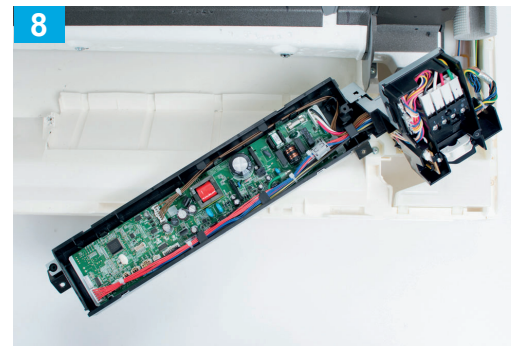
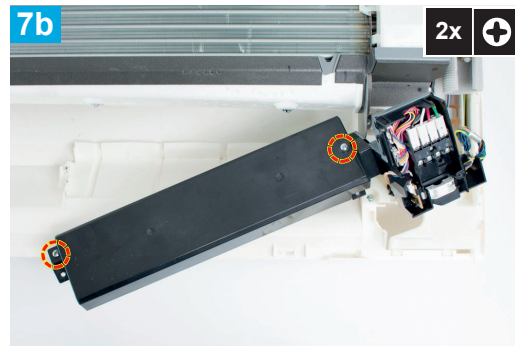
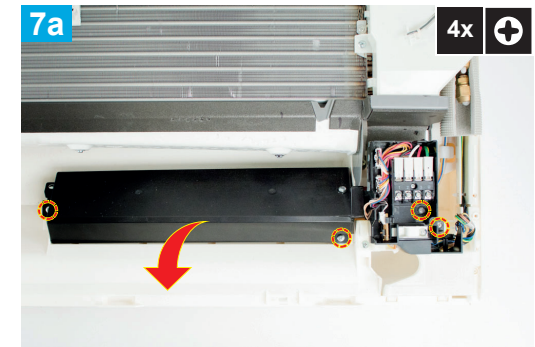
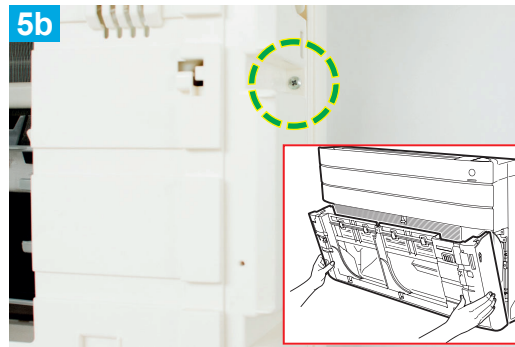

FVXG-K (25/35/50)

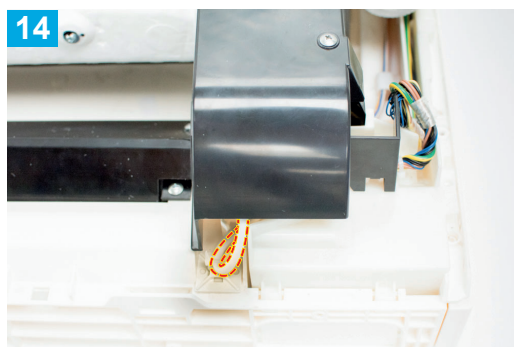
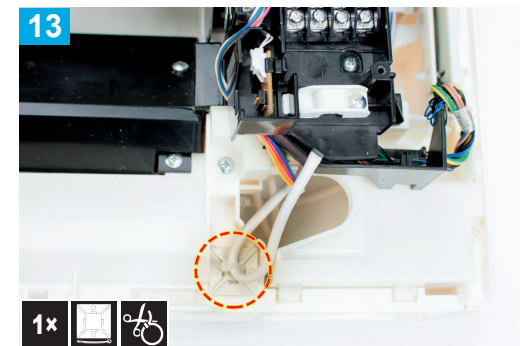
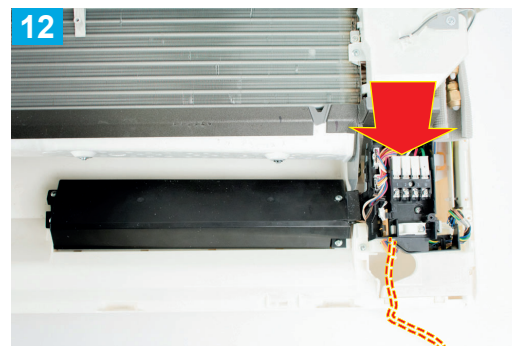
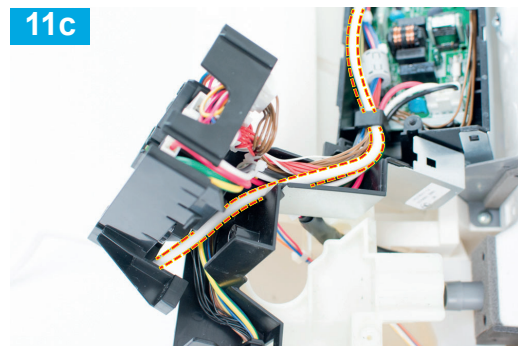
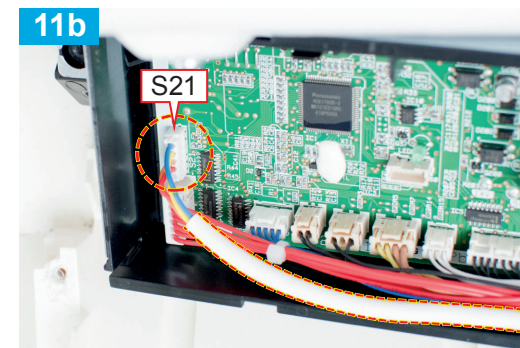
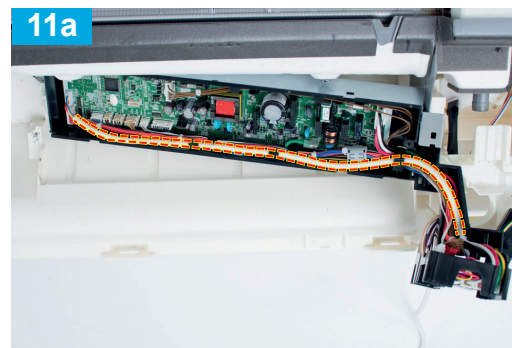
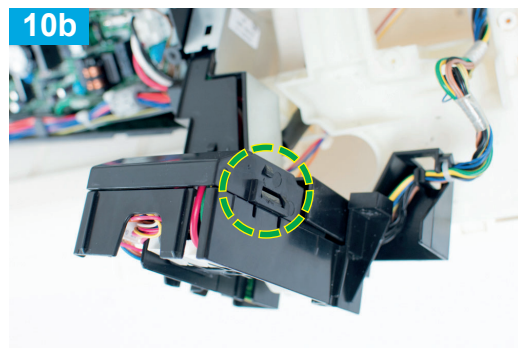

... 5 → 1 ...



FVXG-K (25/35/50)

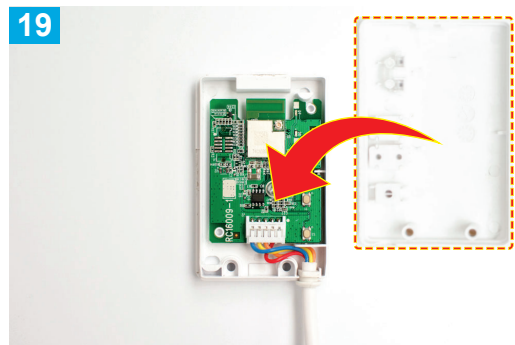
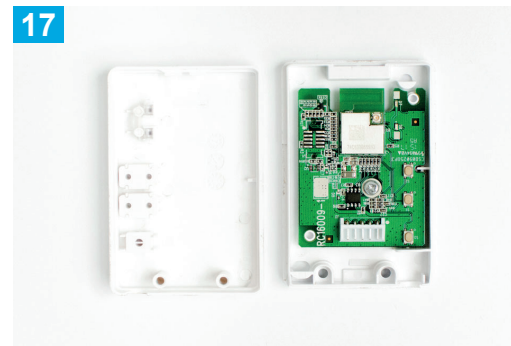
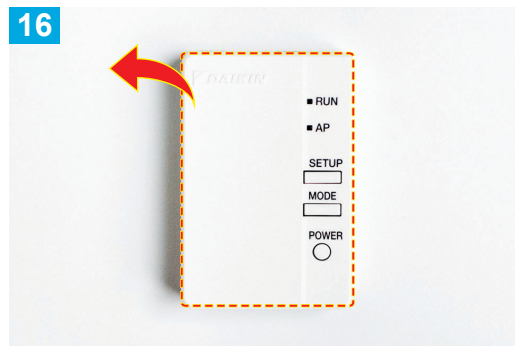

FVXG-K (25/35/50)

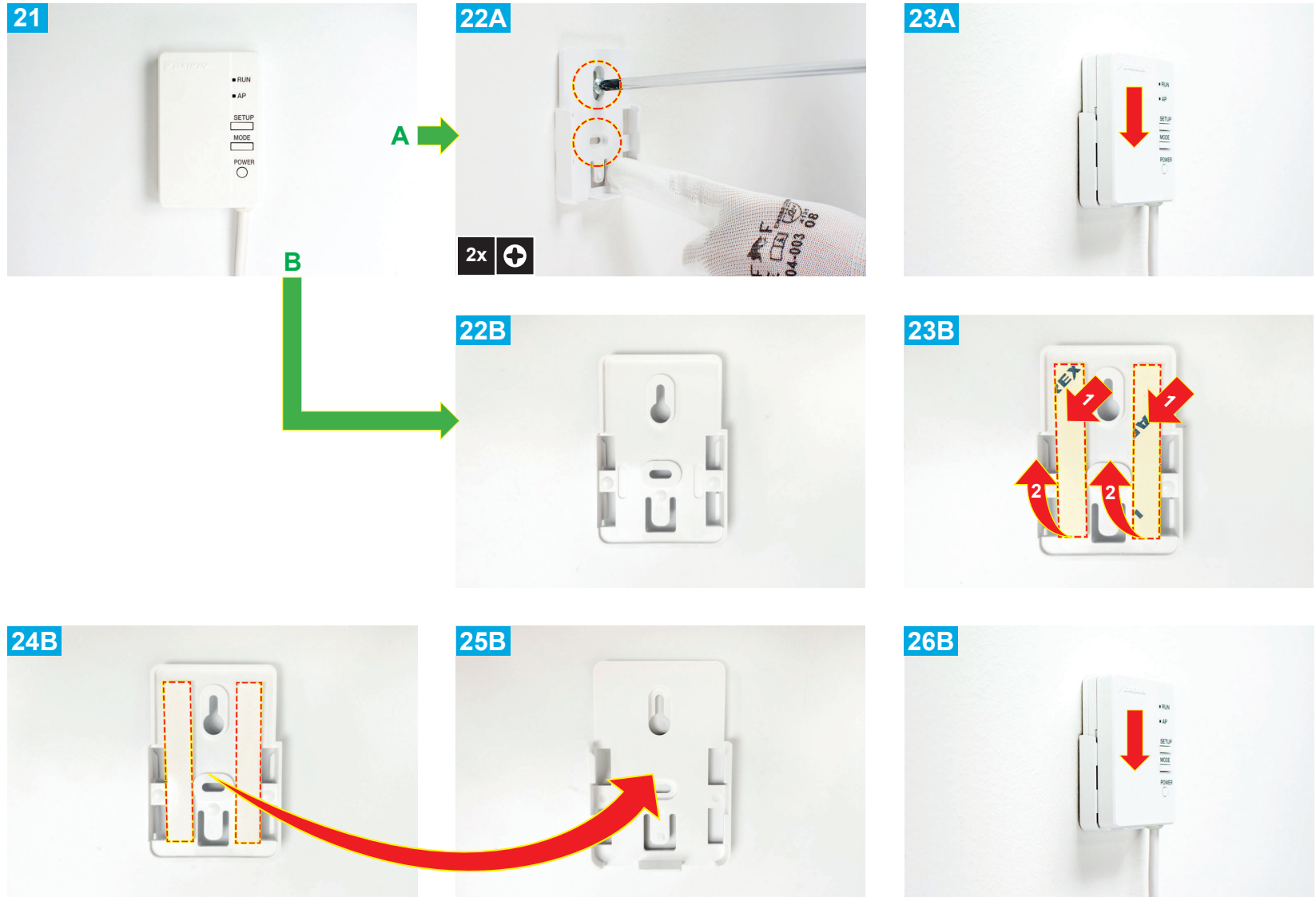

FVXS-F (25/35/50), FVXM-F (25/35/50)

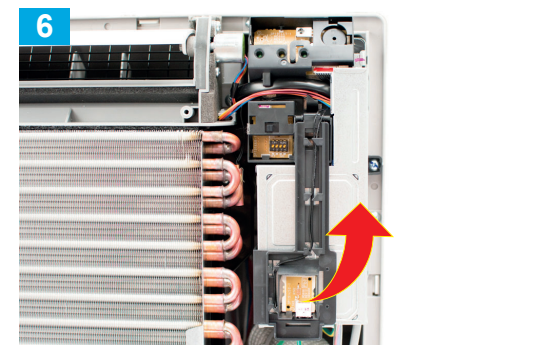
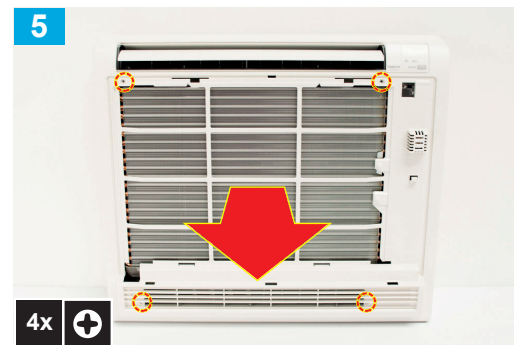
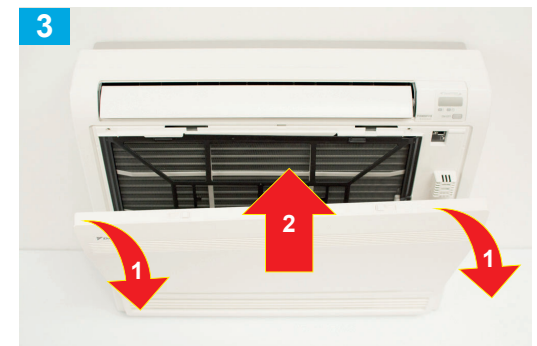
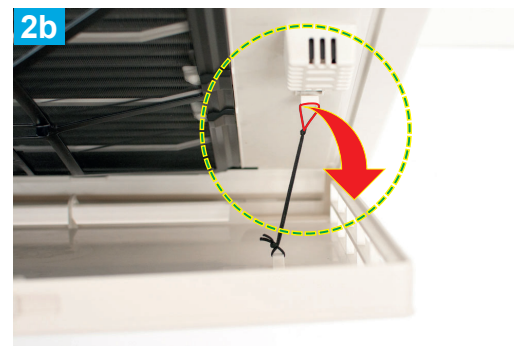
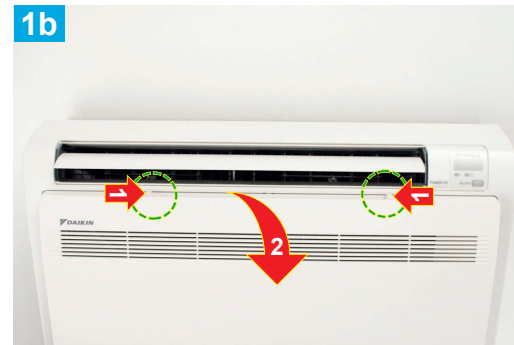
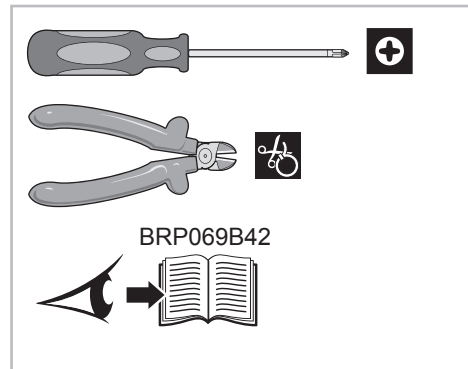
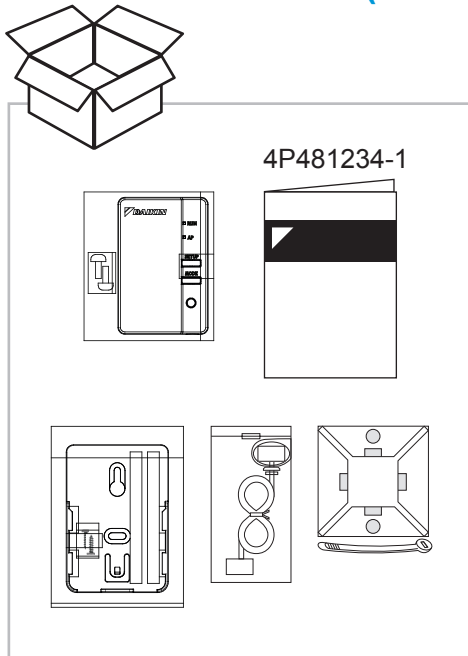

FVXS-F (25/35/50), FVXM-F (25/35/50)

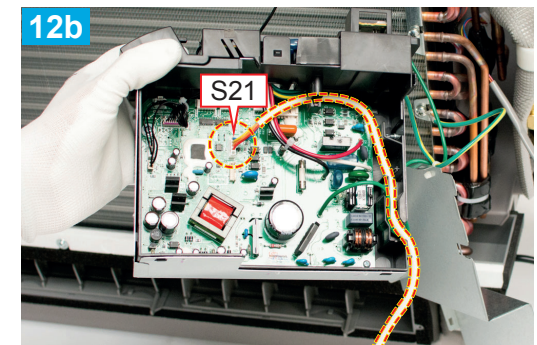
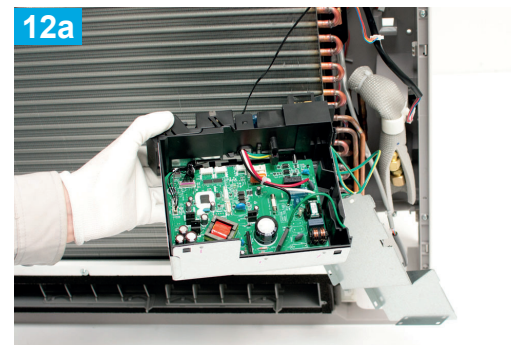
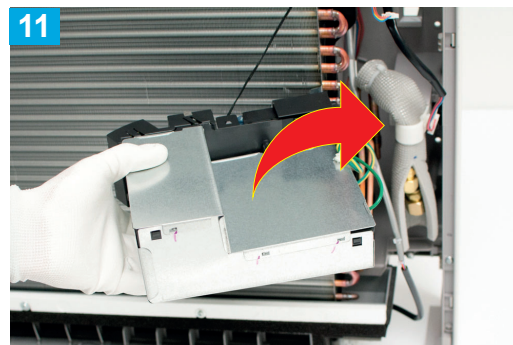
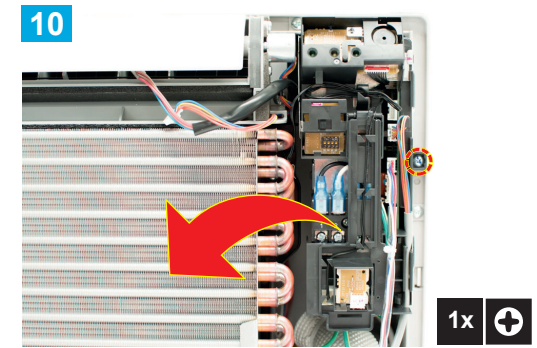
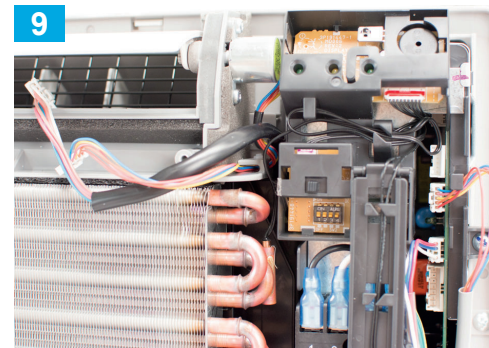
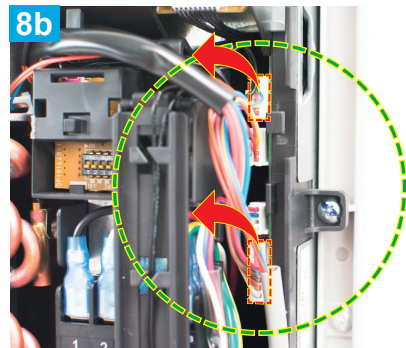
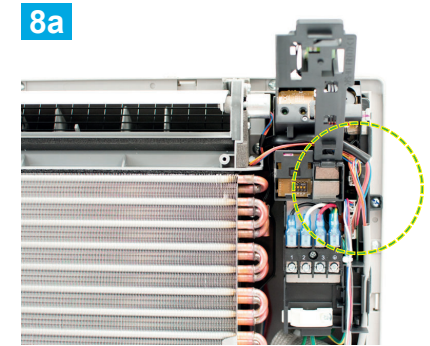
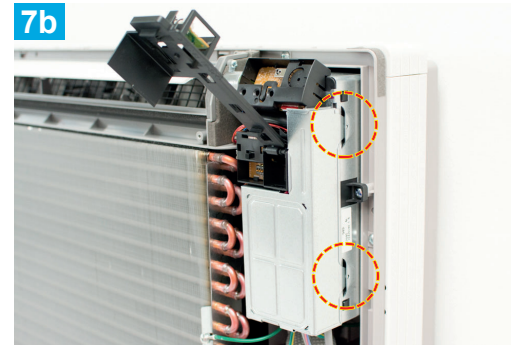
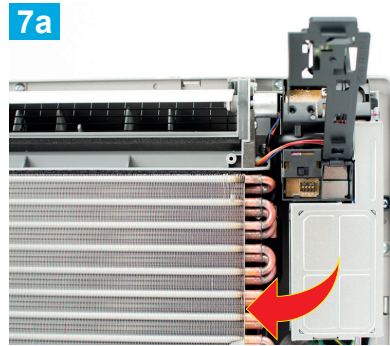

FVXS-F (25/35/50), FVXM-F (25/35/50)

... 11 → 6 ... 13

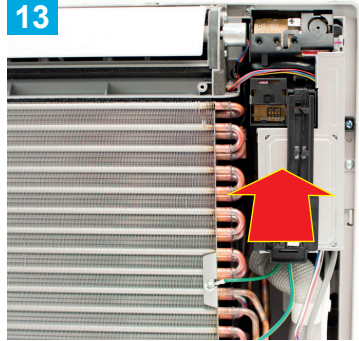

14

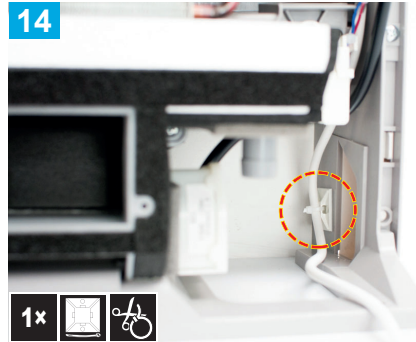

... 5 → 1 ... 15



16

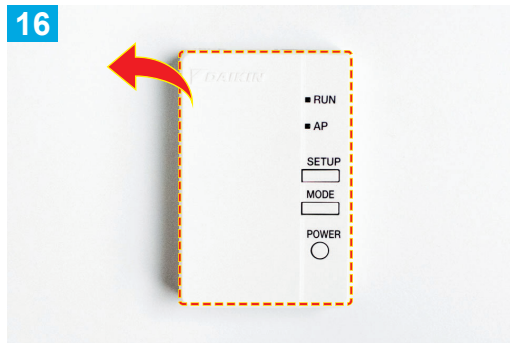

17

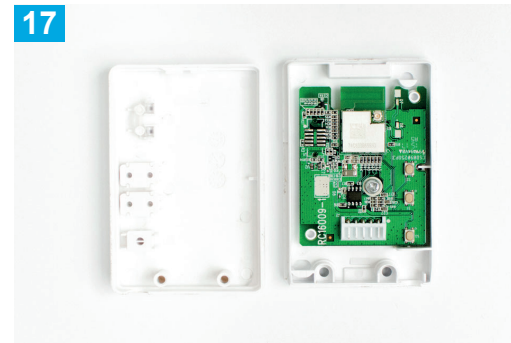

18



19

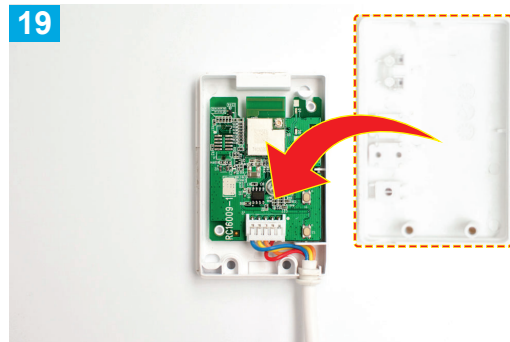

20



FVXS-F (25/35/50), FVXM-F (25/35/50)

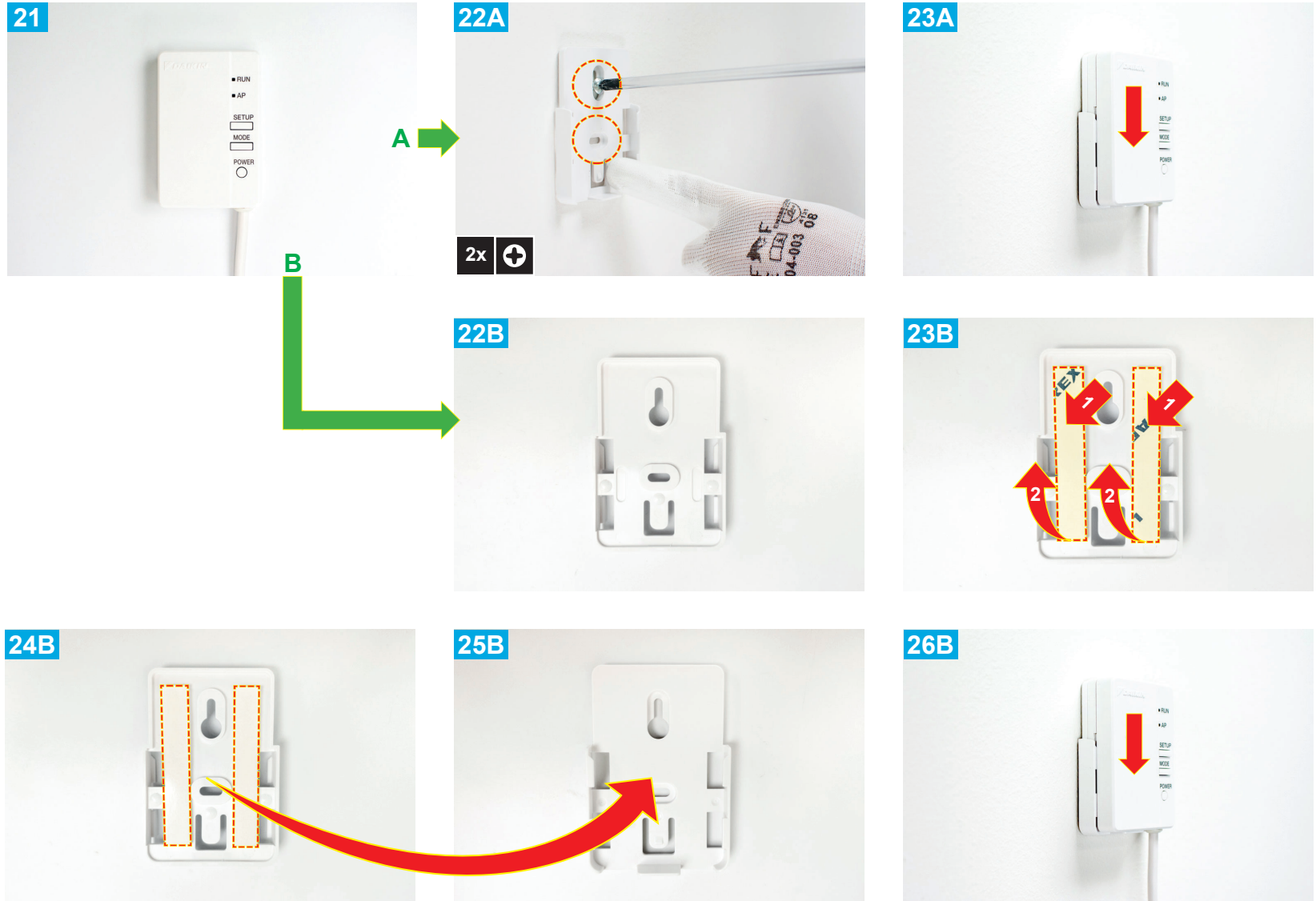

FLXS-B(9) (25/35/50)

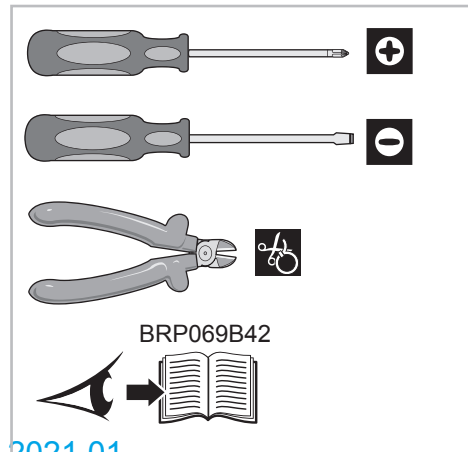
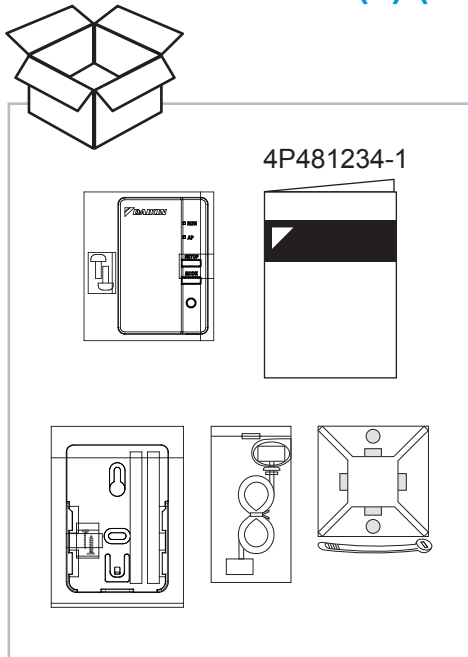

2021.01

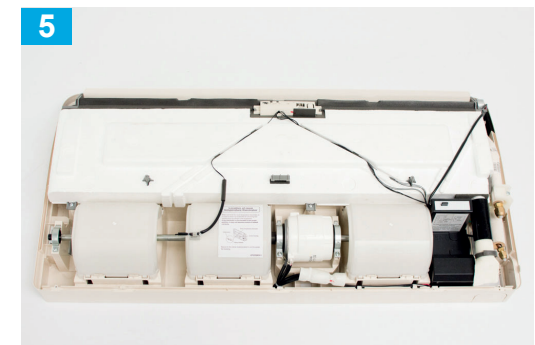
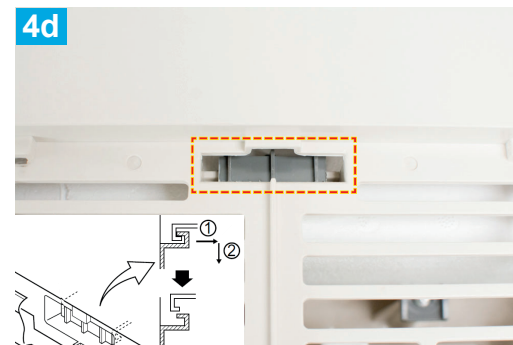
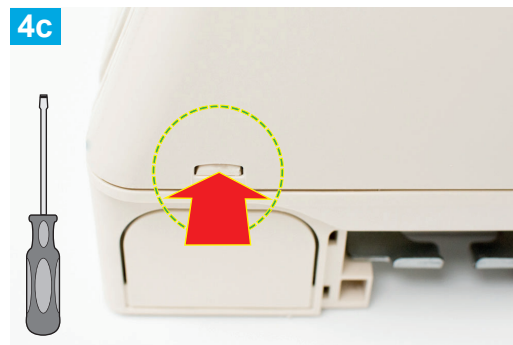
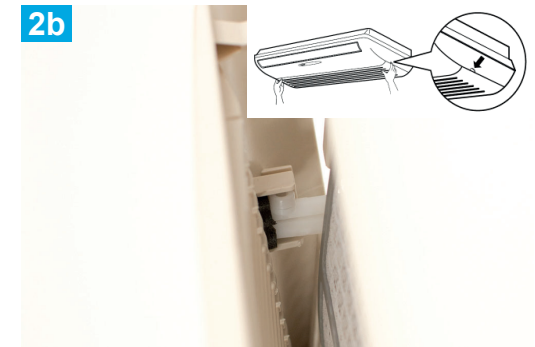
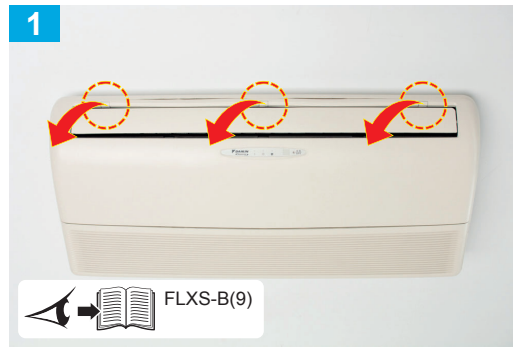

FLXS-B(9) (25/35/50)

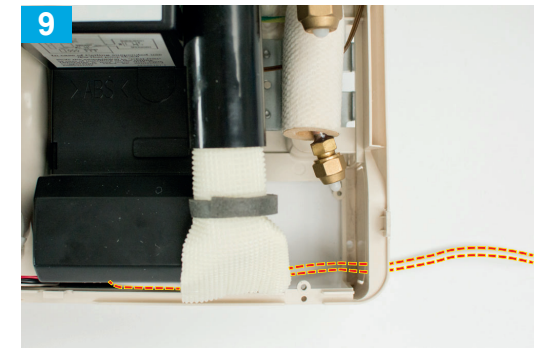
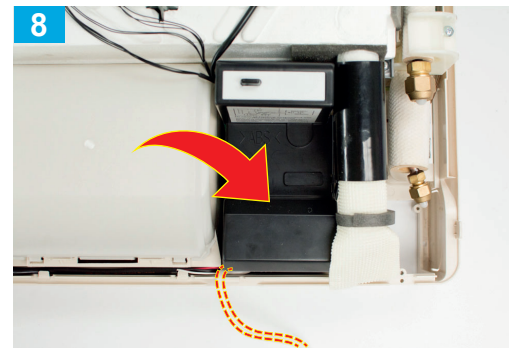
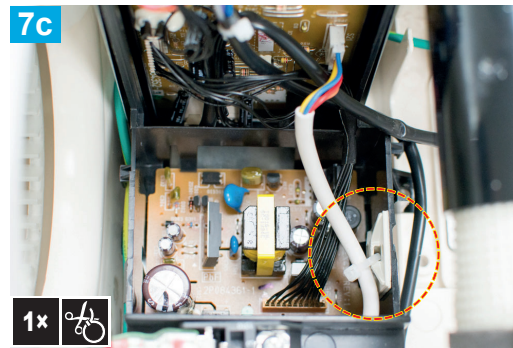
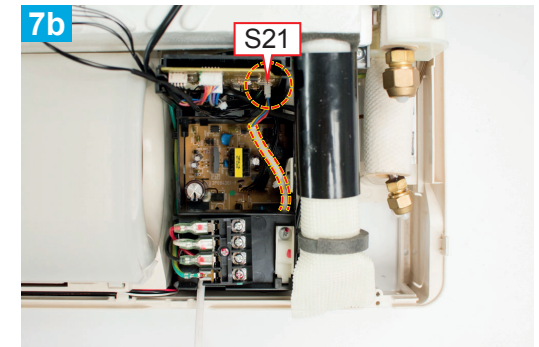
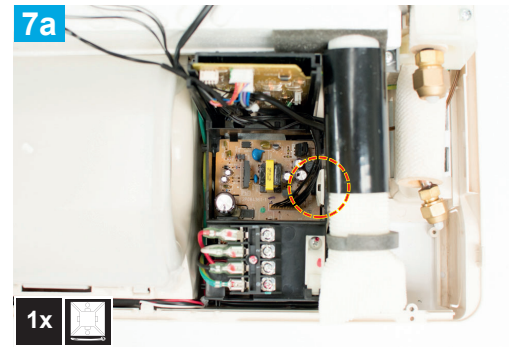

... 5 → 1 ...

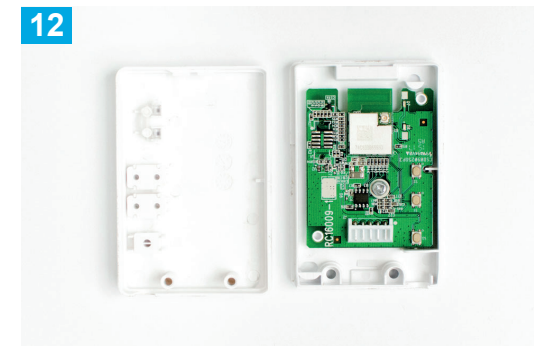
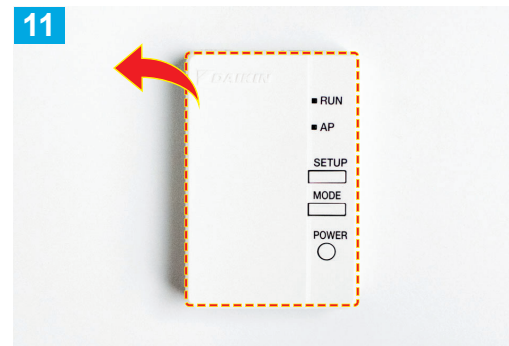

FLXS-B(9) (25/35/50)

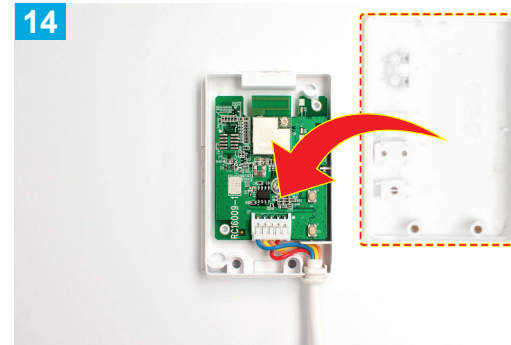
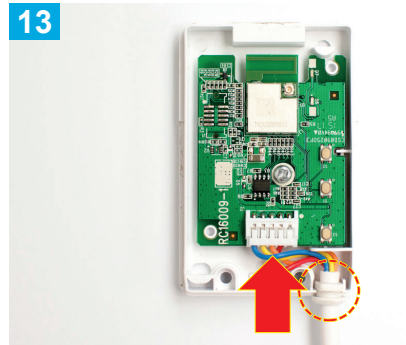

2x 

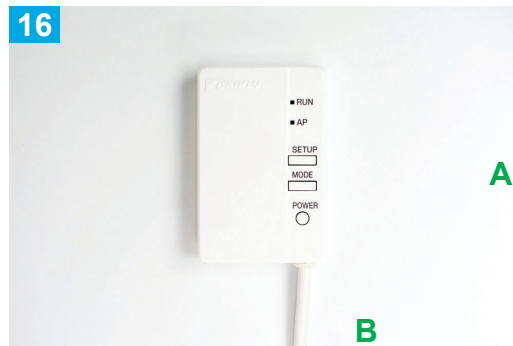

A 



2x 

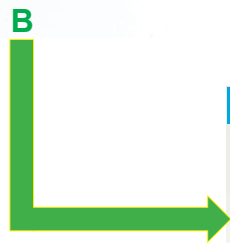

B 

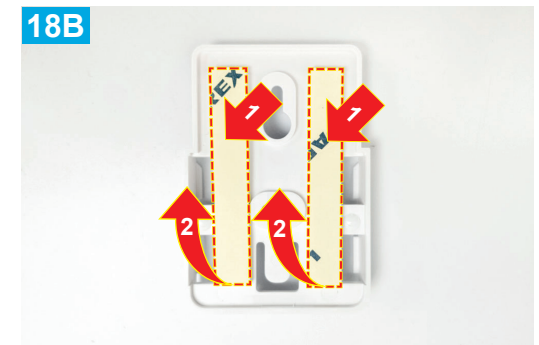

FLXS-B(9) (25/35/50)

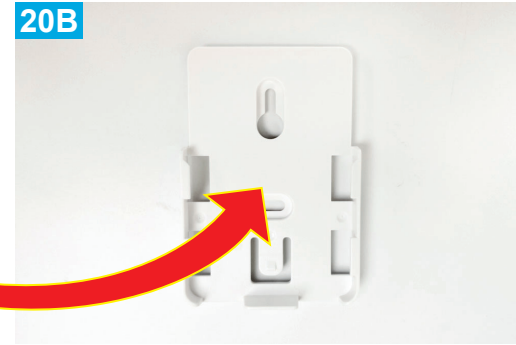
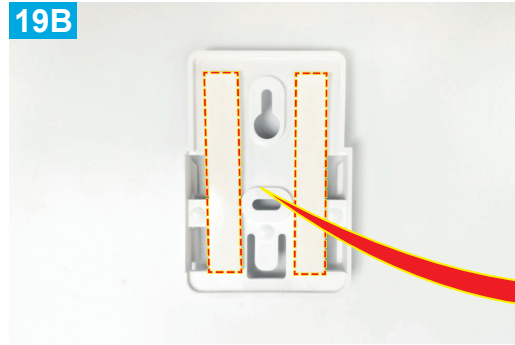

FTX-KN (25/35)

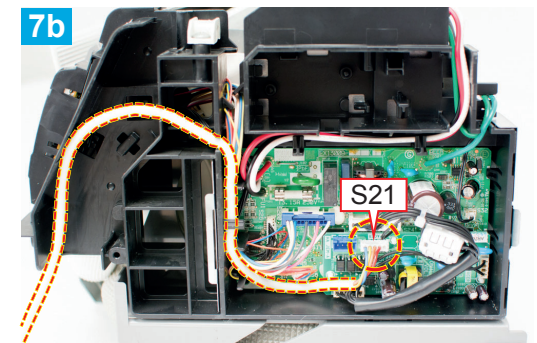
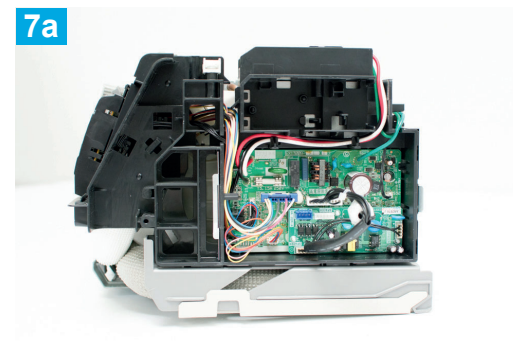
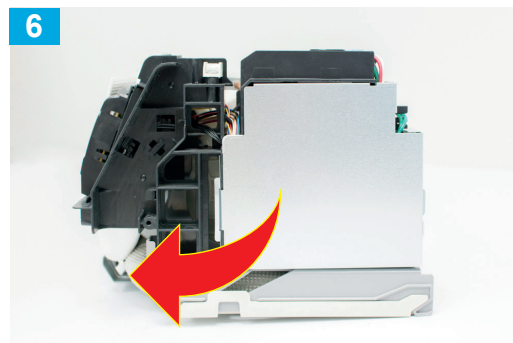
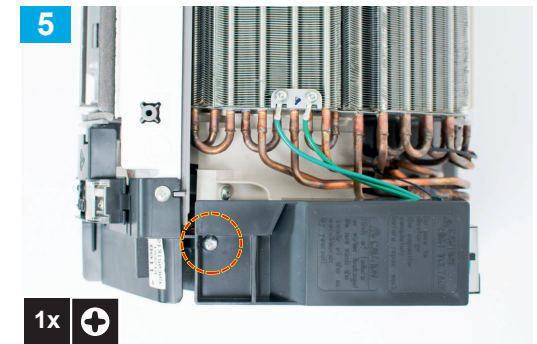
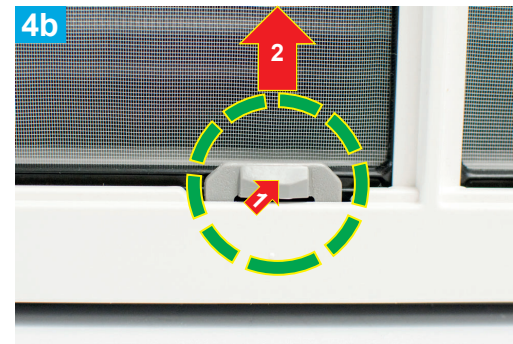
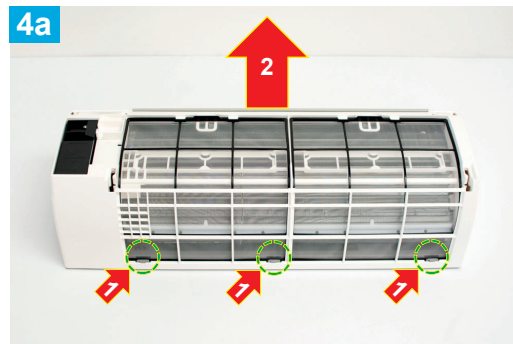
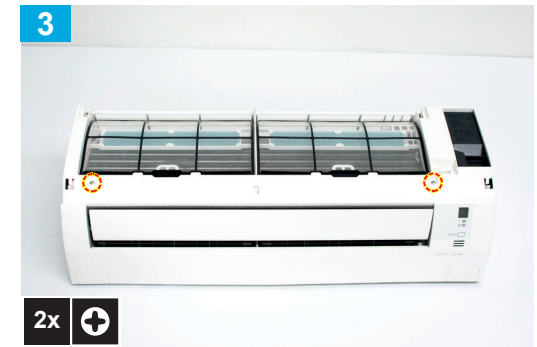
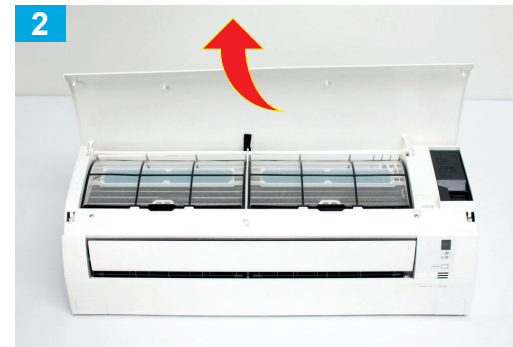
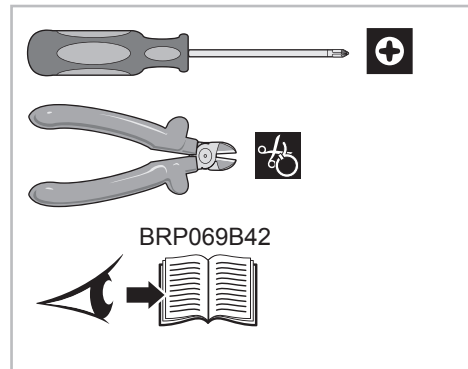
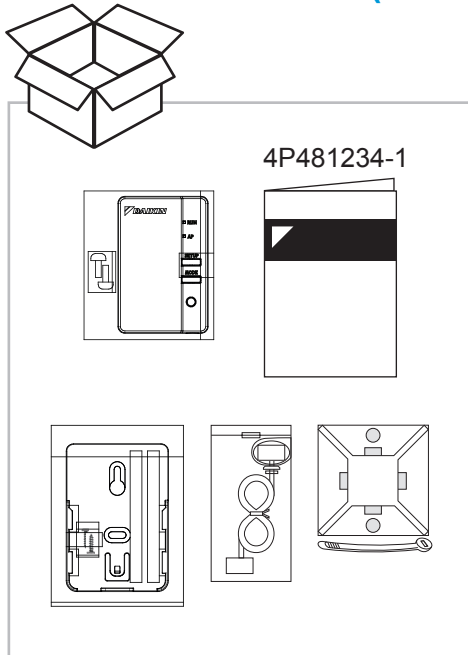

FTX-KN (25/35)

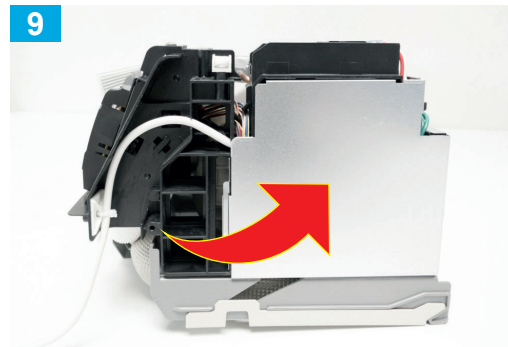
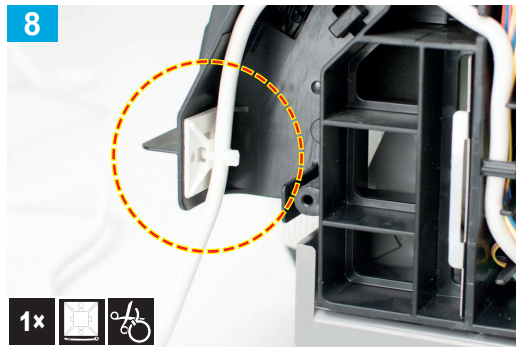

... **5** → **1** ...

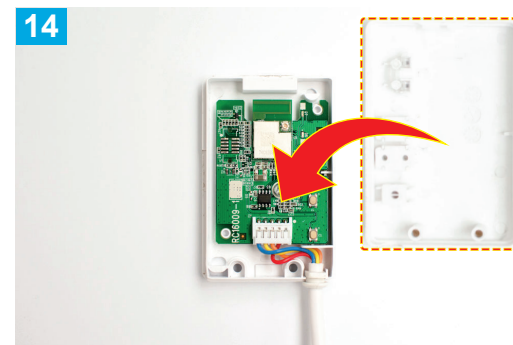
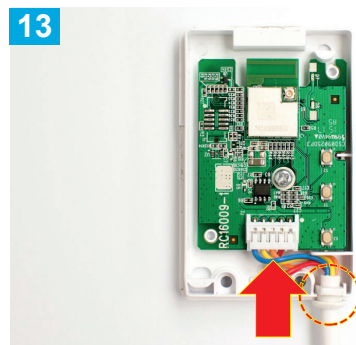
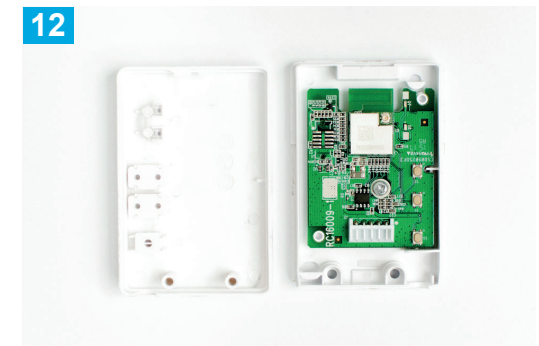
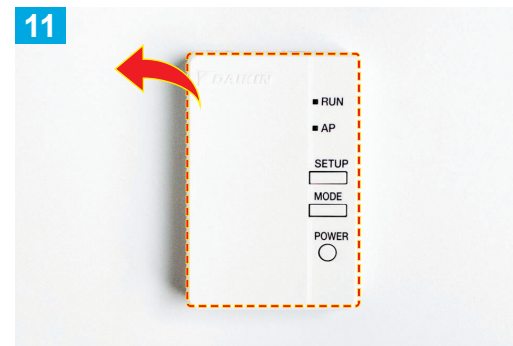
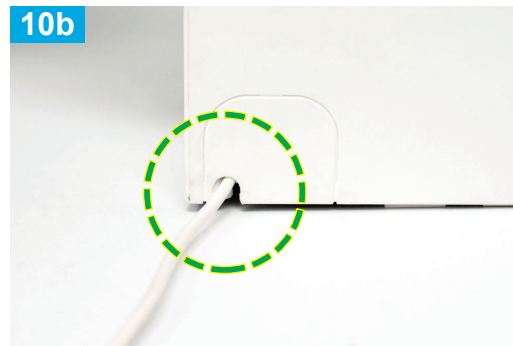

FTX-KN (25/35)

