

XVTS Harmony IO-Link Tower Light

User Manual

EIO0000005746.00

10/2025



Legal Information

The information provided in this document contains general descriptions, technical characteristics and/or recommendations related to products/solutions.

This document is not intended as a substitute for a detailed study or operational and site-specific development or schematic plan. It is not to be used for determining suitability or reliability of the products/solutions for specific user applications. It is the duty of any such user to perform or have any professional expert of its choice (integrator, specifier or the like) perform the appropriate and comprehensive risk analysis, evaluation and testing of the products/solutions with respect to the relevant specific application or use thereof.

The Schneider Electric brand and any trademarks of Schneider Electric SE and its subsidiaries referred to in this document are the property of Schneider Electric SE or its subsidiaries. All other brands may be trademarks of their respective owner.

This document and its content are protected under applicable copyright laws and provided for informative use only. No part of this document may be reproduced or transmitted in any form or by any means (electronic, mechanical, photocopying, recording, or otherwise), for any purpose, without the prior written permission of Schneider Electric.

Schneider Electric does not grant any right or license for commercial use of the document or its content, except for a non-exclusive and personal license to consult it on an "as is" basis.

Schneider Electric reserves the right to make changes or updates with respect to or in the content of this document or the format thereof, at any time without notice.

To the extent permitted by applicable law, no responsibility or liability is assumed by Schneider Electric and its subsidiaries for any errors or omissions in the informational content of this document, as well as any non-intended use or misuse of the content thereof.

Table of Contents

Safety Information.....	4
About The Document	5
Introduction	9
XVTS IO-Link Tower Lights.....	10
Architecture Description	11
IO-Link Device Description	12
Installation.....	13
Wiring.....	14
XVTS Connector Description	14
IO-Link Standard Wiring.....	14
NTSFIO0400 IO-Link Master	15
IO-Link System Configuration	16
Create a New Project.....	16
Associate Hardwares to the Project.....	17
Set IO-Link Master Parameters.....	18
Third-party IO-Link Masters	20
Tower Light Settings	21
Setting Procedure.....	21
Operating Modes.....	22
Tower Light.....	23
Full Spectrum	25
Levelling	27
Programmer	29
IO-Link Parameters	31
Optical	31
Audible	32
Global	34
Reset to Factory Settings	34
Index Parameters	35
How to Control the Tower Light	37
EcoStruxure™ Machine Expert	37
Function Block.....	38
Third-party IO-Link Masters	39
Diagnosis	40
Status LED.....	40
Glossary	41

Safety Information

Important Information

Read these instructions carefully, and look at the equipment to become familiar with the device before trying to install, operate, service, or maintain it. The following special messages may appear throughout this documentation or on the equipment to warn of potential hazards or to call attention to information that clarifies or simplifies a procedure.



The addition of this symbol to a “Danger” or “Warning” safety label indicates that an electrical hazard exists which will result in personal injury if the instructions are not followed.



This is the safety alert symbol. It is used to alert you to potential personal injury hazards. Obey all safety messages that follow this symbol to avoid possible injury or death.

DANGER

DANGER indicates a hazardous situation which, if not avoided, **will result in** death or serious injury.

WARNING

WARNING indicates a hazardous situation which, if not avoided, **could result in** death or serious injury.

CAUTION

CAUTION indicates a hazardous situation which, if not avoided, **could result in** minor or moderate injury.

NOTICE

NOTICE is used to address practices not related to physical injury.

Please Note

Electrical equipment should be installed, operated, serviced, and maintained only by qualified personnel. No responsibility is assumed by Schneider Electric for any consequences arising out of the use of this material.

A qualified person is one who has skills and knowledge related to the construction and operation of electrical equipment and its installation, and has received safety training to recognize and avoid the hazards involved.

About The Document

Document Scope

This documentation is a reference for the IO-Link version of XVTS tower lights.

The purpose of this document is to explain how to configure a XVTS tower light using the IO-Link communication protocol with the EcoStruxure™ Machine Expert or EcoStruxure™ Automation Expert - Motion software.

NOTE: Before installing, operating, or maintaining your IO-Link XVTS tower lights, read this document and all related documents, page 7 to understand all its features.

Validity Note

The characteristics of the products described in this document are intended to match the characteristics that are available on www.se.com. As part of our corporate strategy for constant improvement, we may revise the content over time to enhance clarity and accuracy. If you see a difference between the characteristics in this document and the characteristics on www.se.com, consider www.se.com to contain the latest information.

Product Related Information

 DANGER
HAZARD OF ELECTRIC SHOCK, EXPLOSION OR ARC FLASH
<ul style="list-style-type: none">• Disconnect all power before servicing equipment.• Install properly rated fuses as recommended in this document.• Ensure product is supplied with correct power supply before power on.• To maintain product waterproofness:<ul style="list-style-type: none">◦ No crack/damage is allowed on product after dropped.◦ Screws must be tightened to the require torque level.◦ Ensure gasket is correctly positioned.◦ “Pole” must be fully inserted into the base/fixing plate.◦ XVZ100T and XVZ250T should always be positioned in upright orientation.• Apply lowest IP rating to completed products setup/assembly.• Connect protective earth (PE) to electrical equipment before turning on power.• Electrical equipment should be installed, operated, serviced, and maintained only by qualified personnel.• Do not disassemble or modify this product. Disassembly or modification of this product may result in malfunction or failure.• No responsibility is assumed by Schneider Electric for any consequences arising out of the use of this material.
Failure to follow these instructions will result in death or serious injury.

⚠ WARNING

UNINTENDED EQUIPMENT OPERATION

- Wear protective gloves when commissioning/servicing the products.
- High intensity LED light. Do not expose eyes to light source for long duration.
- Prolonged exposure to loud noise can cause hearing impairment or hearing loss. Wear suitable hearing protection such as earplugs or earmuffs.
- The limited voltage/current source must comply with following:
 - A suitable isolating source in conjunction with a fuse in accordance with UL248, (JDYX2/8).
 - The fuse shall be rated max. T2.5 A and be installed in the 24 Vdc power supply to the device in order to limit the available current.

Failure to follow these instructions can result in death, serious injury, or equipment damage.

General Cybersecurity Information

In recent years, the growing number of networked machines and production plants has seen a corresponding increase in the potential for cyber threats, such as unauthorized access, data breaches, and operational disruptions. You must, therefore, consider all possible cybersecurity measures to help protect assets and systems against such threats.

To help keep your Schneider Electric products secure and protected, it is in your best interest to implement the cybersecurity best practices as described in the [Cybersecurity Best Practices](#) document.

Schneider Electric provides additional information and assistance:

- [Subscribe to the Schneider Electric security newsletter.](#)
- [Visit the Cybersecurity Support Portal web page to:](#)
 - [Find Security Notifications.](#)
 - [Report vulnerabilities and incidents.](#)
- [Visit the Schneider Electric Cybersecurity and Data Protection Posture web page to:](#)
 - [Access the cybersecurity posture.](#)
 - [Learn more about cybersecurity in the cybersecurity academy.](#)
 - [Explore the cybersecurity services from Schneider Electric.](#)

Schneider Electric Products System Cybersecurity

If the XVTS IO-Link tower lights are used in a Schneider Electric products system, [page 11](#), we recommend that you apply the principles detailed in [Cybersecurity Guidelines](#) in order to improve the overall IT security of the system in which the XVTS devices operate.

Environmental Data

For product compliance and environmental information, refer to the Schneider Electric Environmental Data Program.

Available Languages of this Document

This document is available in these languages:

- English (EIO0000005746)
- German (EIO0000005752)
- French (EIO0000005751)
- Spanish (EIO0000005753)
- Italian (EIO0000005754)
- Chinese (EIO0000005755)
- Japan (EIO0000005759)

Related Documents

Title of Documentation	Reference Number
XVTS Tower Light, Instruction Sheet	JPS5080201
EcoStruxure™ Machine Expert - Basic, Operating Guide	EIO0000003281
EcoStruxure™ Machine Expert - Basic, Generic Functions Library Guide	EIO0000003289
EcoStruxure™ Automation Expert - Motion, EcoStruxure™ Machine Expert, Programming Guide	EIO0000002854
EcoStruxure™ Automation Expert - Motion, EcoStruxure™ Machine Expert - Functions and Libraries, User Guide	EIO0000002829
Modicon M262 Logic/Motion Controller, Programming Guide	EIO0000003651
Modicon M262 Logic/Motion Controller, Hardware Guide	EIO0000003659
Modicon Edge I/O NTS Field Device Master Modules, User Guide	EIO0000005270
Modicon Edge I/O NTS Network Interface Modules, User Guide	EIO0000004794
Modicon Edge I/O, System Planning and Installation Guide	EIO0000004786
Modicon Edge I/O Configurator and Web Interface, User Guide	EIO0000004810

You can download these technical publications and other technical information from our website at www.se.com/ww/en/download/.

Information on Non-Inclusive or Insensitive Terminology

As a responsible, inclusive company, Schneider Electric is constantly updating its communications and products that contain non-inclusive or insensitive terminology. However, despite these efforts, our content may still contain terms that are deemed inappropriate by some customers.

Contact us

Select your country on www.se.com/contact.

Schneider Electric Industries SAS

Head Office

35, rue Joseph Monier

92500 Rueil-Malmaison

France

Introduction

Harmony Pro XVTS IO-Link tower lights are industrial devices which provide visual and audible signals. They can be used to monitor the operating status of a machine, a workstation, a moving machine, a production island, and so on.









They use the IO-Link communication protocol, which allows you to configure the devices connected to your IO-Link network, and monitor them remotely using data exchanged over the network.

This chapter describes the characteristics of these XVTS tower lights and their integration into the Schneider Electric products environment.

XVTS IO-Link Tower Lights

Range Overview

The reference list of XVTS IO-Link tower lights is:

XVTS1AG	XVTS1AW	XVTS1ASG	XVTS1ASW
			
No Siren		With Siren	
Ø 70 mm, 9 segments, IO-Link			
XVTS2AG	XVTS2AW	XVTS2ASG	XVTS2ASW
			
No Siren		With Siren	
Ø 70 mm, 15 segments, IO-Link			

Communication Parameters

The communication parameters of the tower lights are:

Parameter	Value
IO-Link revision	Version 1.1
Bit rate	COM3 230,4 kBit/s
Minimum cycle time	6 ms
SIO mode	No
Block parametrization	Yes
Data storage	Yes

Architecture Description

IO-Link Standard Architecture

The architecture of IO-Link systems is built according to the following principle:

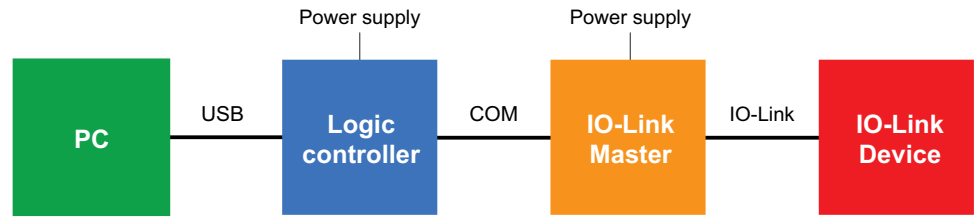

IO-Link devices can only be operated and configured using an IO-Link Master.

Smart Tower Light Architecture

The Smart Tower Light Architecture is a Schneider Electric products system which allows you to use your XVTS IO-Link tower lights:

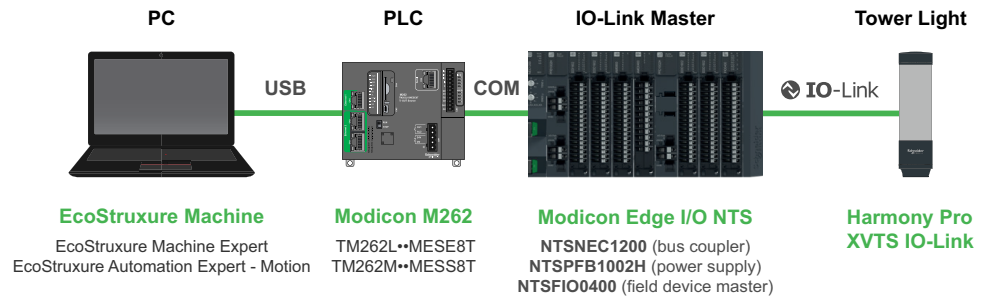

This IO-Link tower light environment is composed of:

PC commissioning tool

- A computer with EcoStruxure™ Machine Expert or EcoStruxure™ Automation Expert - Motion softwares installed (**Modicon Edge I/O NTS – Web Interface** can be used as an alternative),
- Or any third-party IO-Link software (open source or proprietary).

PLC in operation

- Modicon M262 logic/motion controller (TM262M••MESS8T or TM262L••MESE8T),
- Or any third-party PLC.

IO-Link Master

- Modicon Edge I/O NTS (as IO-Link Master), with the following modules:
 - NTSNEC1200 (bus coupler),
 - NTSPFB1002H (power supply),
 - NTSFIO0400 (field device master).
- Or any third-party IO-Link Master.

Harmony Pro XVTS tower lights

IO-Link Device Description

To configure a XVT5 IO-Link tower light, you need to download the IODD file.

This is a standardized file containing device identification (for example: manufacturer, type, and serial number), configurable parameters, process data (measurements and control signals), diagnostic data, and communication characteristics (data rate and format). It is specific to each device and enables automated device recognition, configuration, and troubleshooting.

This file is available at the following addresses:

- Schneider Electric website,
- IODDfinder Portal.

After importing this file into your IO-Link Master, your tower light is automatically recognized.

The procedure to import IODD files depends on the IO-Link Master:

- For the NTSFIO0400 field device master, refer to *Associate Hardwares to the Project*, page 17,
- For third-party IO-Link Masters, refer to the third-party IO-Link document.

Installation

This chapter lists the different mounting accessories that can be used with XVTS IO-Link tower lights.

Overview of mounting accessories and their compatibility:

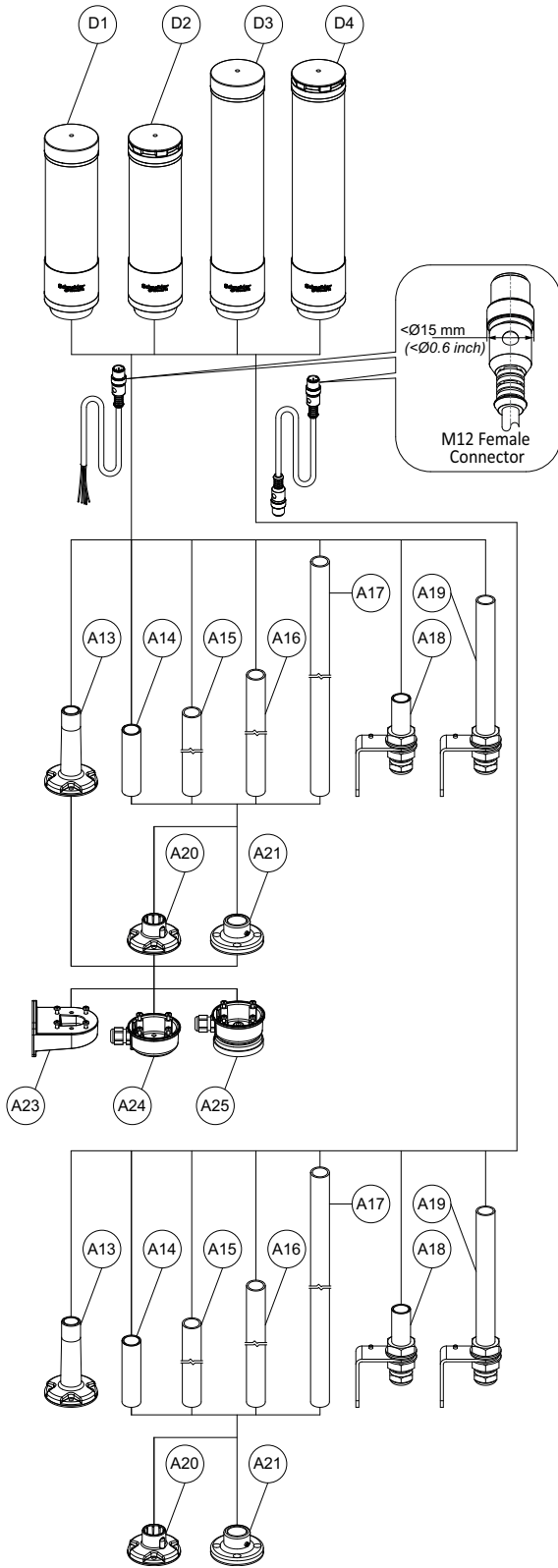

D1	XVTS1AG XVTS1AW	XVTS 9 segments IO-Link no siren grey/white
D2	XVTS1ASG XVTS1ASW	XVTS 9 segments IO-Link siren grey/white
D3	XVTS2AG XVTS2AW	XVTS 15 segments IO-Link no siren grey/white
D4	XVTS2ASG XVTS2ASW	XVTS 15 segments IO-Link siren grey/white
A13	XVZ02	Plastic fixing plate with pole
A14	XVZ100	Aluminium $\varnothing 25 \text{ mm}$ pole 100 mm length
A15	XVZ250	Aluminium $\varnothing 25 \text{ mm}$ pole 250 mm length
A16	XVZ400	Aluminium $\varnothing 25 \text{ mm}$ pole 400 mm length
A17	XVZ800	Aluminium $\varnothing 25 \text{ mm}$ pole 800 mm length
A18	XVZ100T	L bracket aluminium $\varnothing 25 \text{ mm}$ pole 100 mm
A19	XVZ250T	L bracket aluminium $\varnothing 25 \text{ mm}$ pole 250 mm
A20	XVZ01•	Plastic fixing plate
A21	XVZ11	Metal fixing plate
A23	XVZ09	Plastic wall mount bracket
A24	XVZ07	Side entry adapter
A25	XVZ08	Magnetic adapter

For detailed explanations on how to mount and install your tower lights according to your requirements, please refer to the instruction sheet.

Wiring

XVTS Connector Description

The connection is made via a four conductor connector with the following pin assignment:

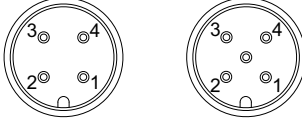
Pin	Conductor colour	IO-Link function	Connectors
1	Brown	L+	
2	White	+24 V (optional)	
3	Blue	L-	
4	Black	C/Q	
5	Grey	Not connected	

IO-Link Standard Wiring

The default factory setting sets the power reduction to **1** (ON). This power reduction is an IO-Link parameter used to limit the current consumption from the IO-Link Master during the initial set up. With this parameter, the current consumption is limited to a maximum of 200 mA. The wiring is as follows:

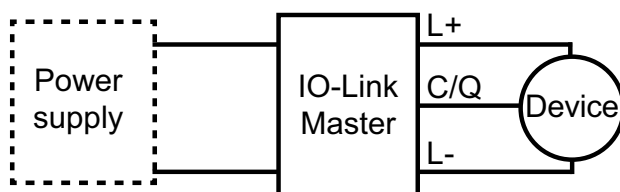

If this power reduction is set to **0** (OFF), current consumption exceeds 200 mA. Some IO-Link Masters require an external auxiliary voltage supply on Pin 2 (+24 V). The proposed wiring are:

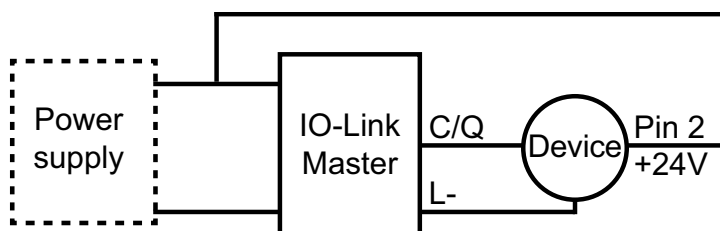

OR

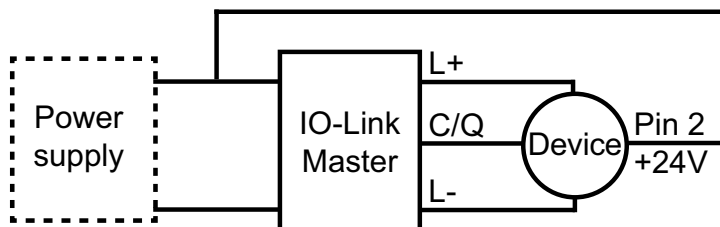

NTSFIO0400 IO-Link Master

With NTSFIO0400 IO-Link Master, XVTS tower lights have to be connected to channels 0 and 1 only.

You have to use wiring compatible with the current restriction of the devices:

NTSFIO0400		XVTS tower lights		Wiring
Max. current limitation of the L+ supply		Current consumption		
Channels	Current	Pwr reduction ON	Pwr reduction OFF	
0 and 1	250 mA	200 mA	> 200 mA	Possible
2 and 3	200 mA	200 mA	> 200 mA	Avoid

The following figure illustrates the wiring of the IO-Link device (class A):

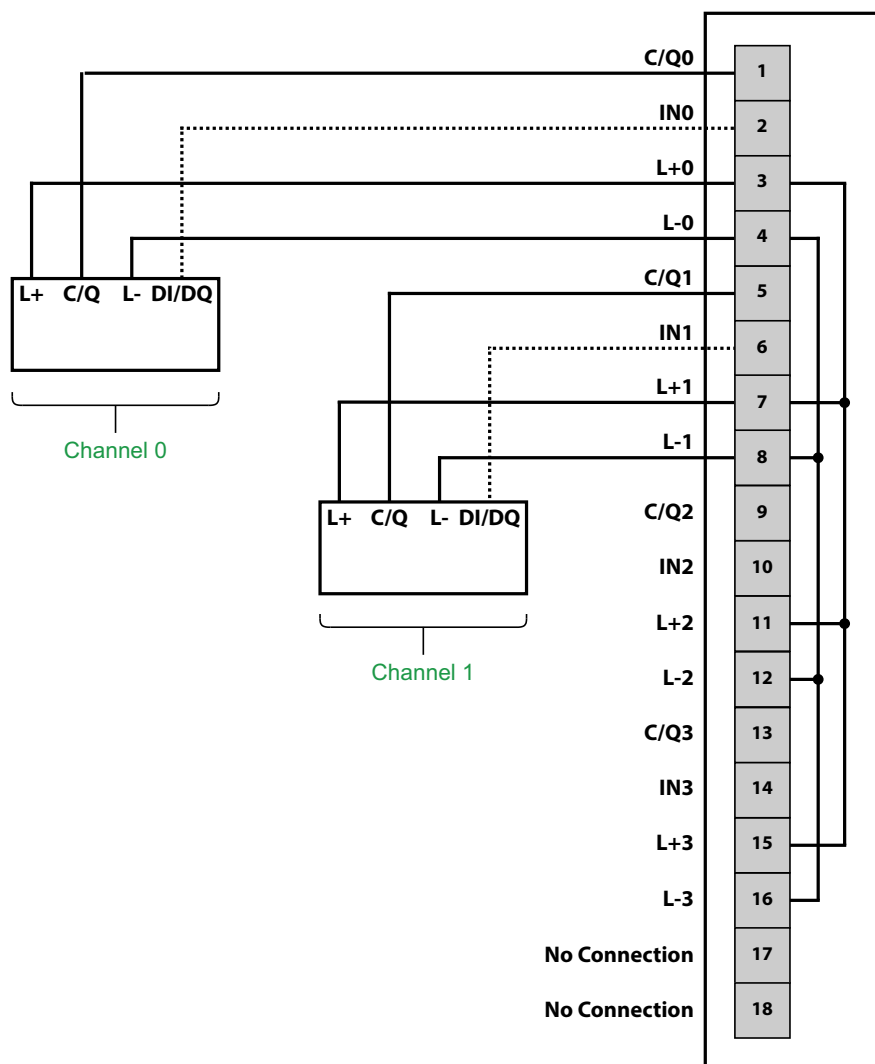

⚠ WARNING

UNINTENDED EQUIPMENT OPERATION

Do not connect wires to unused terminals and/or terminals indicated as “No Connection (N/C)”.

Failure to follow these instructions can result in death, serious injury, or equipment damage.

IO-Link System Configuration

This chapter presents how to integrate XVTS IO-Link tower lights into the Smart Tower Light Architecture, page 11.

Create a New Project

You have to create a new project using a M262 motion controller in EcoStruxure™ Machine Expert:

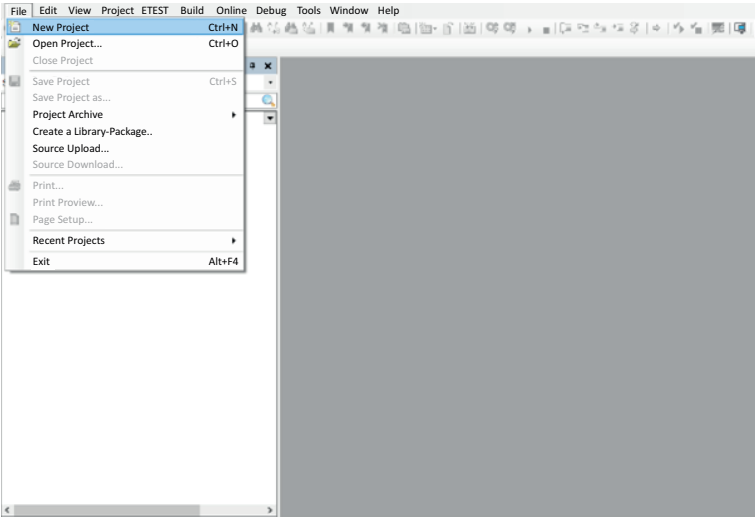
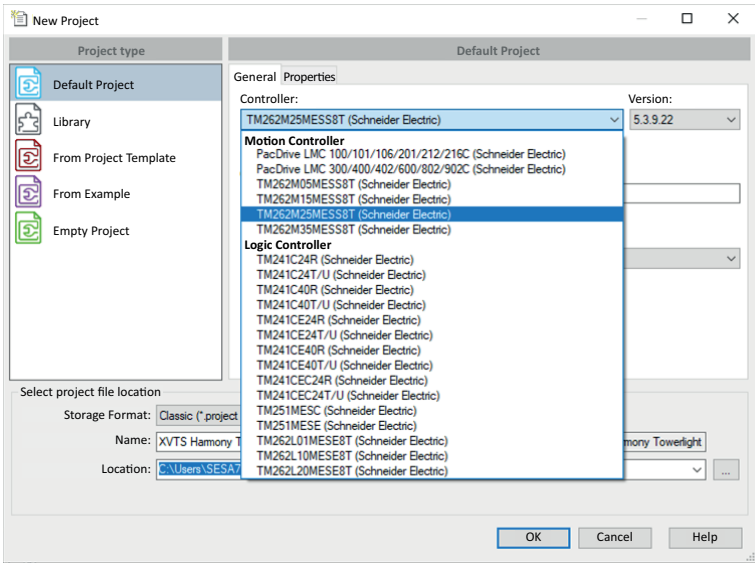
Step	Action
1	<p>At the top left-hand corner, click File > New Project...:</p> 
2	<p>Click the drop-down arrow in the New Project window to select the type of TM262 controller:</p> 
3	<p>At the bottom page, name the project file and select a location path to save the new project.</p>
4	<p>Click the OK button</p>

Associate Hardwares to the Project

Then, you need to add to the newly created project the required hardwares, page 11 for the operation of XVTS IO-Link tower lights:

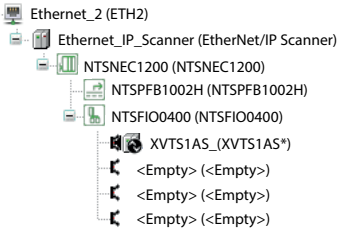
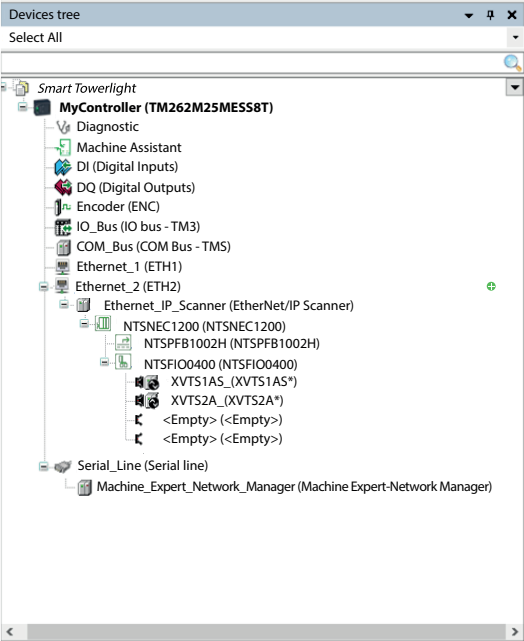
Step	Action
1	<p style="text-align: center;">Add NTSNEC1200 bus coupler</p> <p>In the Device tree window located on the left-hand side, hover over Ethernet_2 (ETH2), click + and double click EtherNet/IP Scanner (or ModbusTCP IO Scanner) under Protocol Managers:</p>  <p>Hover over EtherNet/IP Scanner (or ModbusTCP IO Scanner) to click + EtherNet/IP targets (or ModbusTCP targets) > Bus Coupler and then, double click NTSNEC1200.</p>
2	<p style="text-align: center;">Add NTSFIO0400 field device master</p> <p>Hover over NTSNEC1200 to click + Edge I/O NTS Fieldbus Master and then, double click NTSFIO0400 > Close.</p>
3	<p style="text-align: center;">Add IO-Link devices</p> <p>Under the NTSFIO0400 field device master, hover over the <Empty> (<Empty>) and click + to add the device IODD files, page 12:</p>  <p>NOTE: Channels 0 and 1 support a maximum of two IO-Link devices, so only two tower lights can be added under the NTSFIO0400 field device master. List of available device references:</p> <ul style="list-style-type: none"> • XVTS1A* • XVTS1AS* • XVTS2A* • XVTS2AS* <p>Click the Close button.</p>

Set IO-Link Master Parameters

NTSFIO0400 Field Device Master

Channels Overview

The **Edge I/O NTS Bus I/O Mapping** tab consists of the following channels: 00, 01, 02, and 03. Only channels 0 and 1 can be used.

Each channel consists of parameters of the IODD file that allows you to configure the I/O mapping of the controller.

Establish IO-Link Communication

The **Edge I/O NTS Editor** tab provides system and IO-Link access rights to parameters.

In the **Edge I/O NTS Bus I/O Mapping** tab of the NTSFIO0400 field device master, the **OutputEnabled** parameter for the relevant channel have to be set to 1 before you can write to the light tower:

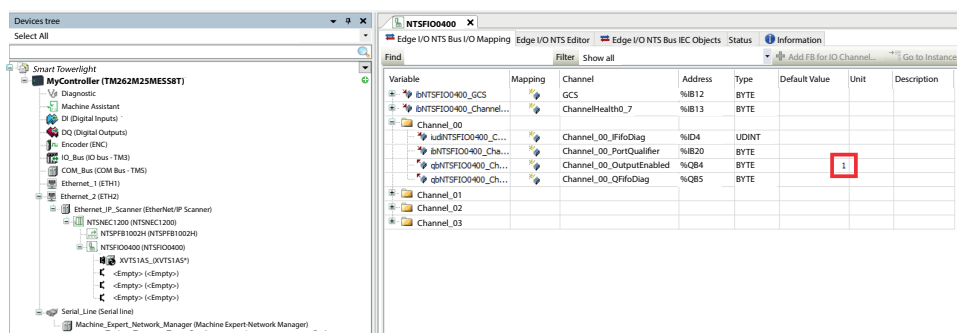

In the **Edge I/O NTS Editor** tab of the NTSFIO0400 field device master, select **Compatible with IO-Link V1.1, without datastorage** to establish a communication with the IO-Link devices:

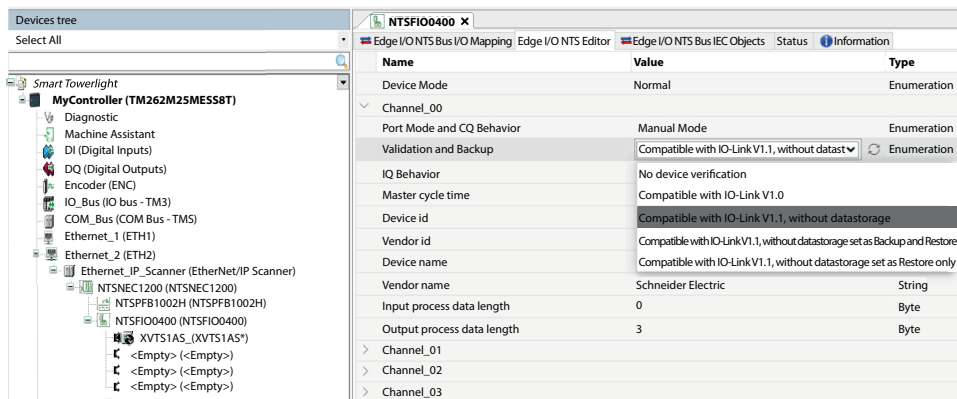

Validation and Backup parameter defines the behavior of the IO-Link Master:

- **No device verification:** IO-Link Master sends the data from the connected IO-Link devices to the controller without performing any checks.
- **Compatible with IO-Link V1.0:** IO-Link Master can communicate with IO-Link devices supporting only version 1.0 of the IO-Link communication protocol.
- **Compatible with IO-Link V1.1, without datastorage:** IO-Link Master does not save its parameters and those of the devices associated with it.
- **Compatible with IO-Link V1.1, datastorage set as Backup and Restore:** IO-Link Master automatically saves its parameters and those of the devices associated with it each time a modification is done.
- **Compatible with IO-Link V1.1, datastorage set as Restore only:** IO-Link Master does not automatically save its parameters and those of the devices associated with it each time a modification is done (backups are performed manually).

The datastorage function is used to duplicate the configuration of an old IO-Link Master to a new one, keeping its configuration and those of the IO-Link devices associated with it.

Modicon Edge I/O NTS – Web Interface

The NTSFIO0400 field device master can also be configured using the **Modicon Edge I/O NTS – Web Interface**:

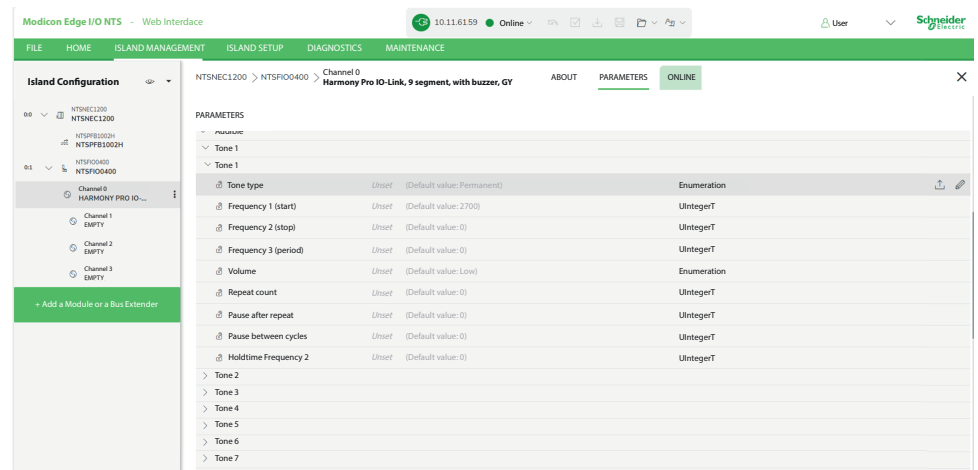

Refer to the Modicon Edge I/O Configurator and Web Interface User Guide to know how to use it.

Third-party IO-Link Masters

For third-party IO-Link Masters, the general procedure to follow is:

Step	Action
1	Connect the tower lights to the dedicated ports on the IO-Link Master using the appropriate connectors, page 14.
2	With a software that manages IO-Link parameterization, set the IO-Link communication protocol of the IO-Link Master to version 1.1.
3	Load the IODD files, page 12 corresponding to your tower lights into your IO-Link Master. IODD files give the IO-Link Master the ability to automatically recognizes connected devices and loads their specific parameters.
4	Configure the tower lights using the IO-Link parameterization software. For more details about the configuration required to get the tower lights up and running, refer to the standard procedure to configure a XVTS IO-Link tower light, page 21.

Refer to the documentation supplied by the manufacturer of your IO-Link Master to know how to perform these actions.

Tower Light Settings

This chapter explains how to configure the tower lights.

With **EcoStruxure™ Machine Expert** and NTSFIO0400 field device master, operating modes be accessed and modified under the **Edge I/O NTS Editor** tab of each tower light. With third-party IO-Link Masters, refer to the documentation supplied by the manufacturer of your IO-Link Master to know how to proceed.

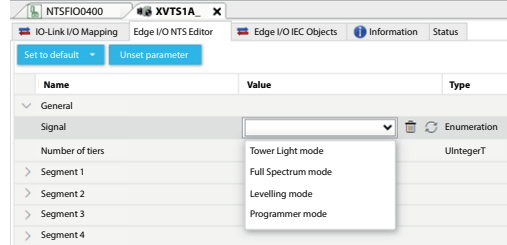

Setting Procedure

Regardless of the IO-Link Master or software used, the standard procedure to configure a XVTS IO-Link tower light is:

Step	Action
1	<p>Select the operating mode by setting the Signal variable with one of these values:</p> <ul style="list-style-type: none"> • Tower Light mode: 0, • Full Spectrum mode: 1, • Levelling mode: 2, • Programmer mode: 3. <p>To understand operating modes, segments, and tiers, refer to <i>Operating Modes</i>, page 22.</p>
2	<p>If you have selected Tower Light or Full Spectrum mode, enter one of the values below for the Number of tiers variable to define the number of tiers to use:</p> <ul style="list-style-type: none"> • XVTS1A*: 1...3, • XVTS2A*: 1...5. <p>NOTE: The IODD accepts values between 0 and 255. However, no values other than those listed above are valid.</p>
3	<p>Configure the segments or tiers (depending on the selected operating mode) by setting the Segment N variables .</p> <p>N is a number between 1 and 15. It depends on the number of segments of your tower light, the operating mode you have selected and the way you configure it:</p> <ul style="list-style-type: none"> • For Tower Light or Full Spectrum mode, set variables according to the number of tiers defined. Examples: <ul style="list-style-type: none"> ◦ If you have define two tiers, set Segment 1 and Segment 2 variables, ◦ If you have define four tiers, set Segment 1 to Segment 4 variables. • For Levelling or Programmer mode, set variables according to the number of segments of the XVTS device: <ul style="list-style-type: none"> ◦ For XVTS1A*: set Segment 1 to Segment 9 variables, ◦ For XVTS2A*: set Segment 1 to Segment 15 variables. <p>NOTE: To configure segments individually in Levelling mode, set the Filling Level mode variable to 0 before.</p> <p>To configure a segment or a tier, refer to <i>Optical</i>, page 31.</p>
4	<p>For XVTS*AS* only, configure the sirens by setting the Tone N (N = 1...10) variables.</p> <p>To configure a siren, refer to <i>Audible</i>, page 32.</p>
5	<p>Configure additional parameters.</p> <p>Refer to <i>Global</i>, page 34 or the IODD.</p>

Operating Modes



XVTS tower lights can be operated in four different modes. These operating modes define the behavior of the segments that compose the tower lights.

The segments are the unitary physical elements of the devices, their role is to display coloured light signals (with optional light effects).

When the segments are grouped together, they are referred to as a “tier” and use the same parameters (colour, brightness, light effect).

The operating mode you choose has an impact on the way you can configure your tower light. You have to understand the differences between each mode to choose the one that meets your requirements.

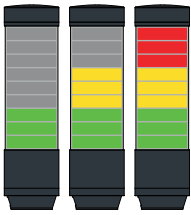
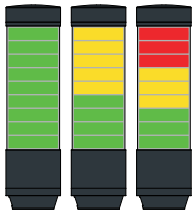
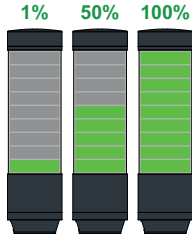
Overview of the operating modes:

XVTS Operating Modes	Tower Light	Full Spectrum	Levelling	Programmer
Display example				
Optical configuration by	Tiers	Tiers	Segments	Segments
Main purpose	Classic signaling	Maximum visibility	Progress indication	Highly configurable
Details	Tower Light, page 23	Full Spectrum, page 25	Levelling, page 27	Programmer, page 29

Tower Light

Overview

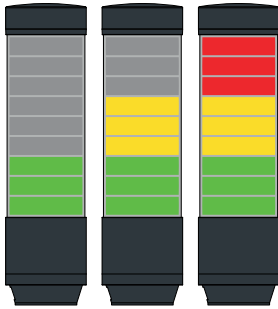

Individual segments are combined into tiers.

Each tier has a fixed position and is ON if its optical signal is triggered. For this reason, it is possible to have non-illuminated tiers.

- **XVTS1A**: three tiers maximum,
- **XVTS2A**: five tiers maximum.

Each tier has its own configuration.

The process data bits control the relevant tower light tiers.

Process Data Table

The following table indicates which process data bits control which tiers depending on the number of tiers defined:

Process data		Number of tiers defined				
		1 Tier	2 Tiers	3 Tiers	4 Tiers	5 Tiers
Byte 0	Bit 0	Tier 1 1) Segment 1 to 9 2) Segment 1 to 15	Tier 1 1) Segment 1 to 4 2) Segment 1 to 7	Tier 1 1) Segment 1 to 3 2) Segment 1 to 5	Tier 1 1) N/A 2) Segment 1 to 3	Tier 1 1) N/A 2) Segment 1 to 3
	Bit 1		Tier 2 1) Segment 5 to 9 2) Segment 8 to 15	Tier 2 1) Segment 4 to 6 2) Segment 6 to 10	Tier 2 1) N/A 2) Segment 4 to 7	Tier 2 1) N/A 2) Segment 4 to 6
	Bit 2			Tier 3 1) Segment 7 to 9 2) Segment 11 to 15	Tier 3 1) N/A 2) Segment 8 to 11	Tier 3 1) N/A 2) Segment 7 to 9
	Bit 3				Tier 4 1) N/A 2) Segment 12 to 15	Tier 4 1) N/A 2) Segment 10 to 12
	Bit 4					Tier 5 1) N/A 2) Segment 13 to 15
	Bit 5					
1) For XVTS1A• 2) For XVTS2A• "N/A" means "Not applicable"						

Example Settings for XVT51A•

Example of a tower light configured with three tiers:

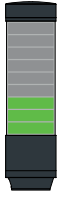
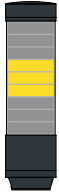
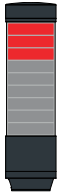
Process data value example			Active tier number	Segments	Default colour	Illustration
Decimal	Binary	Bit				
1	0001	0	1	1...3	Green	
2	0010	1	2	4...6	Yellow	
4	0100	2	3	7...9	Red	

Full Spectrum

Overview

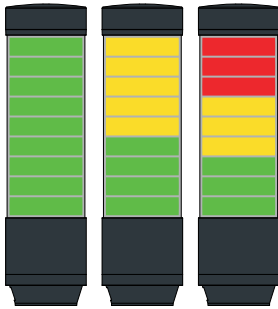

All segments are illuminated and automatically divided equally depending on the total number of segments available on the device:

- If only one tier is active, all segments are illuminated in a single colour,
- If several tiers are active, the segments are illuminated in equal parts in different colours.

If the tiers cannot be divided into an equal number of segments, the remaining segments are allocated to the first configured tiers.

- **XVTS1A**: three tiers maximum,
- **XVTS2A**: five tiers maximum.

Each tier has its own optical parameters configuration. The tower light activates the segments depending on the activated tiers.

Process Data Table

The following table indicates which process data bits control which tiers depending on the number of tiers defined:



Number of tiers defined						
Process data		1 Tier	2 Tiers	3 Tiers	4 Tiers ¹	5 Tiers ¹
Byte 0	Bit 0	Tier 1	Tier 1	Tier 1	Tier 1	Tier 1
	Bit 1		Tier 2	Tier 2	Tier 2	Tier 2
	Bit 2			Tier 3	Tier 3	Tier 3
	Bit 3				Tier 4	Tier 4
	Bit 4					Tier 5
	Bit 5					
¹ Not applicable for XVTS1A						

Segments are illuminated according to the number of tiers configured and activated.

The device illuminates all segments, applying the configurations of the activated tiers equally.

Example Settings for XVTS1A•

Example of a tower light configured with three tiers:

Process data value example			Active tier number	Segments	Default colour	Illustration
Decimal	Binary	Bit				
1	0001	0	1	1...9	Green	
3	0011	0	1	1...4	Green	
		1	2	5...9	Yellow	
7	0111	0	1	1...3	Green	
		1	2	4...6	Yellow	
		2	3	7...9	Red	

Levelling

Overview

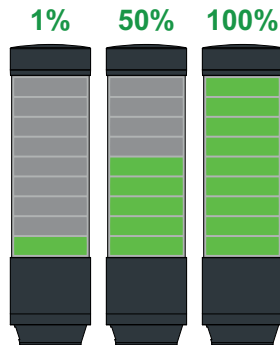

Segments are used as a filling level indicator.

This mode enables signalization of job progress or material availability in machine processes by slowly illuminating the tower light from bottom to top or top to bottom.

All segments are used. Each of them can have specific parameters.

The optical parameters of the segments are managed as follows:

- By default, the **Filling Level mode** variable is set to **1** (**Segment 1** variable parameters are used for all segments).
- Set the **Filling Level mode** variable to **0** in order for each segment uses the parameters of its variable.



Process Data Table

The table below shows the relationship between percentages and illuminated segments:

Levelling % (allowed value: 0...100)		
Segment number	XVTS1A•	XVTS2A•
1	1...19	1...11
1...2	20...29	12...17
1...3	30...39	18...23
1...4	40...49	24...29
1...5	50...59	30...35
1...6	60...69	36...41
1...7	70...79	42...47
1...8	80...89	48...53
1...9	90...100	54...59
1...10	Not applicable	60...65
1...11		66...71
1...12		72...77
1...13		78...83
1...14		84...89
1...15		90...100

Example Settings for XVTS1A•

Examples of a tower light with default and custom settings:

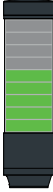
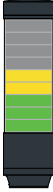
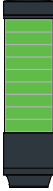
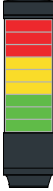
Process data value example		Segments	Filling Level mode = 1 (Use tier 1 settings)		Filling Level mode = 0 (Use individual settings)	
Decimal	Binary		Default colour	Illustration	Custom colour	Illustration
1	0000001	1	Green		Green	
50	0110010	1...5	Green		Yellow	
100	1100100	1...9	Green		Red	

Programmer

Overview



Segments have no predefined behavior. The tower light configuration is to be entirely programmed.

These extended configuration capabilities make it possible to meet more specific requirements that other modes cannot.

One bit controls one segment. Each segment can be individually configured, and each of them can be used or not depending on the defined configuration.

While the XVTS device is in operation, it is still possible to modify the configuration of the tower light. However, some softwares like EcoStruxure™ Machine Expert do not provide this feature, but control of the tower light is still possible using process data.

Tower Light, Full Spectrum and Levelling operating modes can be manually replicated in Programmer mode.

Process Data Table

The parameters from segments 1 to 9 (XVTS1A•) or 1 to 15 (XVTS2A•) are used for configuration.

Byte	1								0							
Bit	7	6	5	4	3	2	1	0	7	6	5	4	3	2	1	0
Segment	—	15	14	13	12	11	10	9	8	7	6	5	4	3	2	1





The process data output range are:

- XVTS1A•: **0-511** (decimal)
- XVTS2A•: **0-32767** (decimal)

Process data		Programmer mode
Byte 0	Bit 0	Segment 1
	Bit 1	Segment 2
	Bit 2	Segment 3
	Bit 3	Segment 4
	Bit 4	Segment 5
	Bit 5	Segment 6
	Bit 6	Segment 7
	Bit 7	Segment 8
Byte 1	Bit 0	Segment 9
	Bit 1	Segment 10
	Bit 2	Segment 11
	Bit 3	Segment 12
	Bit 4	Segment 13
	Bit 5	Segment 14
	Bit 6	Segment 15
	Bit 7	—

Example Settings for XVT51A•

The examples below are a few examples of possible configurations:

Process data value example			Segments	Default colour	Illustration
Decimal	Binary	Bit			
1	00000001	0 (<i>Byte 0</i>)	1	Green	
17	000010001	0 (<i>Byte 0</i>)	1	Green	
		4 (<i>Byte 0</i>)	5	Turquoise	
80	001010000	4 (<i>Byte 0</i>)	5	Turquoise	
		6 (<i>Byte 0</i>)	7	Light yellow	
511	111111111	0 (<i>Byte 0</i>)	1	Green	
		1 (<i>Byte 0</i>)	2	Blue	
		2 (<i>Byte 0</i>)	3	Red	
		3 (<i>Byte 0</i>)	4	Violet	
		4 (<i>Byte 0</i>)	5	Turquoise	
		5 (<i>Byte 0</i>)	6	White	
		6 (<i>Byte 0</i>)	7	Light yellow	
		7 (<i>Byte 0</i>)	8	Yellow	
	1 (<i>Byte 1</i>)	9	Green		

IO-Link Parameters

Optical

Overview

Whatever the operating mode, the following segment parameters can be modified: colour, light effect, and brightness.

Segment Parameters

There are as many **Segment** variables as there are segments in your tower light.

Each of them can be configured according to the following parameters:

Parameter	Value	Description
Lighteffect segment N	0	Continuous
	1	Blinking 3 Hz
	2	Blinking 2 Hz
	3	Blinking 1 Hz
	4	Flashing (1x)
	5	Flashing (2x)
	6	Flashing (3x)
	7	Rotating
Quotient R	0...255	Quotient R
Quotient G	0...255	Quotient G
Quotient B	0...255	Quotient B
Brightness segment N	0	Minimum
	1	Low
	2	High
	3	Maximum
Default colour	0	Individual PWM
	1	Red
	2	Green
	3	Blue
	4	Yellow
	5	Light Yellow
	6	Turquoise
	7	Violet
	8	White
Quotient RGB is only applicable when Individual PWM is selected under the Default Colour . This feature allows you to switch to a specific preferred colour by entering values not included in the list.		

Audible

Overview

Ten preset tones are available to define the siren behavior.

The process data output range is between **1 to 10**. Each of these values refers to a tone presented in [Predefined Tones](#), page 32.

Process data table:

Byte	0							
Bit	—	—	—	—	3	2	1	0

Predefined Tones

Tone	Type	Frequency (start, stop, period)	Max.dB
1	Permanent	2700, 0, 0	104
2	Permanent	900, 0, 0	96
3	Pulse	2100, 0, 4200	97
4	Pulse	900, 0, 200	93
5	Pulse	2646, 0, 200	103
6	Pulse	900, 0, 10	96
7	Pulse	2700, 0, 10	104
8	Sweep	2300, 3600, 5	104
9	Permanent	2646, 0, 0	105
10	Alternating	1200, 800, 10	95

Custom Tones

To configure a tone, select a tone type and use the following parameters:

Parameter	Value	Description
Tone type	0	Sound off
	1	Permanent
	2	Pulse
	3	Rising
	4	Falling
	5	Alternating
	6	Sweep
Frequency 1 (start)	245...6000	Frequency at the start of a cycle in Hz
Frequency 2 (stop)	0 (Tone type 1) 245...6000 (Tone type 2...6)	Frequency at the end of a cycle in Hz
Frequency 3 (period)	0 (Tone type 1) 1...10000 (Tone type 2...6)	Frequency for time between frequency 1 and frequency 2 in Hz*10
Volume	0	Low
	1	Medium
	2	Loud
	3	Very loud
Repeat count	0...65535	Repeat count
Pause after repeat	0...65535	Pause after repeat
Pause between cycles	0...65535	Duration of the pause between cycle in ms
Hold time frequency 2	0...65535	Setting of the hold time for frequency 2 in ms

The following diagram shows the respective effects of the parameters:

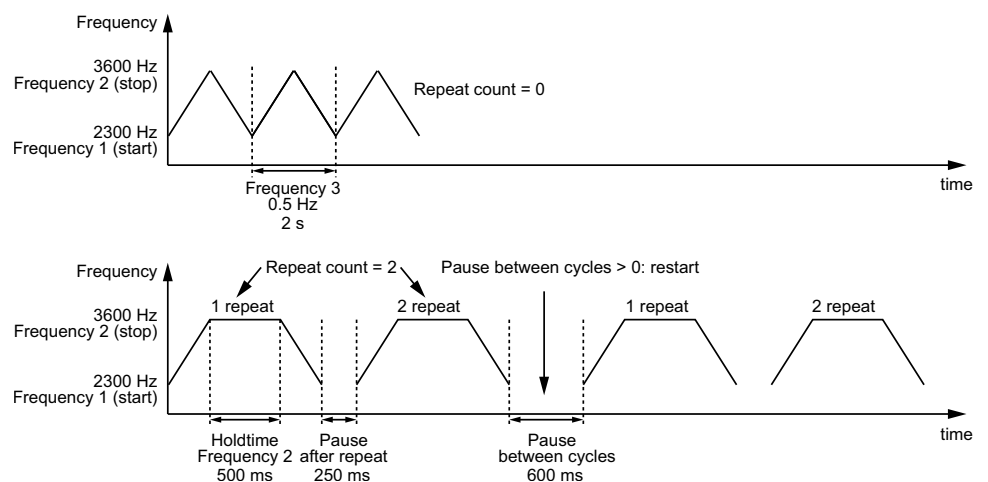

Global

Parameter	Value	Description
Power reduction	0	Power reduction is disabled. Current consumption can exceed 200 mA.
	1	Power reduction is activated. Current consumption is under 200 mA.
Installation position	0	Normal (base at bottom of tower)
	1	Upside down
User text	Text with maximum 232 characters	Free text

Reset to Factory Settings

The **Reset Factory Settings** feature erases your current configuration and restore the default factory settings.

It can be enabled by entering the value **130** in **System Command** standard variable.

The default operating mode is Full Spectrum mode, page 25 and tiers are configured as follows:

- **XVTS1A**• (three tiers): Green/Yellow/Red
- **XVTS2A**• (five tiers): White/Blue/Green/Yellow/Red

Power reduction (current consumption) is activated, page 34.

After the power reduction has been cancelled, the LEDs are set to continuous light.

Index Parameters

Index	Sub-index	Parameter	Access	Byte length	Value
2	—	System command	wo	1	<ul style="list-style-type: none"> • 129 = Application Reset, • 130 = Restore Factory Settings, • 131 = Back-to-box.
16	—	Vendor Name	ro	48	Schneider Electric
17	—	Vendor Text	ro	48	Schneider Electric
18	—	Product Name	ro	32	Complete product name.
19	—	Product ID	ro	16	XVTS•A••
20	—	Product Text	ro	64	Additional product information for the device.
21	—	Serial Number	ro	16	Default value: 0000000000000000
22	—	Hardware Revision	ro	16	Default value: 1.0
23	—	Firmware Revision	ro	16	Default value: 1.2.3
24	—	Application-specific Tag	rw	32	Possibility to mark a device with user or application-specific information.
25	—	Function Tag	rw	32	Default value: ***
26	—	Location Tag	rw	32	Default value: ***
36	—	Device Status	ro	8	<ul style="list-style-type: none"> • 0 = Device is OK, • 1 = Maintenance required, • 2 = Out of specification, • 3 = Functional check, • 4 = Detected failure.
37	—	Detailed Device Status	ro	48	List of all currently pending events in the device.
74	—	Operating hours	ro	4	Default value: 0
100	—	Signal	rw	1	<ul style="list-style-type: none"> • 0 = Tower light mode, • 1 = Full spectrum mode, • 2 = Levelling mode, • 3 = Programmer mode.
101–115	1	Lichteffect	rw	1	<ul style="list-style-type: none"> • 0 = Continuous, • 1 = Blinking 3Hz, • 2 = Blinking 2Hz, • 3 = Blinking 1Hz, • 4 = Flashing 1x, • 5 = Flashing 2x, • 6 = Flashing 3x, • 7 = Rotating.
—	2	Quotient R	rw	1	The default value depends on the segment.
—	3	Quotient G	rw	1	The default value depends on the segment.
—	4	Quotient B	rw	1	The default value depends on the segment.
—	5	Brightness	rw	1	<ul style="list-style-type: none"> • 0 = Minimum, • 1 = Low, • 2 = High, • 3 = Maximum.

Index	Sub-index	Parameter	Access	Byte length	Value
—	6	Default Colour	rw	1	<ul style="list-style-type: none"> • 0 = Individual PWM, • 1 = Red, • 2 = Green, • 3 = Blue, • 4 = Yellow, • 5 = Light Yellow, • 6 = Turquoise, • 7 = Violet, • 8 = White.
—	7	Not used	rw	1	—
—	8	Priority	rw	1	—
120–130	1	Tone type	rw	1	<ul style="list-style-type: none"> • 0 = Sound off, • 1 = Permanent, • 2 = Pulse, • 3 = Rising, • 4 = Falling, • 5 = Alternating, • 6 = Sweep.
—	2	Frequency 1 (start)	rw	2	Default value: 2700
—	3	Frequency 2 (stop)	rw	2	Default value: 0
—	4	Frequency 3 (period)	rw	2	Default value: 0
—	5	Volume	rw	1	<ul style="list-style-type: none"> • 0 = Low, • 1 = Medium, • 2 = Loud, • 3 = Very loud.
—	6	Repeat count	rw	2	Default value: 0
—	7	Pause after repeat	rw	2	Default value: 0
—	8	Pause between cycles	rw	2	Default value: 0
—	9	Holdtime Frequency 2	rw	2	Default value: 0
131	—	Power reduction (current consumption)	rw	1	<ul style="list-style-type: none"> • 0 = Off, • 1 = On (200mA max.)
132	—	Filling Level mode	rw	1	<ul style="list-style-type: none"> • 0 = Use individual settings, • 1 = Use tier 1 settings.
138	—	Installation position	rw	1	<ul style="list-style-type: none"> • 0 = normal, • 1 = upside down.
139	—	Number of tiers	rw	1	Default value: 5
Abbreviation meanings of "Access" column: <ul style="list-style-type: none"> • ro: Read only • wo: Write only • rw: Read and write 					

How to Control the Tower Light

Overview

To control your XVTS tower light, you have to send to the IO-Link Master a process data.

For more details, refer to:

- Optical, page 31
- Audible, page 32

The way to send the process data depends on the IO-Link Master used.

EcoStruxure™ Machine Expert

With EcoStruxure™ Machine Expert, you have to write your process data into the corresponding addresses of the I/O mapping.

You can also directly enter yours process data values in the **Prepared Value** column:

Variable	Mapping	Channel	Address	Type	Default Value	Current Value	Prepared Value
		Audible (signal mode)	%QB10	USINT		0	
		Bit0	%QX10.0	BOOL		FALSE	
		Bit1	%QX10.1	BOOL		FALSE	
		Bit2	%QX10.2	BOOL		FALSE	
		Bit3	%QX10.3	BOOL		FALSE	
		Bit4	%QX10.4	BOOL		FALSE	
		Bit5	%QX10.5	BOOL		FALSE	
		Bit6	%QX10.6	BOOL		FALSE	
		Bit7	%QX10.7	BOOL		FALSE	
		Optical (signal mode)	%QW6	UINT		0	
		Bit0	%QX12.0	BOOL		FALSE	
		Bit1	%QX12.1	BOOL		FALSE	
		Bit2	%QX12.2	BOOL		FALSE	
		Bit3	%QX12.3	BOOL		FALSE	
		Bit4	%QX12.4	BOOL		FALSE	
		Bit5	%QX12.5	BOOL		FALSE	
		Bit6	%QX12.6	BOOL		FALSE	
		Bit7	%QX12.7	BOOL		FALSE	
		Bit8	%QX13.0	BOOL		FALSE	
		Bit9	%QX13.1	BOOL		FALSE	
		Bit10	%QX13.2	BOOL		FALSE	
		Bit11	%QX13.3	BOOL		FALSE	
		Bit12	%QX13.4	BOOL		FALSE	
		Bit13	%QX13.5	BOOL		FALSE	
		Bit14	%QX13.6	BOOL		FALSE	
		Bit15	%QX13.7	BOOL		FALSE	

Function Block

Functional Description

Function block is used to validate audible and optical values sent to the tower light.

You have to add the function block to the Program Organizational Unit and link it to your tower light in the device tree. POU manages the internal mapping of audible and optical addresses, there is no need to configure these in the I/O mapping.

The **mode** (*XVTS_Mode*) of the tower light has to be configured by you.

Library Name and Namespace

Library name: **XVTS_InputValidation**

Namespace: **XVTS_IV**

Graphical Representation

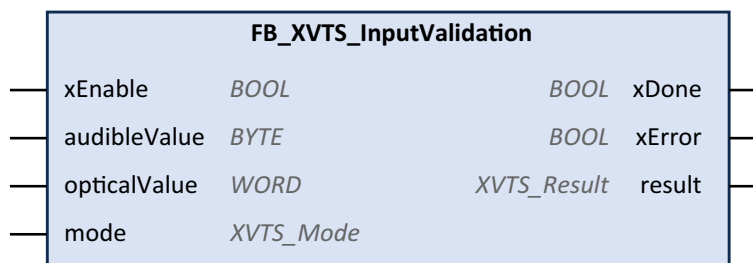

Inputs

Input	Data type	Description
xEnable	BOOL	Values range: FALSE or TRUE Default value: FALSE Description: Trigger input validation
audibleValue	BYTE	Values range: • Byte: 0...255 • Word: 0...65535 Default value: 0 Description: Value for siren, page 32
opticalValue	WORD	Values range: • Byte: 0...255 • Word: 0...65535 Default value: 0 Description: Value for signal, page 31
mode	XVTS_Mode	Values range: • Towerlight (INT): 0 • FullSpectrum (INT): 1 • Levelling (INT): 2 • Programmer (INT): 3 Default value: 1 Description: Operating mode, page 22 of the connected tower light

Outputs

Input	Data type	Description
xDone	BOOL	Values range: FALSE or TRUE Default value: FALSE Description: Validation progress
xError	BOOL	Values range: FALSE or TRUE Default value: FALSE Description: Validation state
result	XVTS_Result	Values range: <ul style="list-style-type: none"> • Values_OK (INT): 0 Both values are OK • Values_NOK (INT): 1 Both values are OUT OF RANGE • MinMaxDefine_Unknown (INT): 2 Minimum and maximum value is Unknown • AudibleValue_NOK (INT): 3 Input audible value is OUT OF RANGE • OpticalValue_NOK (INT): 4 Input optical value is OUT OF RANGE Description: Validation result

Third-party IO-Link Masters

Refer to the documentation of the manufacturer of your IO-Link Master to know how to send process data values to it.

Diagnosis

Status LED

The functional status of the tower lights is displayed via one LED. The status LED is located in the base of the tower lights, behind the type label:

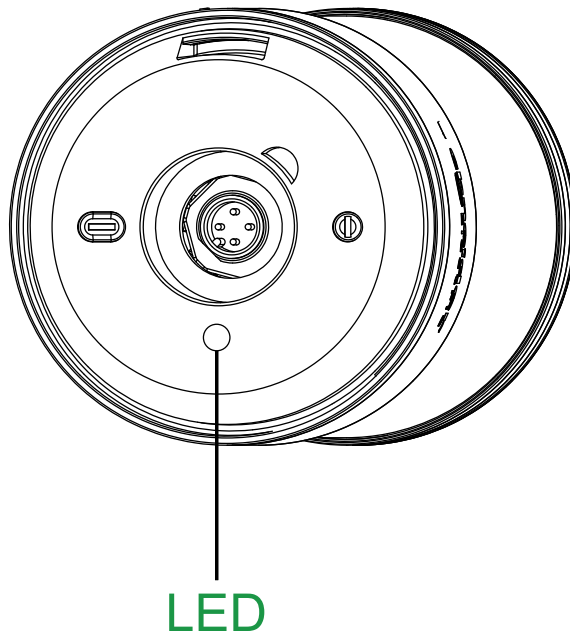

The LED colours convey the following information:

- **Red flashes** (500 ms ON, then 500 ms OFF): power supply is OFF (no IO-Link communication),
- **Red flashes** (900 ms ON, then 100 ms OFF): connection interrupted,
- **Green flashes** (900 ms ON, then 100 ms OFF): power supply is ON (IO-Link communication is working),
- **Light yellow** (permanent): firmware update is running.

If no LED is active, check the power supply and the connection cable.

Glossary

B

Bus coupler: Device which is used to couple one bus to the other without any interruption in power supply and without creating hazardous arcs.

E

EcoStruxure™ Automation Expert: Automation software for engineering control systems.

EcoStruxure™ Machine Expert: Software for developing, configuring and commissioning a complete machine.

I

IO-Link Master: Device which acts as a gateway between the field IO-Link devices and the control system. These devices communicate their status and diagnostics back to the Master, which then relays this information to the central control system.

IO-Link: Point-to-point interface, manufacturer-independent, for connecting sensors and actuators. It is a fieldbus-independent communication protocol (IEC 61131-9 compliant) that can be integrated into any current bus system.

IODD: Set of files in a Zip file format including the main IODD file, optional language files, optional picture files and the manufacturer declaration.

P

PLC: (*Programmable Logic Controller*) Industrial computer that has been ruggedized and adapted for the control of manufacturing processes.

POU: (*Program Organizational Unit*) Term used for all programming objects (such as programs or function blocks) which are used to create a controller application.

S

Segment: Physical unitary element of the tower light.

T

Tier: A set of segments having same parameters.

Tower Light: Column-shaped device fitted with electric lights used to provide visual signals (and audible signals if equipped with a siren).

Schneider Electric
35 rue Joseph Monier
92500 Rueil Malmaison
France

www.se.com

As standards, specifications, and design change from time to time, please ask for confirmation of the information given in this publication.

© 2025 Schneider Electric. All rights reserved.

EIO0000005746.00