



## **OPERATION AND INSTALLATION MANUAL**

### *RM12F1 Remote Controller*

Thank you for purchasing the remote controller.  
This manual describes the safety precaution requirement of using this product.





Thank you for purchasing this remote controller. Carefully read this OPERATION AND INSTALLATION MANUAL before using the controller. It will tell you how to use the controller properly and help you if any trouble occurs. After reading the manual, please keep it for future reference.



# Contents

---

Installation .....	1
1. Installation Precautions .....	1
2. Installation Accessories .....	3
3. Dimensions of Remote Controller and Bracket .....	3
4. Installation and Fixing .....	4
5. Replace the Batteries .....	5
Operating the Remote Controller .....	7
1. Using Precautions .....	7
2. Model and Key Parameters .....	8
3. Button Names and Functions .....	9
4. Name and Function on Display Screen .....	11
5. Operating Methods .....	12
5.1 On/Off Operations .....	12
5.2 Mode and Temperature Operations .....	12
5.3 Fan Speed Operations .....	13
5.4 Soft Wind Operations .....	14
5.5 Vane Selection Operations .....	14
5.6 Swing Operation .....	14
5.7 IDU Display Operations .....	15
5.8 Silent Mode Operation .....	16
5.9 Midea ETA function Operations .....	16
5.10 Sterilize function Operations .....	17
5.11 Timer On/Off Operations .....	17
5.12 Self cleaning Operation .....	19
5.13 Button Lock Operations .....	19
5.14 Auxiliary Heater Operations (reserved) .....	19
Field Settings .....	20
1. Initial Parameter Configuration .....	20
2. Advanced Parameter Configuration .....	22
3. Indoor Units parameter check function .....	26
4. Indoor Unit Address Query and Setting .....	26
5. Indoor Unit Capacity Code Query .....	26

# Installation

---

## 1. Installation Precautions

### Safety Considerations

Please read this "Safety Considerations" carefully before installing Controller and be sure to install it correctly. After completing the installation, make sure the controller operates properly.

Please instruct the customer how to operate the controller and how to perform maintenance.

### Meaning of Caution Symbols



Failure to observe these instructions properly may result in property damage or personal injury.

---

Information classified as **NOTE** contains instructions to ensure proper use of the controller.

---



- Ensure that nothing interrupts operation of the wireless remote controller.
  - Ensure that the signal from the remote controller can easily be transmitted.
  - Ensure that the operation display lamp and other indicator lamps can easily be seen.
  - Ensure that there is neither a source of light nor a fluorescent lamp near the receiver.
  - Ensure that the receiver is not exposed to direct sunlight.
-

# Installation

---



## WARNING

### Precautions in handling remote controller

- Direct the transmitting part of the remote controller to the receiving part of the air conditioner.
- If something blocks the transmitting and receiving path of the indoor unit and the remote controller as curtains, it will not operate.

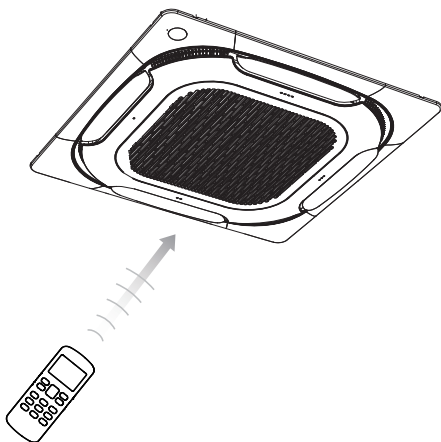

- Transmitting distance is approximately 7 m.
- 1 short beeps from the receiver indicates that the transmission is properly done.
- Do not drop or get it wet. It may get damaged.
- Never press the button of the remote controller with a hard, pointed object. The remote controller may get damaged.





### Installation site

- It is possible that signals will not be received in rooms that have electronic fluorescent lighting. Please consult with the salesman before buying new fluorescent lights.
- If the remote controller operated some other electrical apparatus, move that machine away or consult your dealer.

# Installation

## 2. Installation Accessories

• Please check that you have all the following parts.

No.	Name	Schematic	Qty
①	Remote controller bracket		1
②	Screw lid		1
③	Philips head screw (M2.9*12)		2
④	AAA battery		2
⑤	Remote controller manual		1

## 3. Dimensions of Remote Controller and Bracket

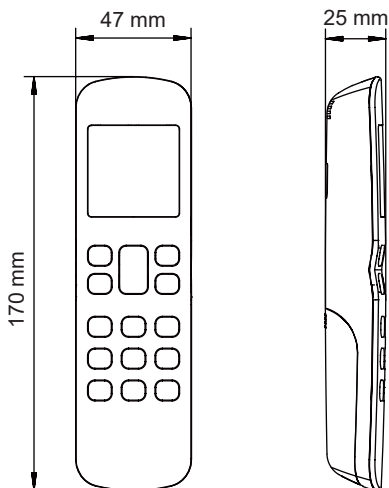

Figure 2.1 Dimensions of remote controller

# Installation

---

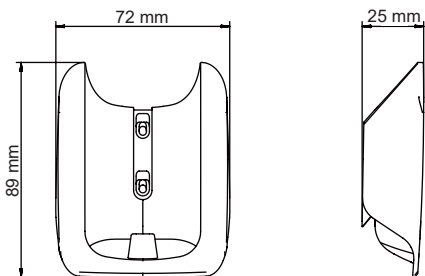

Figure 2.2 Dimensions of remote controller bracket

## 4. Installation and Fixing

1) Use the screws (accessories) to fix and secure the remote controller bracket in a stable position (see Figure 2.3);

Make sure you refer to "1. Installation Precautions" to determine the location.

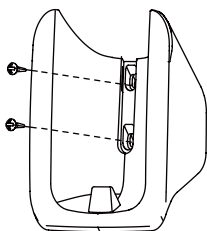

Figure 2.3

2) Slot the screw lid into the bracket cover on top of the screws (see Figure 2.4);

# Installation

---

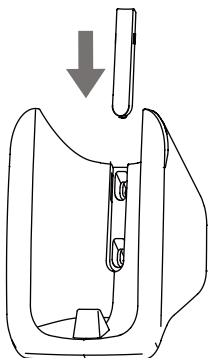

Figure 2.4

3) Slide the remote controller vertically down into the remote controller bracket (see Figure 2.5).

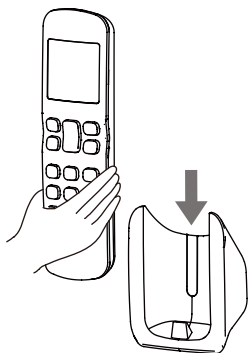

Figure 2.5

## 5. Replace the Batteries

1) Slide to move the battery cover at the back of the remote controller in the direction indicated by the arrow (Figure 2.6);

# Installation

---

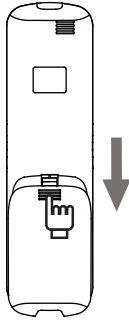

Figure 2.6

2) Lift up from the lower left end of the battery cover to open it (see Figure 2.7);

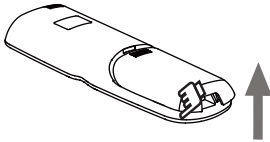

Figure 2.7

3) Take out the old batteries. Install two new AAA batteries according to the positive and negative polarities indicated (see Figure 2.8). Close the battery cover.

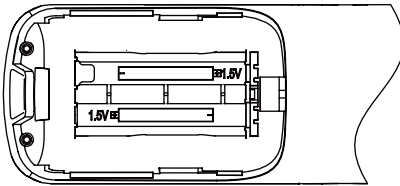

Figure 2.8

# Operating the Remote Controller

---

## 1. Using Precautions

To gain full advantage of the controller's functions and to avoid malfunction due to mishandling, we recommend that you read this instruction manual carefully before use.

The precautions described herein are classified as **WARNING** and **CAUTION**. They both contain important information regarding safety. Be sure to observe all precautions without fail.

---



### **WARNING**

Failure to follow these instructions properly may result in personal injury or loss of life.



### **CAUTION**

Failure to observe these instructions properly may result in property damage or personal injury, which may be serious depending on the circumstances.

---

Information classified as **NOTE** contains instructions to ensure proper use of the controller.

After reading, keep this manual in a convenient place so that you can refer to it whenever necessary. If the controller is transferred to a new user, be sure also to hand over the manual.

---



### **WARNING**

Note that prolonged, direct exposure to cool or warm air from the air conditioner or to air that is too cold or warm can be harmful to your physical body and health.

- Do not use pesticides, disinfectants and flammable sprays to spray directly on the remote controller as these may cause the device to become deformed.
  - If there is a fault with the remote controller, turn off the remote controller and contact your local agent.
  - Remove the dry batteries before cleaning or maintenance of the remote controller. Do not wash the controller with water.
-

# Operating the Remote Controller

---



## CAUTION

- Do not operate the device with wet hands to prevent water from entering the remote controller and damage the circuit board.
  - Do not use the air conditioner for purposes other than those for which it is intended. Do not use the air conditioner to cool precision instruments, food, plants, animals or works of art as this may adversely affect the performance, quality, and/or lifespan of the object concerned.
  - Ventilate the area from time to time. Be careful when you use the air conditioner with other heating equipment. Insufficient ventilation may result in oxygen deficiency.
- 

## 2. Model and Key Parameters

<b>Product Model</b>	RM12F1
<b>Rated Voltage</b>	3.0 V (AAA battery x 2)
<b>Ambient Temperature</b>	-5 to 43°C
<b>Ambient Humidity</b>	RH ≤ 90%

# Operating the Remote Controller

## 3. Button Names and Functions

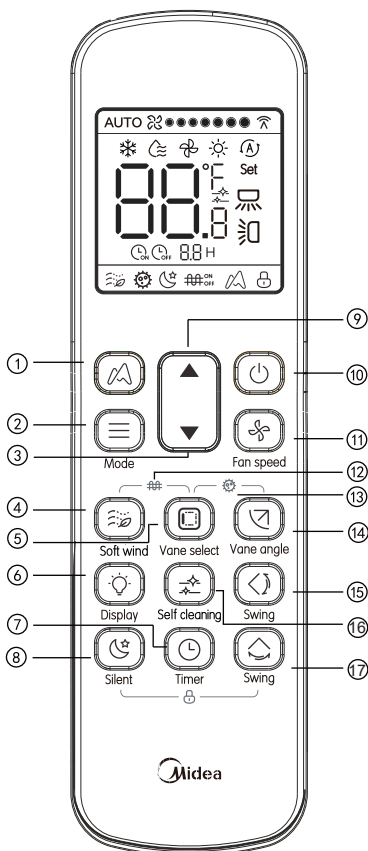





















Figure 3.1 External view of remote controller

# Operating the Remote Controller

No.	Button	Function
①	 Midea ETA function	Turn on/off the Midea ETA function
②	 Mode	Set operating mode: Cool → Dry → Fan → Heat
③	▼ Adjust downwards	Adjust the temperature setting or timer (programmed time) downwards
④	 Soft wind	In Cool mode, press this button to turn on or off the Soft wind function.
⑤	 Vane select	In power-on status, press this button to select a vane to be controlled.
⑥	 Display	Turn on or off the display of the indoor unit
⑦	 Timer on/off	Set the time to turn on/off the unit
⑧	 Silent	Turn on/off the silent function
⑨	▲ Adjust upwards	Adjust the temperature setting or timer (programmed time) upwards
⑩	 On/off switch	Switch on/off the unit
⑪	 Fan speed	Fan speed setting
⑫	 Auxiliary heater	Turn on/off the auxiliary heater function
⑬	 Sterilize	Turn on/off the sterilize function
⑭	 Vane angle	Adjust the angle of the horizontal louver
⑮	 Swing	Turn on/off the vertical swing function
⑯	 Self cleaning	Turn on/off the Self cleaning function
⑰	 Swing	Turn on/off the horizontal swing function

# Operating the Remote Controller

## Note:

- The buttons  and  are not available for first generation indoor units.
- The button  is only available for indoor unit with individual vane control function.
- The  is only available for indoor unit with soft wind function.

## 4. Name and Function on Display Screen

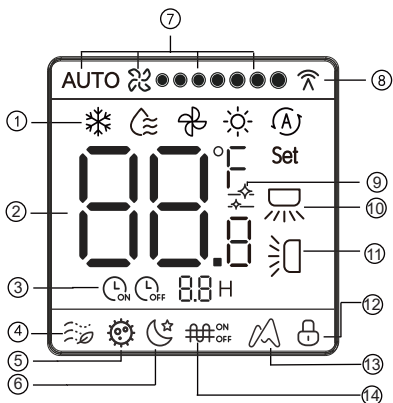

Figure 3.2 Display screen of remote controller

No.	Name	Display Function
①	Operating mode	Displays the current operating mode
②	Temperature	Displays current temperature setting
③	Timer On/Off	Displays times to turn on/off the unit
④	Soft wind	In Cool mode, press this button to turn on or off the Soft wind function
⑤	Sterilize function	Shows that Sterilize function is on
⑥	Silent mode	Shows that Silent is on
⑦	Fan speed	Displays the current fan speed
⑧	Signal transmission	Displays signal send to the indoor unit from the remote controller

# Operating the Remote Controller

⑨	Self cleaning	Shows Self cleaning function is on
⑩	Horizontal swing	Shows that Horizontal Swing is on
⑪	Vertical swing	Shows that Vertical Swing is on
⑫	Lock	Shows that the remote controller button is locked
⑬	Midea ETA function	Shows that Midea ETA function is on
⑭	Auxiliary heater	Shows that auxiliary heater is on

## 5. Operating Methods

### 5.1 On/Off Operations

1) Press  (see Figure 3.3), Indoor unit starts to run;

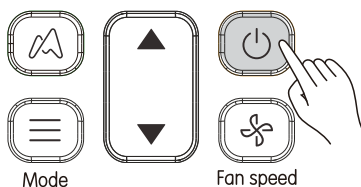



Figure 3.3

2) Press  again. the indoor unit stops running. In power-off status, modes are displayed.

### 5.2 Mode and Temperature Operations

1) Press  (see Figure 3.4). Display screen shows the operating mode ;

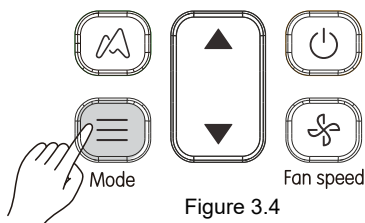

Figure 3.4

# Operating the Remote Controller

2) Press  each time to change the operating mode according to the order shown in Figure 3.5;



Figure 3.5

3) In Cool, Dry or Heat mode, press ▲ and ▼ to adjust the temperature setting. Press ▲ and ▼ to adjust the temperature by 1°C (default). Long press to change the temperature continuously.

Note:

- Temperature setting cannot be adjusted in the Fan mode.

## 5.3 Fan Speed Operations

Every time when you press the  button, fan speed is changed in the following order.(see Figure 3.6).

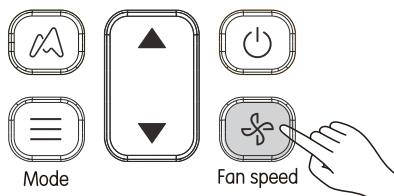

Figure 3.6

1) 7 fan speeds: The default in the remote controller is the mode with 7 fan speeds, where the Fan Speed will be adjusted in turn as shown in Figure 3.7;



Figure 3.7

2) 3 fan speeds: Fan Speed will be adjusted in turn as shown in Figure 3.8.

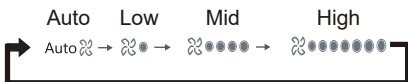

Figure 3.8

Note: • The fan speed set on the remote controller should match with the air conditioner. For how to set the fan speed, see section “Initial Settings” in this document.

- Fan speeds cannot be adjusted in Dry mode.

# Operating the Remote Controller

## 5.4 Soft Wind Operations

Press  to adjust the direction of the vertical louver (see Figure 3.9).



Figure 3.9

- ① In Cool mode, press this button to turn on or off the Soft wind function.
- ② In Soft wind function, the fan operates at the minimum speed and swings at the minimum angle.

## 5.5 Vane Selection Operations

In power-on status, press this button to select the vane to be controlled. If you press this button continuously, you can select vanes in circulating manner.

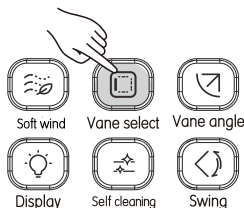



Figure 3.10

The indicator in the indoor unit corresponding to the selected vane will be on, and then off after 15 seconds. After selecting the vane to be controlled, you can use  and  set the swing angle.

## 5.6 Swing Operation

### 1) Vertical Swing



① When the unit is on. Press  (see Figure 3.11). Start the vertical swing function, and the  will light up, and signal is sent to the indoor unit;



Figure 3.11

# Operating the Remote Controller

② When the vertical swing is on, press  to turn off this function.

Note:

- When the unit is turned off, the  button is invalid.
- Each time the vertical swing signal is sent, the icon keeps lighting up for 15s and then disappears. The indoor unit remains vertical swing operation.

## 2) Horizontal Swing

① When the unit is on. Press  (see Figure 3.12). Start the horizontal swing function, and  will light up, and signal is sent to the indoor unit;

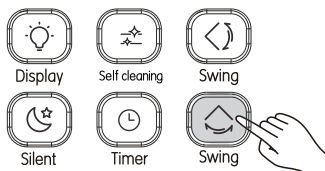



Figure 3.12

② When the horizontal swing is on, press  to turn off the horizontal swing function.

Note:

- When the unit is turned off, the  button is invalid.
- Each time the horizontal swing signal is sent, the icon keeps lighting up for 15s and then disappears. The indoor unit remains horizontal swing operation.

## 5.7 IDU Display Operations

The Display function is used to control the on/off state of the display in the indoor unit.

1) When the remote controller is in on or off state, press  (see Figure 3.13), and the display of the indoor unit lights up;

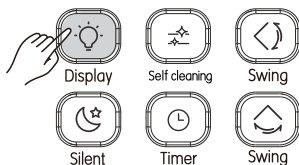





Figure 3.13

# Operating the Remote Controller

2) When the display of the indoor unit lights up, press  to turn off the light.

## 5.8 Silent Mode Operation

The Silent function is used by the remote controller to send the "Silent" signal to the indoor unit. The indoor unit automatically optimizes the noise it generates when it is in the "Silent" mode.

1) When the unit is in the Cool or Heat mode, press  (see Figure 3.14) to start the Silent function. Screen displays the  icon;

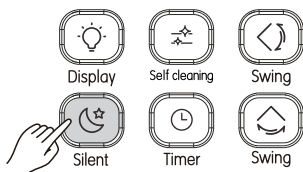





Figure 3.14



2) In Silent mode, press  to turn off the Silent function, and the  icon will disappear.

Note:

- Once it has been running for 8 hours,  will no longer light up, and the unit will exit the Silent mode.
- The Silent and Midea ETA functions cannot be implemented at the same time.

## 5.9 Midea ETA function Operations

The remote controller can send the Midea ETA function signal to the indoor unit when the unit is operating in Cool or Heat mode.

1) Press  (see Figure 3.15) to send the Midea ETA function signal to the indoor unit. The  icon is displayed;

2) Then press , , ,  or  to exit the Midea ETA function. The  icon disappears.

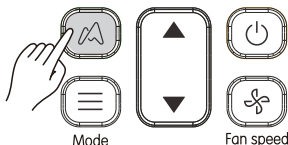



Figure 3.15

# Operating the Remote Controller

Note:

- When Midea ETA function is set up, the Fan Speed is forced to Auto.
- Once it has been running for 8 hours,  will no longer light up.
- The Silent and Midea ETA function cannot be implemented at the same time.

## 5.10 Sterilize function Operations







1) Press  and  at the same time to start the Sterilize function. The screen will display the  icon (see Figure 3.16);



Figure 3.16

2) When the Sterilize function is on, press  and  at the same time to turn off this function, and the  icon will disappear from the display.

## 5.11 Timer On/Off Operations

"Timer" is used to set the timed on/off state of indoor unit.

1) When the unit is powered on:

① Press  (see Figure 3.17), and the remote controller will display "Timer off", and "0.0H" will appear in the timer area. Adjust the Timer Off settings now;

② Press  to adjust the timer settings;

③ Once the adjustment is done, the timer information is sent to the indoor unit.

indoor unit.indoor unit.

# Operating the Remote Controller

2) When the unit is powered off:



- ① Press  (see Figure 3.17), and the remote controller will display "Timer On", and "0.0H" will appear in timer area. Adjust the Timer On settings now;
- ② Press  to adjust the timer settings;
- ③ Once the adjustment is done, the timer information is sent to the indoor unit.





Figure 3.17

Note:

- When Timer On is being set, you can set the power-on mode, fan speed, and temperature.
- If the timing period is more than 10 hours, the timing period increases by 1 hour.
- To change the time: Press the corresponding button, change the time, and then confirm the changes.
- Adjust the Timer on/off to 0.0h to cancel the Timer on/off settings.

## 5.12 Self cleaning Operation

Press  (see Figure 3.18) to send the Self cleaning signal to the indoor unit. The  icon is displayed

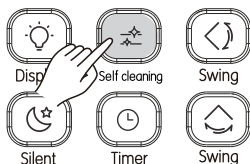







Figure 3.18

# Operating the Remote Controller

## 5.13 Button Lock Operations

Once the buttons on the remote controllers are locked, all the other button operations except for Unlock and IDU Address Setting are invalid.

- 1) Press  and  at the same time to lock the button (see Figure 3.19), and the screen will display the lock icon  ;
- 2) Press  and  at the same time, and the lock icon  will disappear. Button is unlocked.

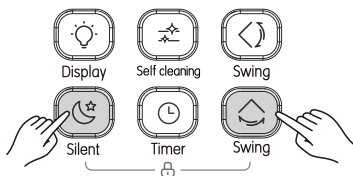







Figure 3.19

## 5.14 Auxiliary Heater Operations (reserved)

- 1) Press  and  at the same time to start auxiliary heater (see Figure 3.20), and the screen will display the icon  ON ;
- 2) Press  and  at the same time, and the screen will display the icon  OFF , the signal of stop the auxiliary heater will send to the IDU.

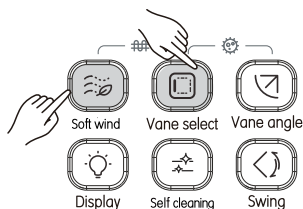

Figure 3.20

# Field Settings

## 1. Initial Parameter Configuration for Remote Controller

1) Configuration Method:





① Long press  and  on the remote controller at the same time for 8 seconds to go to the parameter settings status (see Figure 4.1);



Figure 4.1

② Press  and  to adjust the parameter value;

③ Once the adjustment is done, press  or wait for 5 seconds to save the parameter settings. The operation sequence for the button is as shown in Figure 4.2.

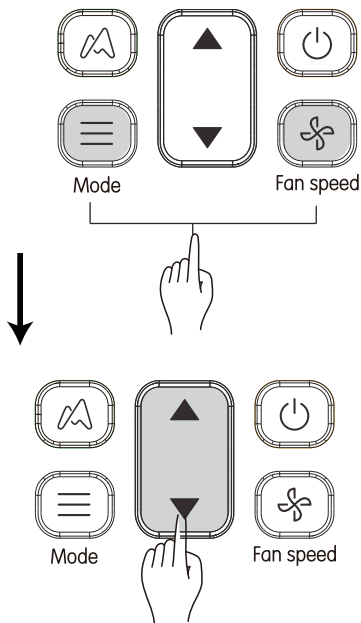

# Field Settings

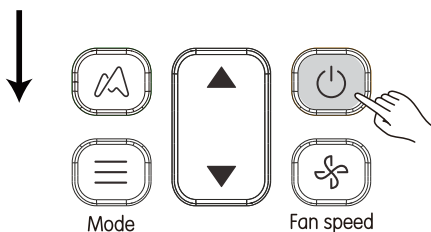

Figure 4.2

2) See Table 4.1 for details.

Table 4.1 Parameters of remote controller

Parameter	Parameter Definition
00	7 fan speeds, temperature adjustment step of 0.5°C(default parameter)
01	3 fan speeds, temperature adjustment step of 1°C
02	7 fan speeds, temperature adjustment step of 1°C
03	3 fan speeds, temperature adjustment step of 0.5°C
04	7 fan speeds, temperature adjustment step of 0.5°C, Auto Mode
05	3 fan speeds, temperature adjustment step of 1°C, Auto Mode
06	7 fan speeds, temperature adjustment step of 1°C, Auto Mode
07	3 fan speeds, temperature adjustment step of 0.5°C, Auto Mode

Note:



- For the first generation indoor units, please set the parameter to 01.

# Field Settings

## 2. Advanced Parameter Configuration for Remote Controller

### 1) Configuration Method:

Parameters can be set in the state of power on or off.

① Long press  and  on the remote controller at the same time for 8 seconds to go to the advanced parameter settings status, "C1" will be displayed in the temperature display area (see Figure 4.3);

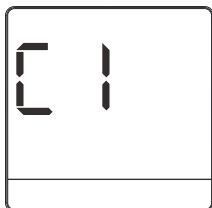



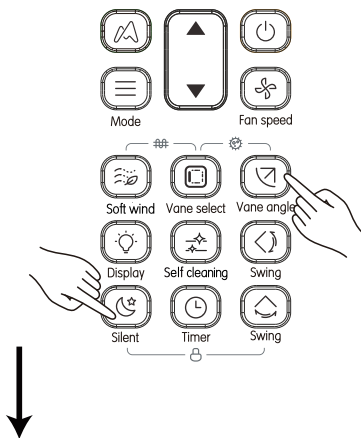

Figure 4.3

② Press  and  to adjust the parameter code;

③ Press  to enter the parameter setting interface, then press the "" and "" keys to adjust the parameter value, refer to the advanced parameter setting list to select the setting parameters. (see Figure 4.4);



# Field Settings

---

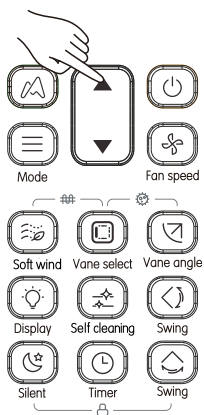





Figure 4.4

- ④ Parameter query: press the  to send the query code, and the indoor unit display board displays the parameter code;
- ⑤ Parameter setting: press the  key to send the setting code;
- ⑥ Press the  to return to the previous layer until you exit the parameter setting;
- ⑦ If you enter the parameter code setting interface for the first time, you will exit the parameter setting automatically without operation after 60 seconds. If there is operation in the parameter setting interface, you will exit the parameter setting after 60 seconds.

2) See Table 4.2 for details.

Table 4.2 Advanced Parameters Setting.

Table 4.2 Advanced Parameters Setting

Parameters Code	Parameters	Parameter Value	Range of Value	The 2nd DC indoor Unit	The 2nd Fresh Air Processing Unit	The 2nd AC indoor Unit	AHU-return air Control	AHU-supply air Control
C1	Indoor unit ESP setting	00-19/FF	00	Refer the static pressure settings in IDU IOM			/	
C2	Indoor unit stop fan motor time reaching heating temperature	00/01/02/03/04/FF	00	4min/8min/12min/16min/0min/4min	/	4min/8min/12min/16min/0min/4min	fixed 10min	/
C3	Indoor unit cold air prevention temperature setting	00/01/02/03/FF	00	15°C/20°C/24°C/26°C/15°C	14°C/12°C/16°C/18°C/14°C	15°C/20°C/24°C/26°C/15°C		14°C/12°C/16°C/18°C/14°C
C4	Indoor unit heating temperature compensation	00/01/02/03/04/FF	00	6°C/2°C/4°C/6°C/0°C/6°C	/	6°C/2°C/4°C/6°C/0°C/6°C		/
C5	Indoor unit cooling temperature compensation	00/01/FF	00	0°C/ 2°C/0°C	/	0°C/ 2°C/0°C		/
C6	Indoor unit Auto restart function	00/01/FF	00	Enable/ Disable				
C7	Opening selection of electronic expansion valve for heating and standby mode	00/01/02/FF	01	56P/72P/0P/72P			72P/72P/72P/72P	
C8	Opening conditions of electric auxiliary heating outdoor temperature	40-90	80	-5 ~ 20°C, 15°C by default in IU software				
C9	mode switching time interval in automatic mode	00/01/02/03	00	15min/30min/60min/90min 15min by default in IU software				

## Field Settings

---



Note:

- ①FF: FF means that this setting has a corresponding dial switch on the IDU PCB and the position of the switch determines the value of this parameter.
- ②Default Value: It means this parameter does not have a dial switch on the main PCB and in case of no setting, the default value shall prevail;
- ③ “The indoor unit fan stop time in heating mode” and the “Opening Degree of EXV” are two mutually exclusive settings. The setting which is done in the last would be effective. When set the heating EXV standby position later , the indoor unit fan switching time will automatically change to default value. When you set the fan stop time later , the default EXV opening will change to 72 p automatically
- ④AHU includes two options: return air and fresh air control. If AHU is written only, it indicates that both of these controls are applicable simultaneously.





# Field Settings

---

## 3. Indoor Units Parameter Check Function



In the state of power on or off, long press the  and  together for 8 seconds to enter the parameter setting page, then press the  to send the command, and the indoor unit display will show the IDU current parameters corresponding to particular IDU model, for more information refer to IDU installation and operation instruction. Generally, The first parameter refers to IDU address, and the second refers to IDU capacity/HP.

## 4. Indoor Unit Address Query and Setting

In the state of power on or off, long press the ,  and  together for 8 seconds to enter the address query page, then press the  to send the address query command .

In Setting page, press UP and DOWN to adjust the address up and down respectively. Press  to send the address to the indoor unit.

## 5. Indoor Unit Capacity Code Query

In the state of power on or off, long press the  and  together for 8 seconds to enter the capacity code query page, Press  to homepage.



## 更改说明页，不做菲林

### 印刷技术要求

材质	80g双胶纸
规格	104*184(双面)
颜色	黑白
其他	/

### 设计更改记录表（仅做说明用，不做菲林）

版本升级	更改人	更改日期	更改主要内容	涉及更改页面 (印刷页码)
A升级到B	邹健伟	20221124	修改描述 修改默认参数 由02改到00 修改描述	P17 P21  P16
C升级到D	邹健伟	20230223	修改描述	P26

