

# INSTALLATION & OWNER'S MANUAL

## TC3-10.1 Touch Screen Centralized Controller

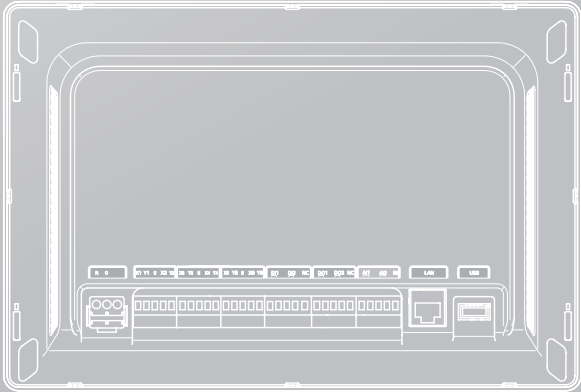

Thank you for purchasing our product.  
Before using the unit, please read this manual carefully and keep it for future

# CONTENTS

---

<b>Safety Precautions</b> .....	02
<b>Hardware Installation</b> .....	04
<b>Product Description</b> .....	06
<b>1 Initial Use</b> .....	06
● 1.1 Connection with VRF System .....	09
● 1.2 Language Selection upon Initial Power-on .....	09
● 1.3 Login .....	10
● 1.4 Search (Topology) .....	11
● 1.5 Modification of Device Name .....	13
● 1.6 Group Function Examples .....	15
● 1.7 Control Device.....	21
● 1.8 Schedule Function Examples .....	23
<b>2 Function Description</b> .....	06
● 2.1 Homepage .....	32
● 2.2 Group and Device Management.....	32
● 2.3 Device Monitoring .....	44
● 2.4 Schedule Management.....	58
● 2.5 Setting.....	68

---

# Safety Precautions

The Installation & Owner's Manual of this product describes how to properly handle the product, prevent personal injury and property losses, as well as how to use the product correctly and safely. Read the following carefully, make sure you understand the content (symbols and marks), and observe the precautions below.

## CAUTION

Read the safety warnings carefully prior to installation.

Be sure to observe the important safety precautions provided below.





Meanings of labels:

 **Warning** Indicates that improper handling may lead to personal injury or material loss.

 **Caution** Indicates that the operations will be affected due to ignoring a precaution.

After the installation is completed, confirm that no errors occur during the trial run, and hand over the manual to the customer for safekeeping.

## Icon description

Icon	Description	
	Prohibited. Information about what is specifically prohibited is provided using graphs or texts in the icon or nearby.	
	Mandatory. A specific mandatory requirement is provided using graphs or texts in the icon or nearby.	
	Commissioned Installation	Ask your local dealer or professionals to install the product. Installation personnel must have relevant professional knowledge. Incorrect installation by non-professionals may lead to a fire, electric shock, or injury.
	Prohibited	Do not directly spray combustible paints on the touch screen centralized controller as this may cause a fire.
	Prohibited	Do not handle the product with wet hands, and do not let water seep into the device. Otherwise, an electric shock may occur.

## WARNING

This unit must be installed by professional technicians. Users are not allowed to install the unit themselves; otherwise, personal injury or damage to the controller may occur.

Other electrical wiring work must be carried out by a professional technician according to the circuit diagram. All wiring work must comply with electrical safety specifications.

It is forbidden to modify the use and function of the product without authorization.

---











## CAUTION

- Do not install the product in places that are prone to flammable gas leaks. Flammable gas that leaks and lingers around the touch screen centralized controller may cause a fire.
- Do not install the touch screen centralized controller in base stations and other places where there is strong electromagnetic interference, where dust and other tiny particles can easily gather, and locations that are wet or easily exposed to water and sunlight; otherwise, the touch screen may perform poorly or stop working.
- Install the touch screen centralized controller indoors, with the distance between the installation place and the ground of more than 50cm and less than 200cm.
- Keep the touch screen centralized controller away from other devices to ensure that there is enough space for installation and heat dissipation. Keep away from heating devices; otherwise, the touch screen centralized controller may not function properly.
- In the event of any malfunction, please contact a professional technician. DO NOT disassemble or repair the unit without authorization.

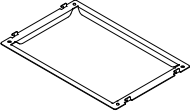
This equipment is not suitable for places where children gather.

# Hardware Installation

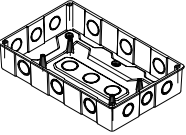
## Packing List

<p>1 × TC3-10.1</p> 	<p>1 × 3-port terminal with gap of 5.08mm</p> 
<p>1 × Manual</p> 	<p>6 × 5-port terminal with gap of 3.81mm</p> 
<p>1 × Mounting board</p> 	<p>6 × Plastic expansion nails</p> 
<p>8 × Plastic washers (Ø 4mm hole)</p> 	<p>6 × GB/T950 M4*20 screws (short)</p> 
<p>1 × Embedded junction box</p> 	<p>4 × GB/T823 M5*25 screws (long)</p> 

### Statement :

Along with upgrades in the product, the information in this document is subject to change without notice.

### Important information

Product serial No.: you can find the serial number on the back of the product.

# Touch screen TC3-10.1 structure

## 1) Touch screen TC3-10.1: Front and side views

(Unit: mm)

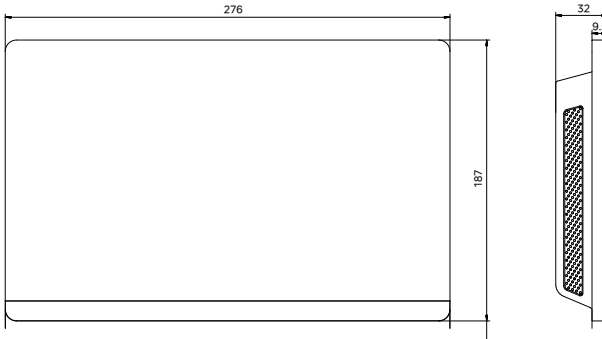

## 2) Structural dimensions of the embedded junction box

(Unit: mm) Before you drill an opening in the wall, make sure that the opening is large enough to fit in the embedded junction box.

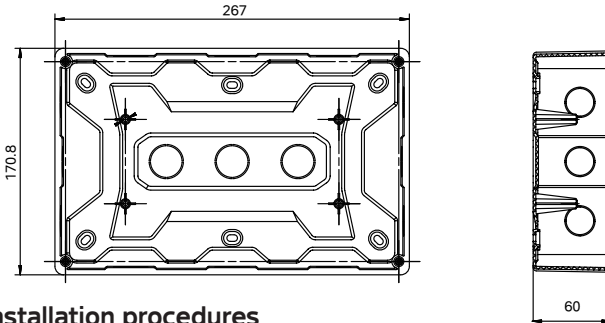

## 3) Installation procedures

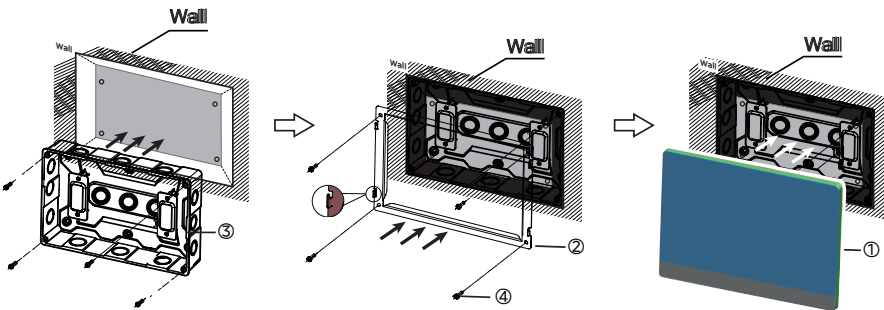

Attention: The controller is only suitable for installation at a height of  $\leq 2m$ .

1

### 1. Mount the embedded junction box

Mount the embedded junction box within the wall. Ensure that the outer surface ③ of the embedded junction box is level with the wall surface.

2

### 2. Install metal parts

Make sure the hooks of the metal parts face upwards. Use 4 screws ④ provided as accessories to secure it on the installation base.



#### NOTE

Special note: Make sure you exert appropriate force to secure the metal parts with the screws. Excessive force may cause deformation of the four screw holes for the metal parts, making it harder to mount the metal mounting board.

3

### 3. Install TC3-10.1

Once the connections are done, place the main unit vertically on the installation base. You will feel a magnetic force at this point. Exert force downwards to mount it on the metal part.

## Product Description

TC3-10.1 touch screen centralized controller [hereinafter referred to as "centralized controller"]

provides centralized management functions for VRF units.

It is compatible with all V8 series units, that is, V8 ODUs and V8 IDUs.

The product supports 6 RS-485 buses, and each RS-485 bus can be connected to up to 8 V8 refrigerant systems (8 refrigerant systems can have a maximum of 64 IDUs), that is, a centralized controller can be connected to a maximum of 48 refrigerant systems (48 refrigerant systems can have a maximum of 384 IDUs).

Note: In actual projects, an RS-485 bus may fail to be connected to 8 refrigerant systems or 64 IDUs in full. One TC3-10.1 may fail to be connected to 48 refrigerant systems or 384 IDUs in full.

Example 1: 0# refrigerant system has 20 IDUs, 1# refrigerant system has 30 IDUs, and 2# refrigerant system has 14 IDUs. As the 3 refrigerant systems have a total of 64 IDUs, the RS-485 bus cannot be connected to additional systems (now there are less than 8 refrigerant systems);

Example 2: The 8 refrigerant systems have a total of 40 IDUs (5 each for refrigerant systems 0# to 7#). The RS-485 bus cannot be connected to additional systems because it has been connected to 8 refrigerant systems (now there are less than 64 IDUs).

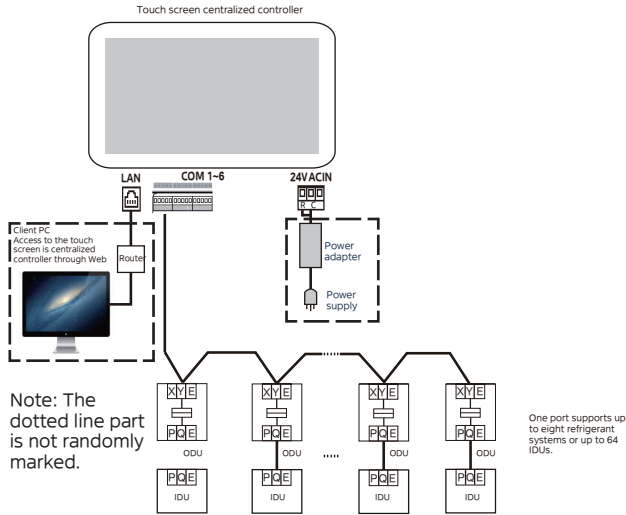

Note: There may not be a PQE interface between an IDU and an ODU. For details, refer to the manual of ODU and IDU. This is only used to illustrate the centralized controller framework.

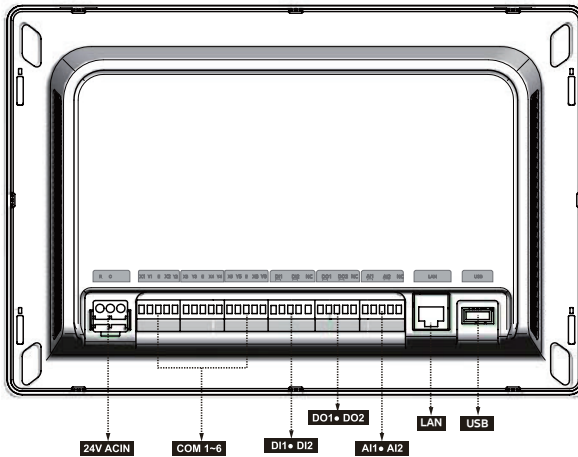

### ⚠ Caution

- The TC3-10.1 is installed at one end of the M-net communication bus. Do not install it in the middle of the bus.
- You need a three-core shielded cable of 0.7~1.0 for the signalling wires. For details, please consult a professional technician.
- The controller is only suitable for installation at a height of  $\leq 2\text{m}$ .

Port	Function
RC	Power interface, 24V AC, 1A
X1 Y1 E X2 Y2 X3 Y3 E X4 Y4 X5 Y5 E X6 Y6	X1 Y1 E is the 1st RS-485 bus, X2 Y2 E is the 2nd RS-485 bus, X3 Y3 E is the 3rd RS-485 bus, X4 Y4 E is the 4th RS-485 bus, X5 Y5 E is the 5th RS-485 bus, and X6 Y6 E is the sixth RS-485 bus. Each RS-485 bus interface can be connected to eight V8 refrigerant systems (up to 64 IDUs). Note: Two RS-485 buses share one E port. Note: The X port and Y port of the centralized controller are connected to the X port and Y port of the ODU, respectively. When multiple refrigerant systems are connected, they need to use different addresses.
DI1, DI2	Reserved
DO1, DO2	Reserved
AI1, AI2	Reserved
LAN	Provides Web functions, and the Web implements functions similar to those on the touch screen. When a computer accesses the centralized controller through the Web, it is necessary to ensure that the computer and the centralized controller are on the same network segment. Note: Some functions are only available on the touch screen, not on the Web.
USB	USB 2.0 port: connected to a USB disk in FAT32 format, and used for some functions of the centralized controller. (such as upgrading the centralized controller firmware)

Power Supply Specifications	Voltage	24V AC, 1A, 50/60Hz
	Power consumption	Max. 24W
Operation Conditions	Voltage fluctuations	Rated value+/-10%
	Operating ambient temperature	-10°C~+50°C
	Storage temperature	-20°C~+60°C
	Operating ambient humidity	RH25%~RH90%
Dimensions	Unit (mm)	276(W)*187(H)*32(D)
Weight		0.76 kg

# 1 Initial Use

Before using the unit for the first time, read the following content carefully and operate and set the centralized controller according to the prompts, so that you can fully understand how to use the basic functions of the centralized controller and correctly

\* The functions supported by the centralized controller (including function details) will be increased with product updates. Due to the update cycle and other reasons, some function details in the manual may be inconsistent with the actual product, such as interface screenshots, display parameter names, etc., and the actual product shall prevail.

## 1.1 Connection with VRF System

The centralized controller has six RS-485 bus interfaces (X1/Y1/E, X2/Y2/E, X3/Y3/E, X4/Y4/E, X5/Y5/E, X6/Y6/E). Each RS-485 bus interface can be connected to eight refrigerant systems (up to 64 IDUs). When multiple refrigerant systems are connected to one RS-485 bus interface, connect the X port of the master ODU of multiple refrigerant systems in series and connect it to the X port of the centralized controller; connect the Y port of the master ODU of multiple refrigerant systems in series and connect it to the Y port of the centralized controller; then connect the E port of the master ODU of multiple refrigerant systems in series and connect it to the E port of the centralized controller.

After the connection between the VRF unit and the centralized controller is completed (X/Y/E wiring) and the VRF unit is operating normally, turn on the power of the centralized controller to enter the software debugging mode.

## 1.2 Language Selection upon Initial Power-on

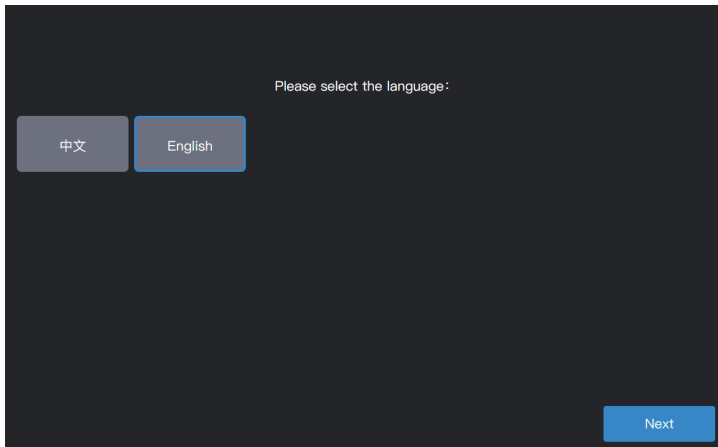

When the centralized controller is powered on for the first time, select the display language of the centralized controller.  
After selecting the language here, you can re-select the interface display language of the centralized controller through the language option in "Settings".

\*The languages supported by the centralized controller may increase with the product update. The screenshots in the manual are only for function description, and the actual product shall prevail.  
\*You may directly enter the login interface of individual centralized controllers due to factory random inspection. You can re-select the interface language of the centralized controller through the language option in "Settings".

### 1.3 Login

Select the language and enter the login interface as follows:

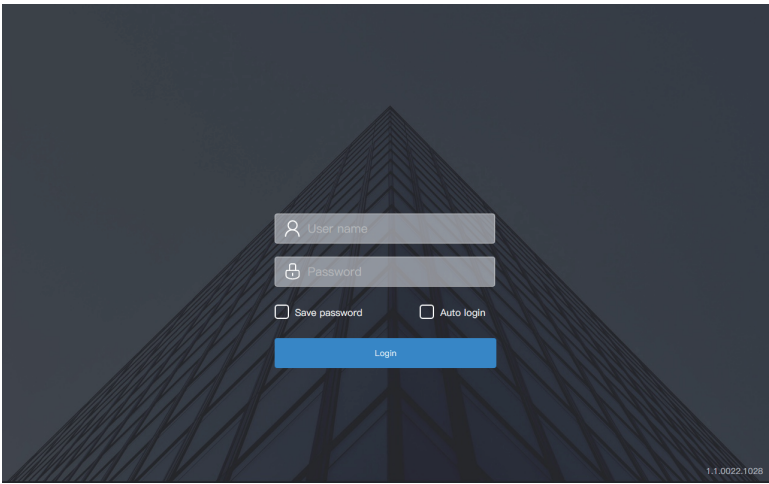

Debugging account: admin; debugging password: 123456  
Enter the account number and password, and click "Login" to log in to the centralized controller.



	Entry of the Settings interface (upper right corner)
	Overview of device status: power-on, power-off, disconnection, and failure, and statistics on the number of devices; the list diagram shows general parameters.
	Device monitoring: view device status (card form, list form), managed groups, managed devices, control devices, etc.
	Schedule management: View, edit, and modify schedules.

## 1.4 Search (Topology)

A device search is required to display the refrigerant systems connected to the centralized controller.

\* The centralized controller must meet the requirements for the following two periods of time before conducting "Device search"

Time 1: Time taken to wait for the VRF refrigerant system to run properly (about 15 minutes, depending on the actual refrigerant system).

When the refrigerant system is powered on, system detection will take some time. During this period, the centralized controller may obtain incorrect information about the refrigerant system. If you conduct "Device search" at this moment, the information about the refrigerant system obtained by the centralized controller will be incorrect (model identification failure, improper set temperature range, and insufficient VRF units, etc.).

Time 2: time of communication between the centralized controller and VRFs (depending on the number of connected refrigerant systems, about 5 minutes). It takes more than 5 minutes for the centralized controller to connect with the properly running VRF system. If you conduct a "Device search" before this, the information about the refrigerant system obtained by the centralized controller will be abnormal (model identification failure, improper set temperature range, and insufficient VRF units, etc.).

Steps: Power on the centralized controller 15 minutes after the communication cables are connected and the VRF system is powered on. Wait 5 minutes, and search for the device.

Click the "Setting" function icon  in the upper right corner to enter the "Setting" interface, as shown in the figure below:

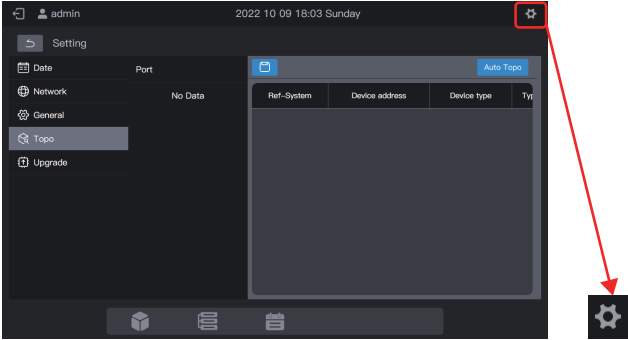

Click "Topo" in the left menu and "Auto Topo" in the right area. The centralized controller will start to obtain information about the refrigerant system connected to the centralized controller and automatically construct the topological relationship. After this, the interface will appear as follows:

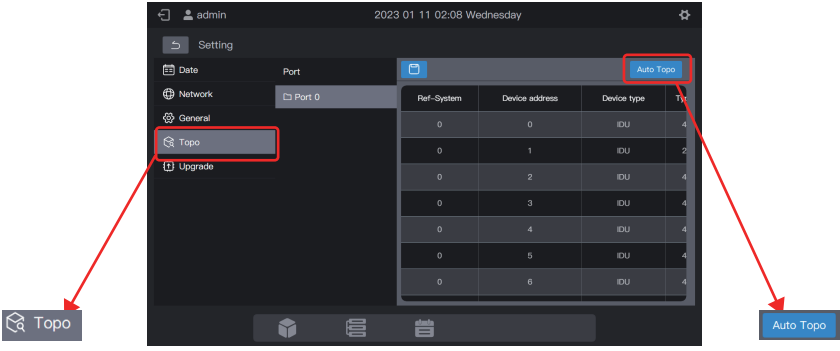

Parameter	Remarks
<b>Ref-System</b>	Refrigerant system address, automatically generated after search, unmodifiable
<b>Device address</b>	Device address, automatically generated after search, unmodifiable IDU: 00-63, ODU: 96-99 (master unit 96, slave units 1-3 correspond to 97-99, respectively)
<b>Device type</b>	Device type (IDU or ODU), automatically generated after search, unmodifiable
<b>Type</b>	Device model code, automatically generated after search, unmodifiable For details about the mapping between models and codes, see "Model Information" in the appendix.
<b>Device name</b>	Device name in the centralized controller, modifiable The following names are displayed by default: IDU: "IDU_Port_System_IDU Address" ODU: "ODU_Port_System_ODU Address"
<b>Fan(W)</b>	Power of IDU fan, modifiable
<b>EH(W)</b>	Power of IDU auxiliary heater, modifiable

Click the parameter information to be modified ("Device name", "Fan(W)", "EH(W)"), and finally click  to save.

\* Causes for the failure of the centralized controller to locate the device.

1. The preconditions of TC3-10.1 and the **"Precautions"** at the beginning of this chapter are not met.  
Solution: Re-power on the TC3-10.1 centralized controller. After the preconditions are met, search for the device again.
2. During power-on of TC3-10.1, the system address, IDU address and other information of the refrigerant system have been modified.  
Solution: Re-power on the TC3-10.1 centralized controller. Wait 5 minutes and search for the device again.

For other matters, please consult relevant technical support personnel.

The following chapters will use examples to describe how to use TC3-10.1 to manage devices.

### 1.5 Modification of Device Name

The device name can be modified in two ways.

**Mode 1:** Modify the device name on the "Topo" interface.

In the "Setting" - "Topo" interface, directly click the cell with a device name that needs to be modified in the "Device Name" column, enter the name to be modified, and click  in the upper right corner to save the modified information.

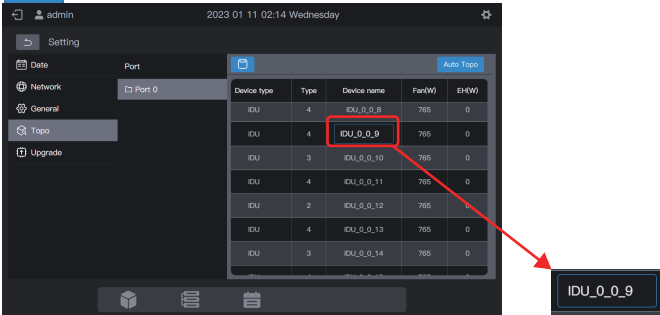

**Mode 2:** Modify the device name on the "Device monitoring" interface.

1. Click  to enter device monitoring, and click "Device".



2. Select the device you want to modify, click .

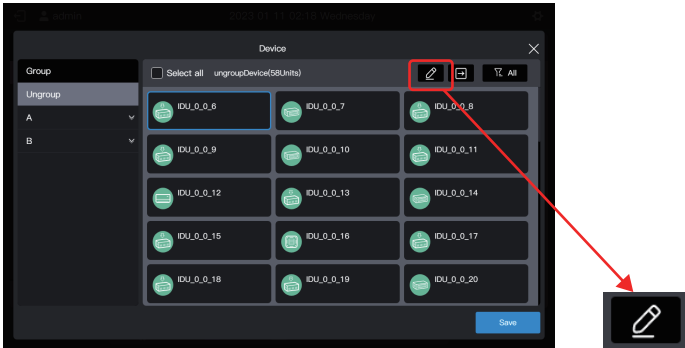

3. Enter a name in the pop-up box, such as "Test name", and click "Save".

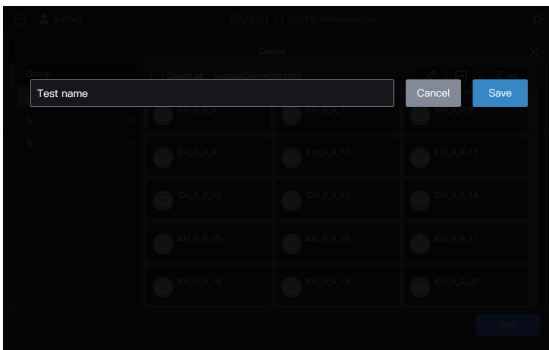

4. Click "Save".

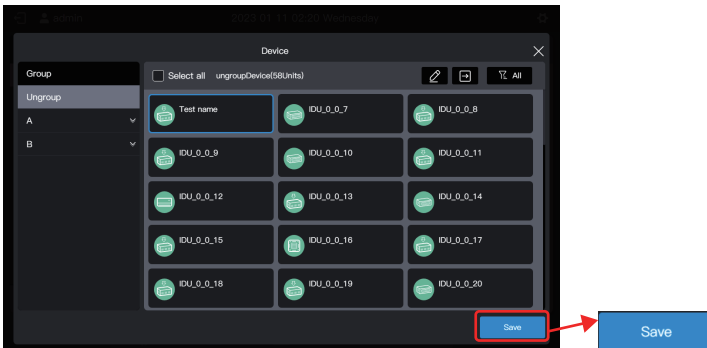

5. The device name has been modified.



## 1.6 Group Function Examples

The centralized controller supports level-3 groups, through which the devices can be managed conveniently. In the example, the groups are divided according to their physical locations.

Connect the centralized controller to all the refrigerant systems in Buildings A and B.

Building Name	Floor Name	Room Name	IDU Name
A	A-1	A-101	A101
	A-1	A-102	A102
	A-2	A-201	A201
	A-2	A-202	A202
B	B-1	B-101	B101
	B-2	B-202	B202

In the following example, the IDU name has been modified based on the requirements in the above table. For modification of the device name, refer to "1.5 Modifying a device name".

### 1.6.1 Creating a group

Click "Group" to enter the group function interface:



### Create a level-1 group.

Click "Add group" in the first column to create a level-1 group: A, B

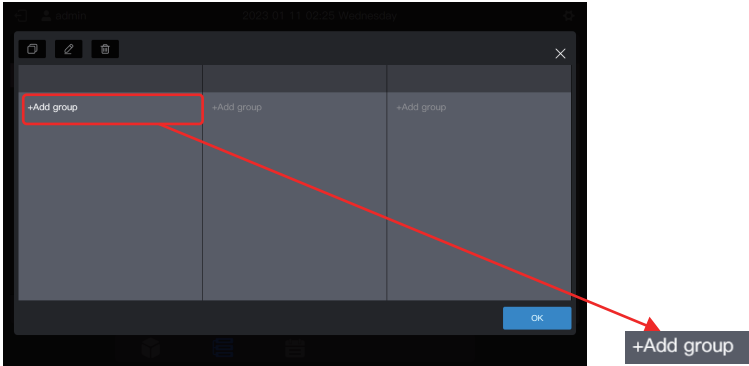

In the pop-up interface, enter the level-1 group name A, click "Save", repeat the above steps, and create B.

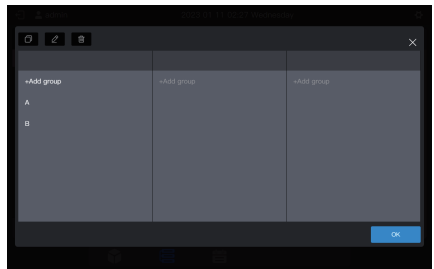
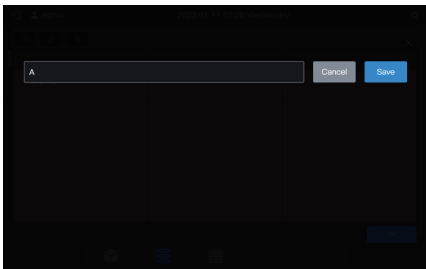

### Create a level-2 group.

Select "A" and click "Add group" in the second column to create level-2 groups of A: A-1 and A-2.

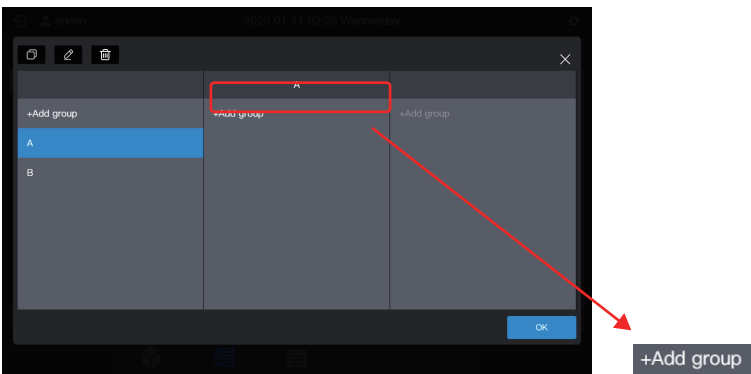

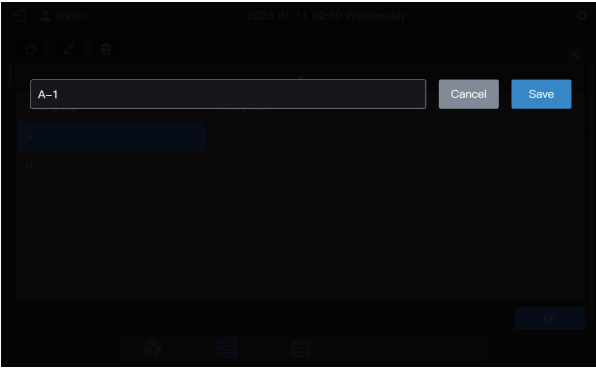

Follow the same steps to create a level-2 group of B: B-1.

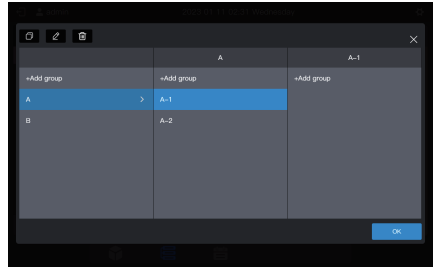
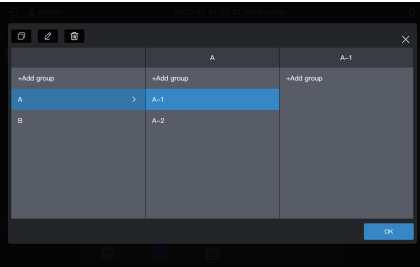

### Create a level-3 group.

Select "A", click "A-1", and click "Add group" in the third column to create level-3 groups of A: A-101 and A-102.

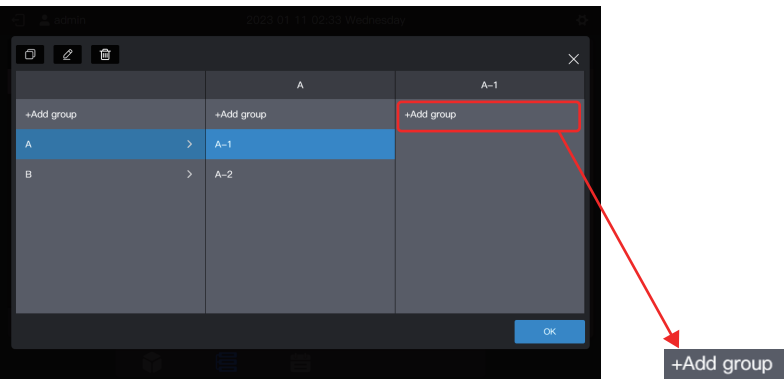

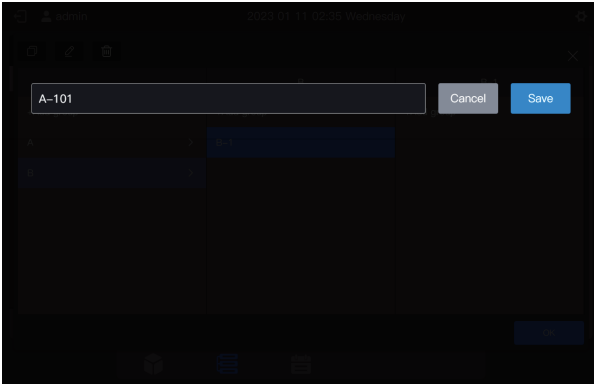

Follow the same steps to create other level-3 groups.

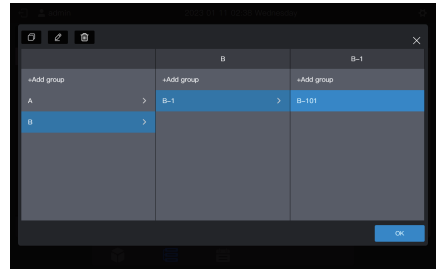
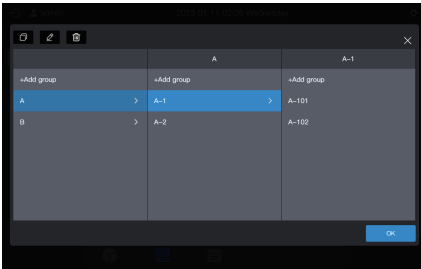

**The group is now created.**

Click "OK" to submit all group information.

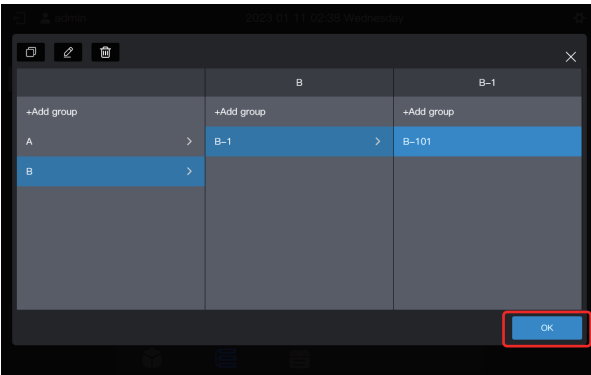

Note: Before clicking "OK", no operations will be saved. If you do not click "OK" but click the X in the upper right corner, all changes will be lost.

## 1.6.2 Adding a device to a group

Enter the "Device" interface.



Select the IDU to be removed from the group.

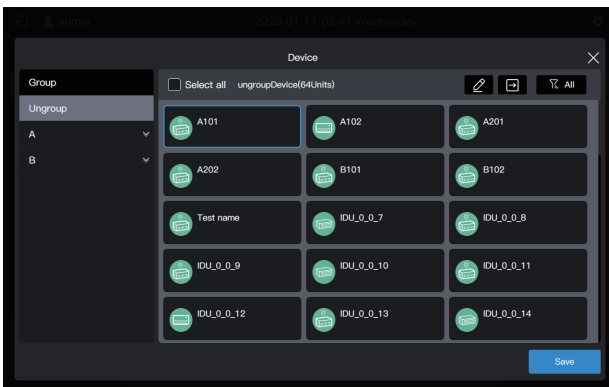

Note: Immediately after the centralized controller is debugged, all IDUs are in "Ungroup".

Select the desired group to accept the air conditioner.

Click  , and select the target group to be moved in the group information that slides out on the right.

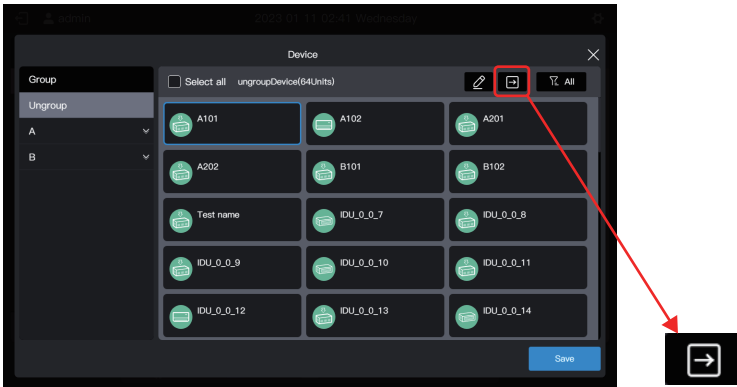

The target group is A-101. Click "OK".

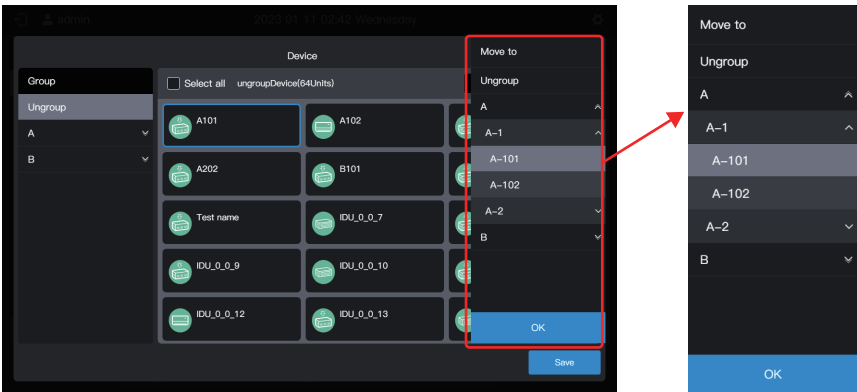

Check whether the move is successful through the group on the left. For example, click Group A-101 to check whether the A101 air conditioner exists.

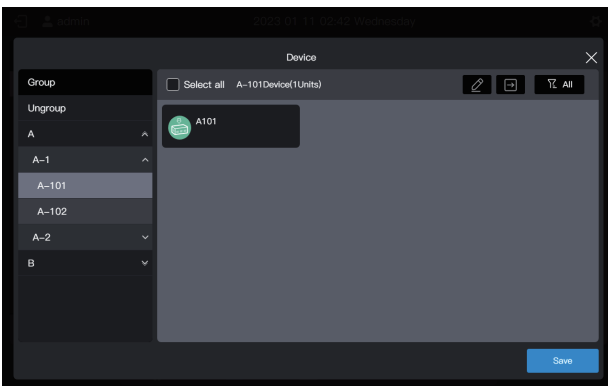

Note: This operation has not yet taken effect, and you need to click "Save" to make it take effect.

## Save the settings.

Repeat the above steps to move all air conditioners to the desired group, and click "Save" to make the move take effect.

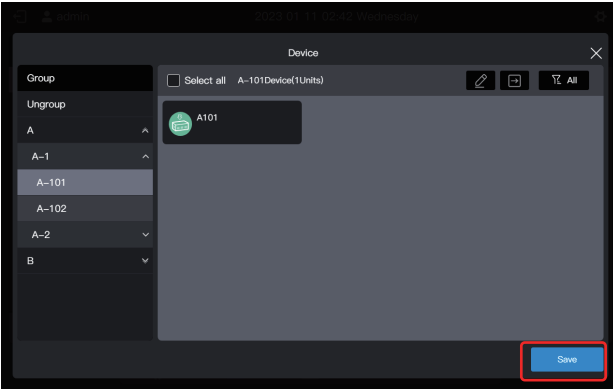

Note: No operations will be saved until you click "Save". If you click "X" in the upper right corner rather than "Save", all changes will be lost.

## 1.7 Control Device

The centralized controller can be used to set the operating parameters, locking attribute, etc. of the device.

### 1.7.1 General control

Select the IDU to be controlled (click to select, then click again to deselect), such as B101 IDU (the blue box indicates that the IDU is selected):



Click  , in the pop-up control window, and select the required parameters on the control parameters:

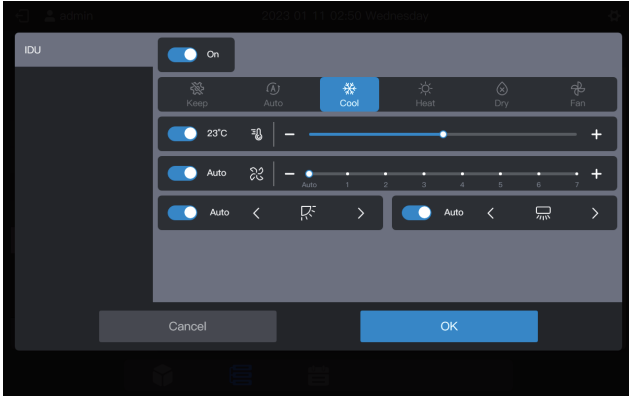

Note: If the IDU does not support single attribute setting, "keep" cannot be selected for any parameter. (Consult the technical staff about whether the specific model supports a single attribute)

Note: The control parameters displayed on the interface may exceed the actual

### 1.7.2 Locking attribute

Select the IDU to be controlled (click to select, then click again to deselect), such as B102 IDU (the blue box indicates that the IDU is selected):



Click  , in the pop-up locking window, and select the required parameters on the control parameters:

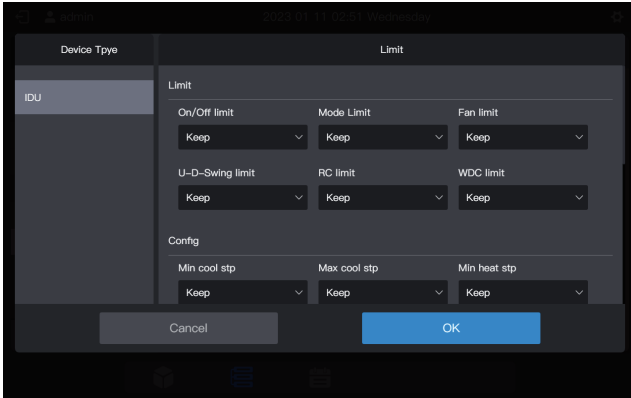

Note: The locking parameters displayed on the interface may exceed the actual lockable parameters of the IDU. When this parameter is selected, the actual IDU does not operate.

## 1.8 Schedule Function Examples

The schedule function enables IDUs to be powered on and off as planned. The following example introduces the use of schedule management:

Schedule Expiry Date	Date	Schedule Command	Control Object
2022-01-01~2022-12-31	Monday to Friday	Power-on at 8:00 Power-off at 18:00	A101, A102, A201, A202
	May 1 to May 3	Power-on at 9:30 Power-off at 17:00	

The specific steps are as follows:

Step	Description
1	Create a holiday template (to run different power-on/off schedules from May 1 to May 3)
2	To create a schedule, the holiday template created in the previous step will be used. If there is no special date in the actual demand, you can directly create a schedule without creating a holiday template.

Click  to enter the schedule function.

## 1.8.1 Creating a holiday template

A holiday template is a 1-day schedule command template that is referenced in the schedule.

### Step 1: Create a holiday template

Click "Holiday template" to enter the template settings, then click  to create "Holiday template":

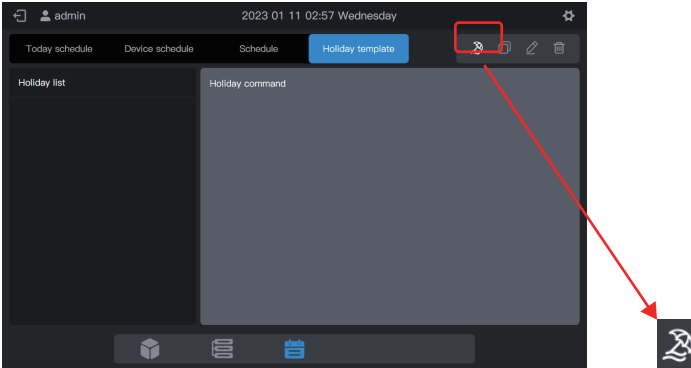

In "Name", enter a name such as "5.1 - 5.3". In "Device type", select according to the actual situation. Here, select "IDU".

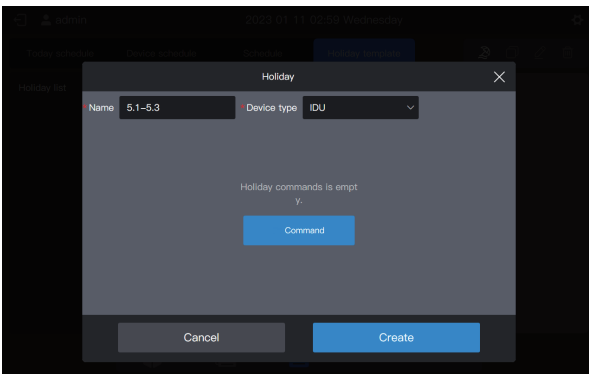

### Step 2: Create a schedule command

Click "Command" to create the execution plan of the template. For example, during the Labor Day holiday, power on the system at 9:30 am. Click "OK" to save the command.

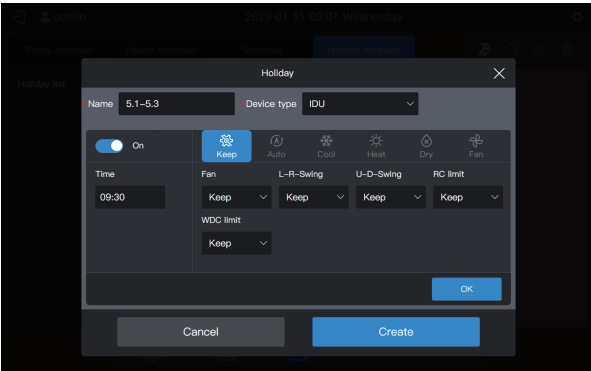

Click "Command" to create a 17:00 power-off schedule.

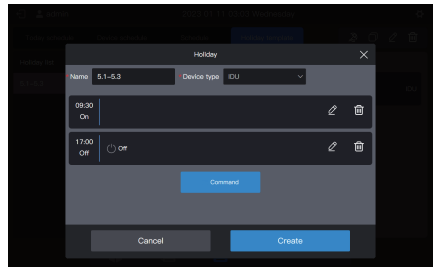
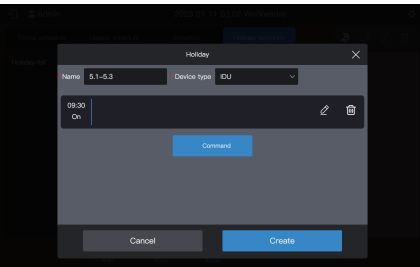



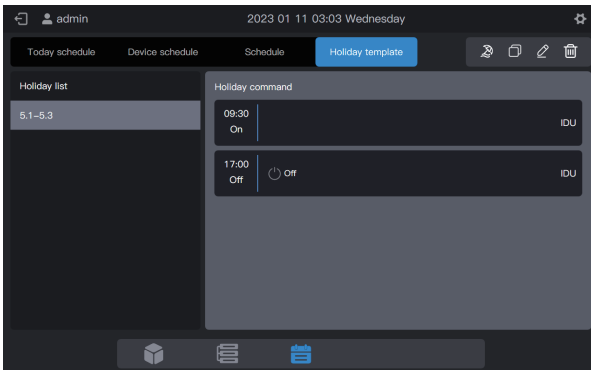

Click "Create", and return to the schedule function interface to see the created holiday template.



Note: As you may have noticed, the system does not determine the date for the execution of the holiday template. The holiday template is created by following the above steps, but it is not used. The template needs to be used in the schedule. The system will specify the date on which the template is executed only if the holiday template is used.

## View, edit, delete or copy the holiday schedule

In the holiday template interface, click the holiday schedule in "Holiday Schedule List" on the left to view the specific schedule template information on the right. Click the function button in the upper right corner to operate the holiday schedule.

Icon				
Function	Create a holiday schedule	Copy the selected holiday schedule	Edit the selected holiday schedule	Delete the selected holiday schedule

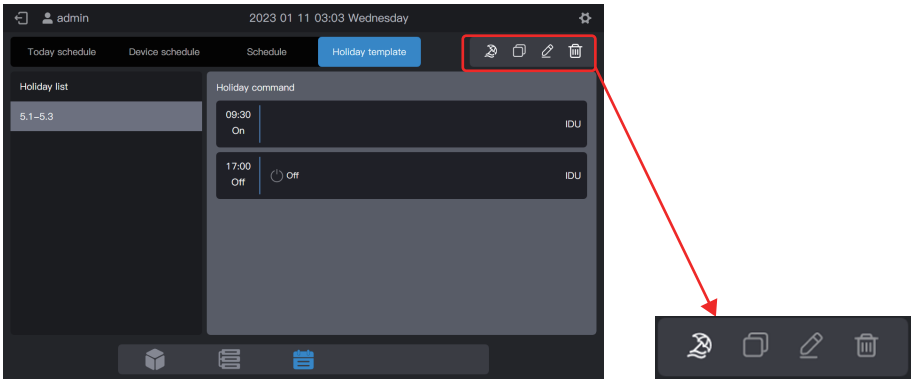

## 1.8.2 Creating a schedule

### Step 1: Create a schedule

Click  to create a "Schedule".

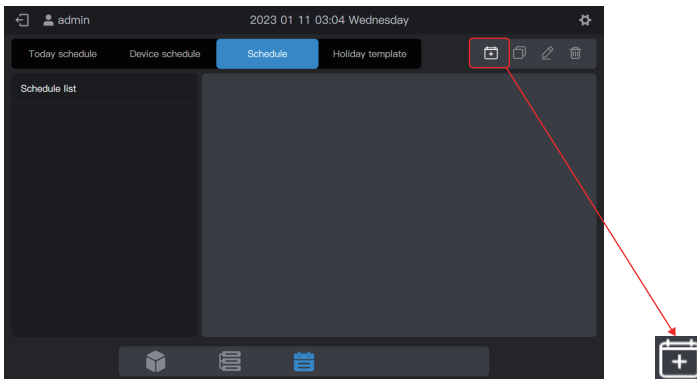

Please complete the basic information of the schedule.

Item	Content	Item	Content
Name	Work Time	Start	2022-01-01
Type	IDU	End	2022-12-31

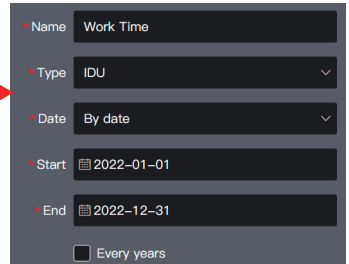
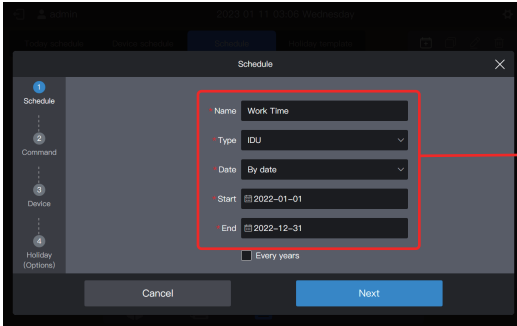

### Step 2: Create a schedule command

Click "Next" to create a schedule command

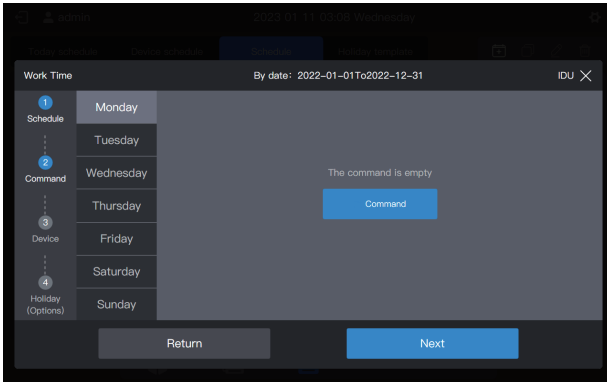

Click "Command" to create the command to be executed. Upon creation of a command, click "OK" to save the command (same as the operation in the holiday template).

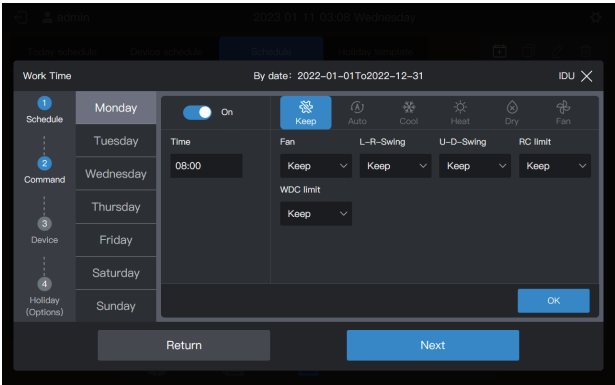

Create two schedule commands: power on at 8:00 and power off at 18:00.

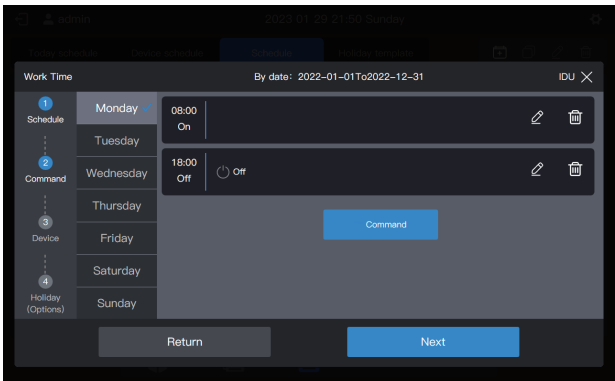

For example, click "Tuesday" to set the schedule for Tuesday.

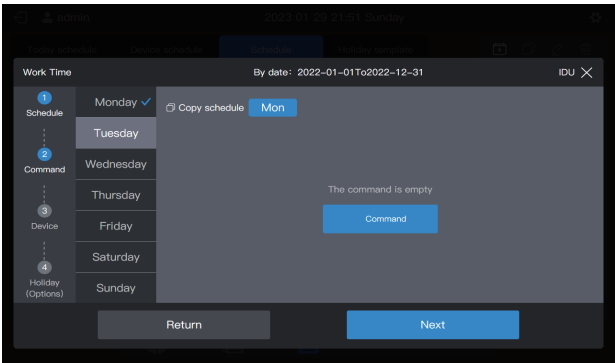

You can create schedule commands by following the steps described above. If the pre-set schedule commands are the same, click "Mon" or any other day after "Copy schedule" to copy the schedule command for the selected day.

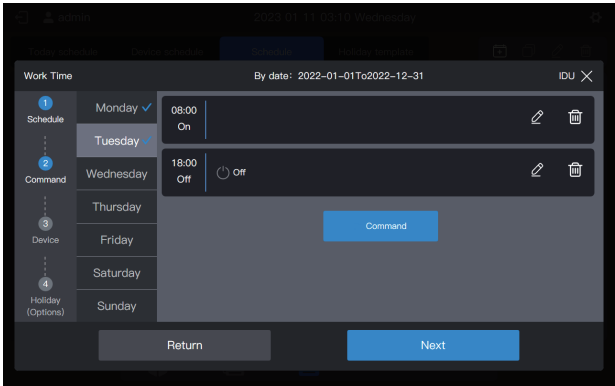

Note: If no schedule command is set for a certain day, the schedule for that day will not be executed. In this example, no schedule command is set for Saturday or Sunday, as shown below:

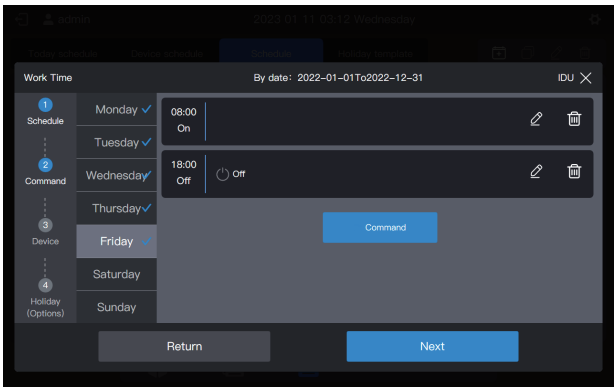

**Step 3: Select the device to execute the schedule**

Click "Next", and select the device to execute the schedule. Here, select A101, A102, A201 and A202 IDUs.

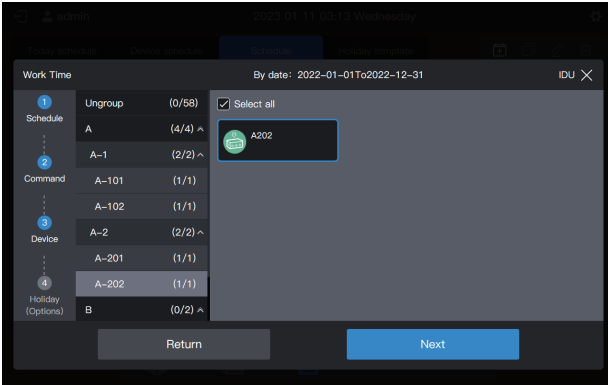

#### Step 4: Create a schedule command

Click "Next" to enter the "Holiday" setting interface.

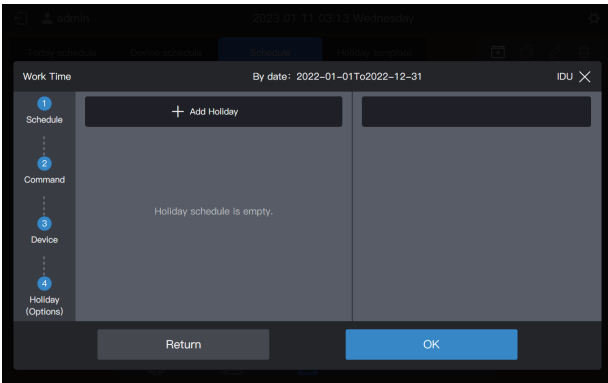

A schedule supports multiple holiday schedule cards. The system executes the schedule commands in the "Holiday Template" on the specified date, instead of the schedule commands in the schedule. As required at the beginning of the example, during the Labor Day holiday, the system should be powered on at 09:00 instead of 08:00 as planned in the schedule and powered off at 17:00 instead of 18:00 as planned in the schedule.

Click "Add holiday". A holiday schedule card will appear on the interface. Set the "Start" date to 2022-05-1 and the "End" date to 2022-05-03. For the "Holiday Template", select "5.1 - 5.3".

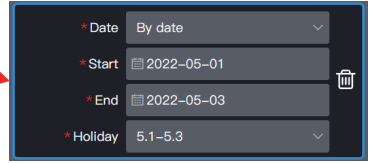
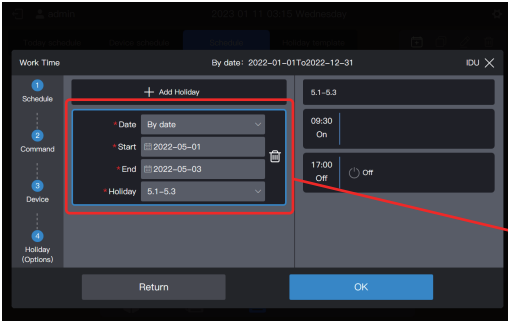





Note: If no "Holiday template" is available, you can save the schedule. After a "holiday template" is created, edit the schedule again and add the corresponding holiday template.

Note: If a "Holiday schedule" card is available and the "Holiday template" is selected as "No template", the schedule will not be executed on the corresponding date.

### View, edit, delete or copy the schedule

In the schedule interface, click the schedule in the left "Schedule list" to view the specific schedule information on the left. Click the function button in the upper right

Icon				
Function	Create a schedule	Copy the selected schedule	Edit the selected schedule	Delete the selected schedule

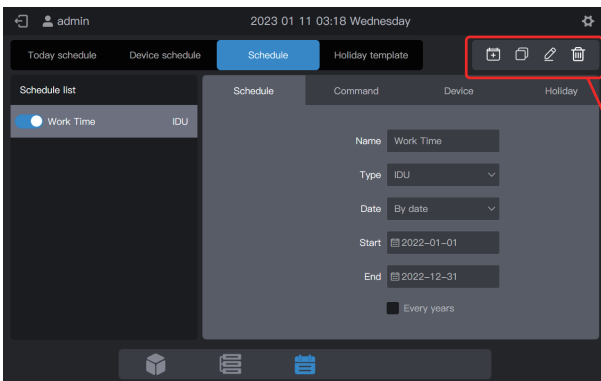

## 2. Function Description

### 2.1 Homepage



View the status distribution and general parameters of IDUs. When there are multiple types of access devices, you can view the status of different types of devices through "Device Type".

### 2.2 Group and Device Management



Function Module	Function
Group	Access to group management; creation, deletion, and editing of three-level group management
Device	Access to group management 1. Change the IDU name. 2. Change the group to which the IDU belongs.

## 2.2.1 Group management

### 2.2.1.1 Creating a group

Click "Group" to enter the group function interface:



Create a level-1 group.

Click "Add group" in the first column to create a level-1 group: A.

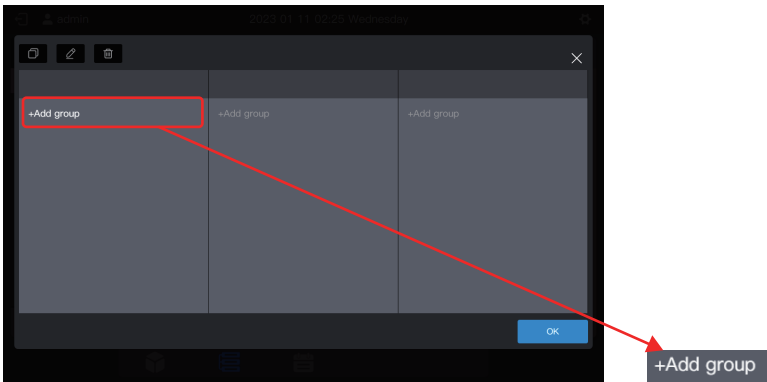

In the pop-up interface, enter the name of the level-1 group, A, and click "Save".

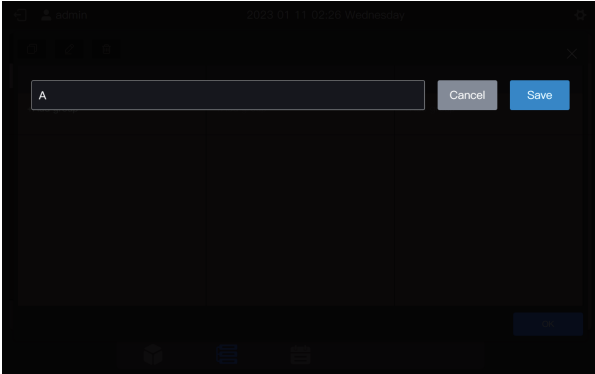

**Create a level-2 group.**

Select "A" and click "Add group" in the second column to create level-2 groups of A: A-1 and A-2.

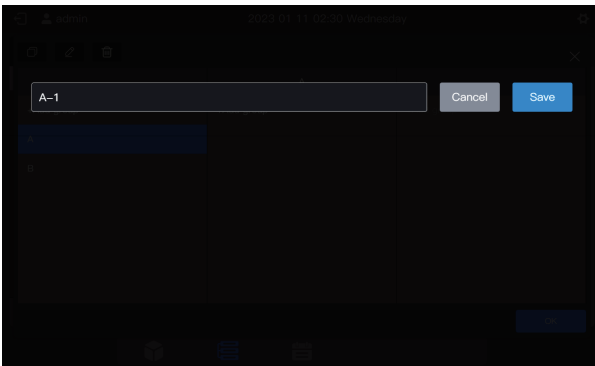
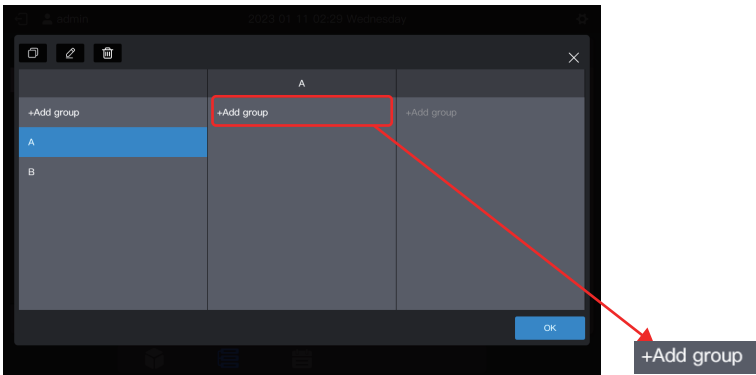

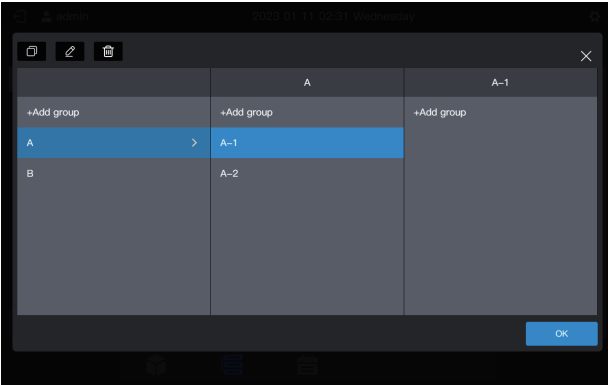

### Create a level-3 group.

Select "A", click "A-1", and click "Add group" in the third column to create level-3 groups of A: A-101 and A-102.

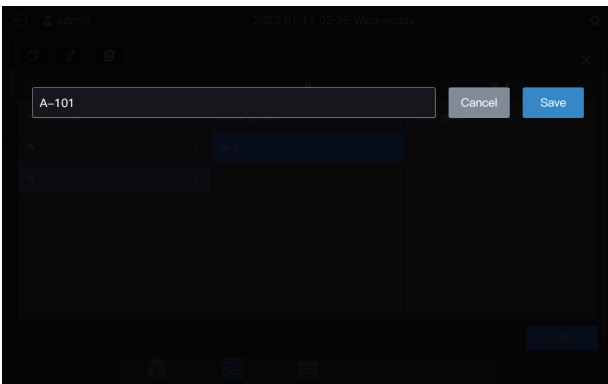
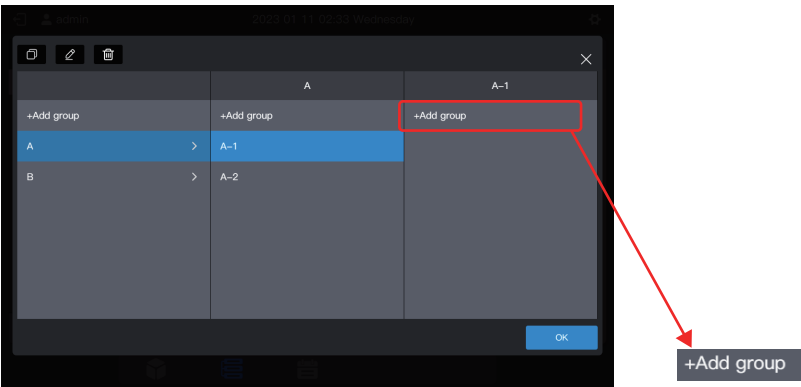

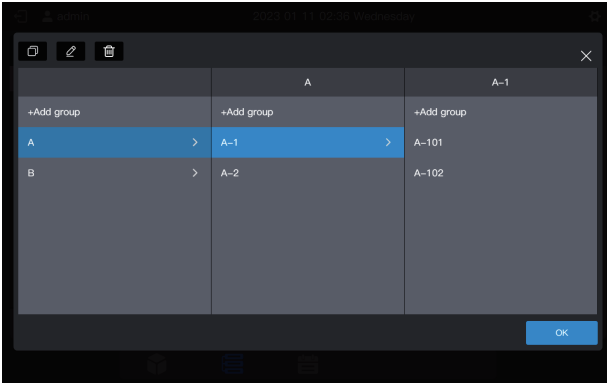

**The group is now created.**

Click "OK" to submit all group information.

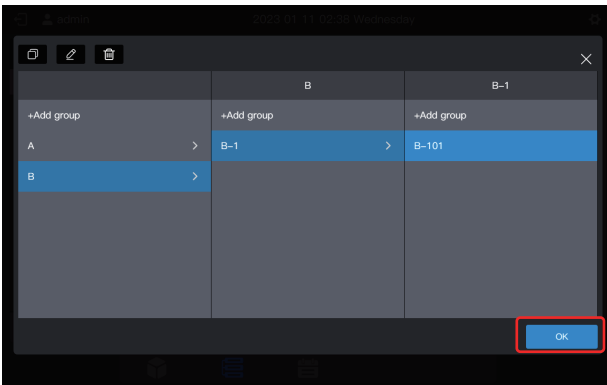

Note: Before clicking "OK", no operations will be saved. If you do not click "OK" but click the X in the upper right corner, all changes will be lost.

### 2.2.1.2 Modifying a group name

Click "Group" to enter the group function interface, select the group whose name needs to be modified, and click  .

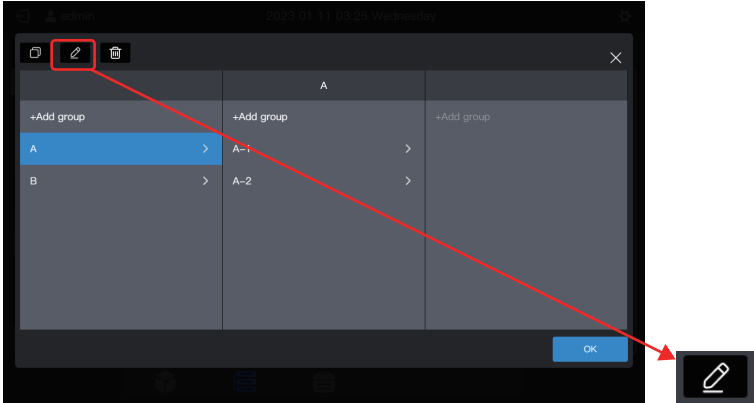

Enter the new group name A build, click "Save", return to the group management interface, and click "OK".

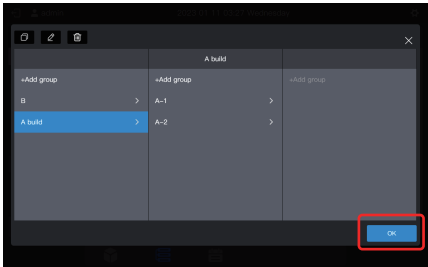
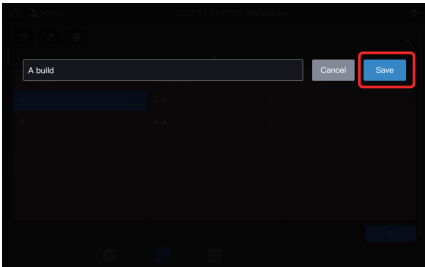

Note: Before clicking "OK", no operations will be saved. If you do not click "OK" but click the X in the upper right corner, all changes will be lost.

### 2.2.1.3 Copying a group

Click "Group management" to enter the group function interface, select the group to be copied, such as A build, and click  .

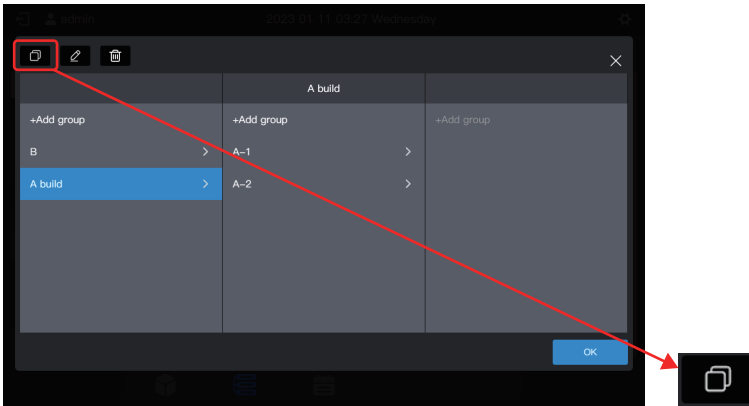

The default group name to be copied is: the original group name + (Copy).

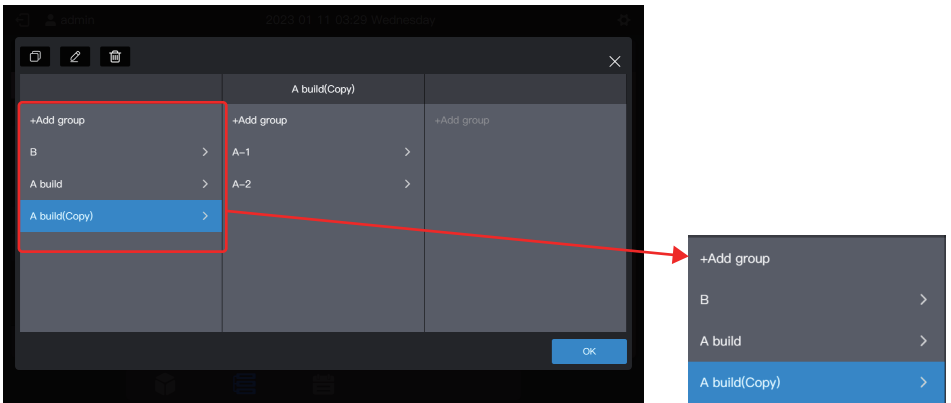

Note: Copying a group will also copy its sub-groups. This makes it more convenient to create groups in projects with similar groups.

Note: Before clicking "OK", no operations will be saved. If you do not click "OK" but click the X in the upper right corner, all changes will be lost.

### 2.2.1.4 Deleting a group

Click "Group management" to enter the group function interface, select the group to be copied, such as A build (Copy), and click  .

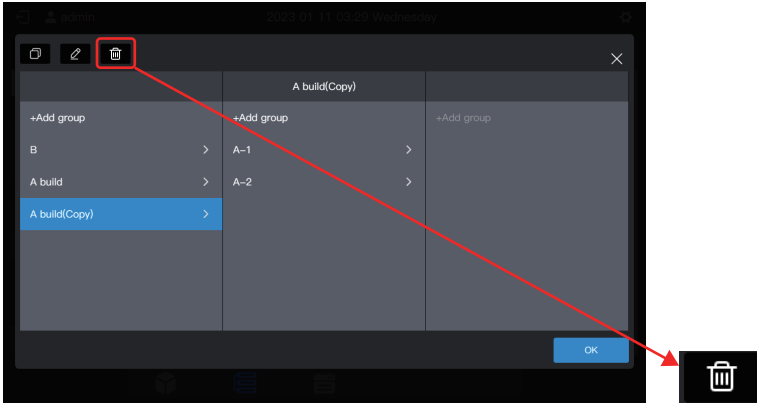

When a prompt message pops up, click "OK" to delete the group, and the IDU belonging to the group will be moved to "Ungroup":

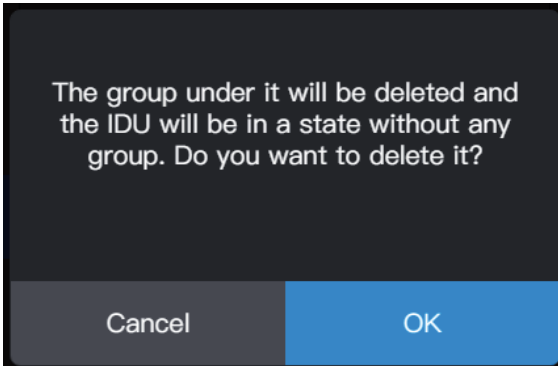

Note: Before clicking "OK", no operations will be saved. If you do not click "OK" but click the X in the upper right corner, all changes will be lost.

## 2.2.2 Device management

Click "Device" to enter the device management interface.



### 2.2.2.1 Modifying the device name

Select the IDU of which the name is to be modified, and click  .

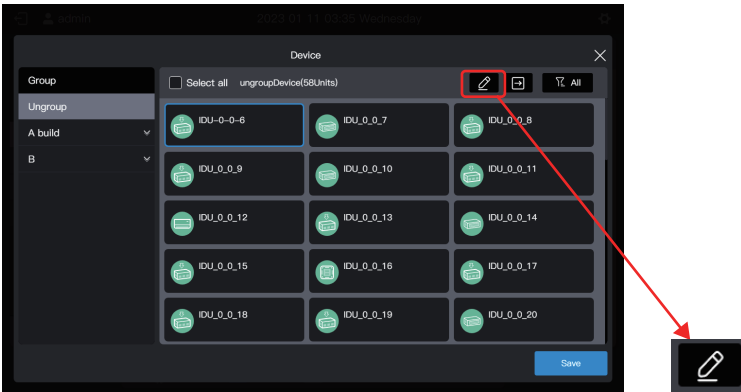

Enter the name to be modified in the pop-up window, such as "Change Name", click "Save" to return to the equipment management page, and finally click "Save" to save the modification.

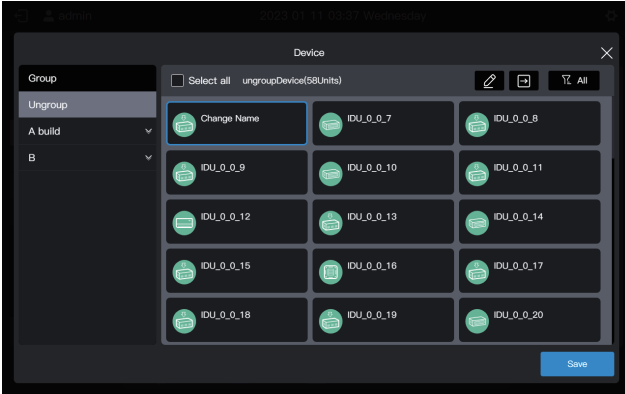
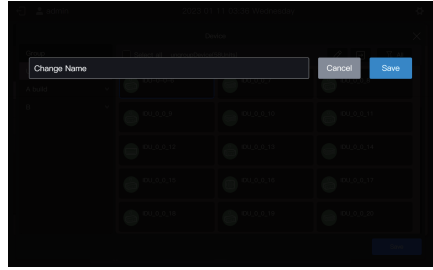
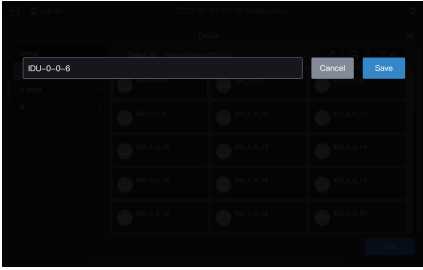

Note: No operations are saved before you click "Save". If you click "X" in the upper right corner rather than "Save", all changes will be lost.

### 2.2.2.2 Adding a device to the group

Enter the "Device" interface.



Select the IDU to be removed from the group.

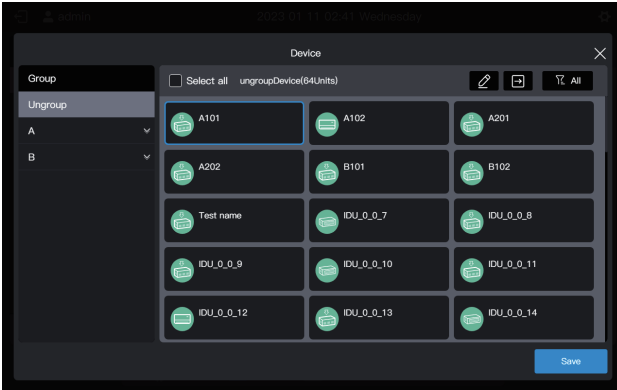

Note: Immediately after the centralized controller is debugged, all IDUs are in "Ungroup".

Select the desired group to accept the air conditioner.

Click , and select the desired group from the groups on the right.

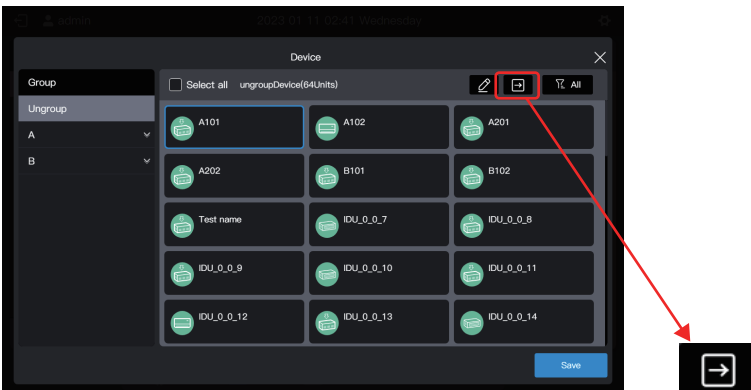

The target group is A-101. Click "OK".

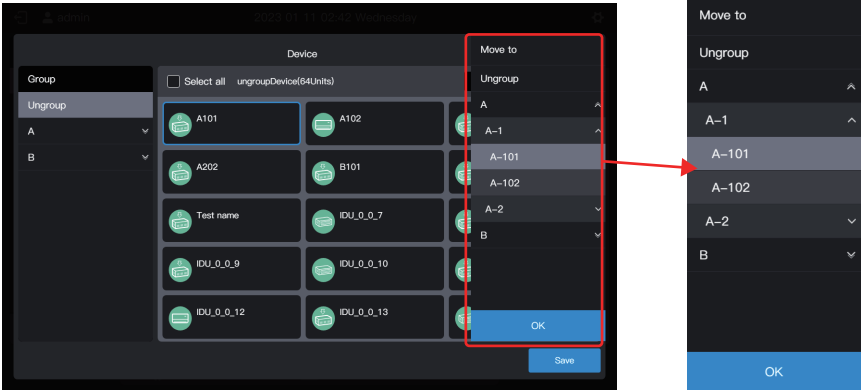

Check whether the move is successful through the group on the left. For example, click Group A-101 to check whether the A101 air conditioner exists.

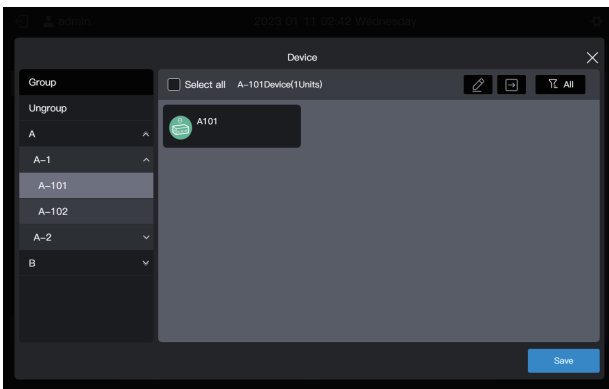

Note: This operation has not yet taken effect, and you need to click "Save" to make it take effect.

**Save the settings.**

Repeat the above steps to move all air conditioners to the desired group, and click "Save" to make the move take effect.

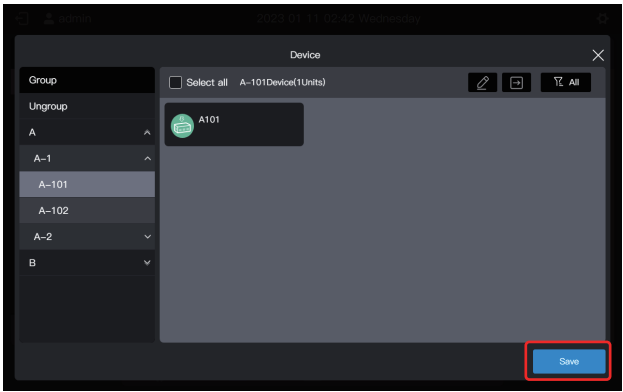

Note: No operations will be saved until you click "Save". If you click "X" in the upper right corner rather than "Save", all changes will be lost.

### 2.3 Device Monitoring



Click  to change the device display mode.

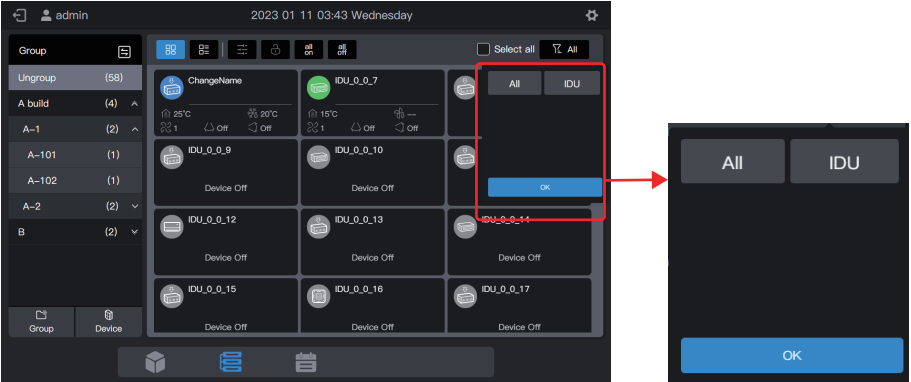

<b>Group</b>	Display the devices (only IDUs) by the created group. The default state is group display.
<b>System</b>	Display the connected devices by the centralized controller's physical port, and display the connected devices under the port by the refrigerant system. The refrigerant system contains its own IDUs and ODUs.

Click  All to switch between different types of devices.

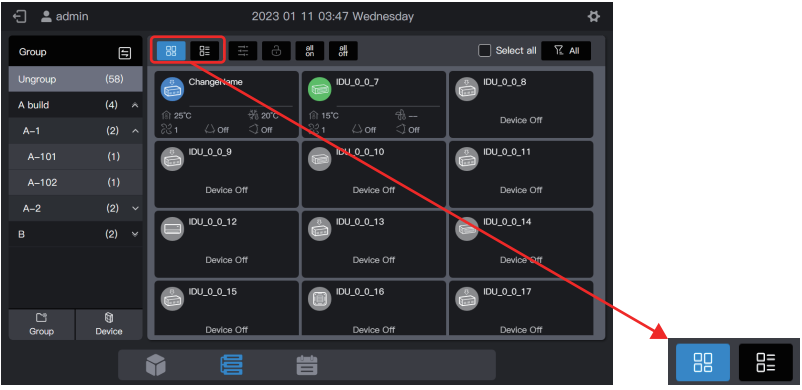

### 2.3.1 Group display



<p><b>Card</b></p>		<p>Display the devices as cards. The states are displayed more simply and intuitively.</p>
<p><b>List</b></p>		<p>Display the devices in a list. Click this icon to see more information.</p>

Whether card or list display is selected, the parameters are displayed on different pages. Pull up the page to switch to the next page. During page turning, 3 points will appear at the bottom.

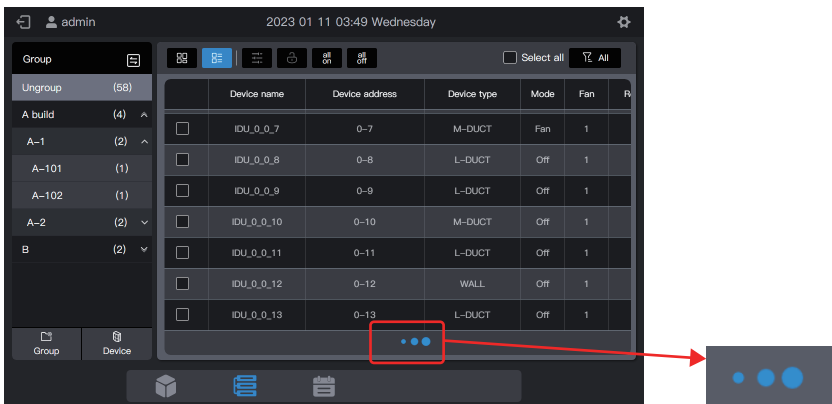
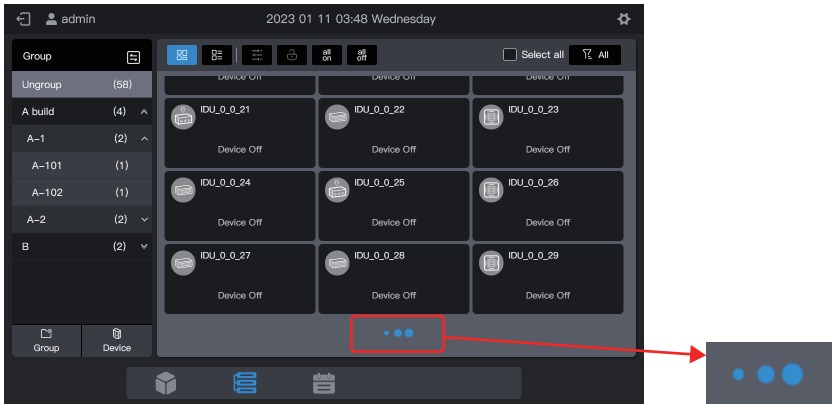

### 2.3.1.1 Card

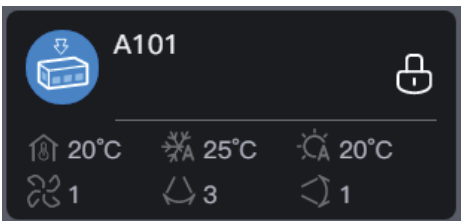

<b>Legends</b>			
<b>Description</b>	Indoor ambient temperature	Set temperature for cooling	Set temperature for heating
<b>Legends</b>			
<b>Description</b>	Operating fan speed	Swing left/right	Swing up/down
<b>Legends</b>		A101	
<b>Description</b>	Background color: IDU operating mode Model icon: IDU type	IDU Name	Any property of IDUs locked or not

Note: The above-mentioned card is only for pattern display, and does not represent the actual states of IDUs.

Note: When IDUs do not support a certain function, the legend of the corresponding area is invalid. For example, if IDUs do not support "Swing left/right", the "Swing left/right" legend is invalid.

IDU state overview:

<b>On</b>	<b>Off</b>
<b>Fault</b>	<b>Offline</b>

### 2.3.1.2 List

In the list display mode, you can see more device parameters.

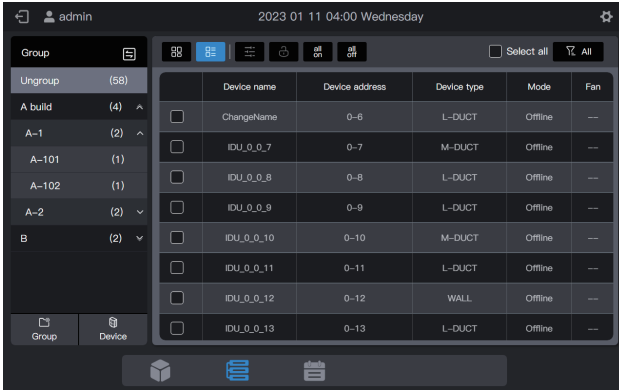

The specific parameters are related to the device type.

Note: If IDUs do not support some parameters, the values of these parameters displayed are of no practical significance. If some IDUs do not support "Swing left/right", the values displayed on the "Swing left/right" column are of no practical significance.

### 2.3.1.3 General control

In the card display state, select the IDU by clicking the IDU card.

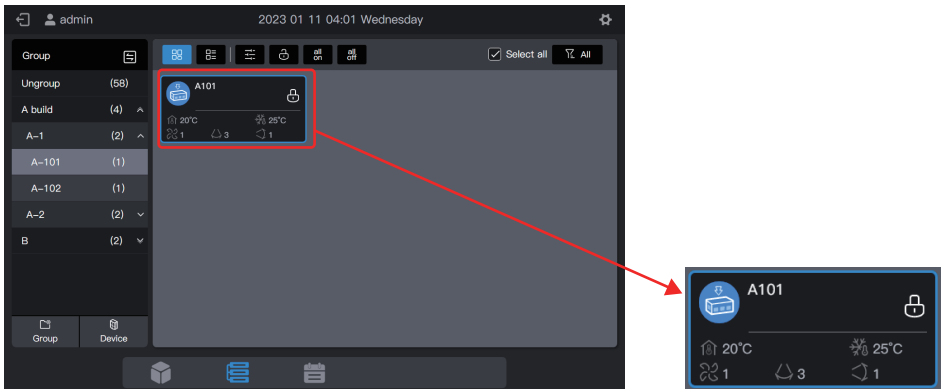

In the list display state, select the IDU by checking the selection box in the first column of the list box.

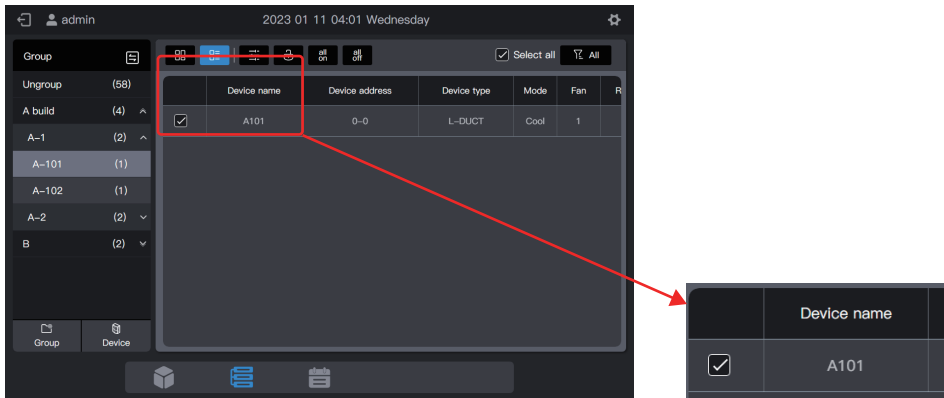

Click " [icon] " to set the operating state of IDUs.

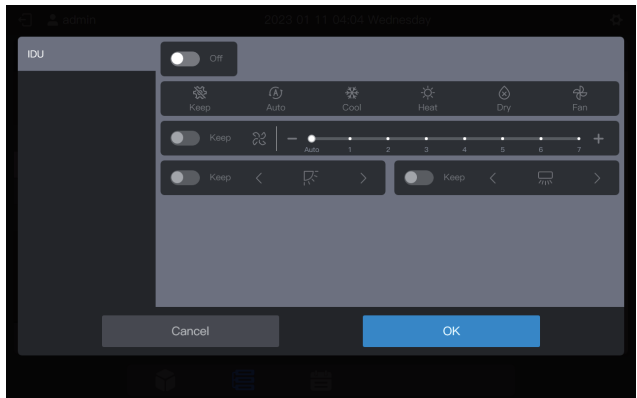

For example, you can set "Power on", "Cooling" or "21°C".

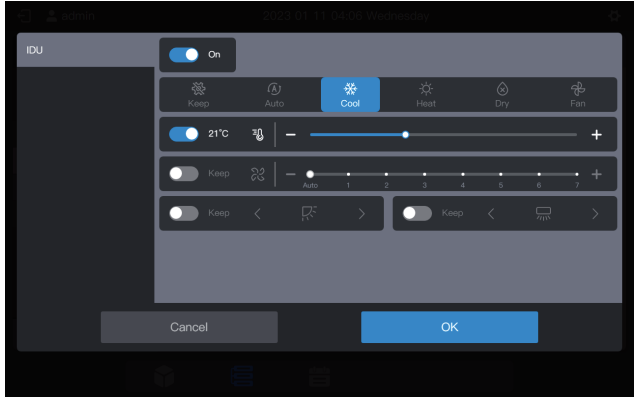

Note: When IDUs support single parameter control, you may not select other parameters. The actual operating parameters of the IDUs depend on the logic of the IDUs, which are generally those of the last operation of the IDUs.

Example:

Only the power-on parameter is selected. The values of the unselected parameters of IDUs, including the set mode, set temperature, set fan speed, and swing angle, depend on the logic of the IDUs, which are generally those of the last operation of the IDUs.

Note: If IDUs do not support single parameter control, you need to set all general control parameters at the same time. If only some of the parameters are set, unset parameters may be different from what is expected. (General control parameters of IDUs include "Set mode", "Set temperature", "Set fan speed", "Cooling temperature in auto mode", "Heating temperature in auto mode", "Swing left/right", and "Swing up/down".)

Example:

If only the "Set mode" is set to cool, "Set fan speed" is set to low fan speed, "cooling temperature in auto mode" is set to 26°C, and "heating temperature in auto mode" is set to 20°C, after the IDU receives the command, "Set temperature" may be the temperature set upon last startup or a random temperature, such as 30°C, and "Swing left/right" and "Swing up/down" may be auto swing or fixed swing angles.

Note: You must select a mode before you can change the set temperature.

Note: When a control command is sent, it takes a certain length of time for the centralized controller to refresh the latest state of IDUs. The specific time depends on the number of connected devices. (According to laboratory test data, when the connected devices are

8 refrigerant systems and 64 IDUs, the maximum polling cycle lasts for about 15 minutes. The actual duration may vary.)

## One-button power on/off

Click " " to power off all IDUs in the selected group (This operation is equivalent to the selection of IDUs before the selection of "Power off" with other parameters not selected.)

Click " " to power on all IDUs in the selected group (This operation is equivalent to the selection of IDUs before selection of "Power on" with other parameters not selected.)

Note: This is only for IDUs in the selected group, excluding those in the subgroups of the selected group.

Note: If any IDU that does not support single parameter control exists in the system, the one-button power on/off function can lead to inconsistency between the operating parameters of that IDU and what is expected.

### 2.3.1.4 Extended parameters (lock, etc.)

In the card display state, select the IDU by clicking the IDU card.

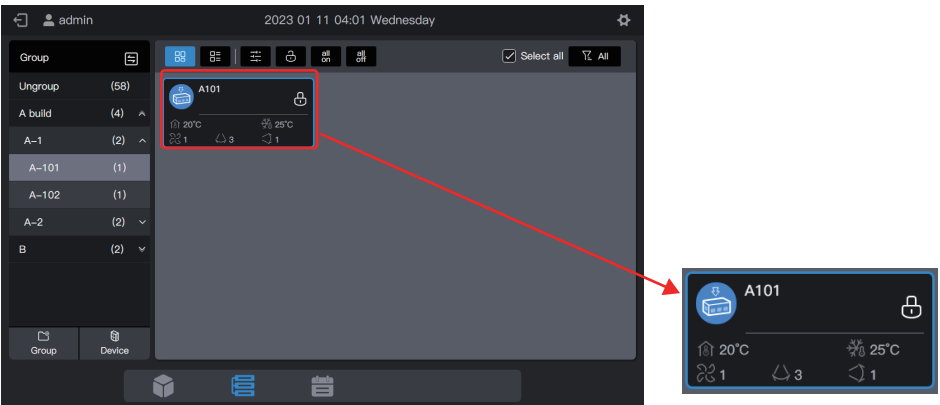

In the list display state, select the IDU by checking the selection box in the first column of the list box.

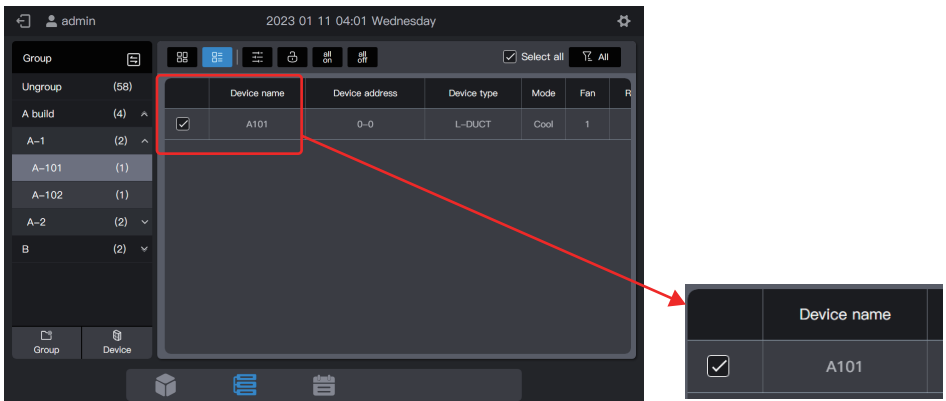

Click "  " to set more parameters of IDUs.

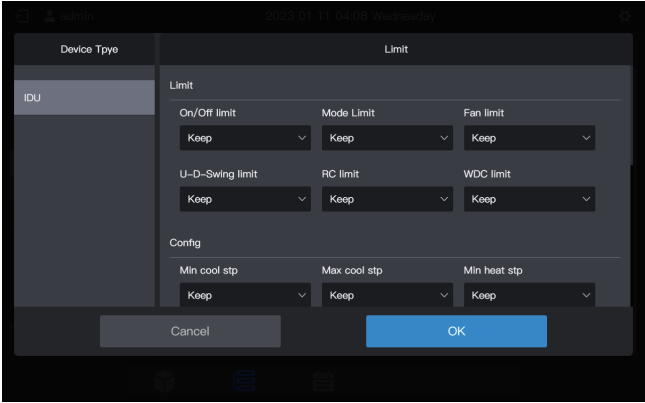

Note: When an extension command is sent, it takes a certain amount of time for the centralized controller to refresh the latest state of IDUs. The specific amount of time depends on the number of connected devices. (According to laboratory test data, when the connected devices are 8 refrigerant systems and 64 IDUs, the maximum polling cycle lasts for about 15 minutes. The actual duration may vary.)

### 2.3.2 System display

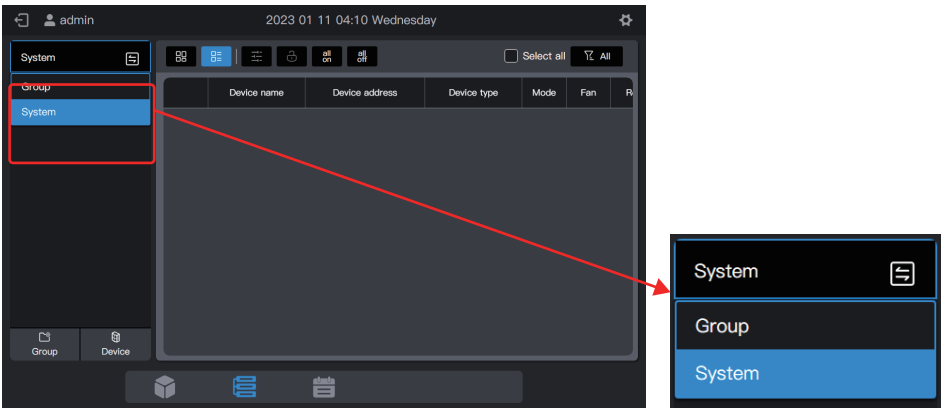







Click  to change the device display mode to "System".

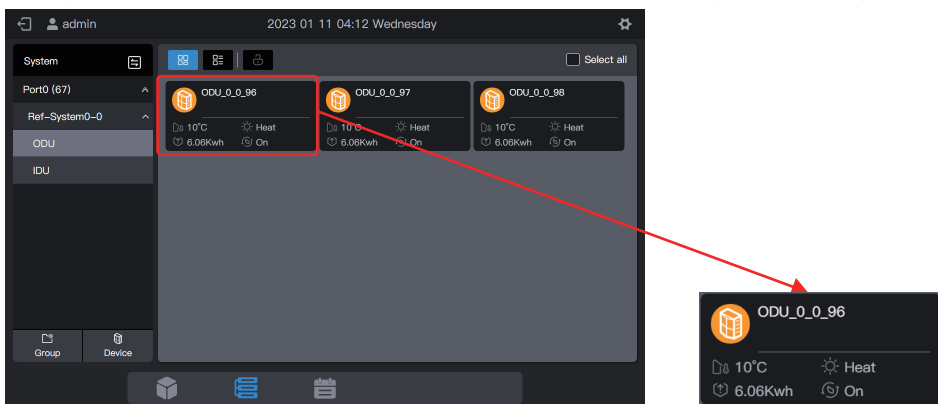

### 2.3.2.1 Card

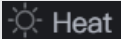
The cards and lists under the "System" display are almost the same as those in group display. The difference lies in the addition of an ODU card in the "System" display.

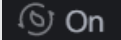

<b>Legends</b>	 10°C	 Heat
<b>Description</b>	Outdoor ambient temperature	ODU operating mode
<b>Legends</b>	 6.06Kwh	 On
<b>Description</b>	Ammeter display	MPC function
<b>Legends</b>		ODU_0_0_96
<b>Description</b>	Background color: ODU operating mode Model icon: ODU type	ODU Name

Note: The above-mentioned card is only for pattern display, and does not represent the actual states of ODU.

IDU cards are the same as those in "Group Display", which will not be described here.



### 2.3.2.2 List

You can view the parameters of ODUs under the "System" display.

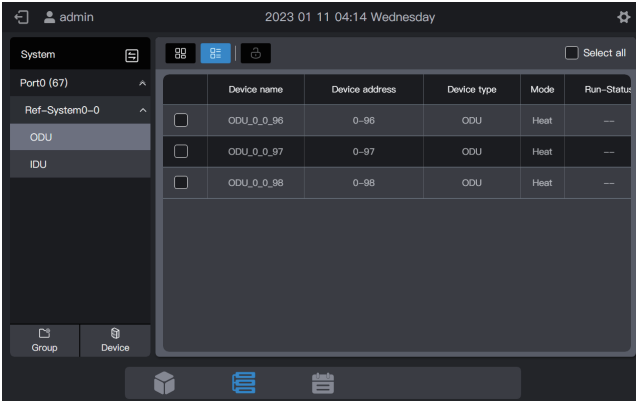

Items in the list of IDUs are the same as those in "Group Display".

	Device name	Device address	Device type	Mode	Fan
<input type="checkbox"/>	A101	0-0	L-DUCT	Cool	1
<input type="checkbox"/>	A102	0-1	WALL	Fan	1
<input type="checkbox"/>	A201	0-2	L-DUCT	Heat	1
<input type="checkbox"/>	A202	0-3	L-DUCT	Auto-Cool	1
<input type="checkbox"/>	B101	0-4	L-DUCT	Auto-Heat	1
<input type="checkbox"/>	B102	0-5	L-DUCT	Cool	1
<input type="checkbox"/>	Change Name	0-6	L-DUCT	Cool	1
<input type="checkbox"/>	IDU_0_0_7	0-7	M-DUCT	Fan	1

### 2.3.2.3 General control

The general control function of IDUs is the same as that in "Group Display". Select the IDU to be controlled.

<b>A101</b> 20°C / 25°C Fan 1	<b>A102</b> 25°C / Off / Off	<b>A201</b> 25°C / 20°C / Off / Off
<b>A202</b> 25°C / 25°C / 25°C / Off / Off	<b>B101</b> 20°C / 20°C / 20°C / Off / Off	<b>B102</b> 20°C / Off / Off / Off
<b>Change Name</b> 25°C / 20°C / Off / Off	<b>IDU_0_0_7</b> 15°C / Off / Off	<b>IDU_0_0_8</b> Device Off
<b>IDU_0_0_9</b> Device Off	<b>IDU_0_0_10</b> Device Off	<b>IDU_0_0_11</b> Device Off

Click "  " to set the operating state of IDUs.

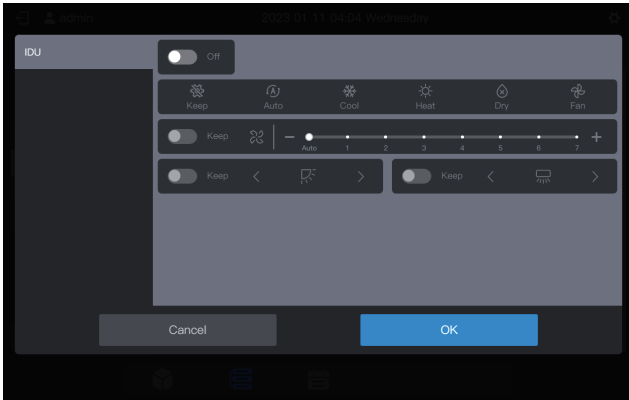

### 2.3.2.4 Extended parameters

The general control function of IDUs is the same as that in "Group Display". Select the IDU to be controlled.

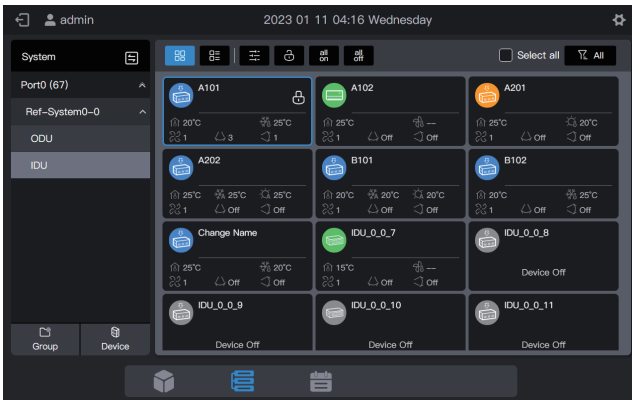

Click "  " to set more parameters of IDUs.

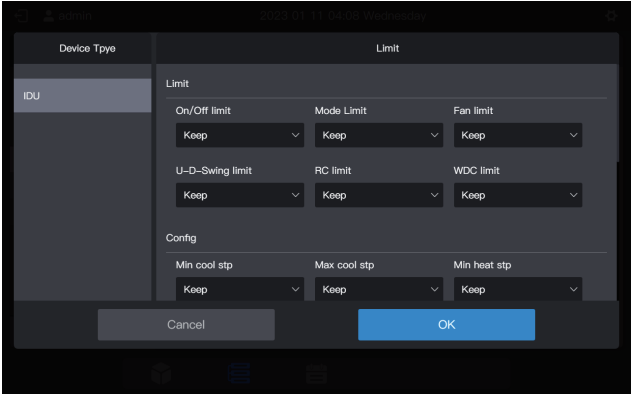

You can set extended parameters for ODUs. Switch to ODUs, and select the ODU to be controlled.

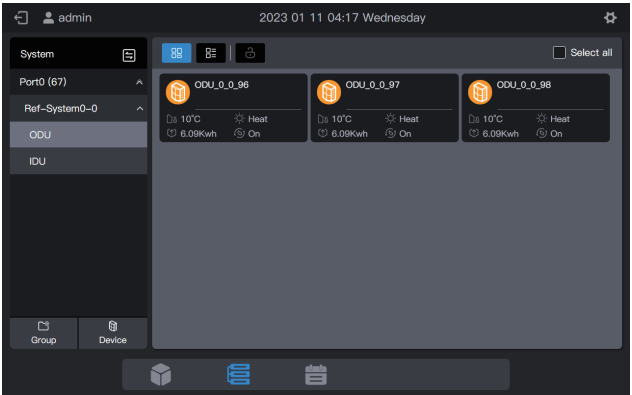

Click "  " to set the parameters of ODU.

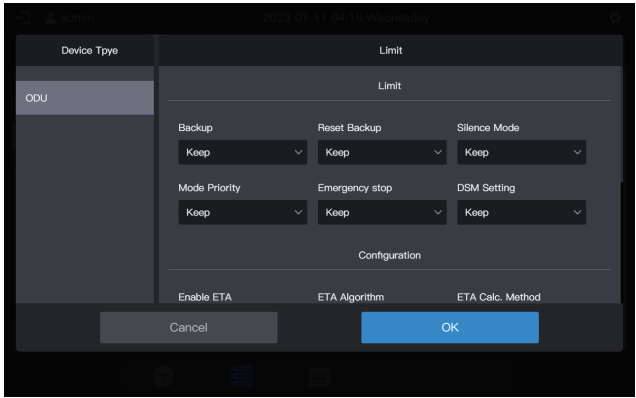

## 2.4 Schedule Management

The schedule function enables IDUs to be powered on and off as planned. The schedule management interface displays the definitions of "Holiday Template" and "Schedule".

Function	Description
Schedule	Set a specific schedule for IDUs to run weekly. The schedule includes 3 elements: 1. Effective date of the schedule; 2. Command daily run by the schedule; 3. IDUs controlled by the schedule.
Holiday template	Referenced in "Schedule", used to implement a special specified date and run a special schedule command.

Refer to the example at the beginning of the manual.

### 2.4.1 Creating a holiday template

A holiday template is a 1-day schedule command template that is referenced in the

### Step 1: Create a holiday template

Click "Holiday template" to enter the template setting interface, and click  to create a "Holiday template".

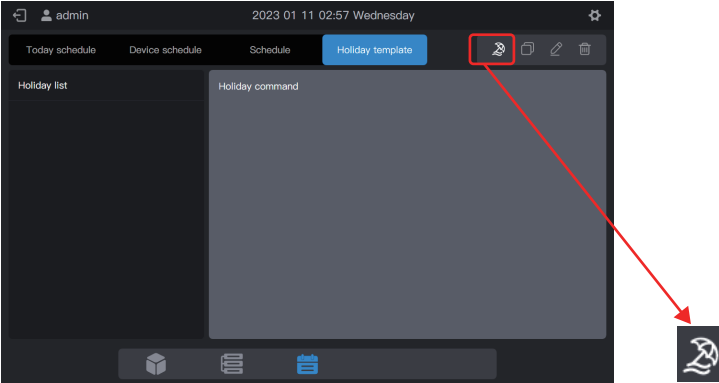

In "Name", enter a name such as "5.1 - 5.3". In "Device type", select according to the actual situation. Here, select "IDU".

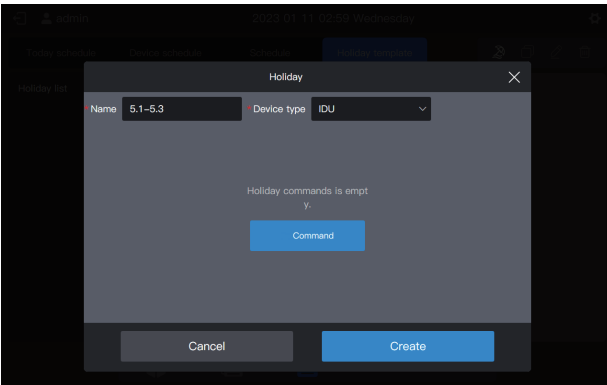

## Step 2: Create a schedule command

Click "Command" to create the execution plan of the template. For example, during the Labor Day holiday, power on the system at 9:30 am. Click "OK" to save the command.

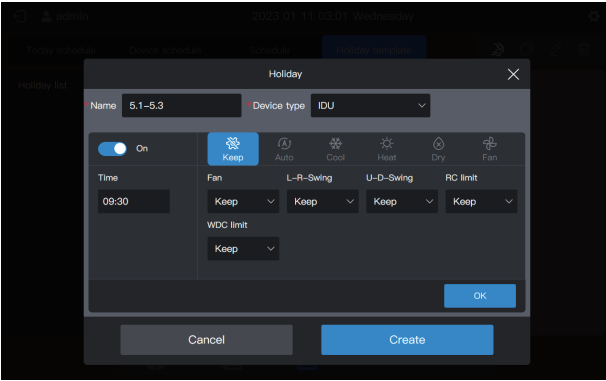

Click "Command" to create a 17:00 power off schedule.

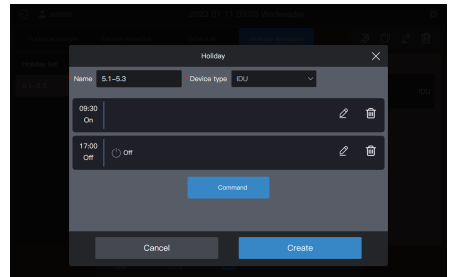
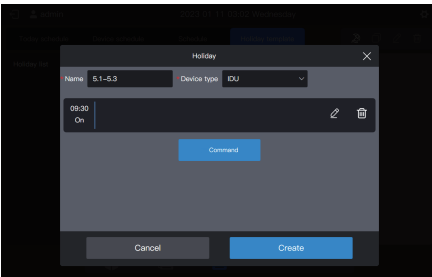



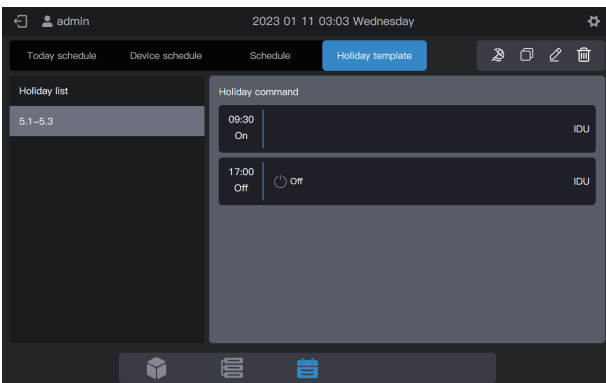

Click "Create", and return to the schedule function interface to see the created holiday template.



Note: As you may have noticed, the system does not determine the date for the execution of the holiday template. The holiday template is created by following the above steps, but it is not used. The template needs to be used in the schedule. The system will specify the date on which the template is executed only if the holiday template is used.

### View, edit, delete or copy the holiday schedule

In the holiday template interface, click the holiday schedule in "Holiday Schedule List" on the left to view the specific schedule template information on the right. Click the function button in the upper right corner to operate the holiday schedule.

Icon				
Function	Create a holiday schedule	Copy the selected holiday schedule	Edit the selected holiday schedule	Delete the selected holiday schedule

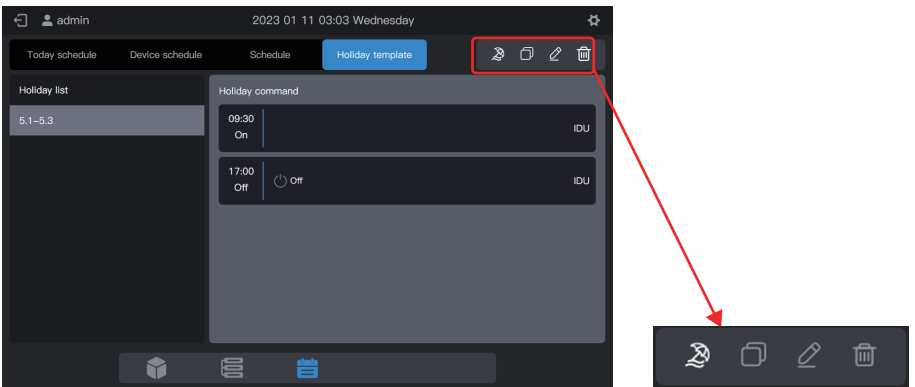

## 2.4.2 Creating a schedule

### Step 1: Create a schedule

Click  to create a "Schedule".

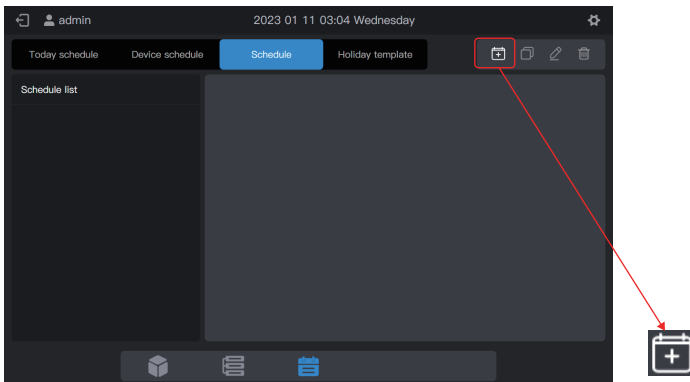

Please complete the basic information of the schedule.

Item	Content	Item	Content
Name	Work Time	Start	2022-01-01
Type	IDU	End	2022-12-31

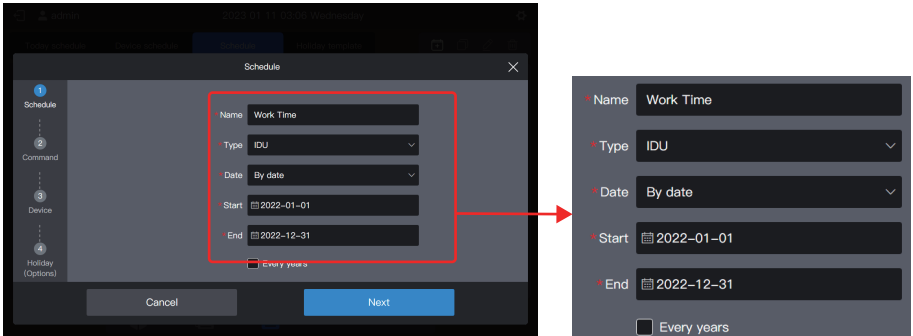

### Step 2: Create a schedule command

Click "Next" to create a schedule command

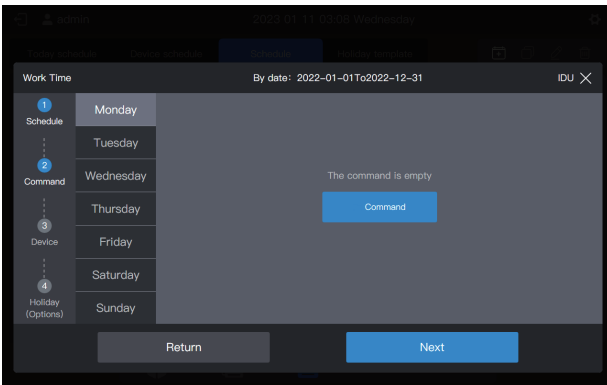

Click "Command" to create the command to be executed. Upon creation of a command, click "OK" to save the command (same as the operation in the holiday template).

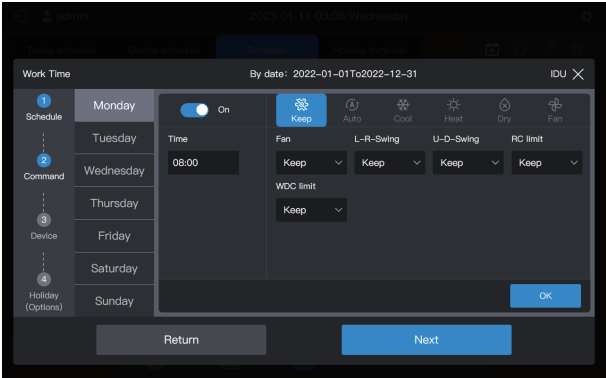

Create two schedule commands: power on at 08:00 and power off at 18:00.

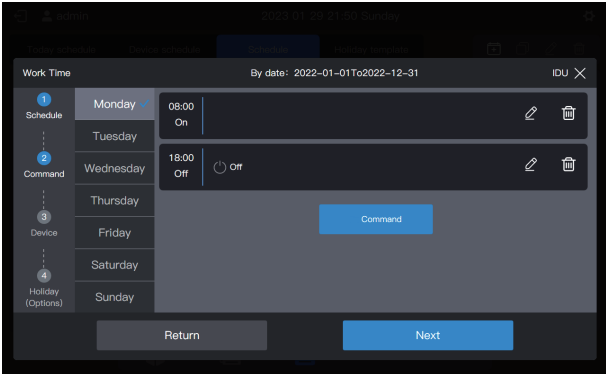

For example, click "Tuesday" to set the schedule for Tuesday.

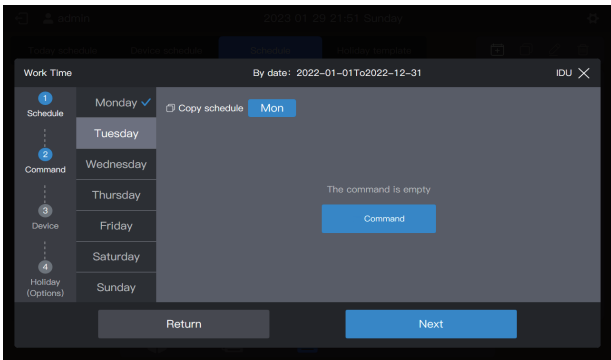

You can create schedule commands by following the steps described above. If the pre-set schedule commands are the same, click "Mon" or any other day after "Copy schedule" to copy the schedule command for the selected day.

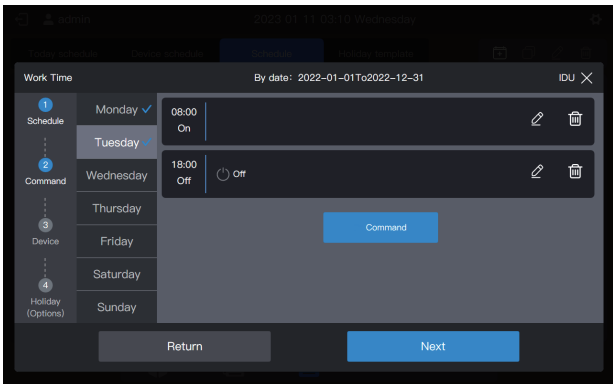

Note: If no schedule command is set for a certain day, the schedule for that day will not be executed. In this example, no schedule command is set for Saturday or Sunday, as shown below:

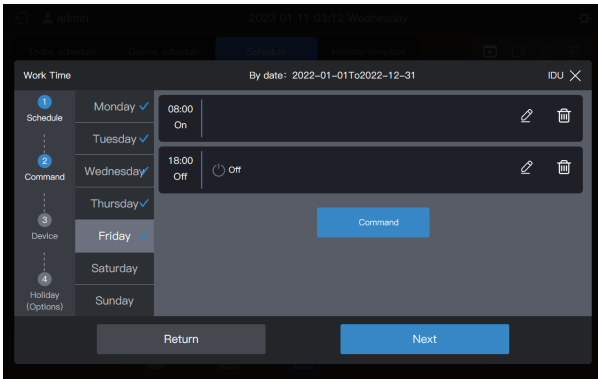

### Step 3: Select the device to execute the schedule

Click "Next", and select the device to execute the schedule. Here, select A101, A102, A201 and A202 IDUs.

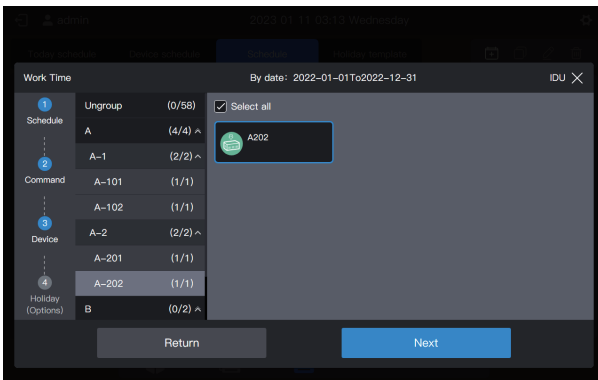

### Step 4: Create a schedule command

Click "Next" to enter the "Holiday" setting interface.

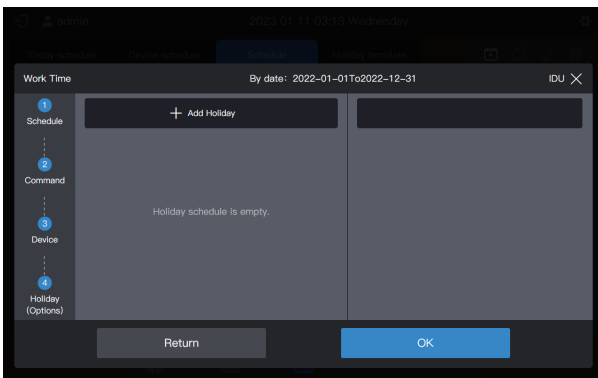

A schedule supports multiple holiday schedule cards. The system executes the schedule commands in the "Holiday Template" on the specified date, instead of the schedule commands in the schedule. As required at the beginning of the example, during the Labor Day holiday, the system should be powered on at 09:00 instead of 08:00 as planned in the schedule and powered off at 17:00 instead of 18:00 as planned in the schedule.

Click "Add holiday". A holiday schedule card will appear on the interface. Set the "Start" date to 2022-05-01 and the "End" date to 2022-05-03. For the "Holiday Template", select "5.1 - 5.3".

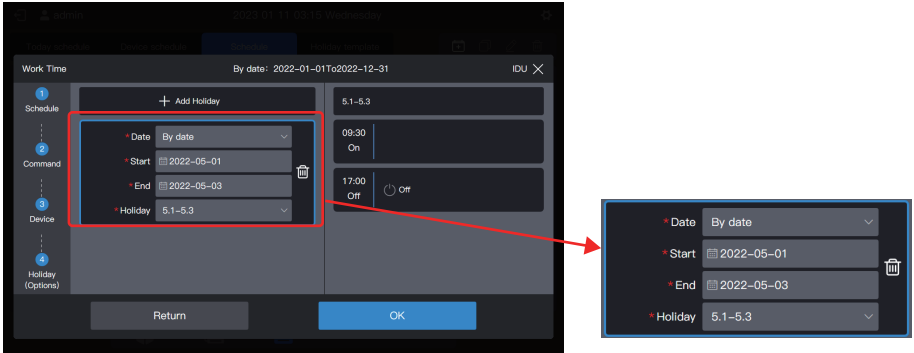

Note: If no "Holiday template" is available, you can save the schedule. After a "holiday template" is created, edit the schedule again and add the corresponding holiday template.

Note: If a "Holiday schedule" card is available and the "Holiday template" is selected as "No template", the schedule will not be executed on the corresponding date.

## View, edit, delete or copy the schedule

In the schedule interface, click the schedule in the left "Schedule list" to view the specific schedule information on the left. Click the function button in the upper right corner to operate the schedule.

Icon				
Function	Create a schedule	Copy the selected schedule	Edit the selected schedule	Delete the selected schedule

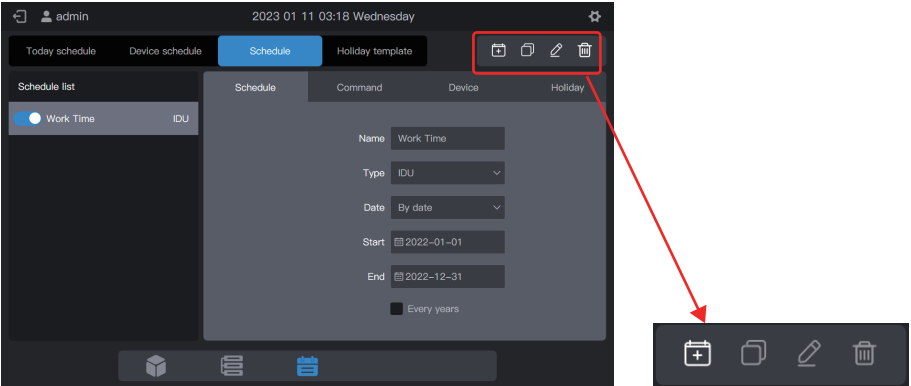

## 2.5 Setting

Click the setting icon in the upper right corner to enter the "Setting" interface, as shown below:

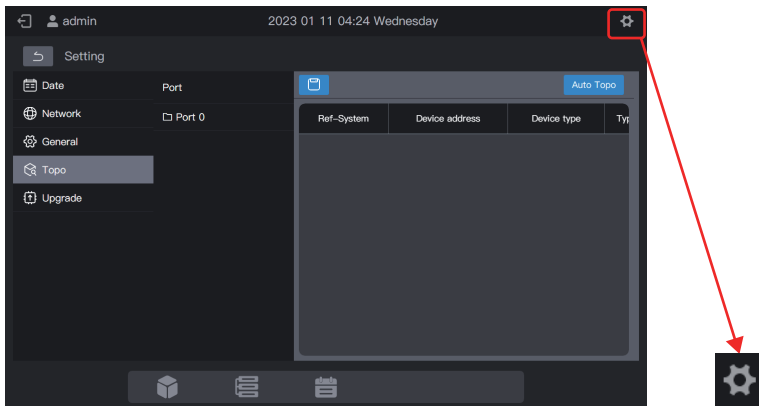

## 2.5.1 Date

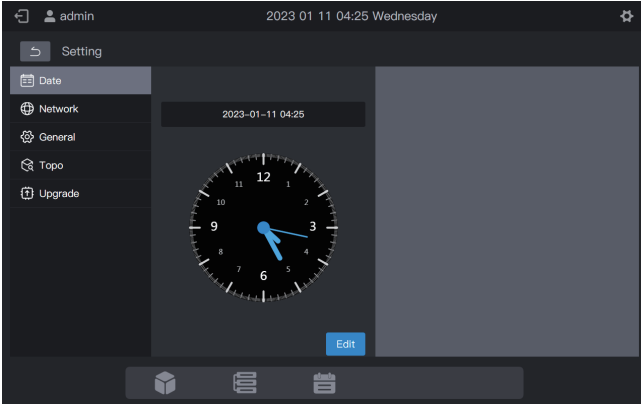

In the "Date Setting" module, you can set the date of the centralized controller. Click "Edit". Then, the centralized controller enters the date setting state. At this time, the clock will stop and not start until the controller exits the date setting state.

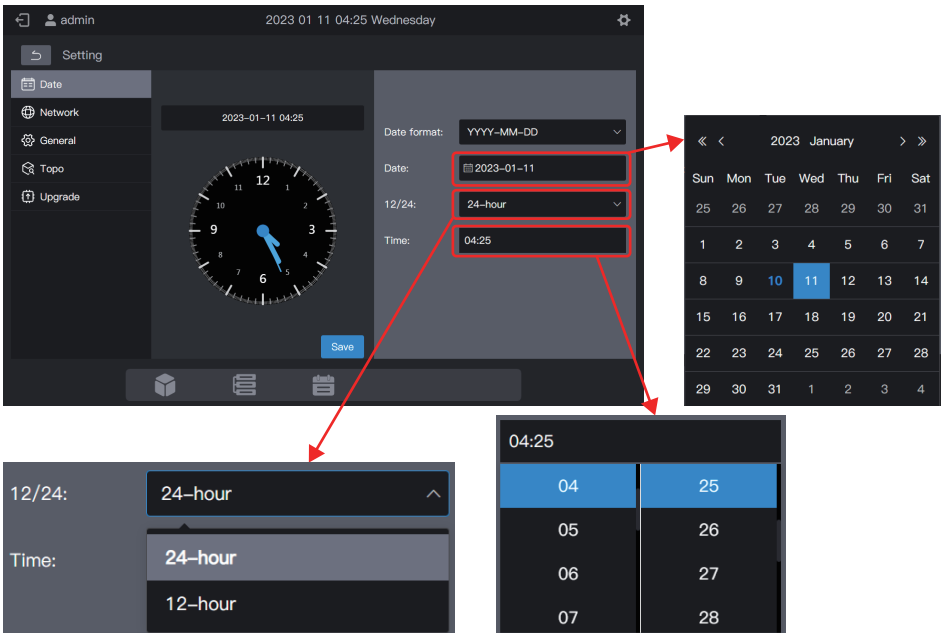

Finally, click "Save" to set the effective date.

## 2.5.2 Network

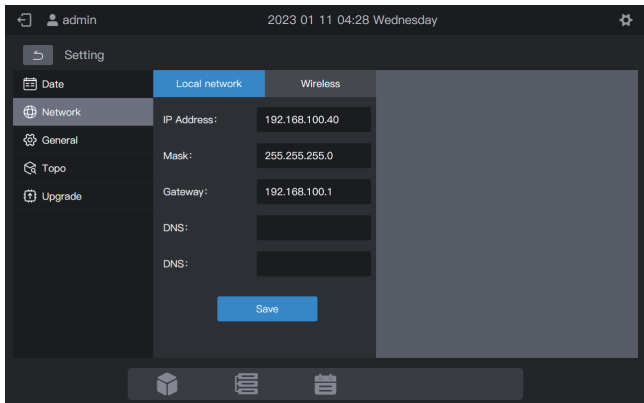

Enter the corresponding IP address and click "Save" to activate the Internet.

Note: If you set the parameters through the WEB page, the current page becomes invalid after the network is modified. You need to log in to the page using a new IP address.

Click "Wireless" to switch to the wireless network configuration page.

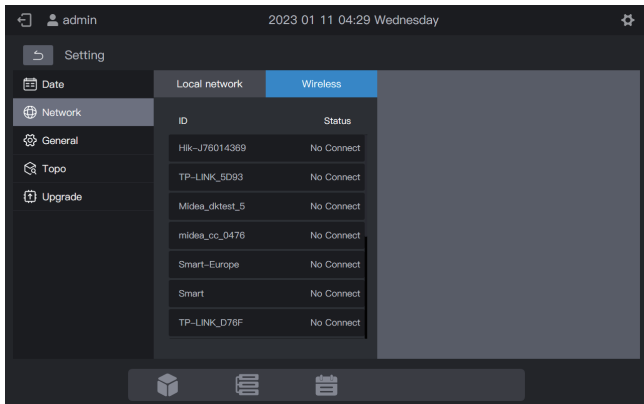

Select the network to be configured, and click "Connect" on the right interface.

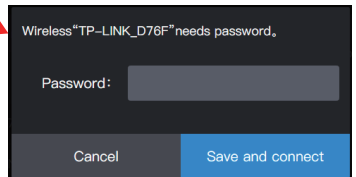
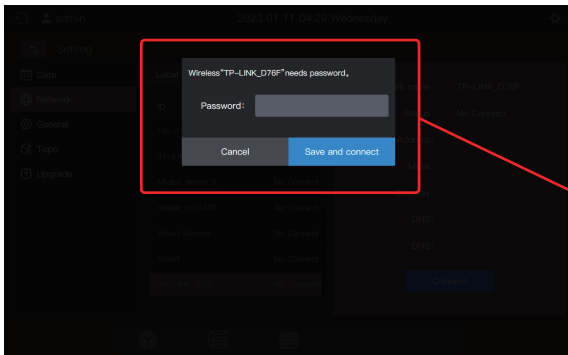
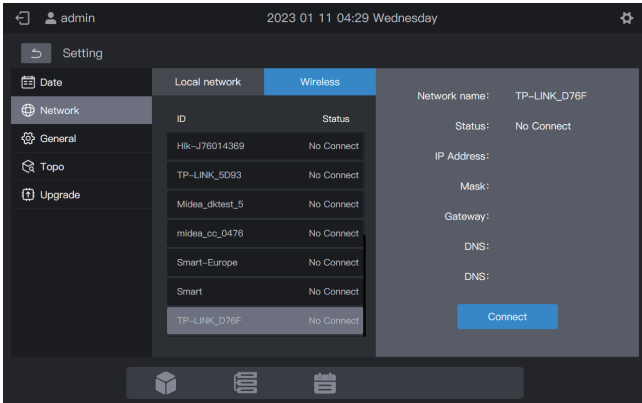

### 2.5.3 General

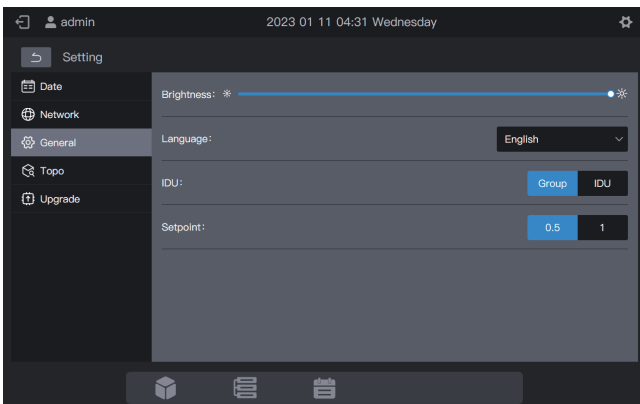

Brightness	Adjust the display brightness of the centralized controller Note: The screen brightness takes effect on the touch screen after you set it on the WEB page.
Language	Set the display language of the centralized controller interface
IDU	Group: Subgroups displayed in the form of cards; IDU: Only IDUs in the group displayed Note: Only the card interface is affected. The list display mode is not affected.
Setpoint	The interval between all set temperature control parameters is 1 or 0.5.

## 2.5.4 Topo

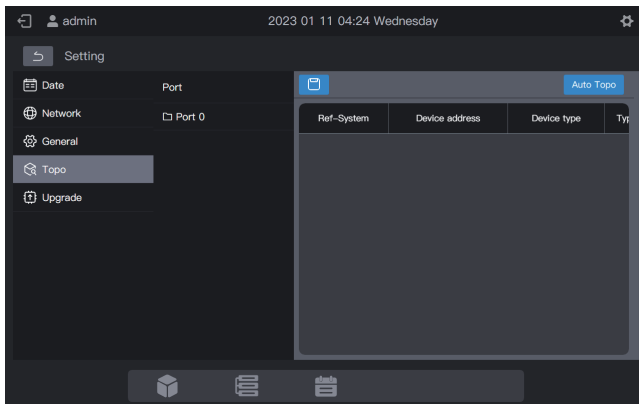

To use the centralized controller for the first time, you need to search for the device connected to it before the controller displays that device.

\* The centralized controller must meet the requirements for the following two periods of time before conducting "Device search"

Time 1: Time taken to wait for the VRF refrigerant system to run properly (about 15 minutes, depending on the actual refrigerant system).  
When the refrigerant system is powered on, system detection will take some time. During this period, the centralized controller may obtain incorrect information about the refrigerant system. If you conduct "Device search" at this moment, the information about the refrigerant system obtained by the centralized controller will be incorrect (model identification failure, improper set temperature range, and insufficient VRF units, etc.).

Time 2: time of communication between the centralized controller and VRFs (depending on the number of connected refrigerant systems, about 5 minutes).  
It takes more than 5 minutes for the centralized controller to connect with the properly running VRF system. If you conduct a "Device search" before this, the information about the refrigerant system obtained by the centralized controller will be abnormal (model identification failure, improper set temperature range, and insufficient VRF units, etc.).

Steps: Power on the centralized controller 15 minutes after the communication cables are connected and the VRF system is powered on. Wait 5 minutes, and search for the device.

Click "Topo" in the left menu and "Auto Topo" in the right area. The centralized controller will start to obtain information about the refrigerant system connected to the centralized controller and automatically construct the topological relationship. After this, the interface will appear as follows:

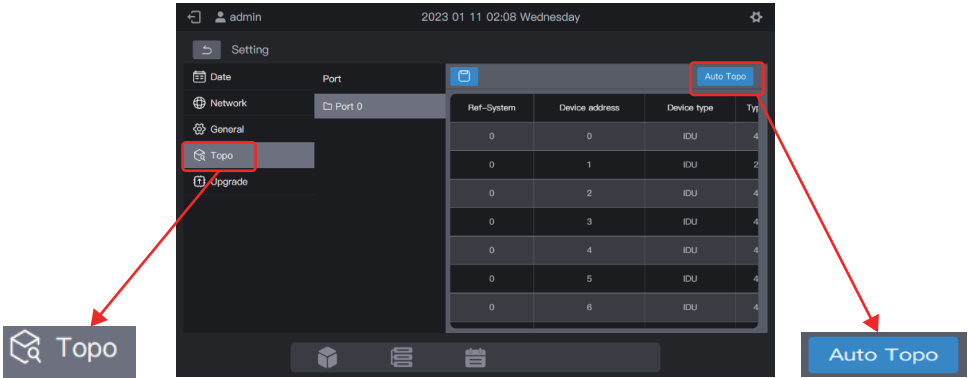

Parameter	Remarks
<b>Ref-System</b>	Refrigerant system address, automatically generated after search, unmodifiable
<b>Device address</b>	Device address, automatically generated after search, unmodifiable IDU: 00 - 63; ODU: 96 - 99 (master unit: 96; slave units 1 - 3: 97 - 99)
<b>Device type</b>	Device type (IDU or ODU), automatically generated after search, unmodifiable
<b>Type</b>	Device model code, automatically generated after search, unmodifiable For details about the mapping between models and codes, see "Model Information" in the appendix.
<b>Device name</b>	Device name in the centralized controller, modifiable The following names are displayed by default: IDU: "IDU_Port_System_IDU Address" ODU: "ODU_Port_System_ODU Address"
<b>Fan(W)</b>	Power of IDU fan, modifiable
<b>EH(W)</b>	Power of IDU auxiliary heater, modifiable

Click the parameters to be modified ("Device name", "Fan (W)", and "EH (W)"), and click  to save the modification.

\* Causes for the failure of the centralized controller to locate the device.

1. Failing to meet the preconditions of the TC3-10.1 centralized controller and the **"Precautions"** at the beginning of this chapter.

Solution: Re-power on the TC3-10.1 centralized controller. After the preconditions are met, search for the device again.

2. In the process of powering on the TC3-10.1 centralized controller, the refrigerant system address and IDU address are modified.

Solution: Re-power on the TC3-10.1 centralized controller. Wait 5 minutes and search for the device again.

For other matters, please consult relevant technical support personnel.

## 2.5.5 Upgrade

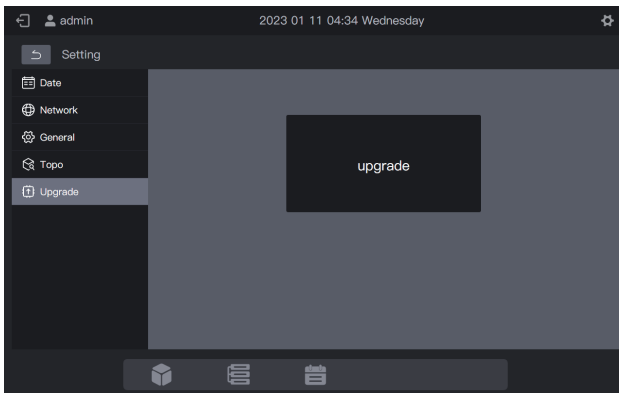

Click "Upgrade" and select the package to be upgraded in the pop-up interface. The centralized controller will automatically restart and upgrade the firmware. This function is only available to professionals.

Note: If a USB flash drive is used for upgrading, the drive should be in FAT format.

Wireless information













Wireless transmit frequency range: 2.400 ~ 2.4835 GHz

EIRP not more than 20dbm

Hereby, GD Midea Heating & Ventilating Equipment Co.,Ltd., declares that this model is in compliance with the essential requirements and other relevant provisions of RE Directive 2014/53/EU. A copy of the full DoC is attached.

# Appendix

## Appendix 1 Model Icons

Model	Icon
4-Way Cassette (4-Way)	
Wall-mounted	
Medium Static Pressure Duct (M-Duct)	
Low Static Pressure Duct (L-Duct)	
Air Handling Unit (AHU)	
High Static Pressure Duct (H-Duct)	
Compact 4-Way Cassette (COMPACT)	
Ceiling & Floor	
Vertical Type Concealed	
1-Way Cassette	
2-Way Cassette	
Fresh Air Processing Unit	
HRV	

16111500001650 V.A

### 印刷技术要求

材质	封面封底为双胶纸120g，内页80g双胶纸
规格	145*210 (双面)
颜色	黑白
其他	/