

Compact four-way cassette VRF Indoor Units with DC Fan Motor

1. Features	2
2. Specifications	3
3. Dimensions	6
4. Service Spaces	7
5. Piping Diagrams (EXV beside)	8
6. Wiring Diagrams	9
7. Capacity Tables	10
8. Electrical Characteristics	15
9. Sound Levels	16
10. Accessories	18

1. Features

(1) Low operation noise, quiet design for user comfort

- Streamline plate ensures quietness
- Creates natural and comfortable environment

(2) Efficient cooling

- Equal, fast and wide—range cooling



(3) The adoption of the most advanced 3-dimensional centrifugal fan

- Reduces the air resistance passing through and operating sound.
- Smooths air flow
- Makes air speed distribution to the heat exchange uniform.

(4) Improvement for easy installation and maintenance

- Little space is required for installation into a shallow ceiling,
- Extremely compact casing (22-7/16in (570mm) **in width and depth**) enables unit to fit flush into ceilings and match standard architectural modules
- Because of the compactness and weight reduction of the main unit and panel, all models can be installed without a hoist.

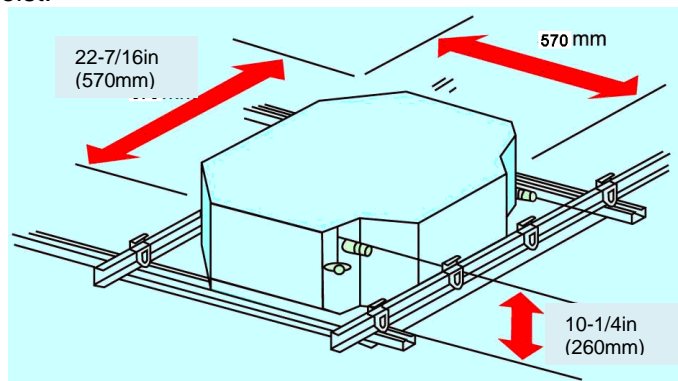

(5) 360° Air Flow Panel

- 360° air outlet makes equal, fast and wide range cooling



(6) Optimal design, smaller Control Box, Space saving and convenient for wiring,

Using fire resistance galvanized steel for E-box material. Metal box makes the control part more stable and prevents damaging

(7) Drain up pump with 19-11/16 in. (500mm) lift fitted as standard, max. up to 23-5/8 in (600mm) head which can be customized.

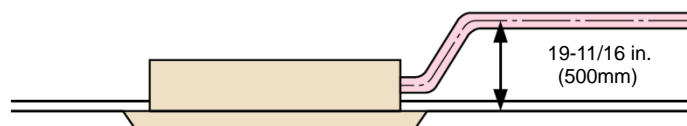

(7) Adopting DC fan motor.

(7.1)Efficiency can be up to 90%. Contrast with the AC fan motor, the power consumption of DC fan motor can reduce up to 30%.

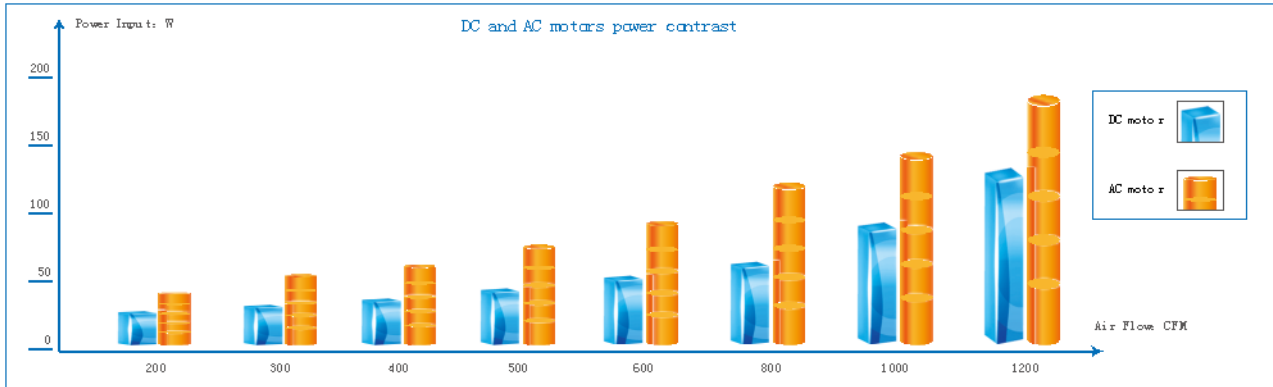

(7.2)The motor adopts fully enclosed structure design. The motor bearing can operate 80,000 hours continuously and easy for maintenance.



(7.3)Thanks to the DC fan motor, this wall-mounted indoor unit can meet the latest CE certification requirements.

2. Specifications

Model		MI-15Q4/DHN1-A3	MI-22Q4/DHN1-A3	MI-28Q4/DHN1-A3	
Power supply		V-ph-Hz	220-240V~1Ph~50/60Hz	220-240V~1Ph~50/60Hz	
Cooling	Capacity	kW	1.5	2.2	
		Btu/h	5100	7500	
	Input	W	14	15	
	Rated current	A	0.23	0.26	
Heating	Capacity	kW	1.7	2.4	
		Btu/h	5800	8200	
	Input	W	11	13	
	Rated current	A	0.23	0.26	
Indoor fan motor	Model		WZDK37-38G	WZDK37-38G	
	Type		DC Motor	DC Motor	
	Input	W	16.4	19.5	
	Speed(H/M/L)	r/min	580/490/400	640/530/440	
Indoor coil	Number of rows		1	1	
	Tube pitch(a)x row pitch(b)	in.(mm)	13/16x17/32(21x13.37)		
	Fin spacing	in.(mm)	1/16(1.5)	1/16(1.5)	
	Fin type (code)		Hydrophilic aluminium		
	Tube outside dia. and type	in.(mm)	1/4(Φ6.35)	1/4(Φ6.35)	1/4(Φ6.35)
			Inner groove tube		Inner groove tube
	Coil length x height x width	in.(mm)	51-9/16x8-9/32x17/32(1310x210x13.37)		
	Number of circuits		2	2	2
Indoor air flow (H/M/L)		m ³ /h	526/449/364	526/449/364	
		CFM	309/264/214	309/264/214	
Sound level (sound pressure)		dB(A)	33/32/21	34/32/22	
Indoor unit	Dimension (Wx HxD)	in.(mm)	22-7/16x10-15/64x22-7/16(570x260x570)		
	Packing (WxHxD)	in.(mm)	26-9/16x11-7/32x26-9/16(675x285x675)		
	Net/Gross weight	lbs. (kg)	35.3/48.5(16/22)		
Panel	Dimension (Wx HxD)	in.(mm)	25-15/32x1-31/32x25-15/32(647x50x647)		
	Packing (Wx HxD)	in.(mm)	28-5/32x4-27/32x28-5/32(715x123x715)		
	Net/Gross weight	lbs. (kg)	6.6/11(3/5)		
Refrigerant	Type	R410a	R410a	R410a	
Throttle		Electrical expansive valve			
Design pressure(H/L)		MPa	4.4/2.6	4.4/2.6	
Refrigerant piping	Liquid side	in.(mm)	1/4(Φ6.35)	1/4(Φ6.35)	
	Gas side	in.(mm)	1/2(Φ12.7)	1/2(Φ12.7)	
Connection wiring	Power wiring	mm ²	3x2.0		
	Signal wiring	mm ²	3x0.5 (3-core shielded wire)		
Drainage water pipe diameter		in.(mm)	OD 63/64 (Φ25)	OD 63/64 (Φ25)	
controller		Wireless remote controller (RM05/BG(T)E-A) (Standard)			

Notes:

- Nominal cooling capacities are based on the following conditions: return air temperature: 80.6°F (27°C)DB,66.2°F (19°C)WB, and outdoor temperature: 95°F (35°C)DB, equivalent ref. piping: 26.25ft(8m) (horizontal)
- Nominal heating capacities are based on the following conditions: return air temperature: 68°F (20°C)DB, outdoor temperature: 44.6°F (7°C)DB,42.8°F (6°C)WB, and equivalent ref. Piping: 26.25ft(8m)(horizontal)

Model		MI-36Q4/DHN1-A3	MI-45Q4/DHN1-A3
Power supply		V-ph-Hz	220-240V~1Ph~50/60Hz
Cooling	Capacity	kW	3.6
		Btu/h	12300
	Input	W	21
	Rated current	A	0.28
Heating	Capacity	kW	4
		Btu/h	13600
	Input	W	18
	Rated current	A	0.28
Indoor fan motor	Model		WZDK37-38G
	Type		DC Motor
	Input	W	23.6
	Speed(H/M/L)	r/min	700/570/450
Indoor coil	Number of rows		2
	Tube pitch(a)x row pitch(b)	in.(mm)	13/16x17/32(21x13.37)
	Fin spacing	in.(mm)	1/16(1.5)
	Fin type (code)		Hydrophilic aluminium
	Tube outside dia. and type	in.(mm)	1/4(Φ6.35)
			Inner groove tube
	Coil length x height x width	in.(mm)	51-9/16x8-9/32x1-1/16(1310x210x26.74)
Number of circuits		4	
Indoor air flow (H/M/L)		m3/h	604/516/400
		CFM	336/304/235
Sound level (sound pressure)		dB(A)	40/34/27
Indoor unit	Dimension (Wx HxD)		22-7/16x10-15/64x22-7/16(570x260x570)
	Packing (WxHxD)		26-9/16x11-7/32x26-9/16(675x285x675)
	Net/Gross weight		38.6/51.8(17.5/23.5)
Panel	Dimension (Wx HxD)		25-15/32x1-31/32x25-15/32(647x50x647)
	Packing (Wx HxD)		28-5/32x4-27/32x28-5/32(715x123x715)
	Net/Gross weight		6.6/11(3/5)
Refrigerant	Type		R410a
Throttle		Electrical expansive valve	
Design pressure(H/L)		MPa	4.4/2.6
Refrigerant piping	Liquid side	in.(mm)	1/4(Φ6.35)
	Gas side	in.(mm)	1/2(Φ12.7)
Connection wiring	Power wiring	mm ²	3x2.0
	Signal wiring	mm ²	3x0.5 (3-core shielded wire)
Drainage water pipe diameter		in.(mm)	OD 63/64 (Φ25)
controller		Wireless remote controller (RM05/BG(T)E-A) (Standard)	

Notes:

- Nominal cooling capacities are based on the following conditions: return air temperature: 80.6°F (27°C)DB,66.2°F (19°C)WB, and outdoor temperature: 95°F (35°C)DB, equivalent ref. piping: 26.25ft(8m) (horizontal)
- Nominal heating capacities are based on the following conditions: return air temperature: 68°F (20°C)DB, outdoor temperature: 44.6°F (7°C)DB,42.8°F (6°C)WB, and equivalent ref. Piping: 26.25ft(8m)(horizontal)

3. Dimensions

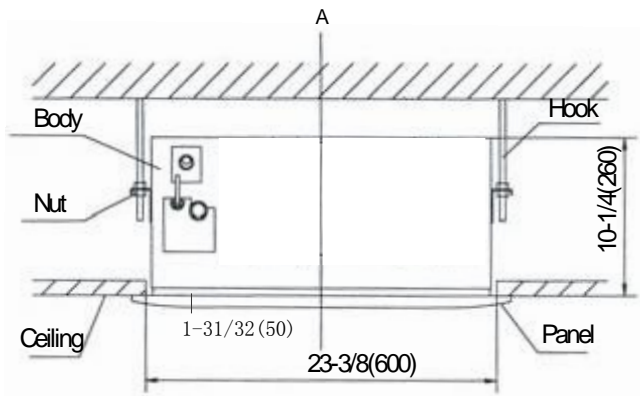
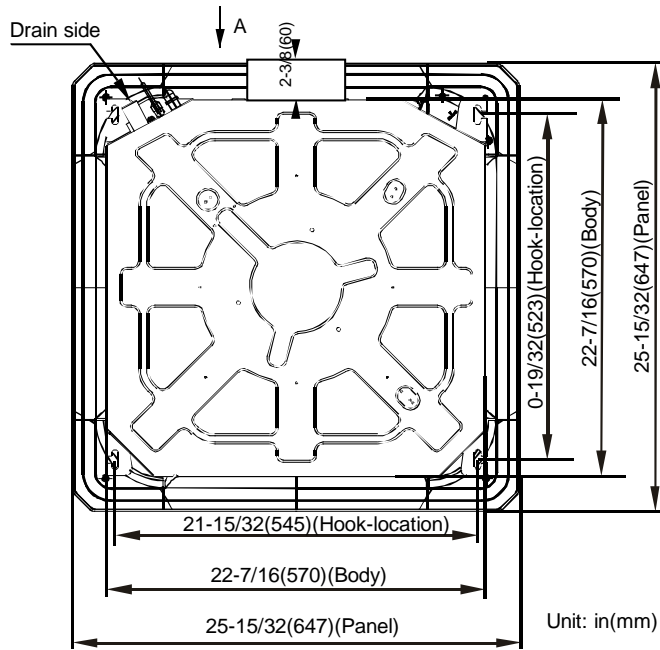

4. Service Spaces

- 1) There is enough room for installation and maintenance.
- 2) The ceiling is horizontal, and its structure can endure the weight of the indoor unit.
- 3) The outlet and the inlet are not impeded, and the influence of external air is the least.
- 4) The air flow can reach throughout the room.
- 5) The connecting pipe and drainpipe could be extracted out easily.
- 6) There is no direct radiation from heaters.

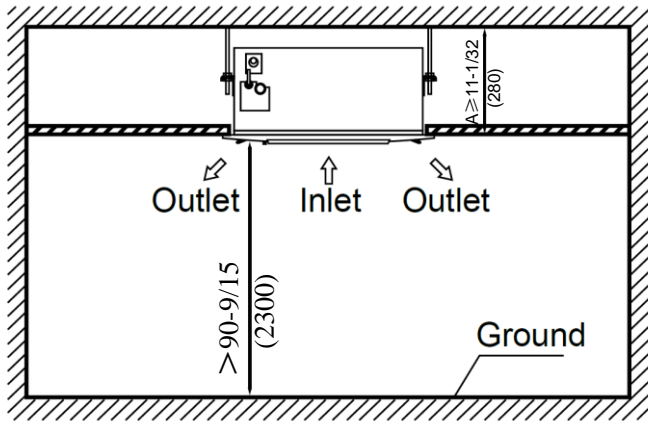

Unit: in(mm)

- Keep more than 7.55ft (2.3m) distance between the panel and ground of the room.

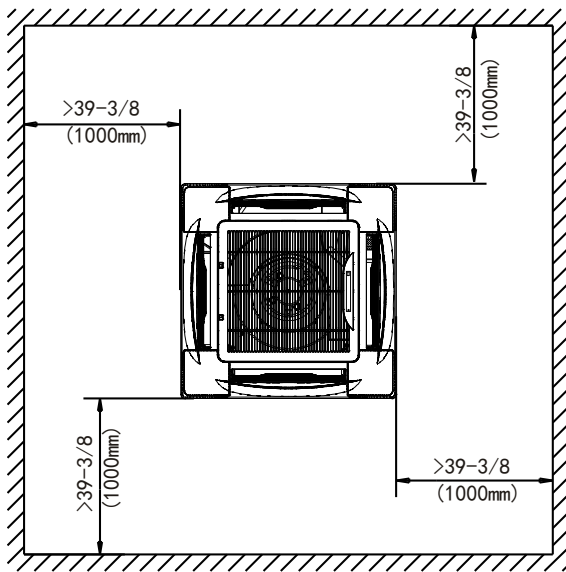

- Keep at least 3.28ft (1m) to the wall of each side.

5. Piping Diagrams (EXV beside)

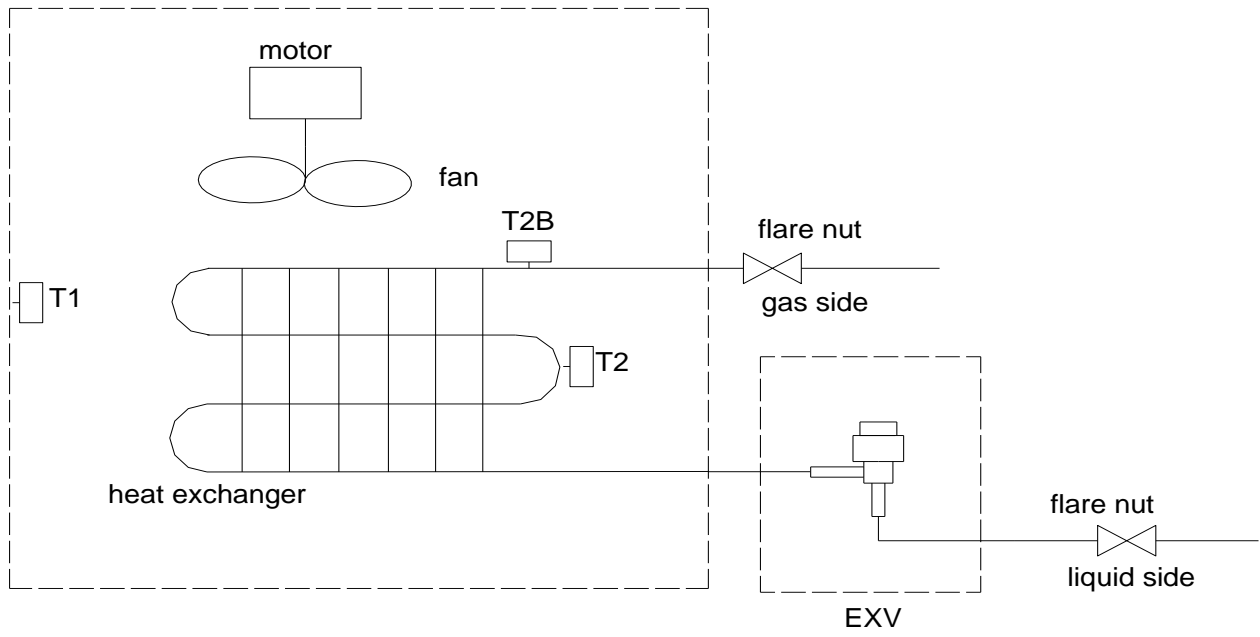

T1: Room temperature;
T2: Temperature of middle evaporator;
T2B: Temperature of evaporator outlet.

6. Wiring Diagrams

MI-15Q4/DHN1-A3 MI-22Q4/DHN1-A3 MI-28Q4/DHN1-A3 MI-36 Q4/DHN1-A3 MI-45Q4/DHN1-A3

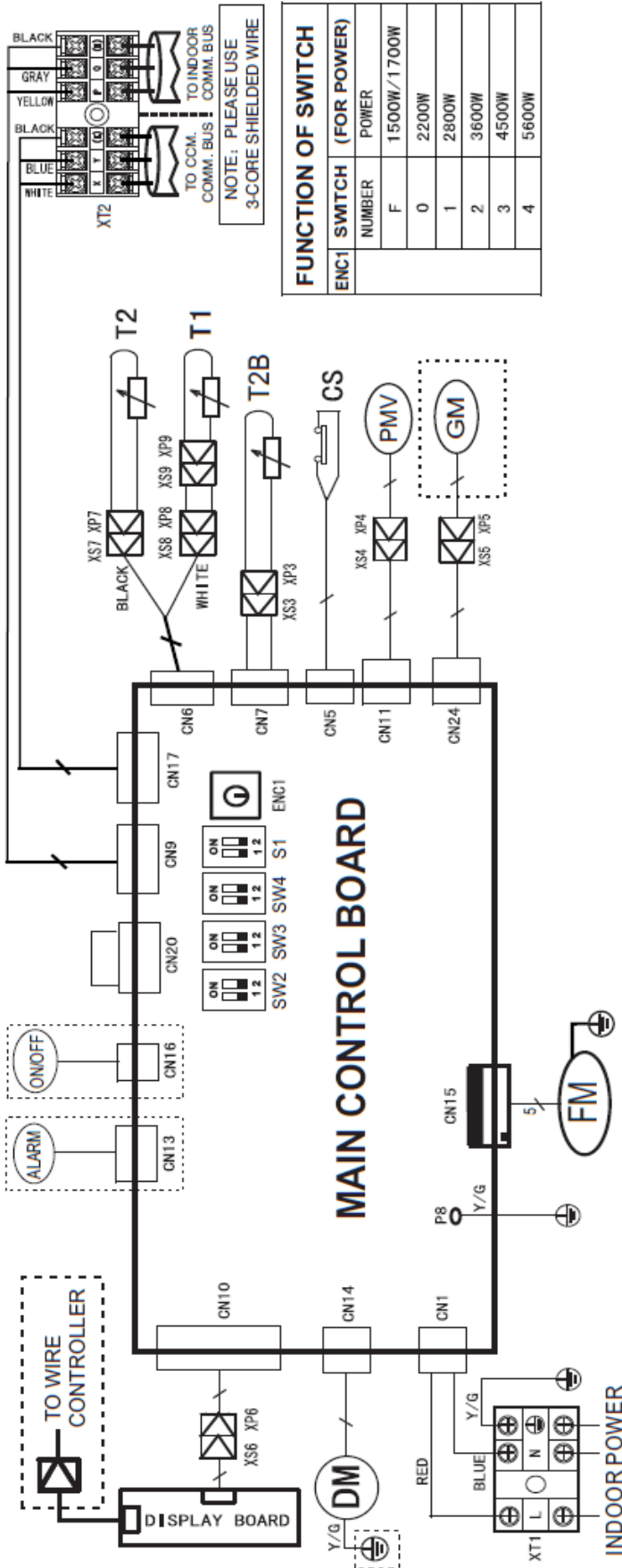

NOTE: PLEASE USE 3-CORE SHIELDED WIRE





FUNCTION OF SWITCH	
ENC1 SWITCH (FOR POWER)	POWER
F	1500W/1700W
0	2200W
1	2800W
2	3600W
3	4500W
4	5600W





CODE	TITLE
FM	INDOOR FAN MOTOR
CS	WATER LEVEL SWITCH
GM	SWING MOTOR
DM	WATER PUMP MOTOR
PMV	PULSE MOTOR EXPANSIVE VALVE
T1	ROOM TEMP. SENSOR
T2B	OUTER PIPE TEMP. SENSOR
T2	MIDDLE PIPE TEMP. SENSOR
XP3-9	CONNECTOR
XS3-9	CONNECTOR
XT1	3-WAY TERMINAL
XT2	6-WAY TERMINAL



Error Code & Indication	
Mode Conflict	Defrost_LED Flash
Communication Error Between Indoor and Outdoor Unit	Time_LED Flash
Temp.sensor Error	Run_LED Flash
Fan Protection	Time_LED Flash Slowly
EEPROM Error	Defrost_LED Flash Slowly
Outdoor Unit Error	Alarm_LED Flash Slowly
Water Level Error	Alarm_LED Flash
No address	Timer_LED and Run_LED flash together





CODE	TITLE
FM	INDOOR FAN MOTOR
CS	WATER LEVEL SWITCH
GM	SWING MOTOR
DM	WATER PUMP MOTOR
PMV	PULSE MOTOR EXPANSIVE VALVE
T1	ROOM TEMP. SENSOR
T2B	OUTER PIPE TEMP. SENSOR
T2	MIDDLE PIPE TEMP. SENSOR
XP3-9	CONNECTOR
XS3-9	CONNECTOR
XT1	3-WAY TERMINAL
XT2	6-WAY TERMINAL

Function setting indication

For Setting anti cold air mode				
SW2				
TYPE	15°C	20°C	24°C	26°C
Factory Setting	✓			

For Setting THERMAL Fan ON/OFF Interval				
SW3				
TYPE	4min	8min	12min	16min
Factory Setting	✓			

For Setting Wind Speed		
S1		
TYPE	Normal	Ultra Low Wind
Factory Setting	✓	

For Heat mode temp. compensation				
SW4				
TYPE	6°C	2°C	4°C	8°C
Factory Setting	✓			

7. Capacity Tables 7.1 Cooling

TC: total capacity SC: sensible capacity WB: wet-bulb temperature DB: dry-bulb temperature

Indoor Unit size (kW)	Outdoor temperature (°F DB)	Indoor temperature (°F WB/DB)													
		57.2/68		60.8/73.4		64.4/78.8		66.2/80.6		68/82.4		71.6/86		75.2/89.6	
		TC	SC	TC	SC	TC	SC	TC	SC	TC	SC	TC	SC	TC	SC
		kW	kW	kW	kW	kW	kW	kW	kW	kW	kW	kW	kW	kW	kW
1.5	50	1.0	0.9	1.2	0.9	1.4	1.0	1.5	1.0	1.6	1.1	1.8	1.1	2.0	1.1
	53.6	1.0	0.9	1.2	0.9	1.4	1.0	1.5	1.0	1.6	1.1	1.8	1.1	1.9	1.0
	57.2	1.0	0.9	1.2	0.9	1.4	1.0	1.5	1.0	1.6	1.1	1.8	1.1	1.9	1.0
	60.8	1.0	0.9	1.2	0.9	1.4	1.0	1.5	1.0	1.6	1.1	1.8	1.1	1.9	1.0
	64.4	1.0	0.9	1.2	0.9	1.4	1.0	1.5	1.0	1.6	1.1	1.8	1.1	1.9	1.0
	68	1.0	0.9	1.2	0.9	1.4	1.0	1.5	1.0	1.6	1.1	1.8	1.1	1.8	1.0
	69.8	1.0	0.9	1.2	0.9	1.4	1.0	1.5	1.0	1.6	1.1	1.8	1.1	1.8	1.0
	73.4	1.0	0.9	1.2	0.9	1.4	1.0	1.5	1.0	1.6	1.1	1.7	1.0	1.8	1.0
	77	1.0	0.9	1.2	0.9	1.4	1.0	1.5	1.0	1.6	1.1	1.7	1.0	1.8	0.9
	80.6	1.0	0.9	1.2	0.9	1.4	1.0	1.5	1.0	1.6	1.1	1.7	1.0	1.8	0.9
	84.2	1.0	0.9	1.2	0.9	1.4	1.0	1.5	1.0	1.6	1.1	1.7	1.0	1.7	0.9
	87.8	1.0	0.9	1.2	0.9	1.4	1.0	1.5	1.0	1.6	1.1	1.7	1.0	1.7	0.9
	91.4	1.0	0.9	1.2	0.9	1.4	1.0	1.5	1.0	1.6	1.1	1.7	1.0	1.7	1.0
	95	1.0	0.9	1.2	0.9	1.4	1.0	1.5	1.0	1.6	1.1	1.6	0.9	1.7	1.0
	98.6	1.0	0.9	1.2	0.9	1.4	1.0	1.5	1.0	1.6	1.1	1.6	0.9	1.6	0.9
	102.2	1.0	0.9	1.2	0.9	1.4	1.0	1.5	1.0	1.5	1.0	1.6	0.9	1.6	0.9
107.6	1.0	0.9	1.2	0.9	1.4	1.0	1.5	1.0	1.5	1.0	1.6	0.9	1.6	0.9	
111.2	1.0	0.9	1.2	0.9	1.4	1.0	1.5	1.0	1.5	1.0	1.6	0.9	1.6	0.9	
114.8	1.0	0.9	1.2	1.0	1.4	1.0	1.5	1.0	1.5	1.0	1.6	0.9	1.6	0.9	
2.2	50	1.5	1.4	1.8	1.5	2.1	1.6	2.2	1.6	2.3	1.7	2.6	1.7	2.9	1.7
	53.6	1.5	1.4	1.8	1.5	2.1	1.6	2.2	1.6	2.3	1.7	2.6	1.7	2.8	1.6
	57.2	1.5	1.4	1.8	1.5	2.1	1.6	2.2	1.6	2.3	1.7	2.6	1.7	2.8	1.6
	60.8	1.5	1.4	1.8	1.5	2.1	1.6	2.2	1.6	2.3	1.7	2.6	1.7	2.8	1.6
	64.4	1.5	1.4	1.8	1.5	2.1	1.6	2.2	1.6	2.3	1.7	2.6	1.7	2.8	1.6
	68	1.5	1.4	1.8	1.5	2.1	1.6	2.2	1.6	2.3	1.7	2.6	1.7	2.7	1.5
	69.8	1.5	1.4	1.8	1.5	2.1	1.6	2.2	1.6	2.3	1.7	2.6	1.7	2.7	1.5
	73.4	1.5	1.4	1.8	1.5	2.1	1.6	2.2	1.6	2.3	1.7	2.5	1.6	2.7	1.5
	77	1.5	1.4	1.8	1.5	2.1	1.6	2.2	1.6	2.3	1.7	2.5	1.6	2.6	1.5
	80.6	1.5	1.4	1.8	1.5	2.1	1.6	2.2	1.6	2.3	1.7	2.5	1.6	2.6	1.5
	84.2	1.5	1.4	1.8	1.5	2.1	1.6	2.2	1.6	2.3	1.7	2.4	1.5	2.5	1.5
	87.8	1.5	1.4	1.8	1.5	2.1	1.6	2.2	1.6	2.3	1.7	2.4	1.5	2.5	1.5
	91.4	1.5	1.4	1.8	1.5	2.1	1.6	2.2	1.6	2.3	1.7	2.4	1.5	2.4	1.5
	95	1.5	1.4	1.8	1.5	2.1	1.6	2.2	1.6	2.3	1.7	2.3	1.5	2.4	1.5
	98.6	1.5	1.4	1.8	1.5	2.1	1.6	2.2	1.6	2.3	1.7	2.3	1.5	2.3	1.5
	102.2	1.5	1.4	1.8	1.5	2.1	1.6	2.2	1.6	2.2	1.6	2.3	1.5	2.3	1.5
107.6	1.5	1.4	1.8	1.5	2.1	1.6	2.2	1.6	2.2	1.6	2.3	1.5	2.3	1.5	
111.2	1.5	1.4	1.8	1.5	2.1	1.6	2.2	1.6	2.2	1.6	2.3	1.5	2.3	1.5	
114.8	1.5	1.4	1.8	1.5	2.1	1.6	2.2	1.6	2.2	1.6	2.3	1.5	2.3	1.5	
2.8	50	1.9	1.6	2.3	1.8	2.6	1.9	2.8	1.9	3.0	1.9	3.3	2.0	3.7	2.0
	53.6	1.9	1.6	2.3	1.8	2.6	1.9	2.8	1.9	3.0	1.9	3.3	2.0	3.6	2.0
	57.2	1.9	1.6	2.3	1.8	2.6	1.9	2.8	1.9	3.0	1.9	3.3	2.0	3.6	2.0
	60.8	1.9	1.6	2.3	1.8	2.6	1.9	2.8	1.9	3.0	1.9	3.3	2.0	3.5	1.9
	64.4	1.9	1.6	2.3	1.8	2.6	1.9	2.8	1.9	3.0	1.9	3.3	2.0	3.5	1.9
	68	1.9	1.6	2.3	1.8	2.6	1.9	2.8	1.9	3.0	1.9	3.3	2.0	3.4	1.9
	69.8	1.9	1.6	2.3	1.8	2.6	1.9	2.8	1.9	3.0	1.9	3.3	2.0	3.4	1.9
	73.4	1.9	1.6	2.3	1.8	2.6	1.9	2.8	1.9	3.0	1.9	3.3	2.0	3.4	1.9
	77	1.9	1.6	2.3	1.8	2.6	1.9	2.8	1.9	3.0	1.9	3.2	1.9	3.3	1.9
	80.6	1.9	1.6	2.3	1.8	2.6	1.9	2.8	1.9	3.0	1.9	3.2	1.9	3.3	1.9
	84.2	1.9	1.6	2.3	1.8	2.6	1.9	2.8	1.9	3.0	1.9	3.1	1.8	3.2	1.8
	87.8	1.9	1.6	2.3	1.8	2.6	1.9	2.8	1.9	3.0	1.9	3.1	1.8	3.2	1.7
	91.4	1.9	1.6	2.3	1.8	2.6	1.9	2.8	1.9	3.0	1.9	3.1	1.8	3.1	1.7
	95	1.9	1.6	2.3	1.8	2.6	1.9	2.8	1.9	2.9	1.9	3.0	1.8	3.1	1.7
	98.6	1.9	1.6	2.3	1.8	2.6	1.9	2.8	1.9	2.9	1.9	3.0	1.8	3.0	1.7
	102.2	1.9	1.6	2.3	1.8	2.6	1.9	2.8	1.9	2.9	1.9	3.0	1.9	3.0	1.7
107.6	1.9	1.6	2.3	1.8	2.6	1.9	2.8	1.9	2.9	1.9	3.0	1.9	3.0	1.7	
111.2	1.9	1.6	2.3	1.8	2.6	1.9	2.8	1.9	2.9	1.9	3.0	1.9	3.0	1.7	
114.8	1.9	1.6	2.3	1.8	2.6	1.9	2.8	1.9	2.9	1.9	3.0	1.9	3.0	1.7	

Indoor Unit size (kW)	Outdoor temperature (°F DB)	Indoor temperature (°F WB/DB)													
		57.2/68		60.8/73.4		64.4/78.8		66.2/80.6		68/82.4		71.6/86		75.2/89.6	
		TC	SC	TC	SC	TC	SC	TC	SC	TC	SC	TC	SC	TC	SC
		kW	kW	kW	kW	kW	kW	kW	kW	kW	kW	kW	kW	kW	kW
	114.8	1.9	1.6	2.3	1.8	2.6	1.9	2.8	1.9	2.9	1.9	3.0	1.9	3.0	1.7
3.6	50	2.5	1.9	2.9	2.1	3.4	2.3	3.6	2.4	3.8	2.5	4.3	2.4	4.7	2.5
	53.6	2.5	1.9	2.9	2.1	3.4	2.3	3.6	2.4	3.8	2.5	4.3	2.4	4.7	2.5
	57.2	2.5	1.9	2.9	2.1	3.4	2.3	3.6	2.4	3.8	2.5	4.3	2.4	4.6	2.4
	60.8	2.5	1.9	2.9	2.1	3.4	2.3	3.6	2.4	3.8	2.5	4.3	2.4	4.5	2.4
	64.4	2.5	1.9	2.9	2.1	3.4	2.3	3.6	2.4	3.8	2.5	4.3	2.4	4.5	2.4
	68	2.5	1.9	2.9	2.1	3.4	2.3	3.6	2.4	3.8	2.5	4.3	2.4	4.4	2.3
	69.8	2.5	1.9	2.9	2.1	3.4	2.3	3.6	2.4	3.8	2.5	4.3	2.4	4.4	2.3
	73.4	2.5	1.9	2.9	2.1	3.4	2.3	3.6	2.4	3.8	2.5	4.1	2.3	4.3	2.2
	77	2.5	1.9	2.9	2.1	3.4	2.3	3.6	2.4	3.8	2.5	4.1	2.3	4.2	2.2
	80.6	2.5	1.9	2.9	2.1	3.4	2.3	3.6	2.4	3.8	2.5	4.0	2.2	4.2	2.2
	84.2	2.5	1.9	2.9	2.1	3.4	2.3	3.6	2.4	3.8	2.5	4.0	2.2	4.1	2.2
	87.8	2.5	1.9	2.9	2.1	3.4	2.3	3.6	2.4	3.8	2.5	4.2	2.6	4.1	2.2
	91.4	2.5	1.9	2.9	2.1	3.4	2.3	3.6	2.4	3.8	2.5	4.2	2.6	3.9	2.1
	95	2.5	1.9	2.9	2.1	3.4	2.3	3.6	2.4	3.8	2.5	4.2	2.6	3.9	2.1
	98.6	2.5	1.9	2.9	2.1	3.4	2.3	3.6	2.4	3.7	2.4	3.8	2.3	3.9	2.1
102.2	2.5	1.9	2.9	2.1	3.4	2.3	3.6	2.4	3.7	2.4	3.8	2.3	3.8	2.1	
107.6	2.5	1.9	2.9	2.1	3.4	2.3	3.6	2.4	3.7	2.4	3.8	2.3	3.8	2.1	
111.2	2.5	1.9	2.9	2.1	3.4	2.3	3.6	2.4	3.7	2.4	3.8	2.3	3.8	2.1	
114.8	2.5	1.9	2.9	2.1	3.4	2.3	3.6	2.4	3.7	2.4	3.8	2.3	3.8	2.1	
4.5	50	3.1	2.4	3.7	2.6	4.2	2.8	4.5	2.9	4.8	3.0	5.3	3.4	5.9	3.0
	53.6	3.1	2.4	3.7	2.6	4.2	2.8	4.5	2.9	4.8	3.0	5.3	3.4	5.9	3.0
	57.2	3.1	2.4	3.7	2.6	4.2	2.8	4.5	2.9	4.8	3.0	5.3	3.4	5.8	3.0
	60.8	3.1	2.4	3.7	2.6	4.2	2.8	4.5	2.9	4.8	3.0	5.3	3.4	5.6	2.9
	64.4	3.1	2.4	3.7	2.6	4.2	2.8	4.5	2.9	4.8	3.0	5.3	3.4	5.7	3.0
	68	3.1	2.4	3.7	2.6	4.2	2.8	4.5	2.9	4.8	3.0	5.3	3.4	5.7	3.0
	69.8	3.1	2.4	3.7	2.6	4.2	2.8	4.5	2.9	4.8	3.0	5.3	3.4	5.6	3.0
	73.4	3.1	2.4	3.7	2.6	4.2	2.8	4.5	2.9	4.8	3.0	5.3	3.4	5.5	3.0
	77	3.1	2.4	3.7	2.6	4.2	2.8	4.5	2.9	4.8	3.0	5.2	3.0	5.4	2.9
	80.6	3.1	2.4	3.7	2.6	4.2	2.8	4.5	2.9	4.8	3.0	5.1	3.0	5.2	2.8
	84.2	3.1	2.4	3.7	2.6	4.2	2.8	4.5	2.9	4.8	3.0	5.1	2.9	5.2	2.8
	87.8	3.1	2.4	3.7	2.6	4.2	2.8	4.5	2.9	4.8	3.0	5.0	2.9	5.1	2.7
	91.4	3.1	2.4	3.7	2.6	4.2	2.8	4.5	2.9	4.8	3.0	4.9	2.8	5.1	2.7
	95	3.1	2.4	3.7	2.6	4.2	2.8	4.5	2.9	4.8	3.0	4.8	2.8	5.0	2.7
	98.6	3.1	2.4	3.7	2.6	4.2	2.8	4.5	2.9	4.8	3.0	4.8	2.9	4.9	2.6
102.2	3.1	2.4	3.7	2.6	4.2	2.8	4.5	2.9	4.6	2.8	4.7	2.8	4.8	2.6	
107.6	3.1	2.4	3.7	2.6	4.2	2.8	4.5	2.9	4.6	2.8	4.7	2.8	4.8	2.6	
111.2	3.1	2.4	3.7	2.6	4.2	2.8	4.5	2.9	4.6	2.8	4.7	2.8	4.8	2.6	
114.8	3.1	2.4	3.7	2.6	4.2	2.8	4.5	2.9	4.6	2.8	4.7	3.1	4.8	2.6	

7.2 Heating

TC: total capacity WB: wet-bulb temperature DB: dry-bulb temperature

Indoor Unit size (kW)	Outdoor temperature (°F)		Indoor temperature (°F DB)					
			60.8	64.4	68	69.8	71.6	75.2
	WB	DB	TC kW	TC kW	TC kW	TC kW	TC kW	TC kW
1.5	-4	-3.64	0.95	0.95	0.95	0.95	0.95	0.95
	-2.2	-1.84	1.02	1.02	1.02	1.02	1.02	1.02
	1.4	1.94	1.07	1.07	1.07	1.07	1.07	1.07
	5	5.54	1.11	1.11	1.11	1.11	1.11	1.11
	8.6	9.32	1.17	1.17	1.17	1.17	1.17	1.17
	12.2	13.1	1.19	1.21	1.21	1.21	1.21	1.21
	14	14.9	1.24	1.24	1.24	1.24	1.24	1.24
	15.62	16.7	1.28	1.28	1.28	1.28	1.28	1.28
	18.32	19.4	1.29	1.29	1.29	1.29	1.29	1.29
	21.92	23	1.34	1.34	1.34	1.34	1.34	1.34
	25.34	26.6	1.41	1.41	1.41	1.41	1.41	1.41
	30.74	32	1.51	1.51	1.51	1.51	1.51	1.43
	35.96	37.4	1.60	1.60	1.60	1.60	1.56	1.43
	39.38	41	1.65	1.65	1.65	1.65	1.56	1.43
	42.8	44.6	1.70	1.70	1.70	1.65	1.56	1.43
46.22	48.2	1.75	1.75	1.70	1.65	1.56	1.43	
49.64	51.8	1.80	1.80	1.70	1.65	1.56	1.43	
53.24	55.4	1.87	1.84	1.70	1.65	1.56	1.43	
56.66	59	1.92	1.84	1.70	1.65	1.56	1.43	
2.2	-4	-3.64	1.34	1.34	1.34	1.34	1.34	1.34
	-2.2	-1.84	1.44	1.44	1.44	1.44	1.44	1.44
	1.4	1.94	1.51	1.51	1.51	1.51	1.51	1.51
	5	5.54	1.56	1.56	1.56	1.56	1.56	1.56
	8.6	9.32	1.66	1.66	1.66	1.66	1.66	1.66
	12.2	13.1	1.68	1.70	1.70	1.70	1.70	1.70
	14	14.9	1.75	1.75	1.75	1.75	1.75	1.75
	15.62	16.7	1.80	1.80	1.80	1.80	1.80	1.80
	18.32	19.4	1.82	1.82	1.82	1.82	1.82	1.82
	21.92	23	1.90	1.90	1.90	1.90	1.90	1.90
	25.34	26.6	1.99	1.99	1.99	1.99	1.99	1.99
	30.74	32	2.14	2.14	2.14	2.14	2.14	2.02
	35.96	37.4	2.26	2.26	2.26	2.26	2.21	2.02
	39.38	41	2.33	2.33	2.33	2.33	2.21	2.02
	42.8	44.6	2.40	2.40	2.40	2.33	2.21	2.02
46.22	48.2	2.47	2.47	2.40	2.33	2.21	2.02	
49.64	51.8	2.54	2.54	2.40	2.33	2.21	2.02	
53.24	55.4	2.64	2.59	2.40	2.33	2.21	2.02	
56.66	59	2.71	2.59	2.40	2.33	2.21	2.02	
2.8	-4	-3.64	1.79	1.79	1.79	1.79	1.79	1.79
	-2.2	-1.84	1.92	1.92	1.92	1.92	1.92	1.92
	1.4	1.94	2.02	2.02	2.02	2.02	2.02	2.02
	5	5.54	2.02	2.02	2.02	2.02	2.02	2.02
	8.6	9.32	2.14	2.14	2.14	2.14	2.14	2.14
	12.2	13.1	2.24	2.24	2.24	2.24	2.24	2.24
	14	14.9	2.34	2.34	2.34	2.34	2.34	2.34
	15.62	16.7	2.40	2.40	2.40	2.40	2.40	2.40
	18.32	19.4	2.43	2.43	2.43	2.43	2.43	2.43
	21.92	23	2.53	2.53	2.53	2.53	2.53	2.53
	25.34	26.6	2.66	2.66	2.66	2.66	2.66	2.66
	30.74	32	2.85	2.85	2.85	2.85	2.85	2.69
	35.96	37.4	3.01	3.01	3.01	3.01	2.94	2.69
	39.38	41	3.10	3.10	3.10	3.10	2.94	2.69
	42.8	44.6	3.20	3.20	3.20	3.10	2.94	2.69
46.22	48.2	3.30	3.30	3.20	3.10	2.94	2.69	
49.64	51.8	3.39	3.39	3.20	3.10	2.94	2.69	
53.24	55.4	3.52	3.46	3.20	3.10	2.94	2.69	
56.66	59	3.62	3.46	3.20	3.10	2.94	2.69	
3.6	-4	-3.64	2.24	2.24	2.24	2.24	2.24	2.24

Indoor Unit size (kW)	Outdoor temperature (°F)		Indoor temperature (°F DB)					
			60.8	64.4	68	69.8	71.6	75.2
			TC	TC	TC	TC	TC	TC
	WB	DB	kW	kW	kW	kW	kW	kW
3.6	56.66	59	3.62	3.46	3.20	3.10	2.94	2.69
	-4	-3.64	2.24	2.24	2.24	2.24	2.24	2.24
	-2.2	-1.84	2.40	2.40	2.40	2.40	2.40	2.40
	1.4	1.94	2.52	2.52	2.52	2.52	2.52	2.52
	5	5.54	2.60	2.60	2.60	2.60	2.60	2.60
	8.6	9.32	2.68	2.68	2.68	2.68	2.68	2.68
	12.2	13.1	2.80	2.80	2.80	2.80	2.80	2.80
	14	14.9	2.92	2.92	2.92	2.92	2.92	2.92
	15.62	16.7	3.00	3.00	3.00	3.00	3.00	3.00
	18.32	19.4	3.04	3.04	3.04	3.04	3.04	3.04
	21.92	23	3.16	3.16	3.16	3.16	3.16	3.16
	25.34	26.6	3.32	3.32	3.32	3.32	3.32	3.32
	30.74	32	3.56	3.56	3.56	3.56	3.56	3.36
	35.96	37.4	3.76	3.76	3.76	3.76	3.68	3.36
	39.38	41	3.88	3.88	3.88	3.88	3.68	3.36
	42.8	44.6	4.00	4.00	4.00	3.88	3.68	3.36
46.22	48.2	4.12	4.12	4.00	3.88	3.68	3.36	
49.64	51.8	4.24	4.24	4.00	3.88	3.68	3.36	
53.24	55.4	4.40	4.32	4.00	3.88	3.68	3.36	
56.66	59	4.52	4.32	4.00	3.88	3.68	3.36	
4.5	-4	-3.64	2.80	2.80	2.80	2.80	2.80	2.80
	-2.2	-1.84	3.00	3.00	3.00	3.00	3.00	3.00
	1.4	1.94	3.15	3.15	3.15	3.15	3.15	3.15
	5	5.54	3.25	3.25	3.25	3.25	3.25	3.25
	8.6	9.32	3.35	3.35	3.35	3.35	3.35	3.35
	12.2	13.1	3.50	3.50	3.50	3.50	3.50	3.50
	14	14.9	3.65	3.65	3.65	3.65	3.65	3.65
	15.62	16.7	3.75	3.75	3.75	3.75	3.75	3.75
	18.32	19.4	3.80	3.80	3.80	3.80	3.80	3.80
	21.92	23	3.95	3.95	3.95	3.95	3.95	3.95
	25.34	26.6	4.15	4.15	4.15	4.15	4.15	4.15
	30.74	32	4.45	4.45	4.45	4.45	4.45	4.20
	35.96	37.4	4.70	4.70	4.70	4.70	4.60	4.20
	39.38	41	4.85	4.85	4.85	4.85	4.60	4.20
	42.8	44.6	5.00	5.00	5.00	4.85	4.60	4.20
	46.22	48.2	5.15	5.15	5.00	4.85	4.60	4.20
49.64	51.8	5.30	5.30	5.00	4.85	4.60	4.20	
53.24	55.4	5.50	5.40	5.00	4.85	4.60	4.20	
56.66	59	5.65	5.40	5.00	4.85	4.60	4.20	

8. Electrical Characteristics

Model	Indoor Unit				Power Supply		IFM	
	Hz	Voltage	Min.	Max.		MFA	kW	FLA
MI-15Q4/DHN1-A3	50/60	220-240	198	254	0.25	15	0.037	0.2
MI-22Q4/DHN1-A3	50/60	220-240	198	254	0.28	15	0.037	0.22
MI-28Q4/DHN1-A3	50/60	220-240	198	254	0.28	15	0.037	0.22
MI-36Q4/DHN1-A3	50/60	220-240	198	254	0.33	15	0.037	0.26
MI-45Q4/DHN1-A3	50/60	220-240	198	254	0.33	15	0.037	0.26

Remark:

MCA: Min. Current Amps. (A)

MFA: Max. Fuse Amps. (A)

kW: Fan Motor Rated Output (kW)

FLA: Full Load Amps. (A)

IFM: Indoor Fan Motor

9. Sound Levels

9.1 Test condition

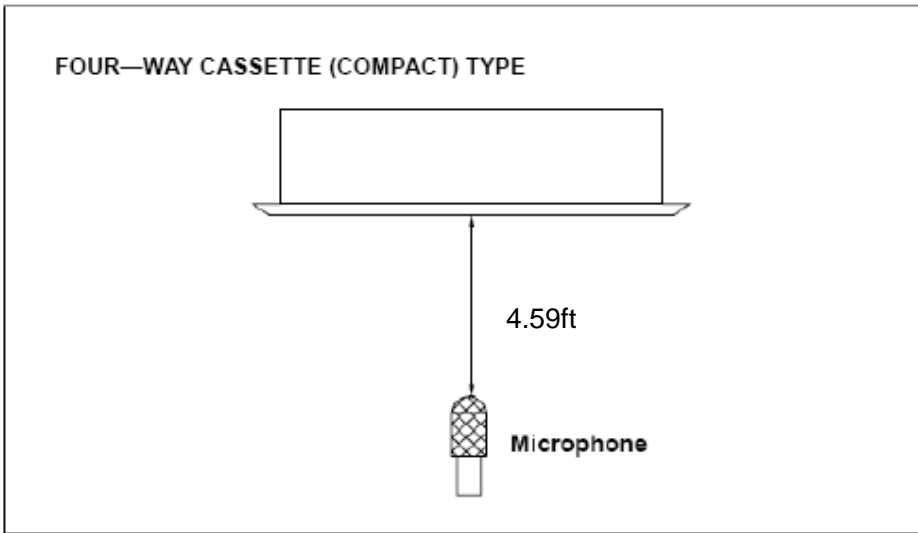

Note:

- 1, During actual operation, these values are normally somewhat higher as a result of ambient conditions.
- 2, Semi-anechoic chamber conversion value, measured at a point which is 4.59ft(1.4m) under the unit.

9.2 Test value

Model	Sound level dB(A)		
	H	M	L
MI-15Q4/DHN1-A3	33	32	21
MI-22Q4/DHN1-A3	34	32	22
MI-28Q4/DHN1-A3	34	32	22
MI-36Q4/DHN1-A3	40	34	27
MI-45Q4/DHN1-A3	40	34	27



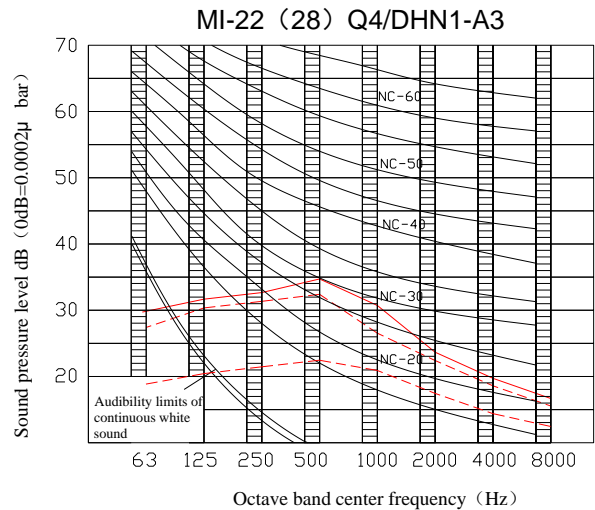
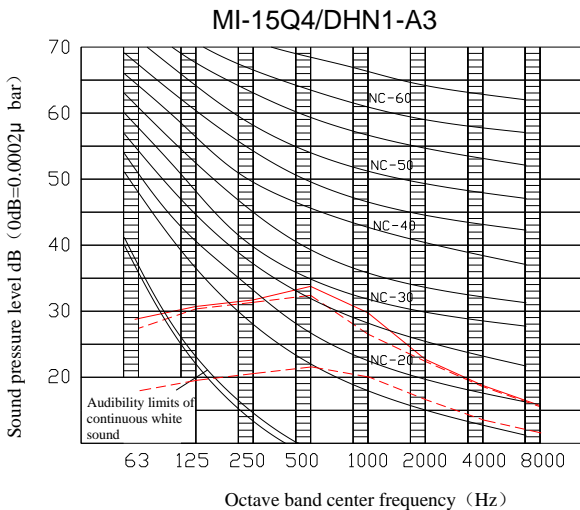



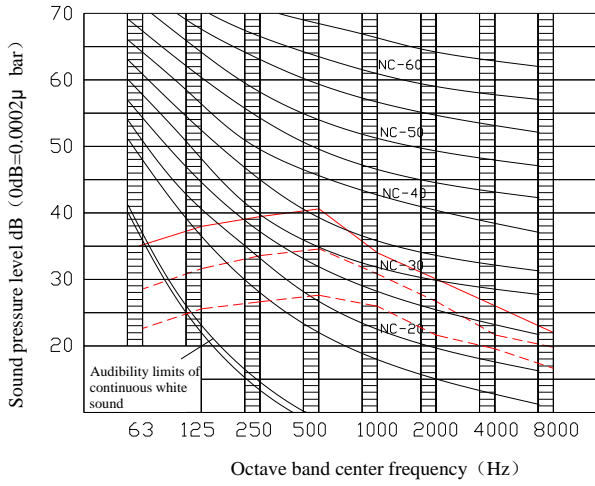

9.3 Octave Band Level

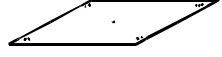
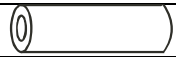

MI-36 (45) Q4/DHN1-A3

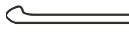

10. Accessories

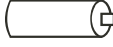
Name	Quantity	Outline
1.Nut M10	10	
2.WasherΦ10	10	
3. Installation paper board	1	
4. Bolt M6	/	/
5. Soundproof / insulation sheath	1	
6. Flexible hose tube	1	
7. Out-let pipe sheath	/	/
8. Drain pipe clasp	1	
9. Tightening band	5	
10. Remote controller	1	
11. Frame	1	
12. Mounting screw(ST2.9×10-C-H)	2	
13. Alkaline dry batteries (AM4)	2	
14. Installation manual	1	/
15. Signal line	1	/
16. Connective pipe for restriction assembly	1	/