



INDICATIVE PRODUCT IMAGE

1.497,47 €

Product file

Code	RCMRKB2350406ED
Refrigerant	R452A
Application	MBP
Series	RCMRKB
Net weight	43 kg
Ped	0
Type	VENTILATED
Typology	Cubic

Evaporator

Fan-motors no.	2
Fan blade diameter	350 mm
Fan-motor type	EC external rotor
Fan-motor voltage	200-240/1/50-60
Max velocity	1600 rpm
Min velocity	850 rpm
Air throw (high velocity)	14 m
Air throw (low velocity)	11 m
Evaporator air flow (high velocity)	3791 m ³ /h
Evaporator air flow (low velocity)	2254 m ³ /h

Evaporator geometry

Geometry	37.5 X 32.475
Tube	TUBE 12
Rows	4
Finned pack length	1050 mm
Fine spacing	6.00 mm
Total surface	16.80 m ²
Circuit volume	5.26 dm ³

Absorptions

Power absorption (high velocity)	230 W
Power absorption (low velocity)	78 W
Current absorption (high velocity)	1.72 A
Current absorption (low velocity)	0.64 A
Number of heaters	4
Heaters voltage	400/3/50-60
Defrost	2800 W

Pipe fittings

Inlet connection	12 mm-1/2" sae
Outlet connection	28 mm
Discharge connection	1" Gas (33mm)

Refrigeration capacity table – RCMRKB2350406ED – Refrigerant: R452A

Cell temperature	ΔT	Capacity	Speed	Limitations
-20 °C	5 K	3894 W	High speed	Application outside the recommended range
-20 °C	6 K	4620 W	High speed	Application outside the recommended range
-20 °C	7 K	5324 W	High speed	Application outside the recommended range
-20 °C	8 K	6039 W	High speed	Application outside the recommended range
-20 °C	9 K	6699 W	High speed	Application outside the recommended range
-20 °C	10 K	7381 W	High speed	Application outside the recommended range
-15 °C	5 K	4048 W	High speed	-
-15 °C	6 K	4796 W	High speed	-
-15 °C	7 K	5544 W	High speed	-
-15 °C	8 K	6281 W	High speed	-
-15 °C	9 K	6996 W	High speed	-
-15 °C	10 K	7689 W	High speed	-
-10 °C	5 K	4246 W	High speed	-
-10 °C	6 K	5016 W	High speed	-
-10 °C	7 K	5786 W	High speed	-
-10 °C	8 K	6556 W	High speed	-
-10 °C	9 K	7304 W	High speed	-
-10 °C	10 K	8030 W	High speed	-
-5 °C	5 K	4499 W	High speed	-
-5 °C	6 K	5291 W	High speed	-
-5 °C	7 K	6072 W	High speed	-
-5 °C	8 K	6876 W	High speed	-
-5 °C	9 K	7656 W	High speed	-
-5 °C	10 K	8416 W	High speed	-
0 °C	5 K	4840 W	High speed	-
0 °C	6 K	5654 W	High speed	-
0 °C	7 K	6446 W	High speed	-
0 °C	8 K	7271 W	High speed	-
0 °C	9 K	8086 W	High speed	-
0 °C	10 K	8866 W	High speed	-
2 °C	5 K	4873 W	High speed	-
2 °C	6 K	5687 W	High speed	-
2 °C	7 K	6490 W	High speed	-
2 °C	8 K	7337 W	High speed	-
2 °C	9 K	8162 W	High speed	-
2 °C	10 K	8966 W	High speed	-
4 °C	5 K	4939 W	High speed	-
4 °C	6 K	5753 W	High speed	-
4 °C	7 K	6534 W	High speed	-
4 °C	8 K	7392 W	High speed	-
4 °C	9 K	8228 W	High speed	-
4 °C	10 K	9053 W	High speed	-
6 °C	5 K	5071 W	High speed	-
6 °C	6 K	5830 W	High speed	-
6 °C	7 K	6622 W	High speed	-
6 °C	8 K	7491 W	High speed	-
6 °C	9 K	8327 W	High speed	-
6 °C	10 K	9130 W	High speed	-
8 °C	5 K	5214 W	High speed	-

Cell temperature	ΔT	Capacity	Speed	Limitations
8 °C	6 K	5996 W	High speed	-
8 °C	7 K	6766 W	High speed	-
8 °C	8 K	7579 W	High speed	-
8 °C	9 K	8426 W	High speed	-
8 °C	10 K	9284 W	High speed	-
10 °C	5 K	5368 W	High speed	-
10 °C	6 K	6149 W	High speed	-
10 °C	7 K	6919 W	High speed	-
10 °C	8 K	7777 W	High speed	-
10 °C	9 K	8602 W	High speed	-
10 °C	10 K	9372 W	High speed	-
12 °C	5 K	5533 W	High speed	-
12 °C	6 K	6314 W	High speed	-
12 °C	7 K	7073 W	High speed	-
12 °C	8 K	7942 W	High speed	-
12 °C	9 K	8778 W	High speed	-
12 °C	10 K	9592 W	High speed	-
15 °C	5 K	5780 W	High speed	-
15 °C	6 K	6561 W	High speed	-
15 °C	7 K	7304 W	High speed	-
15 °C	8 K	8189 W	High speed	-
15 °C	9 K	9042 W	High speed	-
15 °C	10 K	9922 W	High speed	-

For refrigerants with high glide, the DeltaT at mid-point cannot be too low: there is a risk that the refrigerant outlet temperature, taking into account the necessary superheating, will be too close to the air inlet temperature; If this were to occur, the exchanger could not function.

Technical drawings – RCMRKB2350406ED

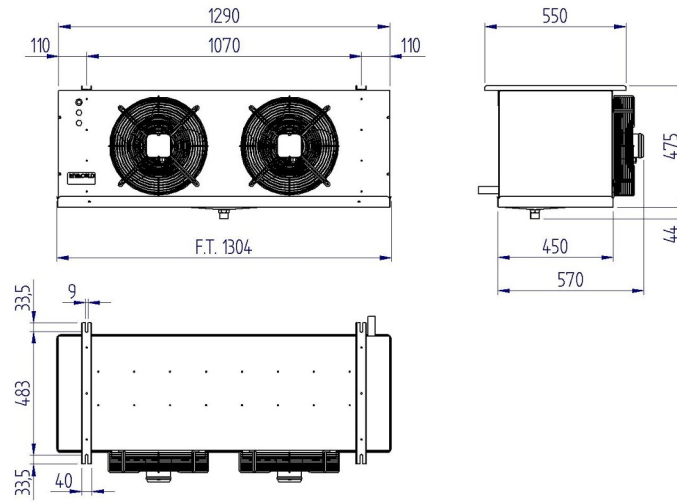



INDICATIVE PRODUCT IMAGE

• GENERAL FEATURES

- RCMR ø350 range unit coolers have been designed to be installed inside cold rooms suited for fresh and frozen goods storage
- This range completes the RC and RCS range applications and though having extremely compact dimensions, reaches bigger capacities suited for medium size cold rooms
- RCMR ø350 range is available in different combinations of fin spacing dimensions and tube rows properly sized according to the needed applications
- The RCMRKB range is supplied as standard with EC fan motors (Identified by the letter "B") and blade with special profile for combining higher efficiency and low absorption.
- Thermostat: system to be connected to the external contactor, to suspend the power supply to the defrosting heaters in the event of malfunction.
- The ED version is supplied with mounted defrosting heaters and is suitable for being used at low temperature applications
- The fan motors operate in the suction mode and prevent the condensate forming on the fan
- The coil is made of aluminium fins, 12 mm copper tube and a geometry of 37,5 x 32,5
- RCMR ø350 unit coolers can be classified in three groups according to the needed cold room temperature (Tc): 4mm fin spacing for a Tc from -5°C to +15°C; 6mm fin spacing for a Tc from -20°C to +15°C; 8mm fin spacing for a Tc from -40°C to +4°C.
- The coils are tested with nitrogen at a pressure of 25 bar.
- The fan motor models in use have the following features:
 - Manufactured following EN 60335-1 laws, with internal thermal protection
 - Fan diameter 350 mm, external rotor
 - Power supply 230-240V/1/50-60Hz
 - IP44 protection rate
 - F insulation class
 - operating temperature -40°C a +65°C
 - Electrics made in conformity with 2006/95/CE Low Tension directive
- The housing is made of aluminium
- The manufacturing solutions used give the housing strength and guarantee the absence of vibrations during the functioning.
- Screws, washers and nuts are made of stainless steel