



# CHINT NR2 Termisko releju sērijas Datu lapa

## Standarti

IEC/EN 60947-4-1

Sertifikāti: CE, EAC, UL, RCC, UkrSEPRO

## Funkcija

Trīsfāžu bimetāla termiskais relejs ar pārslodzes un fāzes zuduma aizsardzību, piemērots kontaktoru sērijām NC1, NC6, NC7 un NC2.

## Elektriskie parametri

Parametrs	Vērtība
Nominālā frekvence	50/60 Hz
Nominālais darba spriegums	līdz 690 V AC
Strāvas diapazons	0.1 A – 150 A (atkarībā no modeļa)
Izslēgšanās klase	10A
Aizsardzības tips	Pārslodzes un fāzes zuduma aizsardzība
Reset režīms	Manuāls un automātisks
Temperatūras kompensācija	Precīza darbība pie apkārtējās temperatūras svārstībām
Testa un stop poga	Iebūvēta
Tripping indikators	Vizuāls signāls
Palīgkontakti	1 NO + 1 NC, elektriski izolēti
Kontaktu nominālie rādītāji	AC-15: 2.73 A (220 V) / 1.58 A (380 V); DC-13: 0.2 A (220 V)
Elektriskā kalpošanas ilgums	≥ 100,000 darbības
Mehāniskā kalpošanas ilgums	≥ 1,000,000 darbības

*Šis tulkojums sniegts kā palīgmateriāls. Par oficiālu un precīzu informāciju jāuzskata tikai ražotāja oriģinālais dokuments.*

## Mehāniskie parametri

Uzstādīšanas veids: Plug-in vai neatkarīga montāža (ar MB piederumiem)

Svars: atkarīgs no modeļa

## Vides parametri

Darba temperatūra: -5 °C ... +40 °C

Uzglabāšanas temperatūra: -25 °C ... +70 °C

Augstums: ≤ 2000 m

Relatīvais mitrums: ≤ 95% RH (bez kondensāta)

Aizsardzības pakāpe: IP20 (ja ievietots korpusā)

## Montāža

Savietojams ar kontaktoru sērijām NC1, NC6, NC7 un NC2.

## Papildaprīkojums

MB piederumi neatkarīgai montāžai.



## NR2 Series Thermal Overload Relays

### 1.General

- 1.1 Certificates: CE, UkrSEPRO, EAC, RCC, UL;
- 1.2 Electric ratings: AC 50/60Hz, 690V, 0.1A~150A;
- 1.3 Tripping class: 10A;
- 1.4 Mounting version: Plug-in;
- 1.5 Standard: IEC/EN 60947-4-1
- 1.6 Overload protection and phase loss protection

### 2.Type designation

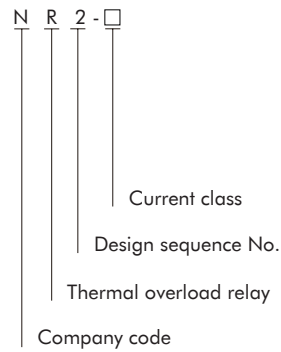

### 3. Features

- 3.1 3-phase bimetal
- 3.2 Continuously readjustable current settings
- 3.3 Temperature compensation
- 3.4 Tripping indicator
- 3.5 Test button
- 3.6 Stop button
- 3.7 Manual and automatic reset button
- 3.8 Electrically separated 1N/O plus 1N/C contact
- 3.9 For direct mounting on contactor or independent mounting

### 4. Technical data

#### 4.1 Protection properties

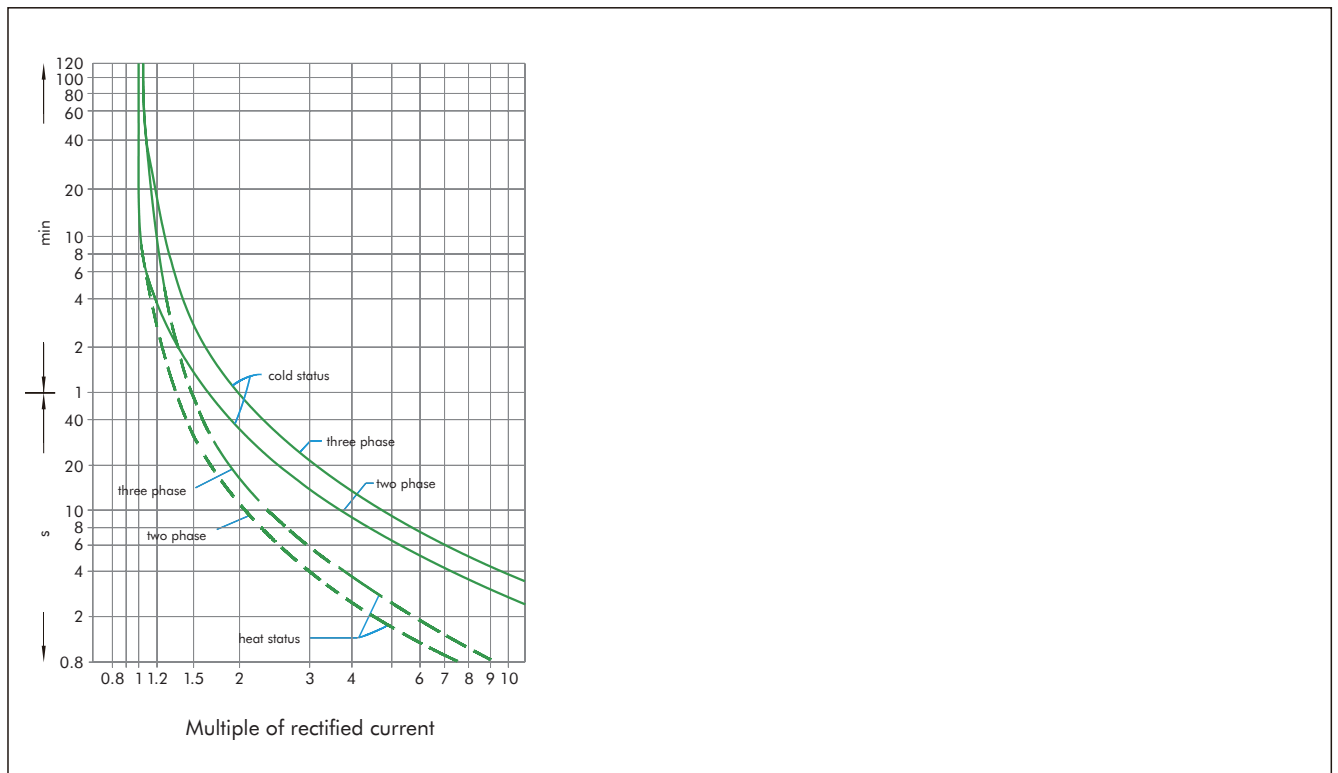

Item	Series No.	Multiples of current Setting		Tripping time	Test condition
Overload protection	1	1.05		>2h	Start from cold state
	2	1.2		≤2h	Start from heat state, right after item No.1
	3	1.5		≤2min	Start from heat state, right after item No.1
	4	7.2		2s < T <sub>p</sub> ≤ 10s	Start from cold state
Phase failure protection	5	Any two phases	Another phase	>2h	Start from cold state
		1.0	0.9		
	6	1.15	0	≤2h	Start from heat state, right after item No.5

#### Curves



Model		NR2-11.5
Picture		
Current class(A)		13
Phase loss protection function		Yes
Automatic & manual reset		Yes
Temperature compensation		Yes
Tripping indicator		Yes
Test & stop pushbutton		Yes
Mounting mode	Plug-in	Yes
	Independent	Yes
Auxiliary contacts	No. of contacts	1N/O+1N/C
	Rated current (A) (AC-15 220V)	2.73
	Rated current (A) (AC-15 380V)	1.58
	Rated current (A) (DC-13 220V)	0.2

Model		NR2-93
Picture		
Current class(A)		93
Phase failure protection function		Yes
Automatic & manual reset		Yes
Temperature compensation		Yes
Tripping indicator		Yes
Test & stop pushbutton		Yes
Mounting mode	Plug-in	Yes
	Independent	Yes
Auxiliary contacts	Configuration of contactsRated	1N/O+1N/C
	Rated current (A) (AC-15 220V)	2.73
	Rated current (A) (AC-15 380V)	1.58
	Rated current (A) (DC-13 220V)	0.2

NR2-25	NR2-36
	
25	36
Yes	Yes
Yes	Yes
Yes	Yes
Yes	Yes
Yes	Yes
Yes	Yes
Yes	Yes
Yes	Yes
Yes	Yes
1N/O+1N/C	1N/O+1N/C
2.73	2.73
1.58	1.58
0.2	0.2

NR2-150

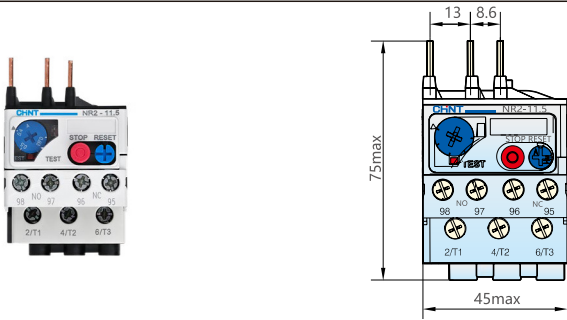
150
Yes
Yes
Yes
Yes
Yes
Yes
No
1N/O+1N/C
2.73
1.58
0.2

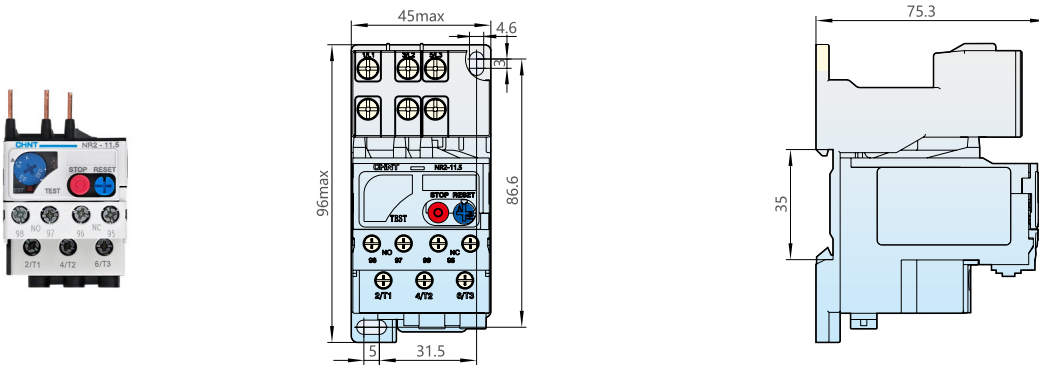

NR2-11.5 with MB-1

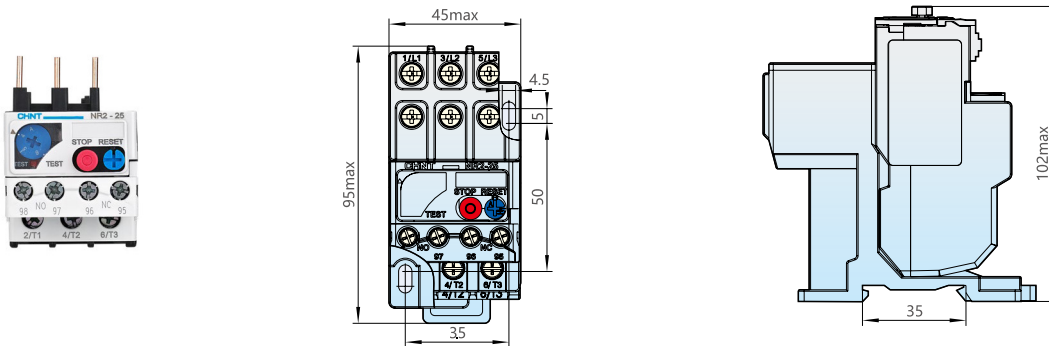

NR2-25



NR2-25 with MB-2

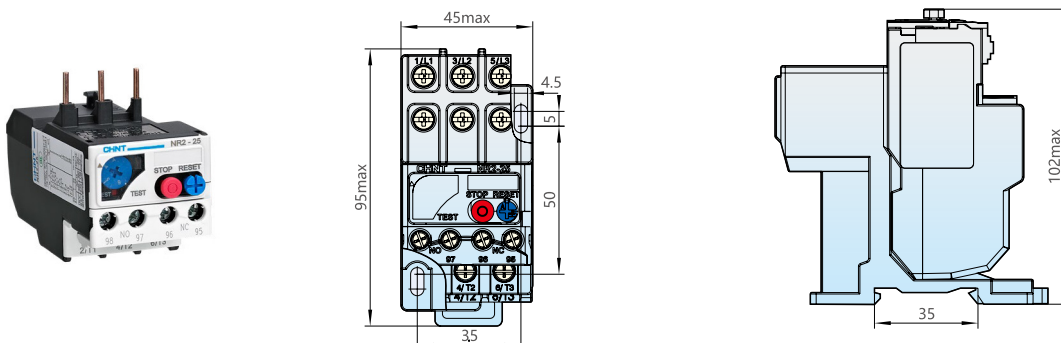

NR2-36

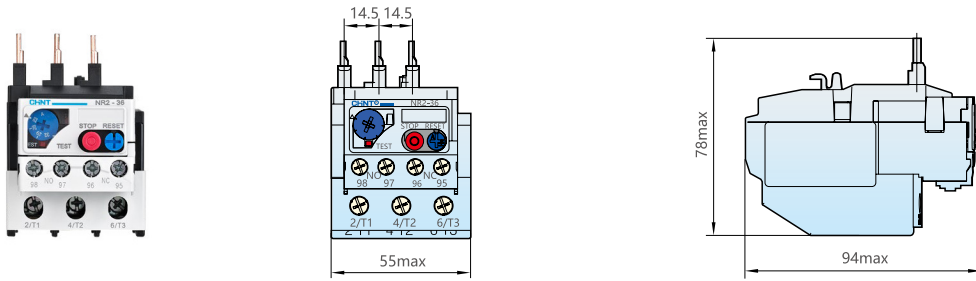

NR2-36 with MB-3

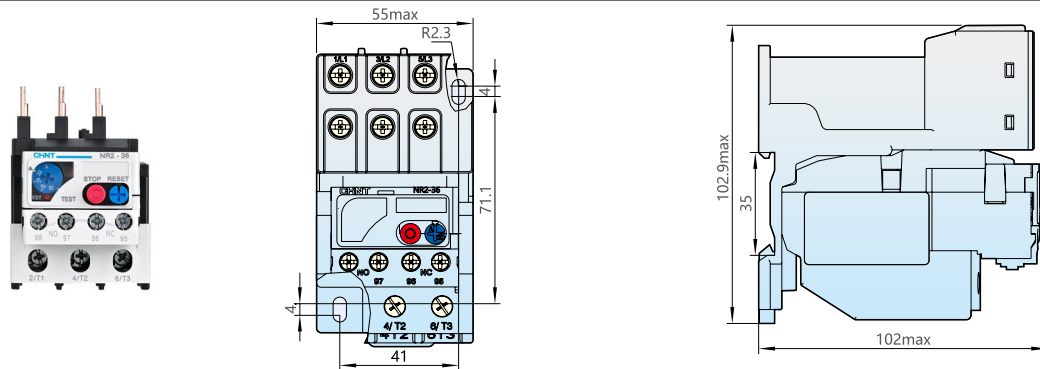

NR2-93

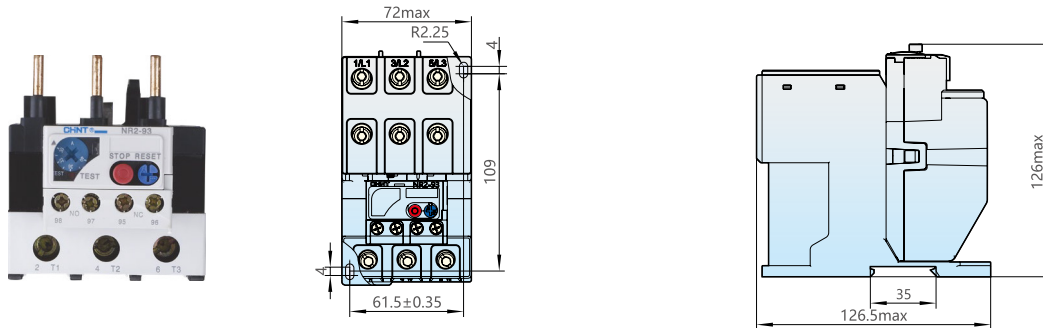

NR2-93 with MB-4

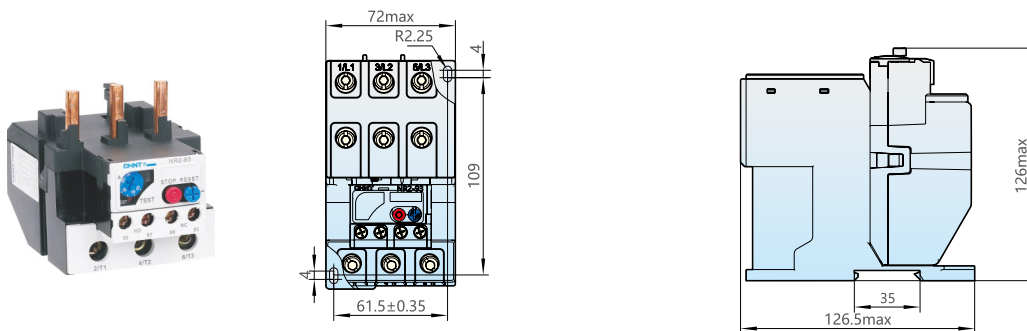

NR2-150(matched with NC2)

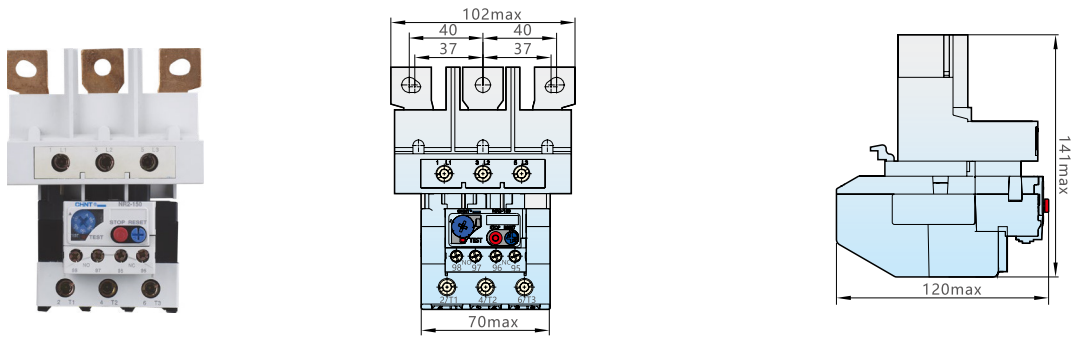

NR2(matched with contactor)

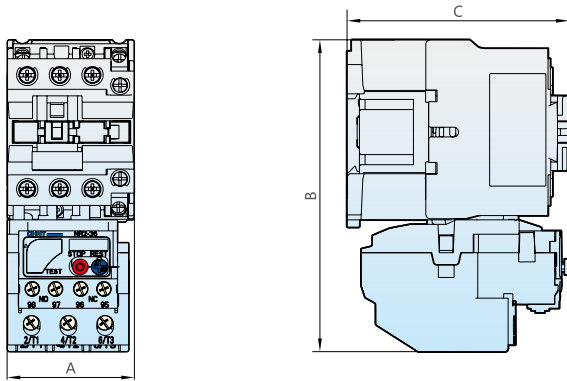





Modle / Size	NR2-11.5	NR2-25				NR2-36	NR2-93			
	NC6-09	NC1-09-25	NC1-32	NC7-09 ~ 22	NC7-25 ~ 32	NC1-32 NC7-32 ~ 38	NC1-40 ~ 65	NC1-80 ~ 95	NC7-40 ~ 65	NC7-80 ~ 95
A max (mm)	50	47	57	47	57	58	77	87	77	87
B max (mm)	119	122	135	125	135	142	178	178	178	178
C max (mm)	74	102	115	102	115	102	128	128	128	128



### 6. Wiring



Items			NR2-11.5	NR2-25	NR2-36	NR2-93	NR2-150
Main circuit	Single core or stranded wire		1~4	1~4	4~10	4~35	25~50
	Wiring screw		M3.5	M4	M4	M10	M6/M8
Auxiliary circuit	Single core or stranded wire		1~2.5	1~2.5	1~2.5	1~2.5	1~2.5
	Wiring screw		M3.5	M3.5	M3.5	M3.5	M3.5

### 7. Accessories

No.		Description	Application
1		MB-1	Incorporate with NR2-11.5 relay to form an independently mounted product
2		MB-2	Incorporate with NR2-25 relay to form an independently mounted product
3		MB-3	Incorporate with NR2-36 relay to form an independently mounted product
4		MB-4	Incorporate with NR2-93 relay to form an independently mounted product

8. Assembly with contactor

Model of overload relay	Rated current(A)	Recommended fuse type (RT16 is recommended)		Model of contactor
		aM	gG	
 NR2-11.5	0.1~0.16	0.25	2	NC6-09
	0.16~0.25	0.5	2	
	0.25~0.4	1	2	
	0.4~0.63	1	2	
	0.63~1	2	4	
	1~1.6	2	4	
	1.25~2	4	6	
	1.6~2.5	4	6	
	2.5~4	6	10	
	4~6	8	16	
	5.5~8	12	20	
	7~10	12	20	
9~13	16	25		
 NR2-25	0.1~0.16	0.25	0.25	NC1-09 NC1-12 NC1-18 NC1-25 NC1-32 NC7-09~22 NC7-25~32
	0.16~0.25	0.5	0.5	
	0.25~0.4	1	1	
	0.4~0.63	1	1	
	0.63~1	2	2	
	1~1.6	2	2	
	1.25~2	4	4	
	1.6~2.5	4	4	
	2.5~4	6	6	
	4~6	8	8	
	5.5~8	12	12	
	7~10	12	12	
	9~13	16	16	
	12~18	20	20	
17~25	25	25		

Model of overload relay	Rated current(A)	Recommended fuse type (RT16 is recommended)		Model of contactor
		aM	gG	
 NR2-36	23~32	40	63	NC1-32 NC7-32~38
	28~36	40	80	
 NR2-93	23~32	40	63	NC1-40 NC1-50 NC1-65 NC1-80 NC1-95 NC7-40~65 NC7-80~95
	30~40	40	100	
	37~50	63	100	
	48~65	63	100	
	55~70	80	125	
	63~80	80	125	
80~93	100	160		
 NR2-150	80~104	125	250	NC2-115 NC2-150
	95~120	125	250	
	110~150	160	250	

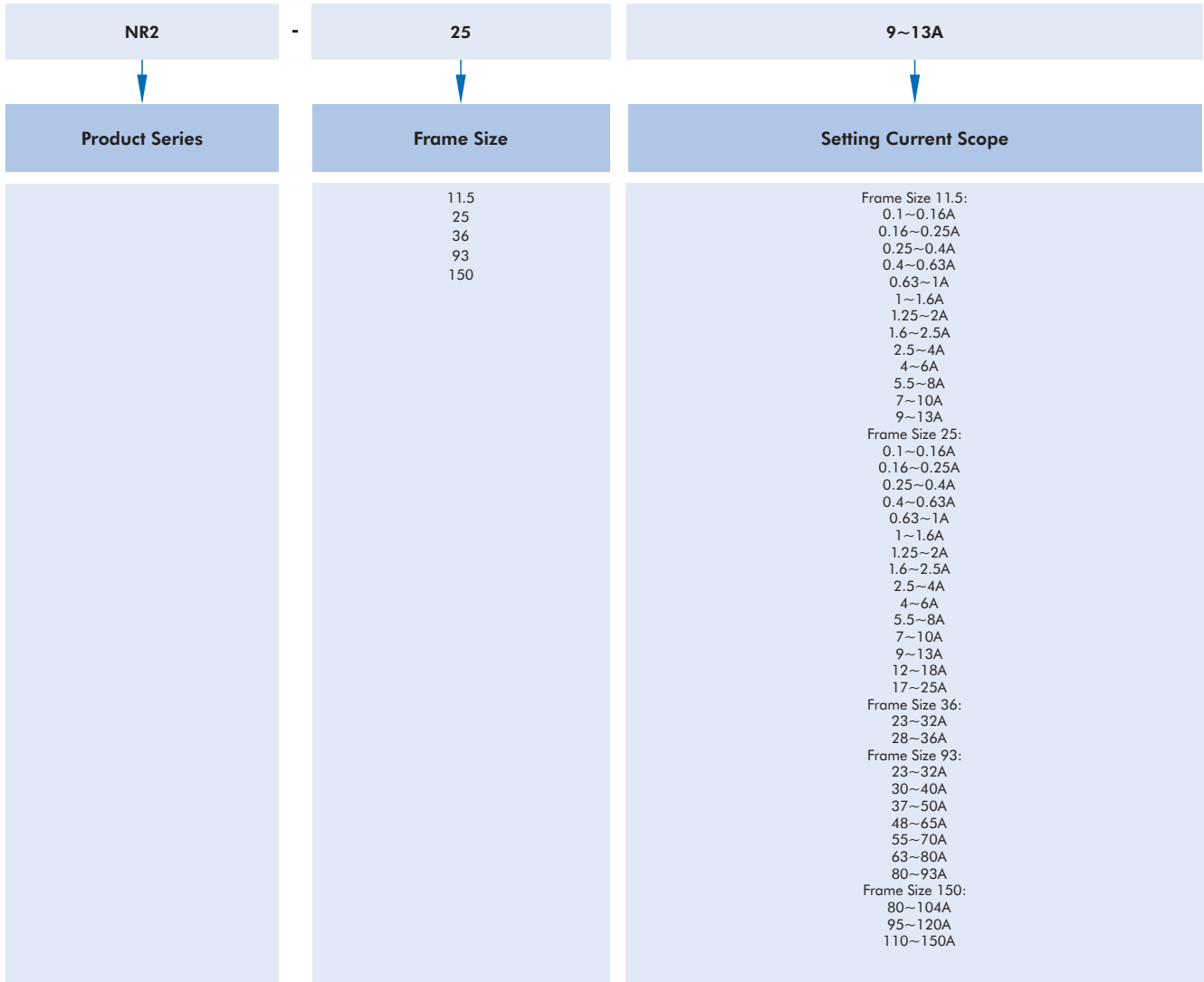

NR2 Relay 13~150

Frame Size	Auxiliary Contacts	Setting Current	Model Description	Code
11.5	1NO+1NC	0.1-0.16A	NR2-11.5/Z 0.1-0.16A	268165
11.5	1NO+1NC	0.16-0.25A	NR2-11.5/Z 0.16-0.25A	268166
11.5	1NO+1NC	0.25-0.4A	NR2-11.5/Z 0.25-0.4A	268167
11.5	1NO+1NC	0.4-0.63A	NR2-11.5/Z 0.4-0.63A	268168
11.5	1NO+1NC	0.63-1A	NR2-11.5/Z 0.63-1A	268169
11.5	1NO+1NC	1-1.6A	NR2-11.5/Z 1-1.6A	268170
11.5	1NO+1NC	1.25-2A	NR2-11.5/Z 1.25-2A	268171
11.5	1NO+1NC	1.6-2.5A	NR2-11.5/Z 1.6-2.5A	268172
11.5	1NO+1NC	2.5-4A	NR2-11.5/Z 2.5-4A	268173
11.5	1NO+1NC	4-6A	NR2-11.5/Z 4-6A	268174
11.5	1NO+1NC	5.5-8A	NR2-11.5/Z 5.5-8A	268175
11.5	1NO+1NC	7-10A	NR2-11.5/Z 7-10A	268176
11.5	1NO+1NC	9-13A	NR2-11.5/Z 9-13A	268177
25	1NO+1NC	9-13A	NR2-25 9-13A	268095
25	1NO+1NC	7-10A	NR2-25 7-10A	268096
25	1NO+1NC	12-18A	NR2-25 12-18A	268097
25	1NO+1NC	1.6-2.5A	NR2-25 1.6-2.5A	268131
25	1NO+1NC	0.10-0.16A	NR2-25 0.10-0.16A	268132
25	1NO+1NC	0.16-0.25A	NR2-25 0.16-0.25A	268133
25	1NO+1NC	0.25-0.4A	NR2-25 0.25-0.4A	268134
25	1NO+1NC	0.4-0.63A	NR2-25 0.4-0.63A	268135
25	1NO+1NC	0.63-1A	NR2-25 0.63-1A	268136
25	1NO+1NC	1-1.6A	NR2-25 1-1.6A	268137
25	1NO+1NC	1.25-2A	NR2-25 1.25-2A	268138
25	1NO+1NC	2.5-4A	NR2-25 2.5-4A	268139
25	1NO+1NC	4-6A	NR2-25 4-6A	268140
25	1NO+1NC	5.5-8A	NR2-25 5.5-8A	268141
25	1NO+1NC	17-25A	NR2-25 17-25A	268142
36	1NO+1NC	23-32A	NR2-36 23-32A	268143
36	1NO+1NC	28-36A	NR2-36 28-36A	268144
93	1NO+1NC	23-32A	NR2-93 23-32A	268145
93	1NO+1NC	30-40A	NR2-93 30-40A	268146
93	1NO+1NC	37-50A	NR2-93 37-50A	268147
93	1NO+1NC	48-65A	NR2-93 48-65A	268148
93	1NO+1NC	55-70A	NR2-93 55-70A	268149
93	1NO+1NC	63-80A	NR2-93 63-80A	268150
93	1NO+1NC	80-93A	NR2-93 80-93A	268151
150	1NO+1NC	80A-104A	NR2-150 80A-104A	268292
150	1NO+1NC	95A-120A	NR2-150 95A-120A	268293
150	1NO+1NC	110A-150A	NR2-150 110A-150A	268294