



CHINT ND16 Signāllampu sērijas Datu lapa

Standarti

IEC/EN 60947-5-1

Aizsardzības pakāpe

IP65 (standarta), IP40, IP20 (modeļiem ar skaņas signālu)

Temperatūras un mitruma diapazons

Darbības temperatūra: -5 °C līdz $+40\text{ °C}$ (vidēji $\leq +35\text{ °C}$ 24 h laikā)

Augstums: $\leq 2000\text{ m}$

Mitrums: $\leq 50\%$ pie $+40\text{ °C}$; $\leq 90\%$ pie $+20\text{ °C}$ (bez kondensācijas)

Piesārņojuma pakāpe: 3

Pārsprieguma kategorija: III

Elektriskie parametri

Parametrs	Vērtība
Izolācijas spriegums (Ui)	660 V
Nominālais darba spriegums (Ue)	AC/DC 6 V – 400 V (atkarībā no modeļa)
Nominālā darba strāva	$\leq 20\text{ mA}$
Kalpošanas laiks	$\geq 30\ 000\text{ h}$
Spilgtums	$\geq 40\text{ cd/m}^2$ (LED tips); $\geq 20\text{ cd/m}^2$ (skaņas signāla tips)
Barošanas diapazons (AC)	$0,85\text{ Ue} - 1,1\text{ Ue}$
Savienojuma griezes moments	Kabeļu spaiļes: $0,8-1,2\text{ N}\cdot\text{m}$; Fiksācijas uzgrieznis: $1,5-1,8\text{ N}\cdot\text{m}$
Kabeļa pieslēgums	$0,5-2,5\text{ mm}^2$ vads, ar 8 mm vadītāja garumu
Montāžas caurums	$\varnothing 22\text{ mm}$ standarta paneļa izmērs

Šis tulkojums sniegts kā palīgmateriāls. Par oficiālu un precīzu informāciju jāuzskata tikai ražotāja oriģinālais dokuments.

LED opcijas

Sprieguma tipi: AC/DC 6 V, 12 V, 24 V, 36 V, 48 V, 110 V, 230 V, 400 V

Pieejamās krāsas: Sarkanā, Zaļā, Dzeltenā, Zilā, Baltā, Oranžā

Lampas formas

Plakana platforma, Apaļa platforma, Arkveida virsma, Kompakta izliekta virsma, Ātrās pieslēgšanas tips

Papildfunkcijas

Prettraucējumu tips (K2), IP65 laikapstākļu aizsardzība (C), Kompakts izmērs (S)

Pieejamie modeļi

ND16-22A / ND16-22AS – Plakana platforma

ND16-22B / ND16-22BS – Apaļa platforma

ND16-22C / ND16-22CS – Arkveida virsma

ND16-22D / ND16-22DS – Izliekta virsma

ND16-22F / ND16-22FS – Skaņas signāla tips

ND16-22L / ND16-22LC – Nepārtraukts skaņas signāls

ND16-22BK – Ātrās pieslēgšanas tips



ND16 Series Indicator Lights

1. General

Degree of protection: IP65,IP40,IP20(Buzzer);
Standard: IEC/EN60947-5-1



2. Operating conditions

2.1 Ambient temperature is $-5^{\circ}\text{C} \sim +40^{\circ}\text{C}$, the average temperature during 24 hours couldn't exceed $+35^{\circ}\text{C}$.

2.2 Altitude: $\leq 2000\text{m}$.

2.3 Atmosphere condition:

Relative humidity of the atmosphere couldn't exceed 50% when the highest temperature is $+40^{\circ}\text{C}$; much higher relative humidity is allowable under the condition of lower temperature, for example, when the temperature reaches $+20^{\circ}\text{C}$, the relative humidity is up to 90%. As for dews, which contingently appear due to change of temperature, special steps should be taken.

2.4 Pollution degree: 3

2.5 Overvoltage category: III

2.6 Tightening torque is $0.8 \sim 1.2\text{N}\cdot\text{m}$ for the cable terminals, and $1.5 \sim 1.8\text{N}\cdot\text{m}$ for the fixing nut. Cross section of the cable connection is $0.5 \sim 2.5\text{mm}^2$, and 8mm conductor length is needed.



3. Technical data

Basic parameters

Rated operational voltage Ue(V)		Rated operational current (mA)	Service life(h)	Brightness (cd/m ²)	Basic color
AC	AC/DC				
400	400	Ie≤20	≥30000	≥40 ≥20(BUZZER)	
230	230				
110	110				
-	48				
-	24				
-	12				
-	36				
-	6				

Note: For AC power supply, the limit voltage range is $0.85U_e \sim 1.1U_e$ between terminals; C:IP65; K2:anti-interference

4. ND16 series indicator

★ Flat Platform-Lampshape (Resistance type)

ND16-22A/2	Lamp-Voltage	Model	Color
	LED	ND16-22A/2 ND16-22A/2K2	○ (W)
	AC/DC 6V,		● (G)
	AC/DC 12V,		● (R)
	AC/DC 24V,		● (Y)
	AC/DC 36V,		● (B)
	AC/DC 48V,		● (O)
	AC/DC 110V,		
	AC/DC 230V, AC/DC 400V		

★ Flat Platform-Lampshape (Resistance type)

ND16-22AS/2	Lamp-Voltage	Model	Color
	LED	ND16-22AS/2	○ (W)
	AC/DC 6V,		● (G)
	AC/DC 12V,		● (R)
	AC/DC 24V,		● (Y)
	AC/DC 36V,		● (B)
	AC/DC 48V,		● (O)

★ Flat Platform-Lampshape (Resistance type)

ND16-22A/4	Lamp-Voltage	Model	Color
	LED	ND16-22A/4 ND16-22A/4K2	○ (W)
	AC 110V,		● (G)
	AC 230V,		● (R)
	AC 400V		● (Y)
			● (B)
			● (O)

★ Flat Platform-Lampshape (Resistance type)

ND16-22AS/4	Lamp-Voltage	Model	Color
	LED	ND16-22AS/4	○ (W)
	AC 110V,		● (G)
	AC 230V,		● (R)
	AC 400V		● (Y)
			● (B)
			● (O)

Dimension(mm)

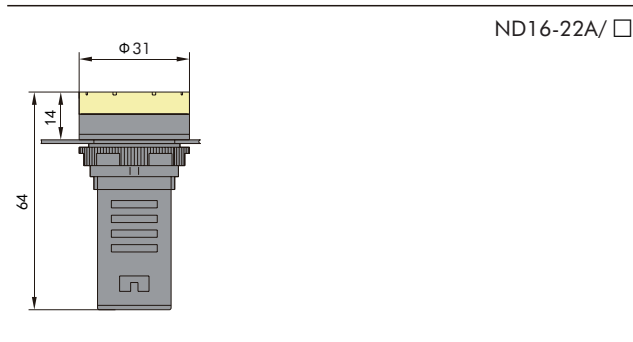

Dimension(mm)

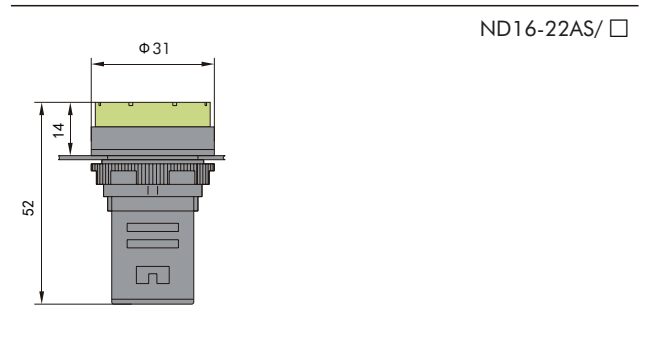

★ Flat Round Platform-Lampshape (Resistance type)

ND16-22B/2	Lamp-Voltage	Model	Color
	LED	ND16-22B/2 ND16-22B/2K2 ND16-22B/2C	○ (W)
	AC/DC 6V,		● (G)
	AC/DC12V,		● (R)
	AC/DC24V,		● (Y)
	AC/DC36V,		● (B)
	AC/DC48V,		● (O)
	AC/DC110V,		
	AC/DC230V, AC/DC400V		

★ Compacted Flat Round Platform-Lampshape (Resistance type)

ND16-22B/2	Lamp-Voltage	Model	Color
	LED	ND16-22BS/2 ND16-22BS/2C	○ (W)
	AC/DC 6V,		● (G)
	AC/DC12V,		● (R)
	AC/DC 24V,		● (Y)
	AC/DC36V,		● (B)
	AC/DC48V		● (O)

★ Flat Round Platform-Lampshape (Capacitance type)

ND16-22B/4	Lamp-Voltage	Model	Color
	LED	ND16-22B/4 ND16-22B/4K2 ND16-22B/4C	○ (W)
	AC 110V,		● (G)
	AC 230V,		● (R)
	AC 400V		● (Y)
			● (B)
			● (O)

★ Compacted Flat Round Platform-Lampshape (Capacitance type)

ND16-22B/4	Lamp-Voltage	Model	Color
	LED	ND16-22BS/4 ND16-22BS/4C	○ (W)
	AC 110V,		● (G)
	AC 230V,		● (R)
	AC 400V		● (Y)
			● (B)
			● (O)

Dimension(mm)

ND16-22B/ □

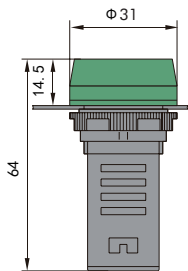

Dimension(mm)

ND16-22BS/ □

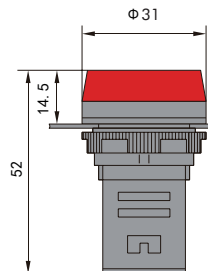

★ Arc Surface ripple-Lampshape (Resistance type)

ND16-22C/2	Lamp-Voltage	Model	Color
	LED	ND16-22C/2 ND16-22C/2K2	○ (W)
	AC/DC 6V,		● (G)
	AC/DC12V,		● (R)
	AC/DC24V,		● (Y)
	AC/DC36V,		● (B)
	AC/DC48V,		● (O)
	AC/DC110V, AC/DC230V, AC/DC400V		

★ Compacted Arc Surface ripple-Lampshape (Resistance type)

ND16-22CS/2	Lamp-Voltage	Model	Color
	LED	ND16-22CS/2	○ (W)
	AC/DC 6V,		● (G)
	AC/DC12V,		● (R)
	AC/DC24V,		● (Y)
	AC/DC36V,		● (B)
	AC/DC48V,		● (O)

★ Arc Surface ripple-Lampshape (Capacitance type)

ND16-22C/4	Lamp-Voltage	Model	Color
	LED	ND16-22C/4 ND16-22C/4K2	○ (W)
	AC 110V,		● (G)
	AC230V,		● (R)
	AC 400V		● (Y)
			● (B)
			● (O)

★ Compacted Arc Surface ripple-Lampshape (Capacitance type)

ND16-22CS/4	Lamp-Voltage	Model	Color
	LED	ND16-22CS/4	○ (W)
	AC 110V,		● (G)
	AC230V,		● (R)
	AC 400V		● (Y)
			● (B)
			● (O)

Dimension(mm)

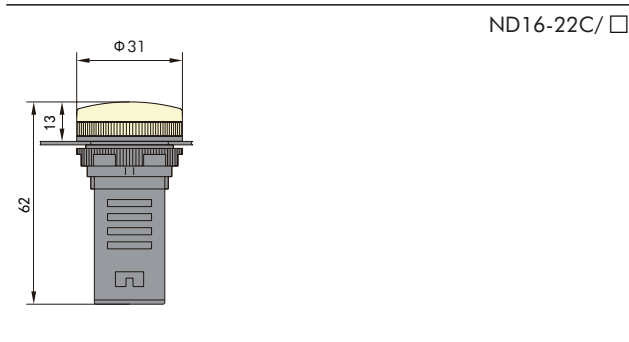

Dimension(mm)

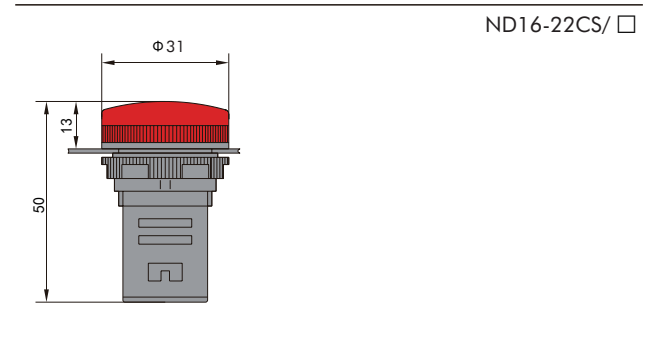

★ Arc Surface Round-Lampshade (Resistance type)

ND16-22D/2	Lamp-Voltage	Model	Color
	LED: AC/DC 6V, AC/DC12V, AC/DC24V, AC/DC36V, AC/DC48V, AC/DC110V, AC/DC230V, AC/DC400V	ND16-22D/2 ND16-22D/2K2 ND16-22D/2C	○ (W)
			● (G)
			● (R)
			● (Y)
			● (B)
			● (O)

★ Compacted Arc Surface Round-Lampshade (Resistance type)

ND16-22DS/2	Lamp-Voltage	Model	Color
	LED: AC/DC 6V, AC/DC12V, AC/DC24V, AC/DC36V, AC/DC48V	ND16-22DS/2 ND16-22DS/2C	○ (W)
			● (G)
			● (R)
			● (Y)
			● (B)
			● (O)

★ Arc Surface Round-Lampshade (Capacitance type)

ND16-22D/4	Lamp-Voltage	Model	Color
	LED AC 110V, AC230V, AC 400V	ND16-22D/4 ND16-22D/4K2 ND16-22D/4C	○ (W)
			● (G)
			● (R)
			● (Y)
			● (B)
			● (O)

★ Compacted Arc Surface Round-Lampshade (Capacitance type)

ND16-22DS/4	Lamp-Voltage	Model	Color
	LED AC 110V, AC 230V, AC 400V	ND16-22DS/4 ND16-22DS/4C	○ (W)
			● (G)
			● (R)
			● (Y)
			● (B)
			● (O)

Dimension(mm)

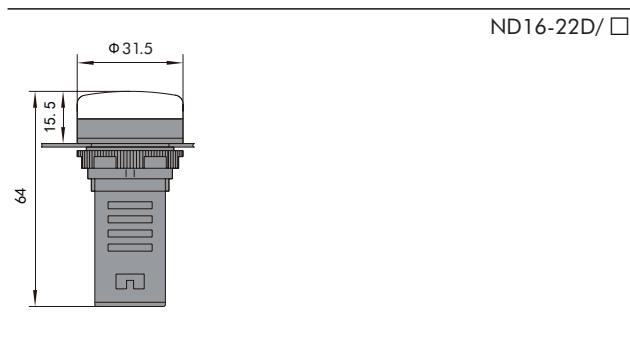

Dimension(mm)

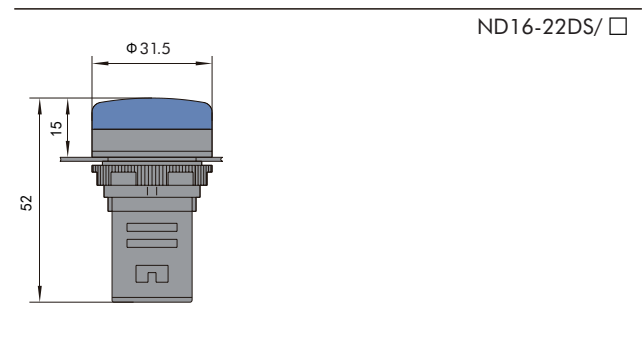

★ Fast connection type (Resistance type)

ND16-22BK/2	Lamp-Voltage	Model	Color
	LED: AC/DC 6V, AC/DC12V, AC/DC24V, AC/DC36V, AC/DC48V, AC/DC110V, AC/DC230V, AC/DC400V	ND16-22BK/2	○ (W)
			● (G)
			● (R)
			● (Y)
			● (B)
			● (O)

★ Fast connection type (Capacitance type)

ND16-22BK/4	Lamp-Voltage	Model	Color
	LED: AC110V AC230V AC400V	ND16-22BK/4	○ (W)
			● (G)
			● (R)
			● (Y)
			● (B)
			● (O)

Dimension(mm)

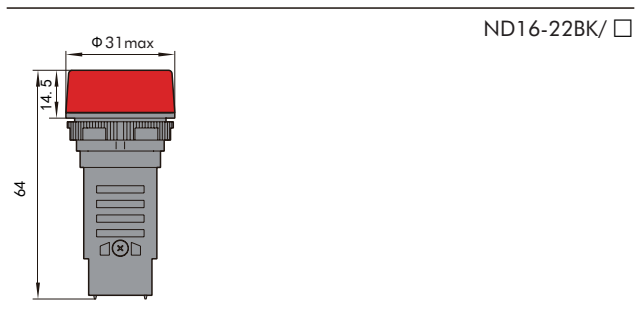

★ Interrupted type

ND16 Buzzer	Model	Color	Voltage
	ND16-22F	●	AC/DC 24V AC/DC 36V AC/DC 48V AC/DC 110V AC230V AC400V
		●	

★ Interrupted & flush type

ND16 Buzzer	Model	Color	Voltage
	ND16-22FS	●	AC/DC 24V AC/DC 36V AC/DC 48V AC/DC 110V AC230V AC400V

★ Continuous type

ND16 Buzzer	Model	Color	Voltage
	ND16-22L	●	AC/DC 24V AC/DC 36V AC/DC 48V AC/DC 110V AC230V AC400V
		●	

★ Continuous & lit type

ND16 Buzzer	Model	Color	Voltage
	ND16-22LC	●	AC/DC 24V AC/DC 36V AC/DC 48V AC/DC 110V AC230V AC400V

Dimension(mm)

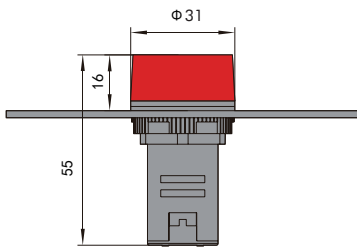

ND16-22F
ND16-22FS
ND16-22L
ND16-22LC

Diameter	Shape of the head	Internal structure	Color or function	Model Description	Code
16mm	Curved surface	Resistance type	White, AC/DC 110V LED	ND16-16D/2 AC/DC 110V WHT	593579
16mm	Curved surface	Resistance type	Red, AC/DC 110V LED	ND16-16D/2 AC/DC 110V RED	593580
16mm	Curved surface	Resistance type	Green, AC/DC 110V LED	ND16-16D/2 AC/DC 110V GRN	593583
16mm	Curved surface	Resistance type	Blue, AC/DC 110V LED	ND16-16D/2 AC/DC 110V BLU	593582
16mm	Curved surface	Resistance type	Yellow, AC/DC 110V LED	ND16-16D/2 AC/DC 110V YEL	593581
16mm	Curved surface	Resistance type	White, AC/DC 12V LED	ND16-16D/2 AC/DC 12V WHT	593584
16mm	Curved surface	Resistance type	Red, AC/DC 12V LED	ND16-16D/2 AC/DC 12V RED	593585
16mm	Curved surface	Resistance type	Green, AC/DC 12V LED	ND16-16D/2 AC/DC 12V GRN	593588
16mm	Curved surface	Resistance type	Blue, AC/DC 12V LED	ND16-16D/2 AC/DC 12V BLU	593587
16mm	Curved surface	Resistance type	Yellow, AC/DC 12V LED	ND16-16D/2 AC/DC 12V YEL	593586
16mm	Curved surface	Resistance type	White, AC/DC 220V LED	ND16-16D/2 AC/DC 220V WHT	593589
16mm	Curved surface	Resistance type	Red, AC/DC 220V LED	ND16-16D/2 AC/DC 220V RED	593590
16mm	Curved surface	Resistance type	Green, AC/DC 220V LED	ND16-16D/2 AC/DC 220V GRN	593593
16mm	Curved surface	Resistance type	Blue, AC/DC 220V LED	ND16-16D/2 AC/DC 220V BLU	593592
16mm	Curved surface	Resistance type	Yellow, AC/DC 220V LED	ND16-16D/2 AC/DC 220V YEL	593591
16mm	Curved surface	Resistance type	White, AC/DC 24V LED	ND16-16D/2 AC/DC 24V WHT	593594
16mm	Curved surface	Resistance type	Red, AC/DC 24V LED	ND16-16D/2 AC/DC 24V RED	593595
16mm	Curved surface	Resistance type	Green, AC/DC 24V LED	ND16-16D/2 AC/DC 24V GRN	593598
16mm	Curved surface	Resistance type	Blue, AC/DC 24V LED	ND16-16D/2 AC/DC 24V BLU	593597
16mm	Curved surface	Resistance type	Yellow, AC/DC 24V LED	ND16-16D/2 AC/DC 24V YEL	593596
16mm	Curved surface	Resistance type	White, AC/DC 36V LED	ND16-16D/2 AC/DC 36V WHT	593599
16mm	Curved surface	Resistance type	Red, AC/DC 36V LED	ND16-16D/2 AC/DC 36V RED	593600
16mm	Curved surface	Resistance type	Green, AC/DC 36V LED	ND16-16D/2 AC/DC 36V GRN	593603
16mm	Curved surface	Resistance type	Blue, AC/DC 36V LED	ND16-16D/2 AC/DC 36V BLU	593602
16mm	Curved surface	Resistance type	Yellow, AC/DC 36V LED	ND16-16D/2 AC/DC 36V YEL	593601
16mm	Curved surface	Resistance type	White, AC/DC 48V LED	ND16-16D/2 AC/DC 48V WHT	593604
16mm	Curved surface	Resistance type	Red, AC/DC 48V LED	ND16-16D/2 AC/DC 48V RED	593605
16mm	Curved surface	Resistance type	Green, AC/DC 48V LED	ND16-16D/2 AC/DC 48V GRN	593608
16mm	Curved surface	Resistance type	Blue, AC/DC 48V LED	ND16-16D/2 AC/DC 48V BLU	593607
16mm	Curved surface	Resistance type	Yellow, AC/DC 48V LED	ND16-16D/2 AC/DC 48V YEL	593606
16mm	Curved surface	Resistance type	White, AC/DC 6V LED	ND16-16D/2 AC/DC 6V WHT	593609
16mm	Curved surface	Resistance type	Red, AC/DC 6V LED	ND16-16D/2 AC/DC 6V RED	593610
16mm	Curved surface	Resistance type	Green, AC/DC 6V LED	ND16-16D/2 AC/DC 6V GRN	593613
16mm	Curved surface	Resistance type	Blue, AC/DC 6V LED	ND16-16D/2 AC/DC 6V BLU	593612
16mm	Curved surface	Resistance type	Yellow, AC/DC 6V LED	ND16-16D/2 AC/DC 6V YEL	593611
16mm	Curved surface	Resistance and capacitance type	White, AC 110V LED	ND16-16D/4 AC 110V WHT	593614
16mm	Curved surface	Resistance and capacitance type	Red, AC 110V LED	ND16-16D/4 AC 110V RED	593615
16mm	Curved surface	Resistance and capacitance type	Green, AC 110V LED	ND16-16D/4 AC 110V GRN	593618
16mm	Curved surface	Resistance and capacitance type	Blue, AC 110V LED	ND16-16D/4 AC 110V BLU	593617
16mm	Curved surface	Resistance and capacitance type	Yellow, AC 110V LED	ND16-16D/4 AC 110V YEL	593616
16mm	Curved surface	Resistance and capacitance type	White, AC 220V LED	ND16-16D/4 AC 220V WHT	593619
16mm	Curved surface	Resistance and capacitance type	Red, AC 220V LED	ND16-16D/4 AC 220V RED	593620
16mm	Curved surface	Resistance and capacitance type	Green, AC 220V LED	ND16-16D/4 AC 220V GRN	593623
16mm	Curved surface	Resistance and capacitance type	Blue, AC 220V LED	ND16-16D/4 AC 220V BLU	593622

Diameter	Shape of the head	Internal structure	Color or function	Model Description	Code
16mm	Curved surface	Resistance and capacitance type	Yellow, AC 220V LED	ND16-16D/4 AC 220V YEL	593621
16mm	Curved surface	Resistance and capacitance type	White, AC 380V LED	ND16-16D/4 AC 380V WHT	593624
16mm	Curved surface	Resistance and capacitance type	Red, AC 380V LED	ND16-16D/4 AC 380V RED	593625
16mm	Curved surface	Resistance and capacitance type	Green, AC 380V LED	ND16-16D/4 AC 380V GRN	593628
16mm	Curved surface	Resistance and capacitance type	Blue, AC 380V LED	ND16-16D/4 AC 380V BLU	593627
16mm	Curved surface	Resistance and capacitance type	Yellow, AC 380V LED	ND16-16D/4 AC 380V YEL	593626
22mm	Flat surface, with notches	Resistance type	White, AC/DC 110V LED	ND16-22A/2 110V WHT	592746
22mm	Flat surface, with notches	Resistance type	Red, AC/DC 110V LED	ND16-22A/2 110V RED	592748
22mm	Flat surface, with notches	Resistance type	Green, AC/DC 110V LED	ND16-22A/2 110V GRN	592750
22mm	Flat surface, with notches	Resistance type	Blue, AC/DC 110V LED	ND16-22A/2 110V BLU	592747
22mm	Flat surface, with notches	Resistance type	Yellow, AC/DC 110V LED	ND16-22A/2 110V YEL	592749
22mm	Flat surface, with notches	Resistance type	White, AC/DC 12V LED	ND16-22A/2 12V WHT	592731
22mm	Flat surface, with notches	Resistance type	Red, AC/DC 12V LED	ND16-22A/2 12V RED	592733
22mm	Flat surface, with notches	Resistance type	Green, AC/DC 12V LED	ND16-22A/2 12V GRN	592735
22mm	Flat surface, with notches	Resistance type	Blue, AC/DC 12V LED	ND16-22A/2 12V BLU	592732
22mm	Flat surface, with notches	Resistance type	Yellow, AC/DC 12V LED	ND16-22A/2 12V YEL	592734
22mm	Flat surface, with notches	Resistance type	White, AC/DC 220V LED	ND16-22A/2 220V WHT	592751
22mm	Flat surface, with notches	Resistance type	Red, AC/DC 220V LED	ND16-22A/2 220V RED	592753
22mm	Flat surface, with notches	Resistance type	Green, AC/DC 220V LED	ND16-22A/2 220V GRN	592755
22mm	Flat surface, with notches	Resistance type	Blue, AC/DC 220V LED	ND16-22A/2 220V BLU	592752
22mm	Flat surface, with notches	Resistance type	Yellow, AC/DC 220V LED	ND16-22A/2 220V YEL	592754
22mm	Flat surface, with notches	Resistance type	White, AC/DC 230V LED	ND16-22A/2 230V WHT	593432
22mm	Flat surface, with notches	Resistance type	Red, AC/DC 230V LED	ND16-22A/2 230V GRN	593433
22mm	Flat surface, with notches	Resistance type	Green, AC/DC 230V LED	ND16-22A/2 230V BLU	593435
22mm	Flat surface, with notches	Resistance type	Blue, AC/DC 230V LED	ND16-22A/2 230V YEL	593434
22mm	Flat surface, with notches	Resistance type	White, AC/DC 24V LED	ND16-22A/2 24V WHT	592736
22mm	Flat surface, with notches	Resistance type	Red, AC/DC 24V LED	ND16-22A/2 24V RED	592738
22mm	Flat surface, with notches	Resistance type	Green, AC/DC 24V LED	ND16-22A/2 24V GRN	592740
22mm	Flat surface, with notches	Resistance type	Blue, AC/DC 24V LED	ND16-22A/2 24V BLU	592737
22mm	Flat surface, with notches	Resistance type	Yellow, AC/DC 24V LED	ND16-22A/2 24V YEL	592739
22mm	Flat surface, with notches	Resistance type	White, AC/DC 36V LED	ND16-22A/2 36V WHT	105520
22mm	Flat surface, with notches	Resistance type	Red, AC/DC 36V LED	ND16-22A/2 36V RED	105516
22mm	Flat surface, with notches	Resistance type	Green, AC/DC 36V LED	ND16-22A/2 36V GRN	105518
22mm	Flat surface, with notches	Resistance type	Blue, AC/DC 36V LED	ND16-22A/2 36V BLU	105519
22mm	Flat surface, with notches	Resistance type	Yellow, AC/DC 36V LED	ND16-22A/2 36V YEL	105517
22mm	Flat surface, with notches	Resistance type	White, AC/DC 380V LED	ND16-22A/2 380V WHT	592756
22mm	Flat surface, with notches	Resistance type	Red, AC/DC 380V LED	ND16-22A/2 380V RED	592758
22mm	Flat surface, with notches	Resistance type	Green, AC/DC 380V LED	ND16-22A/2 380V GRN	592760
22mm	Flat surface, with notches	Resistance type	Blue, AC/DC 380V LED	ND16-22A/2 380V BLU	592757
22mm	Flat surface, with notches	Resistance type	Yellow, AC/DC 380V LED	ND16-22A/2 380V YEL	592759
22mm	Flat surface, with notches	Resistance type	White, AC/DC 400V LED	ND16-22A/2 400V WHT	593917
22mm	Flat surface, with notches	Resistance type	Red, AC/DC 400V LED	ND16-22A/2 400V RED	593913
22mm	Flat surface, with notches	Resistance type	Green, AC/DC 400V LED	ND16-22A/2 400V GRN	593915
22mm	Flat surface, with notches	Resistance type	Blue, AC/DC 400V LED	ND16-22A/2 400V BLU	593916

Diameter	Shape of the head	Internal structure	Color or function	Model Description	Code
22mm	Flat surface, with notches	Resistance type	Yellow, AC/DC 400V LED	ND16-22A/2 400V YEL	593914
22mm	Flat surface, with notches	Resistance type	White, AC/DC 48V LED	ND16-22A/2 48V WHT	592741
22mm	Flat surface, with notches	Resistance type	Red, AC/DC 48V LED	ND16-22A/2 48V RED	592743
22mm	Flat surface, with notches	Resistance type	Green, AC/DC 48V LED	ND16-22A/2 48V GRN	592745
22mm	Flat surface, with notches	Resistance type	Blue, AC/DC 48V LED	ND16-22A/2 48V BLU	592742
22mm	Flat surface, with notches	Resistance type	Yellow, AC/DC 48V LED	ND16-22A/2 48V YEL	592744
22mm	Flat surface, with notches	Resistance type	White, AC/DC 6V LED	ND16-22A/2 6V WHT	592726
22mm	Flat surface, with notches	Resistance type	Red, AC/DC 6V LED	ND16-22A/2 6V RED	592728
22mm	Flat surface, with notches	Resistance type	Green, AC/DC 6V LED	ND16-22A/2 6V GRN	592730
22mm	Flat surface, with notches	Resistance type	Blue, AC/DC 6V LED	ND16-22A/2 6V BLU	592727
22mm	Flat surface, with notches	Resistance type	Yellow, AC/DC 6V LED	ND16-22A/2 6V YEL	592729
22mm	Flat surface, with notches	Resistance and capacitance type	White, AC 110V LED	ND16-22A/4 110V WHT	592606
22mm	Flat surface, with notches	Resistance and capacitance type	Red, AC 110V LED	ND16-22A/4 110V RED	592608
22mm	Flat surface, with notches	Resistance and capacitance type	Green, AC 110V LED	ND16-22A/4 110V GRN	592610
22mm	Flat surface, with notches	Resistance and capacitance type	Blue, AC 110V LED	ND16-22A/4 110V BLU	592607
22mm	Flat surface, with notches	Resistance and capacitance type	Yellow, AC 110V LED	ND16-22A/4 110V YEL	592609
22mm	Flat surface, with notches	Resistance and capacitance type	White, AC 220V LED	ND16-22A/4 220V WHT	592614
22mm	Flat surface, with notches	Resistance and capacitance type	Red, AC 220V LED	ND16-22A/4 220V RED	592611
22mm	Flat surface, with notches	Resistance and capacitance type	Green, AC 220V LED	ND16-22A/4 220V GRN	592612
22mm	Flat surface, with notches	Resistance and capacitance type	Blue, AC 220V LED	ND16-22A/4 220V BLU	592615
22mm	Flat surface, with notches	Resistance and capacitance type	Yellow, AC 220V LED	ND16-22A/4 220V YEL	592613
22mm	Flat surface, with notches	Resistance and capacitance type	Orange, AC 230V LED	ND16-22A/4 230V ORG	110624
22mm	Flat surface, with notches	Resistance and capacitance type	White, AC 230V LED	ND16-22A/4 230V WHT	593454
22mm	Flat surface, with notches	Resistance and capacitance type	Red, AC 230V LED	ND16-22A/4 230V RED	593453
22mm	Flat surface, with notches	Resistance and capacitance type	Green, AC 230V LED	ND16-22A/4 230V GRN	593456
22mm	Flat surface, with notches	Resistance and capacitance type	Blue, AC 230V LED	ND16-22A/4 230V BLU	593455
22mm	Flat surface, with notches	Resistance and capacitance type	Yellow, AC 230V LED	ND16-22A/4 230V YEL	593452
22mm	Flat surface, with notches	Resistance and capacitance type	White, AC 380V LED	ND16-22A/4 380V WHT	592620
22mm	Flat surface, with notches	Resistance and capacitance type	Red, AC 380V LED	ND16-22A/4 380V RED	592616
22mm	Flat surface, with notches	Resistance and capacitance type	Green, AC 380V LED	ND16-22A/4 380V GRN	592617
22mm	Flat surface, with notches	Resistance and capacitance type	Blue, AC 380V LED	ND16-22A/4 380V BLU	592619
22mm	Flat surface, with notches	Resistance and capacitance type	Yellow, AC 380V LED	ND16-22A/4 380V YEL	592618
22mm	Flat surface, with notches	Resistance type, compact	White, AC/DC 12V LED	ND16-22AS/2 12V WHT	592871
22mm	Flat surface, with notches	Resistance type, compact	Red, AC/DC 12V LED	ND16-22AS/2 12V RED	592873
22mm	Flat surface, with notches	Resistance type, compact	Green, AC/DC 12V LED	ND16-22AS/2 12V GRN	592875
22mm	Flat surface, with notches	Resistance type, compact	Blue, AC/DC 12V LED	ND16-22AS/2 12V BLU	592872
22mm	Flat surface, with notches	Resistance type, compact	Yellow, AC/DC 12V LED	ND16-22AS/2 12V YEL	592874
22mm	Flat surface, with notches	Resistance type, compact	White, AC/DC 24V LED	ND16-22AS/2 24V WHT	592876
22mm	Flat surface, with notches	Resistance type, compact	Red, AC/DC 24V LED	ND16-22AS/2 24V RED	592878
22mm	Flat surface, with notches	Resistance type, compact	Green, AC/DC 24V LED	ND16-22AS/2 24V GRN	592880
22mm	Flat surface, with notches	Resistance type, compact	Blue, AC/DC 24V LED	ND16-22AS/2 24V BLU	592877
22mm	Flat surface, with notches	Resistance type, compact	Yellow, AC/DC 24V LED	ND16-22AS/2 24V YEL	592879
22mm	Flat surface, with notches	Resistance type, compact	White, AC/DC 48V LED	ND16-22AS/2 48V WHT	592881
22mm	Flat surface, with notches	Resistance type, compact	Red, AC/DC 48V LED	ND16-22AS/2 48V RED	592883

Diameter	Shape of the head	Internal structure	Color or function	Model Description	Code
22mm	Flat surface, with notches	Resistance type, compact	Green, AC/DC 48V LED	ND16-22AS/2 48V GRN	592885
22mm	Flat surface, with notches	Resistance type, compact	Blue, AC/DC 48V LED	ND16-22AS/2 48V BLU	592882
22mm	Flat surface, with notches	Resistance type, compact	Yellow, AC/DC 48V LED	ND16-22AS/2 48V YEL	592884
22mm	Flat surface, with notches	Resistance type, compact	White, AC/DC 6V LED	ND16-22AS/2 6V WHT	592866
22mm	Flat surface, with notches	Resistance type, compact	Red, AC/DC 6V LED	ND16-22AS/2 6V RED	592868
22mm	Flat surface, with notches	Resistance type, compact	Green, AC/DC 6V LED	ND16-22AS/2 6V GRN	592870
22mm	Flat surface, with notches	Resistance type, compact	Blue, AC/DC 6V LED	ND16-22AS/2 6V BLU	592867
22mm	Flat surface, with notches	Resistance type, compact	Yellow, AC/DC 6V LED	ND16-22AS/2 6V YEL	592869
22mm	Flat surface, with notches	Resistance and capacitance type, compact	White, AC 110V LED	ND16-22AS/4 110V WHT	592666
22mm	Flat surface, with notches	Resistance and capacitance type, compact	Red, AC 110V LED	ND16-22AS/4 110V RED	592669
22mm	Flat surface, with notches	Resistance and capacitance type, compact	Green, AC 110V LED	ND16-22AS/4 110V GRN	592668
22mm	Flat surface, with notches	Resistance and capacitance type, compact	Blue, AC 110V LED	ND16-22AS/4 110V BLU	592667
22mm	Flat surface, with notches	Resistance and capacitance type, compact	Yellow, AC 110V LED	ND16-22AS/4 110V YEL	592670
22mm	Flat surface, with notches	Resistance and capacitance type, compact	White, AC 220V LED	ND16-22AS/4 220V WHT	592671
22mm	Flat surface, with notches	Resistance and capacitance type, compact	Red, AC 220V LED	ND16-22AS/4 220V RED	592674
22mm	Flat surface, with notches	Resistance and capacitance type, compact	Green, AC 220V LED	ND16-22AS/4 220V GRN	592673
22mm	Flat surface, with notches	Resistance and capacitance type, compact	Blue, AC 220V LED	ND16-22AS/4 220V BLU	592672
22mm	Flat surface, with notches	Resistance and capacitance type, compact	Yellow, AC 220V LED	ND16-22AS/4 220V YEL	592675
22mm	Flat surface, with notches	Resistance and capacitance type, compact	Green, AC 230V LED	ND16-22AS/4 230V GRN	593413
22mm	Flat surface, with notches	Resistance and capacitance type, compact	Blue, AC 230V LED	ND16-22AS/4 230V BLU	593925
22mm	Flat surface, with notches	Resistance and capacitance type, compact	White, AC 380V LED	ND16-22AS/4 380V WHT	592676
22mm	Flat surface, with notches	Resistance and capacitance type, compact	Red, AC 380V LED	ND16-22AS/4 380V RED	592679
22mm	Flat surface, with notches	Resistance and capacitance type, compact	Green, AC 380V LED	ND16-22AS/4 380V GRN	592678
22mm	Flat surface, with notches	Resistance and capacitance type, compact	Blue, AC 380V LED	ND16-22AS/4 380V BLU	592677
22mm	Flat surface, with notches	Resistance and capacitance type, compact	Yellow, AC 380V LED	ND16-22AS/4 380V YEL	592680
22mm	Flat surface	Resistance type	Orange, AC/DC 110V LED	ND16-22B/2 110V ORG	593437
22mm	Flat surface	Resistance type	White, AC/DC 110V LED	ND16-22B/2 110V WHT	592781
22mm	Flat surface	Resistance type	Red, AC/DC 110V LED	ND16-22B/2 110V RED	592783
22mm	Flat surface	Resistance type	Green, AC/DC 110V LED	ND16-22B/2 110V GRN	592785
22mm	Flat surface	Resistance type	Blue, AC/DC 110V LED	ND16-22B/2 110V BLU	592782
22mm	Flat surface	Resistance type	Yellow, AC/DC 110V LED	ND16-22B/2 110V YEL	592784
22mm	Flat surface	Resistance type	Orange, AC/DC 12V LED	ND16-22B/2 12V ORG	267918
22mm	Flat surface	Resistance type	White, AC/DC 12V LED	ND16-22B/2 12V WHT	592766
22mm	Flat surface	Resistance type	Red, AC/DC 12V LED	ND16-22B/2 12V RED	592768
22mm	Flat surface	Resistance type	Green, AC/DC 12V LED	ND16-22B/2 12V GRN	592770
22mm	Flat surface	Resistance type	Blue, AC/DC 12V LED	ND16-22B/2 12V BLU	592767
22mm	Flat surface	Resistance type	Yellow, AC/DC 12V LED	ND16-22B/2 12V YEL	592769
22mm	Flat surface	Resistance type	Orange, AC/DC 220V LED	ND16-22B/2 220V ORG	593438
22mm	Flat surface	Resistance type	White, AC/DC 220V LED	ND16-22B/2 220V WHT	592786
22mm	Flat surface	Resistance type	Red, AC/DC 220V LED	ND16-22B/2 220V RED	592788
22mm	Flat surface	Resistance type	Green, AC/DC 220V LED	ND16-22B/2 220V GRN	592790
22mm	Flat surface	Resistance type	Blue, AC/DC 220V LED	ND16-22B/2 220V BLU	592787
22mm	Flat surface	Resistance type	Yellow, AC/DC 220V LED	ND16-22B/2 220V YEL	592789
22mm	Flat surface, with notches	Resistance type	Blue, AC/DC 400V LED	ND16-22A/2 400V BLU	593916

Diameter	Shape of the head	Internal structure	Color or function	Model Description	Code
22mm	Flat surface	Resistance type	Orange, AC/DC 230V LED	ND16-22B/2 230V ORG	268677
22mm	Flat surface	Resistance type	White, AC/DC 230V LED	ND16-22B/2 230V WHT	593312
22mm	Flat surface	Resistance type	Red, AC/DC 230V LED	ND16-22B/2 230V RED	593309
22mm	Flat surface	Resistance type	Green, AC/DC 230V LED	ND16-22B/2 230V GRN	593310
22mm	Flat surface	Resistance type	Blue, AC/DC 230V LED	ND16-22B/2 230V BLU	593313
22mm	Flat surface	Resistance type	Yellow, AC/DC 230V LED	ND16-22B/2 230V YEL	593311
22mm	Flat surface	Resistance type	Orange, AC/DC 240V LED	ND16-22B/2 240V ORG	828358
22mm	Flat surface	Resistance type	White, AC/DC 240V LED	ND16-22B/2 240V WHT	828359
22mm	Flat surface	Resistance type	Red, AC/DC 240V LED	ND16-22B/2 240V RED	593439
22mm	Flat surface	Resistance type	Green, AC/DC 240V LED	ND16-22B/2 240V GRN	593440
22mm	Flat surface	Resistance type	Blue, AC/DC 240V LED	ND16-22B/2 240V BLU	268718
22mm	Flat surface	Resistance type	Yellow, AC/DC 240V LED	ND16-22B/2 240V YEL	593441
22mm	Flat surface	Resistance type	Orange, AC/DC 24V LED	ND16-22B/2 24V ORG	267931
22mm	Flat surface	Resistance type	White, AC/DC 24V LED	ND16-22B/2 24V WHT	592771
22mm	Flat surface	Resistance type	Red, AC/DC 24V LED	ND16-22B/2 24V RED	592773
22mm	Flat surface	Resistance type	Green, AC/DC 24V LED	ND16-22B/2 24V GRN	592775
22mm	Flat surface	Resistance type	Blue, AC/DC 24V LED	ND16-22B/2 24V BLU	592772
22mm	Flat surface	Resistance type	Yellow, AC/DC 24V LED	ND16-22B/2 24V YEL	592774
22mm	Flat surface	Resistance type	Orange, AC/DC 36V LED	ND16-22B/2 36V ORG	267954
22mm	Flat surface	Resistance type	White, AC/DC 36V LED	ND16-22B/2 36V WHT	267953
22mm	Flat surface	Resistance type	Red, AC/DC 36V LED	ND16-22B/2 36V RED	267949
22mm	Flat surface	Resistance type	Green, AC/DC 36V LED	ND16-22B/2 36V GRN	267951
22mm	Flat surface	Resistance type	Blue, AC/DC 36V LED	ND16-22B/2 36V BLU	267952
22mm	Flat surface	Resistance type	Yellow, AC/DC 36V LED	ND16-22B/2 36V YEL	267950
22mm	Flat surface	Resistance type	Orange, AC/DC 380V LED	ND16-22B/2 380V ORG	268762
22mm	Flat surface	Resistance type	White, AC/DC 380V LED	ND16-22B/2 380V WHT	592791
22mm	Flat surface	Resistance type	Red, AC/DC 380V LED	ND16-22B/2 380V RED	592793
22mm	Flat surface	Resistance type	Green, AC/DC 380V LED	ND16-22B/2 380V GRN	592795
22mm	Flat surface	Resistance type	Blue, AC/DC 380V LED	ND16-22B/2 380V BLU	592792
22mm	Flat surface	Resistance type	Yellow, AC/DC 380V LED	ND16-22B/2 380V YEL	592794
22mm	Flat surface	Resistance type	Orange, AC/DC 400V LED	ND16-22B/2 400V ORG	268819
22mm	Flat surface	Resistance type	White, AC/DC 400V LED	ND16-22B/2 400V WHT	268818
22mm	Flat surface	Resistance type	Red, AC/DC 400V LED	ND16-22B/2 400V RED	268814
22mm	Flat surface	Resistance type	Green, AC/DC 400V LED	ND16-22B/2 400V GRN	268816
22mm	Flat surface	Resistance type	Blue, AC/DC 400V LED	ND16-22B/2 400V BLU	268817
22mm	Flat surface	Resistance type	Yellow, AC/DC 400V LED	ND16-22B/2 400V YEL	268815
22mm	Flat surface	Resistance type	Orange, AC/DC 48V LED	ND16-22B/2 48V ORG	267967
22mm	Flat surface	Resistance type	White, AC/DC 48V LED	ND16-22B/2 48V WHT	592776
22mm	Flat surface	Resistance type	Red, AC/DC 48V LED	ND16-22B/2 48V RED	592778
22mm	Flat surface	Resistance type	Green, AC/DC 48V LED	ND16-22B/2 48V GRN	592780
22mm	Flat surface	Resistance type	Blue, AC/DC 48V LED	ND16-22B/2 48V BLU	592777
22mm	Flat surface	Resistance type	Yellow, AC/DC 48V LED	ND16-22B/2 48V YEL	592779
22mm	Flat surface	Resistance type	Orange, AC/DC 6V LED	ND16-22B/2 6V ORG	267909
22mm	Flat surface	Resistance type	White, AC/DC 6V LED	ND16-22B/2 6V WHT	592761

Diameter	Shape of the head	Internal structure	Color or function	Model Description	Code
22mm	Flat surface	Resistance type	Red, AC/DC 6V LED	ND16-22B/2 6V RED	592763
22mm	Flat surface	Resistance type	Green, AC/DC 6V LED	ND16-22B/2 6V GRN	592765
22mm	Flat surface	Resistance type	Blue, AC/DC 6V LED	ND16-22B/2 6V BLU	592762
22mm	Flat surface	Resistance type	Yellow, AC/DC 6V LED	ND16-22B/2 6V YEL	592764
22mm	Flat surface	Resistance type	Orange, AC/DC 110V LED, IP65	ND16-22B/2C 110V ORG	267992
22mm	Flat surface	Resistance type	White, AC/DC 110V LED, IP65	ND16-22B/2C 110V WHT	267991
22mm	Flat surface	Resistance type	Red, AC/DC 110V LED, IP65	ND16-22B/2C 110V RED	267987
22mm	Flat surface	Resistance type	Green, AC/DC 110V LED, IP65	ND16-22B/2C 110V GRN	267989
22mm	Flat surface	Resistance type	Blue, AC/DC 110V LED, IP65	ND16-22B/2C 110V BLU	267990
22mm	Flat surface	Resistance type	Yellow, AC/DC 110V LED, IP65	ND16-22B/2C 110V YEL	267988
22mm	Flat surface	Resistance type	Orange, AC/DC 12V LED, IP65	ND16-22B/2C 12V ORG	267924
22mm	Flat surface	Resistance type	White, AC/DC 12V LED, IP65	ND16-22B/2C 12V WHT	267923
22mm	Flat surface	Resistance type	Red, AC/DC 12V LED, IP65	ND16-22B/2C 12V RED	267919
22mm	Flat surface	Resistance type	Green, AC/DC 12V LED, IP65	ND16-22B/2C 12V GRN	267921
22mm	Flat surface	Resistance type	Blue, AC/DC 12V LED, IP65	ND16-22B/2C 12V BLU	267922
22mm	Flat surface	Resistance type	Yellow, AC/DC 12V LED, IP65	ND16-22B/2C 12V YEL	267920
22mm	Flat surface	Resistance type	Orange, AC/DC 220V LED, IP65	ND16-22B/2C 220V ORG	268651
22mm	Flat surface	Resistance type	White, AC/DC 220V LED, IP65	ND16-22B/2C 220V WHT	268650
22mm	Flat surface	Resistance type	Red, AC/DC 220V LED, IP65	ND16-22B/2C 220V RED	268646
22mm	Flat surface	Resistance type	Green, AC/DC 220V LED, IP65	ND16-22B/2C 220V GRN	268648
22mm	Flat surface	Resistance type	Blue, AC/DC 220V LED, IP65	ND16-22B/2C 220V BLU	268649
22mm	Flat surface	Resistance type	Yellow, AC/DC 220V LED, IP65	ND16-22B/2C 220V YEL	268647
22mm	Flat surface	Resistance type	Orange, AC/DC 230V LED, IP65	ND16-22B/2C 230V ORG	268683
22mm	Flat surface	Resistance type	White, AC/DC 230V LED, IP65	ND16-22B/2C 230V WHT	268682
22mm	Flat surface	Resistance type	Red, AC/DC 230V LED, IP65	ND16-22B/2C 230V RED	268678
22mm	Flat surface	Resistance type	Green, AC/DC 230V LED, IP65	ND16-22B/2C 230V GRN	268680
22mm	Flat surface	Resistance type	Blue, AC/DC 230V LED, IP65	ND16-22B/2C 230V BLU	268681
22mm	Flat surface	Resistance type	Yellow, AC/DC 230V LED, IP65	ND16-22B/2C 230V YEL	268679
22mm	Flat surface	Resistance type	Orange, AC/DC 240V LED, IP65	ND16-22B/2C 240V ORG	268724
22mm	Flat surface	Resistance type	White, AC/DC 240V LED, IP65	ND16-22B/2C 240V WHT	268723
22mm	Flat surface	Resistance type	Red, AC/DC 240V LED, IP65	ND16-22B/2C 240V RED	268719
22mm	Flat surface	Resistance type	Green, AC/DC 240V LED, IP65	ND16-22B/2C 240V GRN	268721
22mm	Flat surface	Resistance type	Blue, AC/DC 240V LED, IP65	ND16-22B/2C 240V BLU	268722
22mm	Flat surface	Resistance type	Yellow, AC/DC 240V LED, IP65	ND16-22B/2C 240V YEL	268720
22mm	Flat surface	Resistance type	White, AC/DC 24V LED, IP65	ND16-22B/2C 24V WHT	267930
22mm	Flat surface	Resistance type	Red, AC/DC 24V LED, IP65	ND16-22B/2C 24V RED	267926
22mm	Flat surface	Resistance type	Green, AC/DC 24V LED, IP65	ND16-22B/2C 24V GRN	267928
22mm	Flat surface	Resistance type	Blue, AC/DC 24V LED, IP65	ND16-22B/2C 24V BLU	267929
22mm	Flat surface	Resistance type	Yellow, AC/DC 24V LED, IP65	ND16-22B/2C 24V YEL	267927
22mm	Flat surface	Resistance type	Orange, AC/DC 36V LED, IP65	ND16-22B/2C 36V ORG	267960
22mm	Flat surface	Resistance type	White, AC/DC 36V LED, IP65	ND16-22B/2C 36V WHT	267959
22mm	Flat surface	Resistance type	Red, AC/DC 36V LED, IP65	ND16-22B/2C 36V RED	267955
22mm	Flat surface	Resistance type	Green, AC/DC 36V LED, IP65	ND16-22B/2C 36V GRN	267957
22mm	Flat surface	Resistance type	Blue, AC/DC 36V LED, IP65	ND16-22B/2C 36V BLU	267958

Diameter	Shape of the head	Internal structure	Color or function	Model Description	Code
22mm	Flat surface	Resistance type	Yellow, AC/DC 36V LED, IP65	ND16-22B/2C 36V YEL	267956
22mm	Flat surface	Resistance type	Orange, AC/DC 380V LED, IP65	ND16-22B/2C 380V ORG	268768
22mm	Flat surface	Resistance type	White, AC/DC 380V LED, IP65	ND16-22B/2C 380V WHT	268767
22mm	Flat surface	Resistance type	Red, AC/DC 380V LED, IP65	ND16-22B/2C 380V RED	268763
22mm	Flat surface	Resistance type	Green, AC/DC 380V LED, IP65	ND16-22B/2C 380V GRN	268765
22mm	Flat surface	Resistance type	Blue, AC/DC 380V LED, IP65	ND16-22B/2C 380V BLU	268766
22mm	Flat surface	Resistance type	Yellow, AC/DC 380V LED, IP65	ND16-22B/2C 380V YEL	268764
22mm	Flat surface	Resistance type	Orange, AC/DC 400V LED, IP65	ND16-22B/2C 400V ORG	268825
22mm	Flat surface	Resistance type	White, AC/DC 400V LED, IP65	ND16-22B/2C 400V WHT	268824
22mm	Flat surface	Resistance type	Red, AC/DC 400V LED, IP65	ND16-22B/2C 400V RED	268820
22mm	Flat surface	Resistance type	Green, AC/DC 400V LED, IP65	ND16-22B/2C 400V GRN	268822
22mm	Flat surface	Resistance type	Blue, AC/DC 400V LED, IP65	ND16-22B/2C 400V BLU	268823
22mm	Flat surface	Resistance type	Yellow, AC/DC 400V LED, IP65	ND16-22B/2C 400V YEL	268821
22mm	Flat surface	Resistance type	Orange, AC/DC 48V LED, IP65	ND16-22B/2C 48V ORG	267973
22mm	Flat surface	Resistance type	White, AC/DC 48V LED, IP65	ND16-22B/2C 48V WHT	267972
22mm	Flat surface	Resistance type	Red, AC/DC 48V LED, IP65	ND16-22B/2C 48V RED	267968
22mm	Flat surface	Resistance type	Green, AC/DC 48V LED, IP65	ND16-22B/2C 48V GRN	267970
22mm	Flat surface	Resistance type	Blue, AC/DC 48V LED, IP65	ND16-22B/2C 48V BLU	267971
22mm	Flat surface	Resistance type	Yellow, AC/DC 48V LED, IP65	ND16-22B/2C 48V YEL	267969
22mm	Flat surface	Resistance type	Orange, AC/DC 6V LED, IP65	ND16-22B/2C 6V ORG	267915
22mm	Flat surface	Resistance type	White, AC/DC 6V LED, IP65	ND16-22B/2C 6V WHT	267914
22mm	Flat surface	Resistance type	Red, AC/DC 6V LED, IP65	ND16-22B/2C 6V RED	267910
22mm	Flat surface	Resistance type	Green, AC/DC 6V LED, IP65	ND16-22B/2C 6V GRN	267912
22mm	Flat surface	Resistance type	Blue, AC/DC 6V LED, IP65	ND16-22B/2C 6V BLU	267913
22mm	Flat surface	Resistance type	Yellow, AC/DC 6V LED, IP65	ND16-22B/2C 6V YEL	267911
22mm	Flat surface	Resistance type	Orange, AC/DC 220V LED, anti-interference	ND16-22B/2K2 220V ORG	268659
22mm	Flat surface	Resistance type	White, AC/DC 220V LED, anti-interference	ND16-22B/2K2 220V WHT	268658
22mm	Flat surface	Resistance type	Red, AC/DC 220V LED, anti-interference	ND16-22B/2K2 220V RED	268654
22mm	Flat surface	Resistance type	Green, AC/DC 220V LED, anti-interference	ND16-22B/2K2 220V GRN	268656
22mm	Flat surface	Resistance type	Blue, AC/DC 220V LED, anti-interference	ND16-22B/2K2 220V BLU	268657
22mm	Flat surface	Resistance type	Yellow, AC/DC 220V LED, anti-interference	ND16-22B/2K2 220V YEL	268655
22mm	Flat surface	Resistance and capacitance type	Orange, AC 110V LED	ND16-22B/4 110V ORG	267979
22mm	Flat surface	Resistance and capacitance type	White, AC 110V LED	ND16-22B/4 110V WHT	592621
22mm	Flat surface	Resistance and capacitance type	Red, AC 110V LED	ND16-22B/4 110V RED	592623
22mm	Flat surface	Resistance and capacitance type	Green, AC 110V LED	ND16-22B/4 110V GRN	592625
22mm	Flat surface	Resistance and capacitance type	Blue, AC 110V LED	ND16-22B/4 110V BLU	592622
22mm	Flat surface	Resistance and capacitance type	Yellow, AC 110V LED	ND16-22B/4 110V YEL	592624
22mm	Flat surface	Resistance and capacitance type	Orange, AC 220V LED	ND16-22B/4 220V ORG	593457
22mm	Flat surface	Resistance and capacitance type	White, AC 220V LED	ND16-22B/4 220V WHT	592630
22mm	Flat surface	Resistance and capacitance type	Red, AC 220V LED	ND16-22B/4 220V RED	592626
22mm	Flat surface	Resistance and capacitance type	Green, AC 220V LED	ND16-22B/4 220V GRN	592627
22mm	Flat surface	Resistance and capacitance type	Blue, AC 220V LED	ND16-22B/4 220V BLU	592629
22mm	Flat surface	Resistance and capacitance type	Yellow, AC 220V LED	ND16-22B/4 220V YEL	592628
22mm	Flat surface	Resistance and capacitance type	Orange, AC 230V LED	ND16-22B/4 230V ORG	268669

Diameter	Shape of the head	Internal structure	Color or function	Model Description	Code
22mm	Flat surface	Resistance and capacitance type	White, AC 230V LED	ND16-22B/4 230V WHT	268668
22mm	Flat surface	Resistance and capacitance type	Red, AC 230V LED	ND16-22B/4 230V RED	268664
22mm	Flat surface	Resistance and capacitance type	Green, AC 230V LED	ND16-22B/4 230V GRN	268666
22mm	Flat surface	Resistance and capacitance type	Blue, AC 230V LED	ND16-22B/4 230V BLU	268667
22mm	Flat surface	Resistance and capacitance type	Yellow, AC 230V LED	ND16-22B/4 230V YEL	268665
22mm	Flat surface	Resistance and capacitance type	Orange, AC 240V LED	ND16-22B/4 240V ORG	268711
22mm	Flat surface	Resistance and capacitance type	White, AC 240V LED	ND16-22B/4 240V WHT	593460
22mm	Flat surface	Resistance and capacitance type	Red, AC 240V LED	ND16-22B/4 240V RED	593459
22mm	Flat surface	Resistance and capacitance type	Green, AC 240V LED	ND16-22B/4 240V GRN	593462
22mm	Flat surface	Resistance and capacitance type	Blue, AC 240V LED	ND16-22B/4 240V BLU	593461
22mm	Flat surface	Resistance and capacitance type	Yellow, AC 240V LED	ND16-22B/4 240V YEL	593458
22mm	Flat surface	Resistance and capacitance type	Orange, AC 380V LED	ND16-22B/4 380V ORG	268749
22mm	Flat surface	Resistance and capacitance type	White, AC 380V LED	ND16-22B/4 380V WHT	592635
22mm	Flat surface	Resistance and capacitance type	Red, AC 380V LED	ND16-22B/4 380V RED	592631
22mm	Flat surface	Resistance and capacitance type	Green, AC 380V LED	ND16-22B/4 380V GRN	592632
22mm	Flat surface	Resistance and capacitance type	Blue, AC 380V LED	ND16-22B/4 380V BLU	592634
22mm	Flat surface	Resistance and capacitance type	Yellow, AC 380V LED	ND16-22B/4 380V YEL	592633
22mm	Flat surface	Resistance and capacitance type	Orange, AC 400V LED	ND16-22B/4 400V ORG	268801
22mm	Flat surface	Resistance and capacitance type	White, AC 400V LED	ND16-22B/4 400V WHT	268800
22mm	Flat surface	Resistance and capacitance type	Red, AC 400V LED	ND16-22B/4 400V RED	268796
22mm	Flat surface	Resistance and capacitance type	Green, AC 400V LED	ND16-22B/4 400V GRN	268798
22mm	Flat surface	Resistance and capacitance type	Blue, AC 400V LED	ND16-22B/4 400V BLU	268799
22mm	Flat surface	Resistance and capacitance type	Yellow, AC 400V LED	ND16-22B/4 400V YEL	268797
22mm	Flat surface	Resistance and capacitance type	Orange, AC 110V LED, IP65	ND16-22B/4C 110V ORG	267986
22mm	Flat surface	Resistance and capacitance type	White, AC 110V LED, IP65	ND16-22B/4C 110V WHT	267985
22mm	Flat surface	Resistance and capacitance type	Red, AC 110V LED, IP65	ND16-22B/4C 110V RED	267981
22mm	Flat surface	Resistance and capacitance type	Green, AC 110V LED, IP65	ND16-22B/4C 110V GRN	267983
22mm	Flat surface	Resistance and capacitance type	Blue, AC 110V LED, IP65	ND16-22B/4C 110V BLU	267984
22mm	Flat surface	Resistance and capacitance type	Yellow, AC 110V LED, IP65	ND16-22B/4C 110V YEL	267982
22mm	Flat surface	Resistance and capacitance type	Orange, AC 220V LED, IP65	ND16-22B/4C 220V ORG	268645
22mm	Flat surface	Resistance and capacitance type	White, AC 220V LED, IP65	ND16-22B/4C 220V WHT	268644
22mm	Flat surface	Resistance and capacitance type	Red, AC 220V LED, IP65	ND16-22B/4C 220V RED	268640
22mm	Flat surface	Resistance and capacitance type	Green, AC 220V LED, IP65	ND16-22B/4C 220V GRN	268642
22mm	Flat surface	Resistance and capacitance type	Blue, AC 220V LED, IP65	ND16-22B/4C 220V BLU	268643
22mm	Flat surface	Resistance and capacitance type	Yellow, AC 220V LED, IP65	ND16-22B/4C 220V YEL	268641
22mm	Flat surface	Resistance and capacitance type	Orange, AC 230V LED, IP65	ND16-22B/4C 230V ORG	268676
22mm	Flat surface	Resistance and capacitance type	White, AC 230V LED, IP65	ND16-22B/4C 230V WHT	268675
22mm	Flat surface	Resistance and capacitance type	Red, AC 230V LED, IP65	ND16-22B/4C 230V RED	268671
22mm	Flat surface	Resistance and capacitance type	Green, AC 230V LED, IP65	ND16-22B/4C 230V GRN	268673
22mm	Flat surface	Resistance and capacitance type	Blue, AC 230V LED, IP65	ND16-22B/4C 230V BLU	268674
22mm	Flat surface	Resistance and capacitance type	Yellow, AC 230V LED, IP65	ND16-22B/4C 230V YEL	268672
22mm	Flat surface	Resistance and capacitance type	Orange, AC 240V LED, IP65	ND16-22B/4C 240V ORG	268717
22mm	Flat surface	Resistance and capacitance type	White, AC 240V LED, IP65	ND16-22B/4C 240V WHT	268716
22mm	Flat surface	Resistance and capacitance type	Red, AC 240V LED, IP65	ND16-22B/4C 240V RED	268712

Diameter	Shape of the head	Internal structure	Color or function	Model Description	Code
22mm	Flat surface	Resistance and capacitance type	Green, AC 240V LED, IP65	ND16-22B/4C 240V GRN	268714
22mm	Flat surface	Resistance and capacitance type	Blue, AC 240V LED, IP65	ND16-22B/4C 240V BLU	268715
22mm	Flat surface	Resistance and capacitance type	Yellow, AC 240V LED, IP65	ND16-22B/4C 240V YEL	268713
22mm	Flat surface	Resistance and capacitance type	Orange, AC 380V LED, IP65	ND16-22B/4C 380V ORG	268761
22mm	Flat surface	Resistance and capacitance type	White, AC 380V LED, IP65	ND16-22B/4C 380V WHT	268760
22mm	Flat surface	Resistance and capacitance type	Red, AC 380V LED, IP65	ND16-22B/4C 380V RED	268756
22mm	Flat surface	Resistance and capacitance type	Green, AC 380V LED, IP65	ND16-22B/4C 380V GRN	268758
22mm	Flat surface	Resistance and capacitance type	Blue, AC 380V LED, IP65	ND16-22B/4C 380V BLU	268759
22mm	Flat surface	Resistance and capacitance type	Yellow, AC 380V LED, IP65	ND16-22B/4C 380V YEL	268757
22mm	Flat surface	Resistance and capacitance type	Orange, AC 400V LED, IP65	ND16-22B/4C 400V ORG	268813
22mm	Flat surface	Resistance and capacitance type	White, AC 400V LED, IP65	ND16-22B/4C 400V WHT	268812
22mm	Flat surface	Resistance and capacitance type	Red, AC 400V LED, IP65	ND16-22B/4C 400V RED	268808
22mm	Flat surface	Resistance and capacitance type	Green, AC 400V LED, IP65	ND16-22B/4C 400V GRN	268810
22mm	Flat surface	Resistance and capacitance type	Blue, AC 400V LED, IP65	ND16-22B/4C 400V BLU	268811
22mm	Flat surface	Resistance and capacitance type	Yellow, AC 400V LED, IP65	ND16-22B/4C 400V YEL	268809
22mm	Flat surface	Resistance type, compact	Orange, AC/DC 12V LED	ND16-22BS/2 12V ORG	593402
22mm	Flat surface	Resistance type, compact	White, AC/DC 12V LED	ND16-22BS/2 12V WHT	592891
22mm	Flat surface	Resistance type, compact	Red, AC/DC 12V LED	ND16-22BS/2 12V RED	592893
22mm	Flat surface	Resistance type, compact	Green, AC/DC 12V LED	ND16-22BS/2 12V GRN	592895
22mm	Flat surface	Resistance type, compact	Blue, AC/DC 12V LED	ND16-22BS/2 12V BLU	592892
22mm	Flat surface	Resistance type, compact	Yellow, AC/DC 12V LED	ND16-22BS/2 12V YEL	592894
22mm	Flat surface	Resistance type, compact	Orange, AC/DC 24V LED	ND16-22BS/2 24V ORG	593403
22mm	Flat surface	Resistance type, compact	White, AC/DC 24V LED	ND16-22BS/2 24V WHT	592896
22mm	Flat surface	Resistance type, compact	Red, AC/DC 24V LED	ND16-22BS/2 24V RED	592898
22mm	Flat surface	Resistance type, compact	Green, AC/DC 24V LED	ND16-22BS/2 24V GRN	592900
22mm	Flat surface	Resistance type, compact	Blue, AC/DC 24V LED	ND16-22BS/2 24V BLU	592897
22mm	Flat surface	Resistance type, compact	Yellow, AC/DC 24V LED	ND16-22BS/2 24V YEL	592899
22mm	Flat surface	Resistance type, compact	Orange, AC/DC 36V LED	ND16-22BS/2 36V ORG	267947
22mm	Flat surface	Resistance type, compact	White, AC/DC 36V LED	ND16-22BS/2 36V WHT	593407
22mm	Flat surface	Resistance type, compact	Red, AC/DC 36V LED	ND16-22BS/2 36V RED	593404
22mm	Flat surface	Resistance type, compact	Green, AC/DC 36V LED	ND16-22BS/2 36V GRN	593405
22mm	Flat surface	Resistance type, compact	Blue, AC/DC 36V LED	ND16-22BS/2 36V BLU	593406
22mm	Flat surface	Resistance type, compact	Yellow, AC/DC 36V LED	ND16-22BS/2 36V YEL	267946
22mm	Flat surface	Resistance type, compact	Orange, AC/DC 48V LED	ND16-22BS/2 48V ORG	267965
22mm	Flat surface	Resistance type, compact	White, AC/DC 48V LED	ND16-22BS/2 48V WHT	592901
22mm	Flat surface	Resistance type, compact	Red, AC/DC 48V LED	ND16-22BS/2 48V RED	592903
22mm	Flat surface	Resistance type, compact	Green, AC/DC 48V LED	ND16-22BS/2 48V GRN	592905
22mm	Flat surface	Resistance type, compact	Blue, AC/DC 48V LED	ND16-22BS/2 48V BLU	592902
22mm	Flat surface	Resistance type, compact	Yellow, AC/DC 48V LED	ND16-22BS/2 48V YEL	592904
22mm	Flat surface	Resistance type, compact	Orange, AC/DC 6V LED	ND16-22BS/2 6V ORG	267907
22mm	Flat surface	Resistance type, compact	White, AC/DC 6V LED	ND16-22BS/2 6V WHT	592886
22mm	Flat surface	Resistance type, compact	Red, AC/DC 6V LED	ND16-22BS/2 6V RED	592888
22mm	Flat surface	Resistance type, compact	Green, AC/DC 6V LED	ND16-22BS/2 6V GRN	592890
22mm	Flat surface	Resistance type, compact	Blue, AC/DC 6V LED	ND16-22BS/2 6V BLU	592887

Diameter	Shape of the head	Internal structure	Color or function	Model Description	Code
22mm	Flat surface	Resistance type, compact	Yellow, AC/DC 6V LED	ND16-22BS/2 6V YEL	592889
22mm	Flat surface	Resistance type, compact	Orange, AC/DC 12V LED, IP65	ND16-22BS/2C 12V ORG	828226
22mm	Flat surface	Resistance type, compact	White, AC/DC 12V LED, IP65	ND16-22BS/2C 12V WHT	828221
22mm	Flat surface	Resistance type, compact	Red, AC/DC 12V LED, IP65	ND16-22BS/2C 12V RED	828223
22mm	Flat surface	Resistance type, compact	Green, AC/DC 12V LED, IP65	ND16-22BS/2C 12V GRN	828225
22mm	Flat surface	Resistance type, compact	Blue, AC/DC 12V LED, IP65	ND16-22BS/2C 12V BLU	828222
22mm	Flat surface	Resistance type, compact	Yellow, AC/DC 12V LED, IP65	ND16-22BS/2C 12V YEL	828224
22mm	Flat surface	Resistance type, compact	Orange, AC/DC 24V LED, IP65	ND16-22BS/2C 24V ORG	828238
22mm	Flat surface	Resistance type, compact	White, AC/DC 24V LED, IP65	ND16-22BS/2C 24V WHT	828233
22mm	Flat surface	Resistance type, compact	Red, AC/DC 24V LED, IP65	ND16-22BS/2C 24V RED	828235
22mm	Flat surface	Resistance type, compact	Green, AC/DC 24V LED, IP65	ND16-22BS/2C 24V GRN	828237
22mm	Flat surface	Resistance type, compact	Blue, AC/DC 24V LED, IP65	ND16-22BS/2C 24V BLU	828234
22mm	Flat surface	Resistance type, compact	Yellow, AC/DC 24V LED, IP65	ND16-22BS/2C 24V YEL	828236
22mm	Flat surface	Resistance type, compact	Orange, AC/DC 36V LED, IP65	ND16-22BS/2C 36V ORG	267948
22mm	Flat surface	Resistance type, compact	White, AC/DC 36V LED, IP65	ND16-22BS/2C 36V WHT	828245
22mm	Flat surface	Resistance type, compact	Red, AC/DC 36V LED, IP65	ND16-22BS/2C 36V RED	828247
22mm	Flat surface	Resistance type, compact	Green, AC/DC 36V LED, IP65	ND16-22BS/2C 36V GRN	828249
22mm	Flat surface	Resistance type, compact	Blue, AC/DC 36V LED, IP65	ND16-22BS/2C 36V BLU	828246
22mm	Flat surface	Resistance type, compact	Yellow, AC/DC 36V LED, IP65	ND16-22BS/2C 36V YEL	828248
22mm	Flat surface	Resistance type, compact	Orange, AC/DC 48V LED, IP65	ND16-22BS/2C 48V ORG	267966
22mm	Flat surface	Resistance type, compact	White, AC/DC 48V LED, IP65	ND16-22BS/2C 48V WHT	828255
22mm	Flat surface	Resistance type, compact	Red, AC/DC 48V LED, IP65	ND16-22BS/2C 48V RED	828257
22mm	Flat surface	Resistance type, compact	Green, AC/DC 48V LED, IP65	ND16-22BS/2C 48V GRN	828259
22mm	Flat surface	Resistance type, compact	Blue, AC/DC 48V LED, IP65	ND16-22BS/2C 48V BLU	828256
22mm	Flat surface	Resistance type, compact	Yellow, AC/DC 48V LED, IP65	ND16-22BS/2C 48V YEL	828258
22mm	Flat surface	Resistance type, compact	Orange, AC/DC 6V LED, IP65	ND16-22BS/2C 6V ORG	267908
22mm	Flat surface	Resistance type, compact	White, AC/DC 6V LED, IP65	ND16-22BS/2C 6V WHT	828211
22mm	Flat surface	Resistance type, compact	Red, AC/DC 6V LED, IP65	ND16-22BS/2C 6V RED	828213
22mm	Flat surface	Resistance type, compact	Green, AC/DC 6V LED, IP65	ND16-22BS/2C 6V GRN	828215
22mm	Flat surface	Resistance type, compact	Blue, AC/DC 6V LED, IP65	ND16-22BS/2C 6V BLU	828212
22mm	Flat surface	Resistance type, compact	Yellow, AC/DC 6V LED, IP65	ND16-22BS/2C 6V YEL	828214
22mm	Flat surface	Resistance and capacitance type, compact	Orange, AC 110V LED	ND16-22BS/4 110V ORG	267978
22mm	Flat surface	Resistance and capacitance type, compact	White, AC 110V LED	ND16-22BS/4 110V WHT	592681
22mm	Flat surface	Resistance and capacitance type, compact	Red, AC 110V LED	ND16-22BS/4 110V RED	592683
22mm	Flat surface	Resistance and capacitance type, compact	Green, AC 110V LED	ND16-22BS/4 110V GRN	592685
22mm	Flat surface	Resistance and capacitance type, compact	Blue, AC 110V LED	ND16-22BS/4 110V BLU	592682
22mm	Flat surface	Resistance and capacitance type, compact	Yellow, AC 110V LED	ND16-22BS/4 110V YEL	592684
22mm	Flat surface	Resistance and capacitance type, compact	Orange, AC 220V LED	ND16-22BS/4 220V ORG	268638
22mm	Flat surface	Resistance and capacitance type, compact	White, AC 220V LED	ND16-22BS/4 220V WHT	592686
22mm	Flat surface	Resistance and capacitance type, compact	Red, AC 220V LED	ND16-22BS/4 220V RED	592688
22mm	Flat surface	Resistance and capacitance type, compact	Green, AC 220V LED	ND16-22BS/4 220V GRN	592690
22mm	Flat surface	Resistance and capacitance type, compact	Blue, AC 220V LED	ND16-22BS/4 220V BLU	592687
22mm	Flat surface	Resistance and capacitance type, compact	Yellow, AC 220V LED	ND16-22BS/4 220V YEL	592689
22mm	Flat surface	Resistance and capacitance type, compact	Orange, AC 230V LED	ND16-22BS/4 230V ORG	268663

Diameter	Shape of the head	Internal structure	Color or function	Model Description	Code
22mm	Flat surface	Resistance and capacitance type, compact	White, AC 230V LED	ND16-22BS/4 230V WHT	593292
22mm	Flat surface	Resistance and capacitance type, compact	Red, AC 230V LED	ND16-22BS/4 230V RED	593294
22mm	Flat surface	Resistance and capacitance type, compact	Green, AC 230V LED	ND16-22BS/4 230V GRN	593296
22mm	Flat surface	Resistance and capacitance type, compact	Blue, AC 230V LED	ND16-22BS/4 230V BLU	593293
22mm	Flat surface	Resistance and capacitance type, compact	Yellow, AC 230V LED	ND16-22BS/4 230V YEL	593295
22mm	Flat surface	Resistance and capacitance type, compact	Orange, AC 240V LED	ND16-22BS/4 240V ORG	593418
22mm	Flat surface	Resistance and capacitance type, compact	White, AC 240V LED	ND16-22BS/4 240V WHT	593419
22mm	Flat surface	Resistance and capacitance type, compact	Red, AC 240V LED	ND16-22BS/4 240V RED	593414
22mm	Flat surface	Resistance and capacitance type, compact	Green, AC 240V LED	ND16-22BS/4 240V GRN	593415
22mm	Flat surface	Resistance and capacitance type, compact	Blue, AC 240V LED	ND16-22BS/4 240V BLU	593417
22mm	Flat surface	Resistance and capacitance type, compact	Yellow, AC 240V LED	ND16-22BS/4 240V YEL	593416
22mm	Flat surface	Resistance and capacitance type, compact	Orange, AC 380V LED	ND16-22BS/4 380V ORG	268748
22mm	Flat surface	Resistance and capacitance type, compact	White, AC 380V LED	ND16-22BS/4 380V WHT	592691
22mm	Flat surface	Resistance and capacitance type, compact	Red, AC 380V LED	ND16-22BS/4 380V RED	592693
22mm	Flat surface	Resistance and capacitance type, compact	Green, AC 380V LED	ND16-22BS/4 380V GRN	592695
22mm	Flat surface	Resistance and capacitance type, compact	Blue, AC 380V LED	ND16-22BS/4 380V BLU	592692
22mm	Flat surface	Resistance and capacitance type, compact	Yellow, AC 380V LED	ND16-22BS/4 380V YEL	592694
22mm	Flat surface	Resistance and capacitance type, compact	Orange, AC 400V LED	ND16-22BS/4 400V ORG	268795
22mm	Flat surface	Resistance and capacitance type, compact	White, AC 400V LED	ND16-22BS/4 400V WHT	268794
22mm	Flat surface	Resistance and capacitance type, compact	Red, AC 400V LED	ND16-22BS/4 400V RED	268790
22mm	Flat surface	Resistance and capacitance type, compact	Green, AC 400V LED	ND16-22BS/4 400V GRN	268792
22mm	Flat surface	Resistance and capacitance type, compact	Blue, AC 400V LED	ND16-22BS/4 400V BLU	268793
22mm	Flat surface	Resistance and capacitance type, compact	Yellow, AC 400V LED	ND16-22BS/4 400V YEL	268791
22mm	Flat surface	Resistance and capacitance type, compact	Orange, AC 110V LED, IP65	ND16-22BS/4C 110V ORG	267980
22mm	Flat surface	Resistance and capacitance type, compact	White, AC 110V LED, IP65	ND16-22BS/4C 110V WHT	828265
22mm	Flat surface	Resistance and capacitance type, compact	Red, AC 110V LED, IP65	ND16-22BS/4C 110V RED	828267
22mm	Flat surface	Resistance and capacitance type, compact	Green, AC 110V LED, IP65	ND16-22BS/4C 110V GRN	828269
22mm	Flat surface	Resistance and capacitance type, compact	Blue, AC 110V LED, IP65	ND16-22BS/4C 110V BLU	828266
22mm	Flat surface	Resistance and capacitance type, compact	Yellow, AC 110V LED, IP65	ND16-22BS/4C 110V YEL	828268
22mm	Flat surface	Resistance and capacitance type, compact	Orange, AC 220V LED, IP65	ND16-22BS/4C 220V ORG	268639
22mm	Flat surface	Resistance and capacitance type, compact	White, AC 220V LED, IP65	ND16-22BS/4C 220V WHT	828275
22mm	Flat surface	Resistance and capacitance type, compact	Red, AC 220V LED, IP65	ND16-22BS/4C 220V RED	828277
22mm	Flat surface	Resistance and capacitance type, compact	Green, AC 220V LED, IP65	ND16-22BS/4C 220V GRN	828279
22mm	Flat surface	Resistance and capacitance type, compact	Blue, AC 220V LED, IP65	ND16-22BS/4C 220V BLU	828276
22mm	Flat surface	Resistance and capacitance type, compact	Yellow, AC 220V LED, IP65	ND16-22BS/4C 220V YEL	828278
22mm	Flat surface	Resistance and capacitance type, compact	Orange, AC 230V LED, IP65	ND16-22BS/4C 230V ORG	268670
22mm	Flat surface	Resistance and capacitance type, compact	White, AC 230V LED, IP65	ND16-22BS/4C 230V WHT	828285
22mm	Flat surface	Resistance and capacitance type, compact	Red, AC 230V LED, IP65	ND16-22BS/4C 230V RED	828287
22mm	Flat surface	Resistance and capacitance type, compact	Green, AC 230V LED, IP65	ND16-22BS/4C 230V GRN	828289
22mm	Flat surface	Resistance and capacitance type, compact	Blue, AC 230V LED, IP65	ND16-22BS/4C 230V BLU	828286
22mm	Flat surface	Resistance and capacitance type, compact	Yellow, AC 230V LED, IP65	ND16-22BS/4C 230V YEL	828288
22mm	Flat surface	Resistance and capacitance type, compact	Orange, AC 240V LED, IP65	ND16-22BS/4C 240V ORG	828300
22mm	Flat surface	Resistance and capacitance type, compact	White, AC 240V LED, IP65	ND16-22BS/4C 240V WHT	828295
22mm	Flat surface	Resistance and capacitance type, compact	Red, AC 240V LED, IP65	ND16-22BS/4C 240V RED	828297

Diameter	Shape of the head	Internal structure	Color or function	Model Description	Code
22mm	Flat surface	Resistance and capacitance type, compact	Green, AC 240V LED, IP65	ND16-22BS/4C 240V GRN	828299
22mm	Flat surface	Resistance and capacitance type, compact	Blue, AC 240V LED, IP65	ND16-22BS/4C 240V BLU	828296
22mm	Flat surface	Resistance and capacitance type, compact	Yellow, AC 240V LED, IP65	ND16-22BS/4C 240V YEL	828298
22mm	Flat surface	Resistance and capacitance type, compact	Orange, AC 380V LED, IP65	ND16-22BS/4C 380V ORG	268755
22mm	Flat surface	Resistance and capacitance type, compact	White, AC 380V LED, IP65	ND16-22BS/4C 380V WHT	828307
22mm	Flat surface	Resistance and capacitance type, compact	Red, AC 380V LED, IP65	ND16-22BS/4C 380V RED	828309
22mm	Flat surface	Resistance and capacitance type, compact	Green, AC 380V LED, IP65	ND16-22BS/4C 380V GRN	828311
22mm	Flat surface	Resistance and capacitance type, compact	Blue, AC 380V LED, IP65	ND16-22BS/4C 380V BLU	828308
22mm	Flat surface	Resistance and capacitance type, compact	Yellow, AC 380V LED, IP65	ND16-22BS/4C 380V YEL	828310
22mm	Flat surface	Resistance and capacitance type, compact	Orange, AC 400V LED, IP65	ND16-22BS/4C 400V ORG	268807
22mm	Flat surface	Resistance and capacitance type, compact	White, AC 400V LED, IP65	ND16-22BS/4C 400V WHT	268806
22mm	Flat surface	Resistance and capacitance type, compact	Red, AC 400V LED, IP65	ND16-22BS/4C 400V RED	268802
22mm	Flat surface	Resistance and capacitance type, compact	Green, AC 400V LED, IP65	ND16-22BS/4C 400V GRN	268804
22mm	Flat surface	Resistance and capacitance type, compact	Blue, AC 400V LED, IP65	ND16-22BS/4C 400V BLU	268805
22mm	Flat surface	Resistance and capacitance type, compact	Yellow, AC 400V LED, IP65	ND16-22BS/4C 400V YEL	268803
22mm	Curved surface, with ripple	Resistance type	Orange, AC/DC 110V LED	ND16-22C/2 110V ORG	593442
22mm	Curved surface, with ripple	Resistance type	White, AC/DC 110V LED	ND16-22C/2 110V WHT	592816
22mm	Curved surface, with ripple	Resistance type	Red, AC/DC 110V LED	ND16-22C/2 110V RED	592818
22mm	Curved surface, with ripple	Resistance type	Green, AC/DC 110V LED	ND16-22C/2 110V GRN	592820
22mm	Curved surface, with ripple	Resistance type	Blue, AC/DC 110V LED	ND16-22C/2 110V BLU	592817
22mm	Curved surface, with ripple	Resistance type	Yellow, AC/DC 110V LED	ND16-22C/2 110V YEL	592819
22mm	Curved surface, with ripple	Resistance type	White, AC/DC 12V LED	ND16-22C/2 12V WHT	592801
22mm	Curved surface, with ripple	Resistance type	Red, AC/DC 12V LED	ND16-22C/2 12V RED	592803
22mm	Curved surface, with ripple	Resistance type	Green, AC/DC 12V LED	ND16-22C/2 12V GRN	592805
22mm	Curved surface, with ripple	Resistance type	Blue, AC/DC 12V LED	ND16-22C/2 12V BLU	592802
22mm	Curved surface, with ripple	Resistance type	Yellow, AC/DC 12V LED	ND16-22C/2 12V YEL	592804
22mm	Curved surface, with ripple	Resistance type	White, AC/DC 220V LED	ND16-22C/2 220V WHT	592821
22mm	Curved surface, with ripple	Resistance type	Red, AC/DC 220V LED	ND16-22C/2 220V RED	592823
22mm	Curved surface, with ripple	Resistance type	Green, AC/DC 220V LED	ND16-22C/2 220V GRN	592825
22mm	Curved surface, with ripple	Resistance type	Blue, AC/DC 220V LED	ND16-22C/2 220V BLU	592822
22mm	Curved surface, with ripple	Resistance type	Yellow, AC/DC 220V LED	ND16-22C/2 220V YEL	592824
22mm	Curved surface, with ripple	Resistance type	White, AC/DC 230V LED	ND16-22C/2 230V WHT	593446
22mm	Curved surface, with ripple	Resistance type	Red, AC/DC 230V LED	ND16-22C/2 230V RED	593443
22mm	Curved surface, with ripple	Resistance type	Green, AC/DC 230V LED	ND16-22C/2 230V GRN	593261
22mm	Curved surface, with ripple	Resistance type	Blue, AC/DC 230V LED	ND16-22C/2 230V BLU	593445
22mm	Curved surface, with ripple	Resistance type	Yellow, AC/DC 230V LED	ND16-22C/2 230V YEL	593444
22mm	Curved surface, with ripple	Resistance type	White, AC/DC 240V LED	ND16-22C/2 240V WHT	593908
22mm	Curved surface, with ripple	Resistance type	Red, AC/DC 240V LED	ND16-22C/2 240V RED	593727
22mm	Curved surface, with ripple	Resistance type	Green, AC/DC 240V LED	ND16-22C/2 240V GRN	593725
22mm	Curved surface, with ripple	Resistance type	Blue, AC/DC 240V LED	ND16-22C/2 240V BLU	593906
22mm	Curved surface, with ripple	Resistance type	Yellow, AC/DC 240V LED	ND16-22C/2 240V YEL	593907
22mm	Curved surface, with ripple	Resistance type	White, AC/DC 24V LED	ND16-22C/2 24V WHT	592806
22mm	Curved surface, with ripple	Resistance type	Red, AC/DC 24V LED	ND16-22C/2 24V RED	592808
22mm	Curved surface, with ripple	Resistance type	Green, AC/DC 24V LED	ND16-22C/2 24V GRN	592810

Diameter	Shape of the head	Internal structure	Color or function	Model Description	Code
22mm	Curved surface, with ripple	Resistance type	Blue, AC/DC 24V LED	ND16-22C/2 24V BLU	592807
22mm	Curved surface, with ripple	Resistance type	Yellow, AC/DC 24V LED	ND16-22C/2 24V YEL	592809
22mm	Curved surface, with ripple	Resistance type	White, AC/DC 380V LED	ND16-22C/2 380V WHT	592826
22mm	Curved surface, with ripple	Resistance type	Red, AC/DC 380V LED	ND16-22C/2 380V RED	592828
22mm	Curved surface, with ripple	Resistance type	Green, AC/DC 380V LED	ND16-22C/2 380V GRN	592830
22mm	Curved surface, with ripple	Resistance type	Blue, AC/DC 380V LED	ND16-22C/2 380V BLU	592827
22mm	Curved surface, with ripple	Resistance type	Yellow, AC/DC 380V LED	ND16-22C/2 380V YEL	592829
22mm	Curved surface, with ripple	Resistance type	White, AC/DC 48V LED	ND16-22C/2 48V WHT	592811
22mm	Curved surface, with ripple	Resistance type	Red, AC/DC 48V LED	ND16-22C/2 48V RED	592813
22mm	Curved surface, with ripple	Resistance type	Green, AC/DC 48V LED	ND16-22C/2 48V GRN	592815
22mm	Curved surface, with ripple	Resistance type	Blue, AC/DC 48V LED	ND16-22C/2 48V BLU	592812
22mm	Curved surface, with ripple	Resistance type	Yellow, AC/DC 48V LED	ND16-22C/2 48V YEL	592814
22mm	Curved surface, with ripple	Resistance type	White, AC/DC 6V LED	ND16-22C/2 6V WHT	592796
22mm	Curved surface, with ripple	Resistance type	Red, AC/DC 6V LED	ND16-22C/2 6V RED	592798
22mm	Curved surface, with ripple	Resistance type	Green, AC/DC 6V LED	ND16-22C/2 6V GRN	592800
22mm	Curved surface, with ripple	Resistance type	Blue, AC/DC 6V LED	ND16-22C/2 6V BLU	592797
22mm	Curved surface, with ripple	Resistance type	Yellow, AC/DC 6V LED	ND16-22C/2 6V YEL	592799
22mm	Curved surface, with ripple	Resistance and capacitance type	White, AC 110V LED	ND16-22C/4 110V WHT	592640
22mm	Curved surface, with ripple	Resistance and capacitance type	Red, AC 110V LED	ND16-22C/4 110V RED	592636
22mm	Curved surface, with ripple	Resistance and capacitance type	Green, AC 110V LED	ND16-22C/4 110V GRN	592638
22mm	Curved surface, with ripple	Resistance and capacitance type	Blue, AC 110V LED	ND16-22C/4 110V BLU	592639
22mm	Curved surface, with ripple	Resistance and capacitance type	Yellow, AC 110V LED	ND16-22C/4 110V YEL	592637
22mm	Curved surface, with ripple	Resistance and capacitance type	Orange, AC 220V LED	ND16-22C/4 220V ORG	593730
22mm	Curved surface, with ripple	Resistance and capacitance type	White, AC 220V LED	ND16-22C/4 220V WHT	592645
22mm	Curved surface, with ripple	Resistance and capacitance type	Red, AC 220V LED	ND16-22C/4 220V RED	592641
22mm	Curved surface, with ripple	Resistance and capacitance type	Green, AC 220V LED	ND16-22C/4 220V GRN	592643
22mm	Curved surface, with ripple	Resistance and capacitance type	Blue, AC 220V LED	ND16-22C/4 220V BLU	592644
22mm	Curved surface, with ripple	Resistance and capacitance type	Yellow, AC 220V LED	ND16-22C/4 220V YEL	592642
22mm	Curved surface, with ripple	Resistance and capacitance type	White, AC 230V LED	ND16-22C/4 230V WHT	593262
22mm	Curved surface, with ripple	Resistance and capacitance type	Red, AC 230V LED	ND16-22C/4 230V RED	593263
22mm	Curved surface, with ripple	Resistance and capacitance type	Green, AC 230V LED	ND16-22C/4 230V GRN	593266
22mm	Curved surface, with ripple	Resistance and capacitance type	Blue, AC 230V LED	ND16-22C/4 230V BLU	593265
22mm	Curved surface, with ripple	Resistance and capacitance type	Yellow, AC 230V LED	ND16-22C/4 230V YEL	593264
22mm	Curved surface, with ripple	Resistance and capacitance type	White, AC 380V LED	ND16-22C/4 380V WHT	592650
22mm	Curved surface, with ripple	Resistance and capacitance type	Red, AC 380V LED	ND16-22C/4 380V RED	592646
22mm	Curved surface, with ripple	Resistance and capacitance type	Green, AC 380V LED	ND16-22C/4 380V GRN	592648
22mm	Curved surface, with ripple	Resistance and capacitance type	Blue, AC 380V LED	ND16-22C/4 380V BLU	592649
22mm	Curved surface, with ripple	Resistance and capacitance type	Yellow, AC 380V LED	ND16-22C/4 380V YEL	592647
22mm	Curved surface, with ripple	Resistance type, compact	Orange, AC/DC 12V LED	ND16-22CS/2 12V ORG	593408
22mm	Curved surface, with ripple	Resistance type, compact	White, AC/DC 12V LED	ND16-22CS/2 12V WHT	592911
22mm	Curved surface, with ripple	Resistance type, compact	Red, AC/DC 12V LED	ND16-22CS/2 12V RED	592913
22mm	Curved surface, with ripple	Resistance type, compact	Green, AC/DC 12V LED	ND16-22CS/2 12V GRN	592915
22mm	Curved surface, with ripple	Resistance type, compact	Blue, AC/DC 12V LED	ND16-22CS/2 12V BLU	592912
22mm	Curved surface, with ripple	Resistance type, compact	Yellow, AC/DC 12V LED	ND16-22CS/2 12V YEL	592914

Diameter	Shape of the head	Internal structure	Color or function	Model Description	Code
22mm	Curved surface, with ripple	Resistance type, compact	White, AC/DC 24V LED	ND16-22CS/2 24V WHT	592916
22mm	Curved surface, with ripple	Resistance type, compact	Red, AC/DC 24V LED	ND16-22CS/2 24V RED	592918
22mm	Curved surface, with ripple	Resistance type, compact	Green, AC/DC 24V LED	ND16-22CS/2 24V GRN	592920
22mm	Curved surface, with ripple	Resistance type, compact	Blue, AC/DC 24V LED	ND16-22CS/2 24V BLU	592917
22mm	Curved surface, with ripple	Resistance type, compact	Yellow, AC/DC 24V LED	ND16-22CS/2 24V YEL	592919
22mm	Curved surface, with ripple	Resistance type, compact	Orange, AC/DC 36V LED	ND16-22CS/2 36V ORG	593411
22mm	Curved surface, with ripple	Resistance type, compact	Red, AC/DC 36V LED	ND16-22CS/2 36V RED	593409
22mm	Curved surface, with ripple	Resistance type, compact	Green, AC/DC 36V LED	ND16-22CS/2 36V GRN	593410
22mm	Curved surface, with ripple	Resistance type, compact	White, AC/DC 48V LED	ND16-22CS/2 48V WHT	592921
22mm	Curved surface, with ripple	Resistance type, compact	Red, AC/DC 48V LED	ND16-22CS/2 48V RED	592923
22mm	Curved surface, with ripple	Resistance type, compact	Green, AC/DC 48V LED	ND16-22CS/2 48V GRN	592925
22mm	Curved surface, with ripple	Resistance type, compact	Blue, AC/DC 48V LED	ND16-22CS/2 48V BLU	592922
22mm	Curved surface, with ripple	Resistance type, compact	Yellow, AC/DC 48V LED	ND16-22CS/2 48V YEL	592924
22mm	Curved surface, with ripple	Resistance type, compact	White, AC/DC 6V LED	ND16-22CS/2 6V WHT	592906
22mm	Curved surface, with ripple	Resistance type, compact	Red, AC/DC 6V LED	ND16-22CS/2 6V RED	592908
22mm	Curved surface, with ripple	Resistance type, compact	Green, AC/DC 6V LED	ND16-22CS/2 6V GRN	592910
22mm	Curved surface, with ripple	Resistance type, compact	Blue, AC/DC 6V LED	ND16-22CS/2 6V BLU	592907
22mm	Curved surface, with ripple	Resistance type, compact	Yellow, AC/DC 6V LED	ND16-22CS/2 6V YEL	592909
22mm	Curved surface, with ripple	Resistance and capacitance type, compact	White, AC 110V LED	ND16-22CS/4 110V WHT	592696
22mm	Curved surface, with ripple	Resistance and capacitance type, compact	Red, AC 110V LED	ND16-22CS/4 110V RED	592698
22mm	Curved surface, with ripple	Resistance and capacitance type, compact	Green, AC 110V LED	ND16-22CS/4 110V GRN	592700
22mm	Curved surface, with ripple	Resistance and capacitance type, compact	Blue, AC 110V LED	ND16-22CS/4 110V BLU	592697
22mm	Curved surface, with ripple	Resistance and capacitance type, compact	Yellow, AC 110V LED	ND16-22CS/4 110V YEL	592699
22mm	Curved surface, with ripple	Resistance and capacitance type, compact	White, AC 220V LED	ND16-22CS/4 220V WHT	592701
22mm	Curved surface, with ripple	Resistance and capacitance type, compact	Red, AC 220V LED	ND16-22CS/4 220V RED	592703
22mm	Curved surface, with ripple	Resistance and capacitance type, compact	Green, AC 220V LED	ND16-22CS/4 220V GRN	592705
22mm	Curved surface, with ripple	Resistance and capacitance type, compact	Blue, AC 220V LED	ND16-22CS/4 220V BLU	592702
22mm	Curved surface, with ripple	Resistance and capacitance type, compact	Yellow, AC 220V LED	ND16-22CS/4 220V YEL	592704
22mm	Curved surface, with ripple	Resistance and capacitance type, compact	White, AC 230V LED	ND16-22CS/4 230V WHT	828378
22mm	Curved surface, with ripple	Resistance and capacitance type, compact	Red, AC 230V LED	ND16-22CS/4 230V RED	593420
22mm	Curved surface, with ripple	Resistance and capacitance type, compact	Green, AC 230V LED	ND16-22CS/4 230V GRN	593421
22mm	Curved surface, with ripple	Resistance and capacitance type, compact	Blue, AC 230V LED	ND16-22CS/4 230V BLU	593912
22mm	Curved surface, with ripple	Resistance and capacitance type, compact	Yellow, AC 230V LED	ND16-22CS/4 230V YEL	593422
22mm	Curved surface, with ripple	Resistance and capacitance type, compact	Red, AC 240V LED	ND16-22CS/4 240V RED	593423
22mm	Curved surface, with ripple	Resistance and capacitance type, compact	Green, AC 240V LED	ND16-22CS/4 240V GRN	593424
22mm	Curved surface, with ripple	Resistance and capacitance type, compact	Blue, AC 240V LED	ND16-22CS/4 240V BLU	113416
22mm	Curved surface, with ripple	Resistance and capacitance type, compact	Yellow, AC 240V LED	ND16-22CS/4 240V YEL	593425
22mm	Curved surface, with ripple	Resistance and capacitance type, compact	White, AC 380V LED	ND16-22CS/4 380V WHT	592706
22mm	Curved surface, with ripple	Resistance and capacitance type, compact	Red, AC 380V LED	ND16-22CS/4 380V RED	592708
22mm	Curved surface, with ripple	Resistance and capacitance type, compact	Green, AC 380V LED	ND16-22CS/4 380V GRN	592710
22mm	Curved surface, with ripple	Resistance and capacitance type, compact	Blue, AC 380V LED	ND16-22CS/4 380V BLU	592707
22mm	Curved surface, with ripple	Resistance and capacitance type, compact	Yellow, AC 380V LED	ND16-22CS/4 380V YEL	592709
22mm	Curved surface, with ripple	Resistance and capacitance type, compact	Red, AC 400V LED	ND16-22CS/4 400V RED	593728
22mm	Curved surface, with ripple	Resistance and capacitance type, compact	Green, AC 400V LED	ND16-22CS/4 400V GRN	593729

Diameter	Shape of the head	Internal structure	Color or function	Model Description	Code
22mm	Curved surface	Resistance type	Orange, AC/DC 110V LED	ND16-22D/2 110V ORG	267976
22mm	Curved surface	Resistance type	White, AC/DC 110V LED	ND16-22D/2 110V WHT	592851
22mm	Curved surface	Resistance type	Red, AC/DC 110V LED	ND16-22D/2 110V RED	592853
22mm	Curved surface	Resistance type	Green, AC/DC 110V LED	ND16-22D/2 110V GRN	592855
22mm	Curved surface	Resistance type	Blue, AC/DC 110V LED	ND16-22D/2 110V BLU	592852
22mm	Curved surface	Resistance type	Yellow, AC/DC 110V LED	ND16-22D/2 110V YEL	592854
22mm	Curved surface	Resistance type	Orange, AC/DC 12V LED	ND16-22D/2 12V ORG	267916
22mm	Curved surface	Resistance type	White, AC/DC 12V LED	ND16-22D/2 12V WHT	592836
22mm	Curved surface	Resistance type	Red, AC/DC 12V LED	ND16-22D/2 12V RED	592838
22mm	Curved surface	Resistance type	Green, AC/DC 12V LED	ND16-22D/2 12V GRN	592840
22mm	Curved surface	Resistance type	Blue, AC/DC 12V LED	ND16-22D/2 12V BLU	592837
22mm	Curved surface	Resistance type	Yellow, AC/DC 12V LED	ND16-22D/2 12V YEL	592839
22mm	Curved surface	Resistance type	Orange, AC/DC 220V LED	ND16-22D/2 220V ORG	268636
22mm	Curved surface	Resistance type	White, AC/DC 220V LED	ND16-22D/2 220V WHT	592856
22mm	Curved surface	Resistance type	Red, AC/DC 220V LED	ND16-22D/2 220V RED	592858
22mm	Curved surface	Resistance type	Green, AC/DC 220V LED	ND16-22D/2 220V GRN	592860
22mm	Curved surface	Resistance type	Blue, AC/DC 220V LED	ND16-22D/2 220V BLU	592857
22mm	Curved surface	Resistance type	Yellow, AC/DC 220V LED	ND16-22D/2 220V YEL	592859
22mm	Curved surface	Resistance type	Orange, AC/DC 230V LED	ND16-22D/2 230V ORG	268661
22mm	Curved surface	Resistance type	White, AC/DC 230V LED	ND16-22D/2 230V WHT	593073
22mm	Curved surface	Resistance type	Red, AC/DC 230V LED	ND16-22D/2 230V RED	593075
22mm	Curved surface	Resistance type	Green, AC/DC 230V LED	ND16-22D/2 230V GRN	593077
22mm	Curved surface	Resistance type	Blue, AC/DC 230V LED	ND16-22D/2 230V BLU	593074
22mm	Curved surface	Resistance type	Yellow, AC/DC 230V LED	ND16-22D/2 230V YEL	593076
22mm	Curved surface	Resistance type	Orange, AC/DC 240V LED	ND16-22D/2 240V ORG	593273
22mm	Curved surface	Resistance type	White, AC/DC 240V LED	ND16-22D/2 240V WHT	268704
22mm	Curved surface	Resistance type	Red, AC/DC 240V LED	ND16-22D/2 240V RED	828383
22mm	Curved surface	Resistance type	Green, AC/DC 240V LED	ND16-22D/2 240V GRN	268702
22mm	Curved surface	Resistance type	Blue, AC/DC 240V LED	ND16-22D/2 240V BLU	268703
22mm	Curved surface	Resistance type	Yellow, AC/DC 240V LED	ND16-22D/2 240V YEL	268701
22mm	Curved surface	Resistance type	Orange, AC/DC 24V LED	ND16-22D/2 24V ORG	267925
22mm	Curved surface	Resistance type	White, AC/DC 24V LED	ND16-22D/2 24V WHT	592841
22mm	Curved surface	Resistance type	Red, AC/DC 24V LED	ND16-22D/2 24V RED	592843
22mm	Curved surface	Resistance type	Green, AC/DC 24V LED	ND16-22D/2 24V GRN	592845
22mm	Curved surface	Resistance type	Blue, AC/DC 24V LED	ND16-22D/2 24V BLU	592842
22mm	Curved surface	Resistance type	Yellow, AC/DC 24V LED	ND16-22D/2 24V YEL	592844
22mm	Curved surface	Resistance type	Orange, AC/DC 36V LED	ND16-22D/2 36V ORG	267939
22mm	Curved surface	Resistance type	White, AC/DC 36V LED	ND16-22D/2 36V WHT	267938
22mm	Curved surface	Resistance type	Red, AC/DC 36V LED	ND16-22D/2 36V RED	267934
22mm	Curved surface	Resistance type	Green, AC/DC 36V LED	ND16-22D/2 36V GRN	267936
22mm	Curved surface	Resistance type	Blue, AC/DC 36V LED	ND16-22D/2 36V BLU	267937
22mm	Curved surface	Resistance type	Yellow, AC/DC 36V LED	ND16-22D/2 36V YEL	267935
22mm	Curved surface	Resistance type	Orange, AC/DC 380V LED	ND16-22D/2 380V ORG	268746
22mm	Curved surface	Resistance type	White, AC/DC 380V LED	ND16-22D/2 380V WHT	592861

Diameter	Shape of the head	Internal structure	Color or function	Model Description	Code
22mm	Curved surface	Resistance type	Red, AC/DC 380V LED	ND16-22D/2 380V RED	592863
22mm	Curved surface	Resistance type	Green, AC/DC 380V LED	ND16-22D/2 380V GRN	592865
22mm	Curved surface	Resistance type	Blue, AC/DC 380V LED	ND16-22D/2 380V BLU	592862
22mm	Curved surface	Resistance type	Yellow, AC/DC 380V LED	ND16-22D/2 380V YEL	592864
22mm	Curved surface	Resistance type	Orange, AC/DC 400V LED	ND16-22D/2 400V ORG	268788
22mm	Curved surface	Resistance type	White, AC/DC 400V LED	ND16-22D/2 400V WHT	593448
22mm	Curved surface	Resistance type	Red, AC/DC 400V LED	ND16-22D/2 400V RED	593447
22mm	Curved surface	Resistance type	Green, AC/DC 400V LED	ND16-22D/2 400V GRN	593449
22mm	Curved surface	Resistance type	Blue, AC/DC 400V LED	ND16-22D/2 400V BLU	593451
22mm	Curved surface	Resistance type	Yellow, AC/DC 400V LED	ND16-22D/2 400V YEL	593450
22mm	Curved surface	Resistance type	Orange, AC/DC 48V LED	ND16-22D/2 48V ORG	267963
22mm	Curved surface	Resistance type	White, AC/DC 48V LED	ND16-22D/2 48V WHT	592846
22mm	Curved surface	Resistance type	Red, AC/DC 48V LED	ND16-22D/2 48V RED	592848
22mm	Curved surface	Resistance type	Green, AC/DC 48V LED	ND16-22D/2 48V GRN	592850
22mm	Curved surface	Resistance type	Blue, AC/DC 48V LED	ND16-22D/2 48V BLU	592847
22mm	Curved surface	Resistance type	Yellow, AC/DC 48V LED	ND16-22D/2 48V YEL	592849
22mm	Curved surface	Resistance type	Orange, AC/DC 6V LED	ND16-22D/2 6V ORG	267905
22mm	Curved surface	Resistance type	White, AC/DC 6V LED	ND16-22D/2 6V WHT	592831
22mm	Curved surface	Resistance type	Red, AC/DC 6V LED	ND16-22D/2 6V RED	592833
22mm	Curved surface	Resistance type	Green, AC/DC 6V LED	ND16-22D/2 6V GRN	592835
22mm	Curved surface	Resistance type	Blue, AC/DC 6V LED	ND16-22D/2 6V BLU	592832
22mm	Curved surface	Resistance type	Yellow, AC/DC 6V LED	ND16-22D/2 6V YEL	592834
22mm	Curved surface	Resistance type	Orange, AC/DC 110V LED, IP65	ND16-22D/2C 110V ORG	267977
22mm	Curved surface	Resistance type	White, AC/DC 110V LED, IP65	ND16-22D/2C 110V WHT	593971
22mm	Curved surface	Resistance type	Red, AC/DC 110V LED, IP65	ND16-22D/2C 110V RED	593973
22mm	Curved surface	Resistance type	Green, AC/DC 110V LED, IP65	ND16-22D/2C 110V GRN	828001
22mm	Curved surface	Resistance type	Blue, AC/DC 110V LED, IP65	ND16-22D/2C 110V BLU	593972
22mm	Curved surface	Resistance type	Yellow, AC/DC 110V LED, IP65	ND16-22D/2C 110V YEL	828000
22mm	Curved surface	Resistance type	Orange, AC/DC 12V LED, IP65	ND16-22D/2C 12V ORG	267917
22mm	Curved surface	Resistance type	White, AC/DC 12V LED, IP65	ND16-22D/2C 12V WHT	593941
22mm	Curved surface	Resistance type	Red, AC/DC 12V LED, IP65	ND16-22D/2C 12V RED	593943
22mm	Curved surface	Resistance type	Green, AC/DC 12V LED, IP65	ND16-22D/2C 12V GRN	593945
22mm	Curved surface	Resistance type	Blue, AC/DC 12V LED, IP65	ND16-22D/2C 12V BLU	593942
22mm	Curved surface	Resistance type	Yellow, AC/DC 12V LED, IP65	ND16-22D/2C 12V YEL	593944
22mm	Curved surface	Resistance type	Orange, AC/DC 220V LED, IP65	ND16-22D/2C 220V ORG	268637
22mm	Curved surface	Resistance type	White, AC/DC 220V LED, IP65	ND16-22D/2C 220V WHT	828007
22mm	Curved surface	Resistance type	Red, AC/DC 220V LED, IP65	ND16-22D/2C 220V RED	828009
22mm	Curved surface	Resistance type	Green, AC/DC 220V LED, IP65	ND16-22D/2C 220V GRN	828011
22mm	Curved surface	Resistance type	Blue, AC/DC 220V LED, IP65	ND16-22D/2C 220V BLU	828008
22mm	Curved surface	Resistance type	Yellow, AC/DC 220V LED, IP65	ND16-22D/2C 220V YEL	828010
22mm	Curved surface	Resistance type	Orange, AC/DC 230V LED, IP65	ND16-22D/2C 230V ORG	268662
22mm	Curved surface	Resistance type	White, AC/DC 230V LED, IP65	ND16-22D/2C 230V WHT	828017
22mm	Curved surface	Resistance type	Red, AC/DC 230V LED, IP65	ND16-22D/2C 230V RED	828019
22mm	Curved surface	Resistance type	Green, AC/DC 230V LED, IP65	ND16-22D/2C 230V GRN	828021

Diameter	Shape of the head	Internal structure	Color or function	Model Description	Code
22mm	Curved surface	Resistance type	Blue, AC/DC 230V LED, IP65	ND16-22D/2C 230V BLU	828018
22mm	Curved surface	Resistance type	Yellow, AC/DC 230V LED, IP65	ND16-22D/2C 230V YEL	828020
22mm	Curved surface	Resistance type	Orange, AC/DC 240V LED, IP65	ND16-22D/2C 240V ORG	828027
22mm	Curved surface	Resistance type	White, AC/DC 240V LED, IP65	ND16-22D/2C 240V WHT	268709
22mm	Curved surface	Resistance type	Red, AC/DC 240V LED, IP65	ND16-22D/2C 240V RED	268705
22mm	Curved surface	Resistance type	Green, AC/DC 240V LED, IP65	ND16-22D/2C 240V GRN	268707
22mm	Curved surface	Resistance type	Blue, AC/DC 240V LED, IP65	ND16-22D/2C 240V BLU	268708
22mm	Curved surface	Resistance type	Yellow, AC/DC 240V LED, IP65	ND16-22D/2C 240V YEL	268706
22mm	Curved surface	Resistance type	White, AC/DC 24V LED, IP65	ND16-22D/2C 24V WHT	593951
22mm	Curved surface	Resistance type	Red, AC/DC 24V LED, IP65	ND16-22D/2C 24V RED	593953
22mm	Curved surface	Resistance type	Green, AC/DC 24V LED, IP65	ND16-22D/2C 24V GRN	593955
22mm	Curved surface	Resistance type	Blue, AC/DC 24V LED, IP65	ND16-22D/2C 24V BLU	593952
22mm	Curved surface	Resistance type	Yellow, AC/DC 24V LED, IP65	ND16-22D/2C 24V YEL	593954
22mm	Curved surface	Resistance type	Orange, AC/DC 36V LED, IP65	ND16-22D/2C 36V ORG	267945
22mm	Curved surface	Resistance type	White, AC/DC 36V LED, IP65	ND16-22D/2C 36V WHT	267944
22mm	Curved surface	Resistance type	Red, AC/DC 36V LED, IP65	ND16-22D/2C 36V RED	267940
22mm	Curved surface	Resistance type	Green, AC/DC 36V LED, IP65	ND16-22D/2C 36V GRN	267942
22mm	Curved surface	Resistance type	Blue, AC/DC 36V LED, IP65	ND16-22D/2C 36V BLU	267943
22mm	Curved surface	Resistance type	Yellow, AC/DC 36V LED, IP65	ND16-22D/2C 36V YEL	267941
22mm	Curved surface	Resistance type	Orange, AC/DC 380V LED, IP65	ND16-22D/2C 380V ORG	268747
22mm	Curved surface	Resistance type	White, AC/DC 380V LED, IP65	ND16-22D/2C 380V WHT	828029
22mm	Curved surface	Resistance type	Red, AC/DC 380V LED, IP65	ND16-22D/2C 380V RED	828031
22mm	Curved surface	Resistance type	Green, AC/DC 380V LED, IP65	ND16-22D/2C 380V GRN	828033
22mm	Curved surface	Resistance type	Blue, AC/DC 380V LED, IP65	ND16-22D/2C 380V BLU	828030
22mm	Curved surface	Resistance type	Yellow, AC/DC 380V LED, IP65	ND16-22D/2C 380V YEL	828032
22mm	Curved surface	Resistance type	Orange, AC/DC 400V LED, IP65	ND16-22D/2C 400V ORG	268789
22mm	Curved surface	Resistance type	White, AC/DC 400V LED, IP65	ND16-22D/2C 400V WHT	828039
22mm	Curved surface	Resistance type	Red, AC/DC 400V LED, IP65	ND16-22D/2C 400V RED	828041
22mm	Curved surface	Resistance type	Green, AC/DC 400V LED, IP65	ND16-22D/2C 400V GRN	828043
22mm	Curved surface	Resistance type	Blue, AC/DC 400V LED, IP65	ND16-22D/2C 400V BLU	828040
22mm	Curved surface	Resistance type	Yellow, AC/DC 400V LED, IP65	ND16-22D/2C 400V YEL	828042
22mm	Curved surface	Resistance type	Orange, AC/DC 48V LED, IP65	ND16-22D/2C 48V ORG	267964
22mm	Curved surface	Resistance type	White, AC/DC 48V LED, IP65	ND16-22D/2C 48V WHT	593961
22mm	Curved surface	Resistance type	Red, AC/DC 48V LED, IP65	ND16-22D/2C 48V RED	593963
22mm	Curved surface	Resistance type	Green, AC/DC 48V LED, IP65	ND16-22D/2C 48V GRN	593965
22mm	Curved surface	Resistance type	Blue, AC/DC 48V LED, IP65	ND16-22D/2C 48V BLU	593962
22mm	Curved surface	Resistance type	Yellow, AC/DC 48V LED, IP65	ND16-22D/2C 48V YEL	593964
22mm	Curved surface	Resistance type	Orange, AC/DC 6V LED, IP65	ND16-22D/2C 6V ORG	267906
22mm	Curved surface	Resistance type	White, AC/DC 6V LED, IP65	ND16-22D/2C 6V WHT	593931
22mm	Curved surface	Resistance type	Red, AC/DC 6V LED, IP65	ND16-22D/2C 6V RED	593933
22mm	Curved surface	Resistance type	Green, AC/DC 6V LED, IP65	ND16-22D/2C 6V GRN	593935
22mm	Curved surface	Resistance type	Blue, AC/DC 6V LED, IP65	ND16-22D/2C 6V BLU	593932
22mm	Curved surface	Resistance type	Yellow, AC/DC 6V LED, IP65	ND16-22D/2C 6V YEL	593934
22mm	Curved surface	Resistance type	Orange, AC/DC 110V LED, anti-interference	ND16-22D/2K2 110V ORG	267998

Diameter	Shape of the head	Internal structure	Color or function	Model Description	Code
22mm	Curved surface	Resistance type	White, AC/DC 110V LED, anti-interference	ND16-22D/2K2 110V WHT	267997
22mm	Curved surface	Resistance type	Red, AC/DC 110V LED, anti-interference	ND16-22D/2K2 110V RED	267993
22mm	Curved surface	Resistance type	Green, AC/DC 110V LED, anti-interference	ND16-22D/2K2 110V GRN	267995
22mm	Curved surface	Resistance type	Blue, AC/DC 110V LED, anti-interference	ND16-22D/2K2 110V BLU	267996
22mm	Curved surface	Resistance type	Yellow, AC/DC 110V LED, anti-interference	ND16-22D/2K2 110V YEL	267994
22mm	Curved surface	Resistance type	Orange, AC/DC 220V LED, anti-interference	ND16-22D/2K2 220V ORG	268652
22mm	Curved surface	Resistance type	White, AC/DC 220V LED, anti-interference	ND16-22D/2K2 220V WHT	593274
22mm	Curved surface	Resistance type	Red, AC/DC 220V LED, anti-interference	ND16-22D/2K2 220V RED	828377
22mm	Curved surface	Resistance type	Green, AC/DC 220V LED, anti-interference	ND16-22D/2K2 220V GRN	593278
22mm	Curved surface	Resistance type	Blue, AC/DC 220V LED, anti-interference	ND16-22D/2K2 220V BLU	593277
22mm	Curved surface	Resistance type	Yellow, AC/DC 220V LED, anti-interference	ND16-22D/2K2 220V YEL	593276
22mm	Curved surface	Resistance type	Orange, AC/DC 230V LED, anti-interference	ND16-22D/2K2 230V ORG	268692
22mm	Curved surface	Resistance type	White, AC/DC 230V LED, anti-interference	ND16-22D/2K2 230V WHT	268691
22mm	Curved surface	Resistance type	Red, AC/DC 230V LED, anti-interference	ND16-22D/2K2 230V RED	268687
22mm	Curved surface	Resistance type	Green, AC/DC 230V LED, anti-interference	ND16-22D/2K2 230V GRN	268689
22mm	Curved surface	Resistance type	Blue, AC/DC 230V LED, anti-interference	ND16-22D/2K2 230V BLU	268690
22mm	Curved surface	Resistance type	Yellow, AC/DC 230V LED, anti-interference	ND16-22D/2K2 230V YEL	268688
22mm	Curved surface	Resistance type	Orange, AC/DC 240V LED, anti-interference	ND16-22D/2K2 240V ORG	268736
22mm	Curved surface	Resistance type	White, AC/DC 240V LED, anti-interference	ND16-22D/2K2 240V WHT	268735
22mm	Curved surface	Resistance type	Red, AC/DC 240V LED, anti-interference	ND16-22D/2K2 240V RED	268731
22mm	Curved surface	Resistance type	Green, AC/DC 240V LED, anti-interference	ND16-22D/2K2 240V GRN	268733
22mm	Curved surface	Resistance type	Blue, AC/DC 240V LED, anti-interference	ND16-22D/2K2 240V BLU	268734
22mm	Curved surface	Resistance type	Yellow, AC/DC 240V LED, anti-interference	ND16-22D/2K2 240V YEL	268732
22mm	Curved surface	Resistance type	Orange, AC/DC 380V LED, anti-interference	ND16-22D/2K2 380V ORG	268774
22mm	Curved surface	Resistance type	White, AC/DC 380V LED, anti-interference	ND16-22D/2K2 380V WHT	268773
22mm	Curved surface	Resistance type	Red, AC/DC 380V LED, anti-interference	ND16-22D/2K2 380V RED	268769
22mm	Curved surface	Resistance type	Green, AC/DC 380V LED, anti-interference	ND16-22D/2K2 380V GRN	268771
22mm	Curved surface	Resistance type	Blue, AC/DC 380V LED, anti-interference	ND16-22D/2K2 380V BLU	268772
22mm	Curved surface	Resistance type	Yellow, AC/DC 380V LED, anti-interference	ND16-22D/2K2 380V YEL	268770
22mm	Curved surface	Resistance type	Orange, AC/DC 400V LED, anti-interference	ND16-22D/2K2 400V ORG	268837
22mm	Curved surface	Resistance type	White, AC/DC 400V LED, anti-interference	ND16-22D/2K2 400V WHT	268836
22mm	Curved surface	Resistance type	Red, AC/DC 400V LED, anti-interference	ND16-22D/2K2 400V RED	268832
22mm	Curved surface	Resistance type	Green, AC/DC 400V LED, anti-interference	ND16-22D/2K2 400V GRN	268834
22mm	Curved surface	Resistance type	Blue, AC/DC 400V LED, anti-interference	ND16-22D/2K2 400V BLU	268835
22mm	Curved surface	Resistance type	Yellow, AC/DC 400V LED, anti-interference	ND16-22D/2K2 400V YEL	268833
22mm	Curved surface	Resistance and capacitance type	Orange, AC 110V LED	ND16-22D/4 110V ORG	267974
22mm	Curved surface	Resistance and capacitance type	White, AC 110V LED	ND16-22D/4 110V WHT	592651
22mm	Curved surface	Resistance and capacitance type	Red, AC 110V LED	ND16-22D/4 110V RED	592655
22mm	Curved surface	Resistance and capacitance type	Green, AC 110V LED	ND16-22D/4 110V GRN	592653
22mm	Curved surface	Resistance and capacitance type	Blue, AC 110V LED	ND16-22D/4 110V BLU	592652
22mm	Curved surface	Resistance and capacitance type	Yellow, AC 110V LED	ND16-22D/4 110V YEL	592654
22mm	Curved surface	Resistance and capacitance type	Orange, AC 220V LED	ND16-22D/4 220V ORG	268634
22mm	Curved surface	Resistance and capacitance type	White, AC 220V LED	ND16-22D/4 220V WHT	592656
22mm	Curved surface	Resistance and capacitance type	Red, AC 220V LED	ND16-22D/4 220V RED	592659

Diameter	Shape of the head	Internal structure	Color or function	Model Description	Code
22mm	Curved surface	Resistance and capacitance type	Green, AC 220V LED	ND16-22D/4 220V GRN	592658
22mm	Curved surface	Resistance and capacitance type	Blue, AC 220V LED	ND16-22D/4 220V BLU	592657
22mm	Curved surface	Resistance and capacitance type	Yellow, AC 220V LED	ND16-22D/4 220V YEL	592660
22mm	Curved surface	Resistance and capacitance type	Orange, AC 230V LED	ND16-22D/4 230V ORG	104751
22mm	Curved surface	Resistance and capacitance type	White, AC 230V LED	ND16-22D/4 230V WHT	593279
22mm	Curved surface	Resistance and capacitance type	Red, AC 230V LED	ND16-22D/4 230V RED	593463
22mm	Curved surface	Resistance and capacitance type	Green, AC 230V LED	ND16-22D/4 230V GRN	593464
22mm	Curved surface	Resistance and capacitance type	Blue, AC 230V LED	ND16-22D/4 230V BLU	593465
22mm	Curved surface	Resistance and capacitance type	Yellow, AC 230V LED	ND16-22D/4 230V YEL	593280
22mm	Curved surface	Resistance and capacitance type	Orange, AC 240V LED	ND16-22D/4 240V ORG	593288
22mm	Curved surface	Resistance and capacitance type	White, AC 240V LED	ND16-22D/4 240V WHT	593726
22mm	Curved surface	Resistance and capacitance type	Red, AC 240V LED	ND16-22D/4 240V RED	593335
22mm	Curved surface	Resistance and capacitance type	Green, AC 240V LED	ND16-22D/4 240V GRN	593334
22mm	Curved surface	Resistance and capacitance type	Blue, AC 240V LED	ND16-22D/4 240V BLU	593289
22mm	Curved surface	Resistance and capacitance type	Yellow, AC 240V LED	ND16-22D/4 240V YEL	268699
22mm	Curved surface	Resistance and capacitance type	Orange, AC 380V LED	ND16-22D/4 380V ORG	268744
22mm	Curved surface	Resistance and capacitance type	White, AC 380V LED	ND16-22D/4 380V WHT	592661
22mm	Curved surface	Resistance and capacitance type	Red, AC 380V LED	ND16-22D/4 380V RED	592664
22mm	Curved surface	Resistance and capacitance type	Green, AC 380V LED	ND16-22D/4 380V GRN	592663
22mm	Curved surface	Resistance and capacitance type	Blue, AC 380V LED	ND16-22D/4 380V BLU	592662
22mm	Curved surface	Resistance and capacitance type	Yellow, AC 380V LED	ND16-22D/4 380V YEL	592665
22mm	Curved surface	Resistance and capacitance type	White, AC 400V LED	ND16-22D/4 400V WHT	828381
22mm	Curved surface	Resistance and capacitance type	Red, AC 400V LED	ND16-22D/4 400V RED	828375
22mm	Curved surface	Resistance and capacitance type	Green, AC 400V LED	ND16-22D/4 400V GRN	828379
22mm	Curved surface	Resistance and capacitance type	Blue, AC 400V LED	ND16-22D/4 400V BLU	828380
22mm	Curved surface	Resistance and capacitance type	Yellow, AC 400V LED	ND16-22D/4 400V YEL	828376
22mm	Curved surface	Resistance and capacitance type	Orange, AC 110V LED, IP65	ND16-22D/4C 110V ORG	267975
22mm	Curved surface	Resistance and capacitance type	White, AC 110V LED, IP65	ND16-22D/4C 110V WHT	828045
22mm	Curved surface	Resistance and capacitance type	Red, AC 110V LED, IP65	ND16-22D/4C 110V RED	828047
22mm	Curved surface	Resistance and capacitance type	Green, AC 110V LED, IP65	ND16-22D/4C 110V GRN	828049
22mm	Curved surface	Resistance and capacitance type	Blue, AC 110V LED, IP65	ND16-22D/4C 110V BLU	828046
22mm	Curved surface	Resistance and capacitance type	Yellow, AC 110V LED, IP65	ND16-22D/4C 110V YEL	828048
22mm	Curved surface	Resistance and capacitance type	Orange, AC 220V LED, IP65	ND16-22D/4C 220V ORG	268635
22mm	Curved surface	Resistance and capacitance type	White, AC 220V LED, IP65	ND16-22D/4C 220V WHT	828055
22mm	Curved surface	Resistance and capacitance type	Red, AC 220V LED, IP65	ND16-22D/4C 220V RED	828057
22mm	Curved surface	Resistance and capacitance type	Green, AC 220V LED, IP65	ND16-22D/4C 220V GRN	828059
22mm	Curved surface	Resistance and capacitance type	Blue, AC 220V LED, IP65	ND16-22D/4C 220V BLU	828056
22mm	Curved surface	Resistance and capacitance type	Yellow, AC 220V LED, IP65	ND16-22D/4C 220V YEL	828058
22mm	Curved surface	Resistance and capacitance type	Orange, AC 230V LED, IP65	ND16-22D/4C 230V ORG	268660
22mm	Curved surface	Resistance and capacitance type	White, AC 230V LED, IP65	ND16-22D/4C 230V WHT	828065
22mm	Curved surface	Resistance and capacitance type	Red, AC 230V LED, IP65	ND16-22D/4C 230V RED	828067
22mm	Curved surface	Resistance and capacitance type	Green, AC 230V LED, IP65	ND16-22D/4C 230V GRN	828069
22mm	Curved surface	Resistance and capacitance type	Blue, AC 230V LED, IP65	ND16-22D/4C 230V BLU	828066
22mm	Curved surface	Resistance and capacitance type	Yellow, AC 230V LED, IP65	ND16-22D/4C 230V YEL	828068

Diameter	Shape of the head	Internal structure	Color or function	Model Description	Code
22mm	Curved surface	Resistance and capacitance type	Orange, AC 240V LED, IP65	ND16-22D/4C 240V ORG	828073
22mm	Curved surface	Resistance and capacitance type	White, AC 240V LED, IP65	ND16-22D/4C 240V WHT	828077
22mm	Curved surface	Resistance and capacitance type	Red, AC 240V LED, IP65	ND16-22D/4C 240V RED	828076
22mm	Curved surface	Resistance and capacitance type	Green, AC 240V LED, IP65	ND16-22D/4C 240V GRN	828075
22mm	Curved surface	Resistance and capacitance type	Blue, AC 240V LED, IP65	ND16-22D/4C 240V BLU	828074
22mm	Curved surface	Resistance and capacitance type	Yellow, AC 240V LED, IP65	ND16-22D/4C 240V YEL	268700
22mm	Curved surface	Resistance and capacitance type	Orange, AC 380V LED, IP65	ND16-22D/4C 380V ORG	268745
22mm	Curved surface	Resistance and capacitance type	White, AC 380V LED, IP65	ND16-22D/4C 380V WHT	828080
22mm	Curved surface	Resistance and capacitance type	Red, AC 380V LED, IP65	ND16-22D/4C 380V RED	828082
22mm	Curved surface	Resistance and capacitance type	Green, AC 380V LED, IP65	ND16-22D/4C 380V GRN	828084
22mm	Curved surface	Resistance and capacitance type	Blue, AC 380V LED, IP65	ND16-22D/4C 380V BLU	828081
22mm	Curved surface	Resistance and capacitance type	Yellow, AC 380V LED, IP65	ND16-22D/4C 380V YEL	828083
22mm	Curved surface	Resistance and capacitance type	Orange, AC 400V LED, IP65	ND16-22D/4C 400V ORG	268787
22mm	Curved surface	Resistance and capacitance type	White, AC 400V LED, IP65	ND16-22D/4C 400V WHT	268786
22mm	Curved surface	Resistance and capacitance type	Red, AC 400V LED, IP65	ND16-22D/4C 400V RED	268782
22mm	Curved surface	Resistance and capacitance type	Green, AC 400V LED, IP65	ND16-22D/4C 400V GRN	268784
22mm	Curved surface	Resistance and capacitance type	Blue, AC 400V LED, IP65	ND16-22D/4C 400V BLU	268785
22mm	Curved surface	Resistance and capacitance type	Yellow, AC 400V LED, IP65	ND16-22D/4C 400V YEL	268783
22mm	Curved surface	Resistance and capacitance type	Orange, AC 110V LED, anti-interference	ND16-22D/4K2 110V ORG	268633
22mm	Curved surface	Resistance and capacitance type	White, AC 110V LED, anti-interference	ND16-22D/4K2 110V WHT	268632
22mm	Curved surface	Resistance and capacitance type	Red, AC 110V LED, anti-interference	ND16-22D/4K2 110V RED	267999
22mm	Curved surface	Resistance and capacitance type	Green, AC 110V LED, anti-interference	ND16-22D/4K2 110V GRN	268630
22mm	Curved surface	Resistance and capacitance type	Blue, AC 110V LED, anti-interference	ND16-22D/4K2 110V BLU	268631
22mm	Curved surface	Resistance and capacitance type	Yellow, AC 110V LED, anti-interference	ND16-22D/4K2 110V YEL	268629
22mm	Curved surface	Resistance and capacitance type	Orange, AC 220V LED, anti-interference	ND16-22D/4K2 220V ORG	268653
22mm	Curved surface	Resistance and capacitance type	White, AC 220V LED, anti-interference	ND16-22D/4K2 220V WHT	146696
22mm	Curved surface	Resistance and capacitance type	Red, AC 220V LED, anti-interference	ND16-22D/4K2 220V RED	146692
22mm	Curved surface	Resistance and capacitance type	Green, AC 220V LED, anti-interference	ND16-22D/4K2 220V GRN	146694
22mm	Curved surface	Resistance and capacitance type	Blue, AC 220V LED, anti-interference	ND16-22D/4K2 220V BLU	146695
22mm	Curved surface	Resistance and capacitance type	Yellow, AC 220V LED, anti-interference	ND16-22D/4K2 220V YEL	146693
22mm	Curved surface	Resistance and capacitance type	Orange, AC 230V LED, anti-interference	ND16-22D/4K2 230V ORG	268698
22mm	Curved surface	Resistance and capacitance type	White, AC 230V LED, anti-interference	ND16-22D/4K2 230V WHT	268697
22mm	Curved surface	Resistance and capacitance type	Red, AC 230V LED, anti-interference	ND16-22D/4K2 230V RED	268693
22mm	Curved surface	Resistance and capacitance type	Green, AC 230V LED, anti-interference	ND16-22D/4K2 230V GRN	268695
22mm	Curved surface	Resistance and capacitance type	Blue, AC 230V LED, anti-interference	ND16-22D/4K2 230V BLU	268696
22mm	Curved surface	Resistance and capacitance type	Yellow, AC 230V LED, anti-interference	ND16-22D/4K2 230V YEL	268694
22mm	Curved surface	Resistance and capacitance type	Orange, AC 240V LED, anti-interference	ND16-22D/4K2 240V ORG	268742
22mm	Curved surface	Resistance and capacitance type	White, AC 240V LED, anti-interference	ND16-22D/4K2 240V WHT	268741
22mm	Curved surface	Resistance and capacitance type	Red, AC 240V LED, anti-interference	ND16-22D/4K2 240V RED	268737
22mm	Curved surface	Resistance and capacitance type	Green, AC 240V LED, anti-interference	ND16-22D/4K2 240V GRN	268739
22mm	Curved surface	Resistance and capacitance type	Blue, AC 240V LED, anti-interference	ND16-22D/4K2 240V BLU	268740
22mm	Curved surface	Resistance and capacitance type	Yellow, AC 240V LED, anti-interference	ND16-22D/4K2 240V YEL	268738
22mm	Curved surface	Resistance and capacitance type	Orange, AC 380V LED, anti-interference	ND16-22D/4K2 380V ORG	268780
22mm	Curved surface	Resistance and capacitance type	White, AC 380V LED, anti-interference	ND16-22D/4K2 380V WHT	268779

Diameter	Shape of the head	Internal structure	Color or function	Model Description	Code
22mm	Curved surface	Resistance and capacitance type	Red, AC 380V LED, anti-interference	ND16-22D/4K2 380V RED	268775
22mm	Curved surface	Resistance and capacitance type	Green, AC 380V LED, anti-interference	ND16-22D/4K2 380V GRN	268777
22mm	Curved surface	Resistance and capacitance type	Blue, AC 380V LED, anti-interference	ND16-22D/4K2 380V BLU	268778
22mm	Curved surface	Resistance and capacitance type	Yellow, AC 380V LED, anti-interference	ND16-22D/4K2 380V YEL	268776
22mm	Curved surface	Resistance and capacitance type	Orange, AC 400V LED, anti-interference	ND16-22D/4K2 400V ORG	268843
22mm	Curved surface	Resistance and capacitance type	White, AC 400V LED, anti-interference	ND16-22D/4K2 400V WHT	268842
22mm	Curved surface	Resistance and capacitance type	Red, AC 400V LED, anti-interference	ND16-22D/4K2 400V RED	268838
22mm	Curved surface	Resistance and capacitance type	Green, AC 400V LED, anti-interference	ND16-22D/4K2 400V GRN	268840
22mm	Curved surface	Resistance and capacitance type	Blue, AC 400V LED, anti-interference	ND16-22D/4K2 400V BLU	268841
22mm	Curved surface	Resistance and capacitance type	Yellow, AC 400V LED, anti-interference	ND16-22D/4K2 400V YEL	268839
22mm	Curved surface	Resistance type, compact	Orange, AC/DC 12V LED	ND16-22DS/2 12V ORG	593412
22mm	Curved surface	Resistance type, compact	White, AC/DC 12V LED	ND16-22DS/2 12V WHT	592931
22mm	Curved surface	Resistance type, compact	Red, AC/DC 12V LED	ND16-22DS/2 12V RED	592933
22mm	Curved surface	Resistance type, compact	Green, AC/DC 12V LED	ND16-22DS/2 12V GRN	592935
22mm	Curved surface	Resistance type, compact	Blue, AC/DC 12V LED	ND16-22DS/2 12V BLU	592932
22mm	Curved surface	Resistance type, compact	Yellow, AC/DC 12V LED	ND16-22DS/2 12V YEL	592934
22mm	Curved surface	Resistance type, compact	Orange, AC/DC 24V LED	ND16-22DS/2 24V ORG	593154
22mm	Curved surface	Resistance type, compact	White, AC/DC 24V LED	ND16-22DS/2 24V WHT	592936
22mm	Curved surface	Resistance type, compact	Red, AC/DC 24V LED	ND16-22DS/2 24V RED	592938
22mm	Curved surface	Resistance type, compact	Green, AC/DC 24V LED	ND16-22DS/2 24V GRN	592940
22mm	Curved surface	Resistance type, compact	Blue, AC/DC 24V LED	ND16-22DS/2 24V BLU	592937
22mm	Curved surface	Resistance type, compact	Yellow, AC/DC 24V LED	ND16-22DS/2 24V YEL	592939
22mm	Curved surface	Resistance type, compact	Orange, AC/DC 36V LED	ND16-22DS/2 36V ORG	267932
22mm	Curved surface	Resistance type, compact	White, AC/DC 36V LED	ND16-22DS/2 36V WHT	593355
22mm	Curved surface	Resistance type, compact	Red, AC/DC 36V LED	ND16-22DS/2 36V RED	593357
22mm	Curved surface	Resistance type, compact	Green, AC/DC 36V LED	ND16-22DS/2 36V GRN	593359
22mm	Curved surface	Resistance type, compact	Blue, AC/DC 36V LED	ND16-22DS/2 36V BLU	593356
22mm	Curved surface	Resistance type, compact	Yellow, AC/DC 36V LED	ND16-22DS/2 36V YEL	593358
22mm	Curved surface	Resistance type, compact	Orange, AC/DC 48V LED	ND16-22DS/2 48V ORG	267961
22mm	Curved surface	Resistance type, compact	White, AC/DC 48V LED	ND16-22DS/2 48V WHT	592941
22mm	Curved surface	Resistance type, compact	Red, AC/DC 48V LED	ND16-22DS/2 48V RED	592943
22mm	Curved surface	Resistance type, compact	Green, AC/DC 48V LED	ND16-22DS/2 48V GRN	592945
22mm	Curved surface	Resistance type, compact	Blue, AC/DC 48V LED	ND16-22DS/2 48V BLU	592942
22mm	Curved surface	Resistance type, compact	Yellow, AC/DC 48V LED	ND16-22DS/2 48V YEL	592944
22mm	Curved surface	Resistance type, compact	Orange, AC/DC 6V LED	ND16-22DS/2 6V ORG	267903
22mm	Curved surface	Resistance type, compact	White, AC/DC 6V LED	ND16-22DS/2 6V WHT	592926
22mm	Curved surface	Resistance type, compact	Red, AC/DC 6V LED	ND16-22DS/2 6V RED	592928
22mm	Curved surface	Resistance type, compact	Green, AC/DC 6V LED	ND16-22DS/2 6V GRN	592930
22mm	Curved surface	Resistance type, compact	Blue, AC/DC 6V LED	ND16-22DS/2 6V BLU	592927
22mm	Curved surface	Resistance type, compact	Yellow, AC/DC 6V LED	ND16-22DS/2 6V YEL	592929
22mm	Curved surface	Resistance type, compact	Orange, AC/DC 12V LED, IP65	ND16-22DS/2C 12V ORG	828105
22mm	Curved surface	Resistance type, compact	White, AC/DC 12V LED, IP65	ND16-22DS/2C 12V WHT	828100
22mm	Curved surface	Resistance type, compact	Red, AC/DC 12V LED, IP65	ND16-22DS/2C 12V RED	828102
22mm	Curved surface	Resistance type, compact	Green, AC/DC 12V LED, IP65	ND16-22DS/2C 12V GRN	828104

Diameter	Shape of the head	Internal structure	Color or function	Model Description	Code
22mm	Curved surface	Resistance type, compact	Blue, AC/DC 12V LED, IP65	ND16-22DS/2C 12V BLU	828101
22mm	Curved surface	Resistance type, compact	Yellow, AC/DC 12V LED, IP65	ND16-22DS/2C 12V YEL	828103
22mm	Curved surface	Resistance type, compact	Orange, AC/DC 24V LED, IP65	ND16-22DS/2C 24V ORG	828117
22mm	Curved surface	Resistance type, compact	White, AC/DC 24V LED, IP65	ND16-22DS/2C 24V WHT	828112
22mm	Curved surface	Resistance type, compact	Red, AC/DC 24V LED, IP65	ND16-22DS/2C 24V RED	828114
22mm	Curved surface	Resistance type, compact	Green, AC/DC 24V LED, IP65	ND16-22DS/2C 24V GRN	828116
22mm	Curved surface	Resistance type, compact	Blue, AC/DC 24V LED, IP65	ND16-22DS/2C 24V BLU	828113
22mm	Curved surface	Resistance type, compact	Yellow, AC/DC 24V LED, IP65	ND16-22DS/2C 24V YEL	828115
22mm	Curved surface	Resistance type, compact	Orange, AC/DC 36V LED, IP65	ND16-22DS/2C 36V ORG	267933
22mm	Curved surface	Resistance type, compact	White, AC/DC 36V LED, IP65	ND16-22DS/2C 36V WHT	828124
22mm	Curved surface	Resistance type, compact	Red, AC/DC 36V LED, IP65	ND16-22DS/2C 36V RED	828126
22mm	Curved surface	Resistance type, compact	Green, AC/DC 36V LED, IP65	ND16-22DS/2C 36V GRN	828128
22mm	Curved surface	Resistance type, compact	Blue, AC/DC 36V LED, IP65	ND16-22DS/2C 36V BLU	828125
22mm	Curved surface	Resistance type, compact	Yellow, AC/DC 36V LED, IP65	ND16-22DS/2C 36V YEL	828127
22mm	Curved surface	Resistance type, compact	Orange, AC/DC 48V LED, IP65	ND16-22DS/2C 48V ORG	267962
22mm	Curved surface	Resistance type, compact	White, AC/DC 48V LED, IP65	ND16-22DS/2C 48V WHT	828129
22mm	Curved surface	Resistance type, compact	Red, AC/DC 48V LED, IP65	ND16-22DS/2C 48V RED	828131
22mm	Curved surface	Resistance type, compact	Green, AC/DC 48V LED, IP65	ND16-22DS/2C 48V GRN	828133
22mm	Curved surface	Resistance type, compact	Blue, AC/DC 48V LED, IP65	ND16-22DS/2C 48V BLU	828130
22mm	Curved surface	Resistance type, compact	Yellow, AC/DC 48V LED, IP65	ND16-22DS/2C 48V YEL	828132
22mm	Curved surface	Resistance type, compact	Orange, AC/DC 6V LED, IP65	ND16-22DS/2C 6V ORG	267904
22mm	Curved surface	Resistance type, compact	White, AC/DC 6V LED, IP65	ND16-22DS/2C 6V WHT	828090
22mm	Curved surface	Resistance type, compact	Red, AC/DC 6V LED, IP65	ND16-22DS/2C 6V RED	828092
22mm	Curved surface	Resistance type, compact	Green, AC/DC 6V LED, IP65	ND16-22DS/2C 6V GRN	828094
22mm	Curved surface	Resistance type, compact	Blue, AC/DC 6V LED, IP65	ND16-22DS/2C 6V BLU	828091
22mm	Curved surface	Resistance type, compact	Yellow, AC/DC 6V LED, IP65	ND16-22DS/2C 6V YEL	828093
22mm	Curved surface	Resistance and capacitance type, compact	Orange, AC 110V LED	ND16-22DS/4 110V ORG	593489
22mm	Curved surface	Resistance and capacitance type, compact	White, AC 110V LED	ND16-22DS/4 110V WHT	592711
22mm	Curved surface	Resistance and capacitance type, compact	Red, AC 110V LED	ND16-22DS/4 110V RED	592713
22mm	Curved surface	Resistance and capacitance type, compact	Green, AC 110V LED	ND16-22DS/4 110V GRN	592715
22mm	Curved surface	Resistance and capacitance type, compact	Blue, AC 110V LED	ND16-22DS/4 110V BLU	592712
22mm	Curved surface	Resistance and capacitance type, compact	Yellow, AC 110V LED	ND16-22DS/4 110V YEL	592714
22mm	Curved surface	Resistance and capacitance type, compact	Orange, AC 220V LED	ND16-22DS/4 220V ORG	593426
22mm	Curved surface	Resistance and capacitance type, compact	White, AC 220V LED	ND16-22DS/4 220V WHT	592716
22mm	Curved surface	Resistance and capacitance type, compact	Red, AC 220V LED	ND16-22DS/4 220V RED	592718
22mm	Curved surface	Resistance and capacitance type, compact	Green, AC 220V LED	ND16-22DS/4 220V GRN	592720
22mm	Curved surface	Resistance and capacitance type, compact	Blue, AC 220V LED	ND16-22DS/4 220V BLU	592717
22mm	Curved surface	Resistance and capacitance type, compact	Yellow, AC 220V LED	ND16-22DS/4 220V YEL	592719
22mm	Curved surface	Resistance and capacitance type, compact	Orange, AC 230V LED	ND16-22DS/4 230V ORG	593072
22mm	Curved surface	Resistance and capacitance type, compact	White, AC 230V LED	ND16-22DS/4 230V WHT	593085
22mm	Curved surface	Resistance and capacitance type, compact	Red, AC 230V LED	ND16-22DS/4 230V RED	593012
22mm	Curved surface	Resistance and capacitance type, compact	Green, AC 230V LED	ND16-22DS/4 230V GRN	593071
22mm	Curved surface	Resistance and capacitance type, compact	Blue, AC 230V LED	ND16-22DS/4 230V BLU	593152
22mm	Curved surface	Resistance and capacitance type, compact	Yellow, AC 230V LED	ND16-22DS/4 230V YEL	593150

Diameter	Shape of the head	Internal structure	Color or function	Model Description	Code
22mm	Curved surface	Resistance and capacitance type, compact	Orange, AC 240V LED	ND16-22DS/4 240V ORG	593151
22mm	Curved surface	Resistance and capacitance type, compact	White, AC 240V LED	ND16-22DS/4 240V WHT	593079
22mm	Curved surface	Resistance and capacitance type, compact	Red, AC 240V LED	ND16-22DS/4 240V RED	593146
22mm	Curved surface	Resistance and capacitance type, compact	Green, AC 240V LED	ND16-22DS/4 240V GRN	593147
22mm	Curved surface	Resistance and capacitance type, compact	Blue, AC 240V LED	ND16-22DS/4 240V BLU	593084
22mm	Curved surface	Resistance and capacitance type, compact	Yellow, AC 240V LED	ND16-22DS/4 240V YEL	593148
22mm	Curved surface	Resistance and capacitance type, compact	Orange, AC 380V LED	ND16-22DS/4 380V ORG	593427
22mm	Curved surface	Resistance and capacitance type, compact	White, AC 380V LED	ND16-22DS/4 380V WHT	592721
22mm	Curved surface	Resistance and capacitance type, compact	Red, AC 380V LED	ND16-22DS/4 380V RED	592723
22mm	Curved surface	Resistance and capacitance type, compact	Green, AC 380V LED	ND16-22DS/4 380V GRN	592725
22mm	Curved surface	Resistance and capacitance type, compact	Blue, AC 380V LED	ND16-22DS/4 380V BLU	592722
22mm	Curved surface	Resistance and capacitance type, compact	Yellow, AC 380V LED	ND16-22DS/4 380V YEL	592724
22mm	Curved surface	Resistance and capacitance type, compact	Orange, AC 400V LED	ND16-22DS/4 400V ORG	593431
22mm	Curved surface	Resistance and capacitance type, compact	White, AC 400V LED	ND16-22DS/4 400V WHT	593430
22mm	Curved surface	Resistance and capacitance type, compact	Red, AC 400V LED	ND16-22DS/4 400V RED	593338
22mm	Curved surface	Resistance and capacitance type, compact	Green, AC 400V LED	ND16-22DS/4 400V GRN	593428
22mm	Curved surface	Resistance and capacitance type, compact	Blue, AC 400V LED	ND16-22DS/4 400V BLU	593342
22mm	Curved surface	Resistance and capacitance type, compact	Yellow, AC 400V LED	ND16-22DS/4 400V YEL	593429
22mm	Curved surface	Resistance and capacitance type, compact	Orange, AC 110V LED, IP65	ND16-22DS/4C 110V ORG	828144
22mm	Curved surface	Resistance and capacitance type, compact	White, AC 110V LED, IP65	ND16-22DS/4C 110V WHT	828139
22mm	Curved surface	Resistance and capacitance type, compact	Red, AC 110V LED, IP65	ND16-22DS/4C 110V RED	828141
22mm	Curved surface	Resistance and capacitance type, compact	Green, AC 110V LED, IP65	ND16-22DS/4C 110V GRN	828143
22mm	Curved surface	Resistance and capacitance type, compact	Blue, AC 110V LED, IP65	ND16-22DS/4C 110V BLU	828140
22mm	Curved surface	Resistance and capacitance type, compact	Yellow, AC 110V LED, IP65	ND16-22DS/4C 110V YEL	828142
22mm	Curved surface	Resistance and capacitance type, compact	Orange, AC 220V LED, IP65	ND16-22DS/4C 220V ORG	828156
22mm	Curved surface	Resistance and capacitance type, compact	White, AC 220V LED, IP65	ND16-22DS/4C 220V WHT	828151
22mm	Curved surface	Resistance and capacitance type, compact	Red, AC 220V LED, IP65	ND16-22DS/4C 220V RED	828153
22mm	Curved surface	Resistance and capacitance type, compact	Green, AC 220V LED, IP65	ND16-22DS/4C 220V GRN	828155
22mm	Curved surface	Resistance and capacitance type, compact	Blue, AC 220V LED, IP65	ND16-22DS/4C 220V BLU	828152
22mm	Curved surface	Resistance and capacitance type, compact	Yellow, AC 220V LED, IP65	ND16-22DS/4C 220V YEL	828154
22mm	Curved surface	Resistance and capacitance type, compact	Orange, AC 230V LED, IP65	ND16-22DS/4C 230V ORG	828168
22mm	Curved surface	Resistance and capacitance type, compact	White, AC 230V LED, IP65	ND16-22DS/4C 230V WHT	828163
22mm	Curved surface	Resistance and capacitance type, compact	Red, AC 230V LED, IP65	ND16-22DS/4C 230V RED	828165
22mm	Curved surface	Resistance and capacitance type, compact	Green, AC 230V LED, IP65	ND16-22DS/4C 230V GRN	828167
22mm	Curved surface	Resistance and capacitance type, compact	Blue, AC 230V LED, IP65	ND16-22DS/4C 230V BLU	828164
22mm	Curved surface	Resistance and capacitance type, compact	Yellow, AC 230V LED, IP65	ND16-22DS/4C 230V YEL	828166
22mm	Curved surface	Resistance and capacitance type, compact	Orange, AC 240V LED, IP65	ND16-22DS/4C 240V ORG	828180
22mm	Curved surface	Resistance and capacitance type, compact	White, AC 240V LED, IP65	ND16-22DS/4C 240V WHT	828175
22mm	Curved surface	Resistance and capacitance type, compact	Red, AC 240V LED, IP65	ND16-22DS/4C 240V RED	828177
22mm	Curved surface	Resistance and capacitance type, compact	Green, AC 240V LED, IP65	ND16-22DS/4C 240V GRN	828179
22mm	Curved surface	Resistance and capacitance type, compact	Blue, AC 240V LED, IP65	ND16-22DS/4C 240V BLU	828176
22mm	Curved surface	Resistance and capacitance type, compact	Yellow, AC 240V LED, IP65	ND16-22DS/4C 240V YEL	828178
22mm	Curved surface	Resistance and capacitance type, compact	Orange, AC 380V LED, IP65	ND16-22DS/4C 380V ORG	828192
22mm	Curved surface	Resistance and capacitance type, compact	White, AC 380V LED, IP65	ND16-22DS/4C 380V WHT	828187

Diameter	Shape of the head	Internal structure	Color or function	Model Description	Code
22mm	Curved surface	Resistance and capacitance type, compact	Red, AC 380V LED, IP65	ND16-22DS/4C 380V RED	828189
22mm	Curved surface	Resistance and capacitance type, compact	Green, AC 380V LED, IP65	ND16-22DS/4C 380V GRN	828191
22mm	Curved surface	Resistance and capacitance type, compact	Blue, AC 380V LED, IP65	ND16-22DS/4C 380V BLU	828188
22mm	Curved surface	Resistance and capacitance type, compact	Yellow, AC 380V LED, IP65	ND16-22DS/4C 380V YEL	828190
22mm	Curved surface	Resistance and capacitance type, compact	Orange, AC 400V LED, IP65	ND16-22DS/4C 400V ORG	828204
22mm	Curved surface	Resistance and capacitance type, compact	White, AC 400V LED, IP65	ND16-22DS/4C 400V WHT	828199
22mm	Curved surface	Resistance and capacitance type, compact	Red, AC 400V LED, IP65	ND16-22DS/4C 400V RED	828201
22mm	Curved surface	Resistance and capacitance type, compact	Green, AC 400V LED, IP65	ND16-22DS/4C 400V GRN	828203
22mm	Curved surface	Resistance and capacitance type, compact	Blue, AC 400V LED, IP65	ND16-22DS/4C 400V BLU	828200
22mm	Curved surface	Resistance and capacitance type, compact	Yellow, AC 400V LED, IP65	ND16-22DS/4C 400V YEL	828202
22mm	Flat surface	Buzzer	Red, intermittent, AC 110V	ND16-22F AC 110V RED	593389
22mm	Flat surface	Buzzer	Black, intermittent, AC 110V	ND16-22F AC 110V BLK	593388
22mm	Flat surface	Buzzer	Red, intermittent, AC 220V	ND16-22F AC 220V RED	593391
22mm	Flat surface	Buzzer	Black, intermittent, AC 220V	ND16-22F AC 220V BLK	593390
22mm	Flat surface	Buzzer	Red, intermittent, AC 230V	ND16-22F AC 230V RED	828373
22mm	Flat surface	Buzzer	Black, intermittent, AC 230V	ND16-22F 230V BLK	268685
22mm	Flat surface	Buzzer	Red, intermittent, AC 240V	ND16-22F 240V RED	268725
22mm	Flat surface	Buzzer	Black, intermittent, AC 240V	ND16-22F 240V BLK	268726
22mm	Flat surface	Buzzer	Red, intermittent, AC 380V	ND16-22F AC 380V RED	593393
22mm	Flat surface	Buzzer	Black, intermittent, AC 380V	ND16-22F AC 380V BLK	593392
22mm	Flat surface	Buzzer	Red, intermittent, AC 400V	ND16-22F 400V RED	268826
22mm	Flat surface	Buzzer	Black, intermittent, AC 400V	ND16-22F 400V BLK	268827
22mm	Flat surface	Buzzer	Red, intermittent, AC/DC 110V	ND16-22F AC/DC 110V RED	593387
22mm	Flat surface	Buzzer	Black, intermittent, AC/DC 110V	ND16-22F AC/DC 110V BLK	593386
22mm	Flat surface	Buzzer	Red, intermittent, AC/DC 24V	ND16-22F AC/DC 24V RED	593381
22mm	Flat surface	Buzzer	Black, intermittent, AC/DC 24V	ND16-22F AC/DC 24V BLK	593380
22mm	Flat surface	Buzzer	Red, intermittent, AC/DC 36V	ND16-22F AC/DC 36V RED	593383
22mm	Flat surface	Buzzer	Black, intermittent, AC/DC 36V	ND16-22F AC/DC 36V BLK	593382
22mm	Flat surface	Buzzer	Red, intermittent, AC/DC 48V	ND16-22F AC/DC 48V RED	593385
22mm	Flat surface	Buzzer	Black, intermittent, AC/DC 48V	ND16-22F AC/DC 48V BLK	593384
22mm	Flat surface	Buzzer	Red, intermittent, AC 110V, LED flashing	ND16-22FS AC 110V RED	593398
22mm	Flat surface	Buzzer	Red, intermittent, AC 220V, LED flashing	ND16-22FS AC 220V RED	593399
22mm	Flat surface	Buzzer	Red, intermittent, AC 230V, LED flashing	ND16-22FS AC 230V RED	593400
22mm	Flat surface	Buzzer	Red, intermittent, AC 240V, LED flashing	ND16-22FS AC 240V RED	593918
22mm	Flat surface	Buzzer	Red, intermittent, AC 380V, LED flashing	ND16-22FS AC 380V RED	593401
22mm	Flat surface	Buzzer	Red, intermittent, AC 400V, LED flashing	ND16-22FS 400V RED	268828
22mm	Flat surface	Buzzer	Red, intermittent, AC/DC 110V, LED flashing	ND16-22FS AC/DC 110V RED	593397
22mm	Flat surface	Buzzer	Red, intermittent, AC/DC 24V, LED flashing	ND16-22FS AC/DC 24V RED	593394
22mm	Flat surface	Buzzer	Red, intermittent, AC/DC 36V, LED flashing	ND16-22FS AC/DC 36V RED	593395
22mm	Flat surface	Buzzer	Red, intermittent, AC/DC 48V, LED flashing	ND16-22FS AC/DC 48V RED	593396
22mm	Flat surface	Buzzer	Red, continuous, AC 110V	ND16-22L AC 110V RED	593482
22mm	Flat surface	Buzzer	Black, continuous, AC 110V	ND16-22L AC 110V BLK	593481
22mm	Flat surface	Buzzer	Red, continuous, AC 220V	ND16-22L AC 220V RED	593484
22mm	Flat surface	Buzzer	Black, continuous, AC 220V	ND16-22L AC 220V BLK	593483

Diameter	Shape of the head	Internal structure	Color or function	Model Description	Code
22mm	Flat surface	Buzzer	Red, continuous, AC 230V	ND16-22L AC 230V RED	828372
22mm	Flat surface	Buzzer	Black, continuous, AC 230V	ND16-22L 230V BLK	268686
22mm	Flat surface	Buzzer	Red, continuous, AC 240V	ND16-22L 240V RED	268728
22mm	Flat surface	Buzzer	Black, continuous, AC 240V	ND16-22L 240V BLK	268729
22mm	Flat surface	Buzzer	Red, continuous, AC 380V	ND16-22L AC 380V RED	593486
22mm	Flat surface	Buzzer	Black, continuous, AC 380V	ND16-22L AC 380V BLK	593485
22mm	Flat surface	Buzzer	Red, continuous, AC 400V	ND16-22L 400V RED	268829
22mm	Flat surface	Buzzer	Black, continuous, AC 400V	ND16-22L 400V BLK	268830
22mm	Flat surface	Buzzer	Red, continuous, AC/DC 110V	ND16-22L AC/DC 110V RED	593480
22mm	Flat surface	Buzzer	Black, continuous, AC/DC 110V	ND16-22L AC/DC 110V BLK	593479
22mm	Flat surface	Buzzer	Red, continuous, AC/DC 24V	ND16-22L AC/DC 24V RED	593474
22mm	Flat surface	Buzzer	Black, continuous, AC/DC 24V	ND16-22L AC/DC 24V BLK	593473
22mm	Flat surface	Buzzer	Red, continuous, AC/DC 36V	ND16-22L AC/DC 36V RED	593476
22mm	Flat surface	Buzzer	Black, continuous, AC/DC 36V	ND16-22L AC/DC 36V BLK	593475
22mm	Flat surface	Buzzer	Red, continuous, AC/DC 48V	ND16-22L AC/DC 48V RED	593478
22mm	Flat surface	Buzzer	Black, continuous, AC/DC 48V	ND16-22L AC/DC 48V BLK	593477
22mm	Flat surface	Buzzer	Red, continuous, AC 110V, LED lighting	ND16-22LC AC 110V RED	593470
22mm	Flat surface	Buzzer	Red, continuous, AC 220V, LED lighting	ND16-22LC AC 220V RED	593471
22mm	Flat surface	Buzzer	Red, continuous, AC 230V, LED lighting	ND16-22LC AC 230V RED	593910
22mm	Flat surface	Buzzer	Red, continuous, AC 240V, LED lighting	ND16-22LC 240V RED	268730
22mm	Flat surface	Buzzer	Red, continuous, AC 380V, LED lighting	ND16-22LC AC 380V RED	593472
22mm	Flat surface	Buzzer	Red, continuous, AC 400V, LED lighting	ND16-22LC 400V RED	268831
22mm	Flat surface	Buzzer	Red, continuous, AC/DC 110V, LED lighting	ND16-22LC AC/DC 110V RED	593469
22mm	Flat surface	Buzzer	Red, continuous, AC/DC 24V, LED lighting	ND16-22LC AC/DC 24V RED	593466
22mm	Flat surface	Buzzer	Red, continuous, AC/DC 36V, LED lighting	ND16-22LC AC/DC 36V RED	593467
22mm	Flat surface	Buzzer	Red, continuous, AC/DC 48V, LED lighting	ND16-22LC AC/DC 48V RED	593468