

Fixed height with horizontal outlet - Square top

Product information for the product group

ACO Product benefits

- Fully inspectable and cleanable
- Fully removable and easily cleanable stainless steel foul air trap (FAT)
- Full drainability
- Internal radii equal or larger than 3 mm
- Fully welded hygienic joints
- Steel thickness min. 1,5 mm
- Edge infill
- ACO protective cover available
- Fully pickled and passivated

- BIM models are available in ACO Building Drainage BIM Revit libraries
- Adjustable EasyFix leveling feet
- Hygienic design following EN 1672, EN ISO 14159 and EHEDG document 8, 13 and 44
- Certified according to EN 1253-1
- Available in 1.4301 (304) or 1.4404 (316L) grades of stainless steel
- Outlet diameter 75 or 110 mm
- Gully top size 200 x 200 mm or 250 x 250 mm
- Adjustable EasyFix levelling feet
- Wide range of gratings for load class L 15, R 50, M 125 or N 250 (EN 1253-1) including slip resistant solution
- Silt basket available as accessory

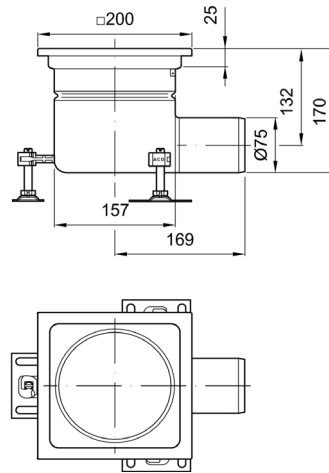











Item Technical Data 408009





Gully top dimensions	Outlet diameter \varnothing	Odour trap	Flow rate EN 1253-1 / Direct *	Material
[mm]	[mm]		[l/s]	
200 x 200	75	With	4.2	1.4301

Standard edge

Accessories

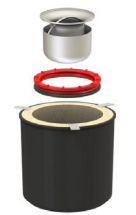
	Description	Used with	Weight [kg]	Item number
	ACO mesh tundish 200	■ ACO gully tops with frame dimensions 200 x 200 mm		
	FeaturesGrating width x length (mm): 168 mm x 168 mm; Grating height (mm): 25 mm; Funnel width x length (mm): 223 mm x 223 mm; Funnel height (mm): 100 mm; Material (EN 1253): 1.4301			450636
	FeaturesGrating width x length (mm): 168 mm x 168 mm; Grating height (mm): 25 mm; Funnel width x length (mm): 223 mm x 223 mm; Funnel height (mm): 200 mm; Material (EN 1253): 1.4301			450637
	ACO quadrato tundish 200	■ ACO gully tops with frame dimensions 200 x 200 mm		
	FeaturesGrating width x length (mm): 168 mm x 168 mm; Grating height (mm): 25 mm; Funnel width x length (mm): 223 mm x 223 mm; Funnel height (mm): 100 mm; Material (EN 1253): 1.4301			450642
	FeaturesGrating width x length (mm): 168 mm x 168 mm; Grating height (mm): 25 mm; Funnel width x length (mm): 223 mm x 223 mm; Funnel height (mm): 200 mm; Material (EN 1253): 1.4301			450643
	ACO Easy FAT 157 Replacement sealing ring: ■ 98402 Optional compatible silt baskets: ■ 416906 (1.4301) ■ 416907 (1.4404)	■ ACO gully 157, fixed height	0.89	
	BenefitsUser-friendly installation and maintenance; Complete ease in removing and cleaning; Minimum steel thickness of 1.2 mm; Fully pickled and passivated; Extensively tested and classified in accordance with EN 1253-1 guidelines-FeaturesMaximum flow rate with horizontal gully: 2.6 l/s; Maximum flow rate with vertical gully: 2.6 l/s; Material: 1.4301; Silt basket not included			449681
	BenefitsUser-friendly installation and maintenance; Complete ease in removing and cleaning; Minimum steel thickness of 1.2 mm; Fully pickled and passivated; Extensively tested and classified in accordance with EN 1253-1 guidelines-FeaturesMaximum flow rate with horizontal gully: 2.6 l/s; Maximum flow rate with vertical gully: 2.6 l/s; Material: 1.4404; Silt basket not included			449683
	ACO tundish portable	■ Universal		

	Description	Used with	Weight [kg]	Item number
	Base width x length (mm): 250 mm x 286 mm; Funnel width x length (mm): x; Funnel height (mm): 100 mm; Material (EN 1253): 1.4301			450648
	Base width x length (mm): 250 mm x 286 mm; Funnel width x length (mm): x; Funnel height (mm): 200 mm; Material (EN 1253): 1.4301			450649
	ACO Easy FAT 157 Replacement sealing ring: ■ 98402	■ ACO gully 157, fixed height	1.09	
	BenefitsUser-friendly installation and maintenance; Complete ease in removing and cleaning; Minimum steel thickness of 1.2 mm; Fully pickled and passivated; Extensively tested and classified in accordance with EN 1253-1 guidelines-FeaturesMaximum flow rate with horizontal gully: 2.4 l/s; Maximum flow rate with vertical gully: 2.4 l/s; Material: 1.4301; Silt basket included			449682
	BenefitsUser-friendly installation and maintenance; Complete ease in removing and cleaning; Minimum steel thickness of 1.2 mm; Fully pickled and passivated; Extensively tested and classified in accordance with EN 1253-1 guidelines-FeaturesMaximum flow rate with horizontal gully: 2.4 l/s; Maximum flow rate with vertical gully: 2.4 l/s; Material: 1.4404; Silt basket included			449684
	Silt basket ■ Stainless steel ■ 0,6 litre capacity	<ul style="list-style-type: none"> ■ ACO gully 157 - vertical <ul style="list-style-type: none"> <input type="checkbox"/> Fixed height or telescopic ■ ACO hygienic box channel <ul style="list-style-type: none"> <input type="checkbox"/> Channel dimension <input type="checkbox"/> Width Wo [mm]: 300, 400, 500, 600, 800 <input type="checkbox"/> Outlet øD [mm]: 142 or welded with ACO hygienic gully 157 <input type="checkbox"/> Direction of gully outlet: vertical 		
	Material grade 1.4301 (304)			416904
	Material grade 1.4404 (316L)			416905
	Silt basket ■ Stainless steel ■ 0,3 litre capacity	<ul style="list-style-type: none"> ■ ACO gully 142 and 157 - horizontal <ul style="list-style-type: none"> <input type="checkbox"/> Fixed height or Telescopic ■ ACO hygienic box channel <ul style="list-style-type: none"> <input type="checkbox"/> Channel dimension <input type="checkbox"/> Width Wo [mm]: 300, 400, 500, 600, 800 <input type="checkbox"/> Outlet øD [mm]: 142 or welded with ACO hygienic gully 157 <input type="checkbox"/> Direction of gully outlet: horizontal 		
	Material grade 1.4301 (304)			416906
	Material grade 1.4404 (316L)			416907

	Description	Used with	Weight	Item number
			[kg]	
	<ul style="list-style-type: none"> ■ Fixed height, vertical ■ Telescopic, vertical ■ Made from 1.4404 (316) grade of stainless steel ■ NBR 	<ul style="list-style-type: none"> ■ ACO hygienic gully 157 <input type="checkbox"/> Fixed height, vertical <input type="checkbox"/> Telescopic, vertical 		
	ACO fire resistant kit for gully 157/ DN 75			416932
	ACO fire resistant kit for gully 157/ DN 110			416933
	Odour trap <ul style="list-style-type: none"> ■ Height: 50 mm 	<ul style="list-style-type: none"> ■ ACO hygienic gully 157 <input type="checkbox"/> Telescopic 		
	Material grade 1.4301 (304)			408200
	Material grade 1.4404 (316L)			408210
	Standard foul air trap support NBR	<ul style="list-style-type: none"> ■ ACO hygienic gully 157 <input type="checkbox"/> Fixed height <input type="checkbox"/> Telescopic 		408201
	Friction ring SBR	<ul style="list-style-type: none"> ■ ACO hygienic gully 157 <input type="checkbox"/> Telescopic 		408205

You can find further accessories under → <https://www.buildingdrainage.aco/search/?q=408009>