

EMKV 40

Cable gland, brass

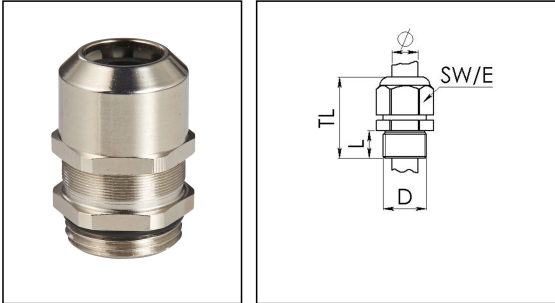

Product illustrations are exemplary and may differ from the chosen product. Further variants and individual customization, we will gladly provide you on request.



Material cable gland	Brass nickel-plated
Material clamping cage	Polyamide
Material sealing gasket	EPDM
Temp. range min	-40 °C
Temp. range max	100 °C
Intermittent temp. range	120 °C
Protection class	IP 68, 5 bar 30 min
Thread type	M
Ø Connection thread D	40
Lead	1,5
Length screw-in thread L	8 mm
Ø cable diameter min	16 mm
Ø cable diameter max	28 mm
Key width SW	44 mm
Collar diameter (E)	48 mm
Type of cable anchorage	A
Total length TL	40 mm - 53 mm
Install. torques fitting	20 N m
Install. torques cap nut	25 N m
Impact category	6
Surface	Nickel-plated
Order no. nickel-plated	10103086
Type	EMKV 40
Packing unit	10

15.01.2016

