



EMS1000 PRO

User Manual

Version 0.0

www.solaxpower.com



eManual in the QR code or at <http://kb.solaxpower.com/>

STATEMENT

Copyright

Copyright © SolaX Power Network Technology (Zhejiang) Co., Ltd. All rights reserved.

No part of this manual may be reproduced, transmitted, transcribed, stored in a retrieval system, or translated into any language or computer language, in any form or by any means without the prior written permission of SolaX Power Network Technology (Zhejiang) Co., Ltd.

Trademarks



SOLA X and other symbol or design (brand name, logo) that distinguishes the products or services offered by SolaX has been trademark protected. Any unauthorized use of the above stated trademark may infringe the trademark right.

Notice

Please note that certain products, features, and services mentioned in this document may not be within the scope of your purchase or usage. Unless otherwise specified in the contract, the contents, information, and recommendations presented in this document are provided "as is" by SolaX. We do not provide any warranties, guarantees, or representations, whether express or implied.

The content of the documents is reviewed and updated as needed. However, occasional discrepancies may occur. SolaX retains the right to make improvements or changes in the product(s) and the program(s) described in this manual at any time without prior notice.

The images included in this document are solely for illustrative purposes and may differ based on the specific product models.

For more detailed information, kindly visit the website of SolaX Power Network Technology (Zhejiang) Co., Ltd. at www.solaxpower.com.

SolaX retains all rights for the final explanation.

About This Manual

Scope of Validity

This manual is an integral part of EMS1000 PRO (hereinafter referred to as "EMS1000 PRO" or "the Device"). It introduces the installation, electrical connection and webpage operations of the Device. Please read it carefully before operating.



Target Group

This manual is intended for EMS1000 PRO installers, operators and maintenance personnel. Among the manual, the installation and electric connection procedures can only be performed by qualified personnel who:

- Are licensed and/or satisfy state and local regulations.
- Have good knowledge of this manual and other related documents.





Conventions

The symbols that may be found in this manual are defined as follows.

Symbol	Description
 DANGER	Indicates a hazardous situation which, if not avoided, will result in death or serious injury.
 WARNING	Indicates a hazardous situation which, if not avoided, could result in death or serious injury.
 CAUTION!	Indicates a hazardous situation which, if not avoided, could result in minor or moderate injury.
NOTICE!	Provides tips for the optimal operation of the product.

Frequently Used Functions

Icons and parameters that may be found on the webpage of EMS1000 PRO and this manual are defined as follows:

Parameter/Icon	Description
	The parameter must be configured.
	Cancel selection or close the current page
	Display the content that you entered
	Hide the content that you entered
	View the description for the function or parameter

Change History

Version 0.0 (2025-03-31)

Initial release

Table of Contents

- 1 Safety 1
 - 1.1 General Safety 1
 - 1.2 Explanation of Symbols 1
- 2 Product Overview 3
 - 2.1 Introduction..... 3
 - 2.2 Features 3
 - 2.3 Appearance 4
 - 2.4 Definition of Indicators 4
- 3 Installation Preparation..... 5
 - 3.1 Installation Requirements..... 5
 - 3.2 Scope of Delivery..... 7
 - 3.3 Tool Requirements..... 8
- 4 Installation Procedure 9
 - 4.1 Cabinet Installation 9
 - 4.2 Din-rail Installation 9
 - 4.3 Wall-mounting Installation..... 10
- 5 Electrical Connection 12
 - 5.1 Device Terminals..... 12
 - 5.2 Cable Requirements 14
 - 5.3 Network Cable Connection..... 15
 - 5.4 4G SIM Card Installation 16
 - 5.5 RS485 Cable Connection 16
 - 5.6 DO Port Connection 18
 - 5.7 DI Port Connection..... 19
 - 5.8 Antenna Connection 20
- 6 Webpage Operations 22
 - 6.1 Logging in 22
 - 6.2 Webpage Layout 23
 - 6.3 Changing Password 24
 - 6.4 Overview 25
 - 6.5 Device List..... 29
 - 6.5.1 Adding Devices 29
 - 6.5.2 Viewing Devices..... 32

6.5.3	Searching for Devices	33
6.6	System Overview	33
6.6.1	EMS1000 PRO	34
6.6.2	AC Switching Cabinet	40
6.6.3	Grid Meter	42
6.6.4	Cabinet	46
6.6.5	Inverter	49
6.6.6	Battery	56
6.6.7	Air Conditioning	63
6.6.8	Supervision System	68
6.6.9	Grid-connected inverter	71
6.7	Alarm Information	72
6.7.1	Viewing Alarms	72
6.7.2	Deleting Alarms	73
6.7.3	Searching for Alarms	75
6.8	System Settings	76
6.8.1	Work Mode	76
6.8.2	Remote Settings	82
6.8.3	Import Settings	83
6.8.4	Export Settings	83
6.8.5	External Control	84
6.8.6	AC Switching Cabinet Settings	85
6.9	System O&M	87
6.10	Settings	88
6.10.1	RS485 Settings	88
6.10.2	EMS Maintenance	89
6.10.3	EMS System Upgrade	91
6.10.4	Network Settings	92
7	Maintenance and Troubleshooting	93
7.1	Maintenance	93
7.2	Troubleshooting	93
8	Technical Data	96

1 Safety

1.1 General Safety

EMS1000 PRO has been meticulously designed and tested to comply with the relevant state and international safety standards. Nevertheless, like all electrical and electronic equipment, safety precautions must be observed and followed during the installation and electrical connection of the Device to minimize the risk of personal injury.



Please thoroughly read, comprehend, and strictly adhere to the comprehensive instructions provided in the user manual and any other relevant regulations prior to the installation of the Device. The safety instructions in this document serve as supplementary guidelines to local laws and regulations.

SolaX shall not be liable for any consequences resulting from the violation of the storage, transportation, installation, and operation regulations outlined in this document. Such consequences include, but are not limited to:

- Device damage due to force majeure, such as earthquake, flooding, thunderstorm, lighting, fire hazard, volcanic eruption and overvoltage
- Device damage due to human causes
- Failure to follow the operation instructions and safety precautions on the product and in this document
- Installation and use under improper environment or electrical condition
- Unauthorized modifications to the product or software
- Use of incompatible devices

1.2 Explanation of Symbols

Table 1-1 Symbols on Device labels

Symbol	Description
	CE mark of conformity
	RCM mark of conformity
	Do not dispose of the device together with household waste.

EU DECLARATION OF CONFORMITY

WiFi EIRP: 802.11b/g/n: 18 dBm

- This equipment complies with CE radiation exposure limits set forth for an uncontrolled environment. This equipment should be installed and operated with a minimum distance of 20 cm between the radiator and your body.
- Hereby, SolaX Power Network Technology (Zhejiang) Co., Ltd. declares that EMS1000 PRO supports 2.4G WiFi, 2G, 3G and 4G functions. It is in conformity with the relevant union harmonization legislation: Radio Equipment Directive: 2014/53/EU.
- The full text of the EU declaration of conformity is available at the following internet address: www.solaxpower.com.
- Band specification:
 - » GSM/GPRS/EGPRS900: 35 dBm
 - » GSM/GPRS/EGPRS1800: 32 dBm
 - » WCDMA Band I: 25 dBm
 - » WCDMA Band VIII: 25 dBm
 - » LTE Band 1: 25 dBm
 - » LTE Band 3: 25 dBm
 - » LTE Band 7: 25 dBm
 - » LTE Band 8: 25 dBm
 - » LTE Band 20: 25 dBm
 - » LTE Band 28: 25 dBm
 - » LTE Band 38: 25 dBm
 - » LTE Band 40: 25 dBm

2 Product Overview

2.1 Introduction

EMS1000 PRO is an all-in-one device for photovoltaic energy management, suitable for industrial and commercial power stations, large ground power stations, data acquisition, energy control, intelligent operation and maintenance of inverters and batteries. Support inverter, combiner box, meter and other equipment data acquisition, protocol conversion.

2.2 Features

Smart & Flexible

- Supports RS485, Ethernet, and 4G
- Supports connection of 120 inverters
- Supports master device managing 10 slave devices
- Built-in web page for local monitoring and remote access

Efficient & Simple

- Automatically searches and assigns inverter addresses
- EMS1000 PRO slave devices are auto-detected
- Supports remote parameter setting and system power adjustment

Stable & Reliable

- Support offline data transmission resume, ensuring no data loss
- Industrial-grade reliability for high stability

2.3 Appearance

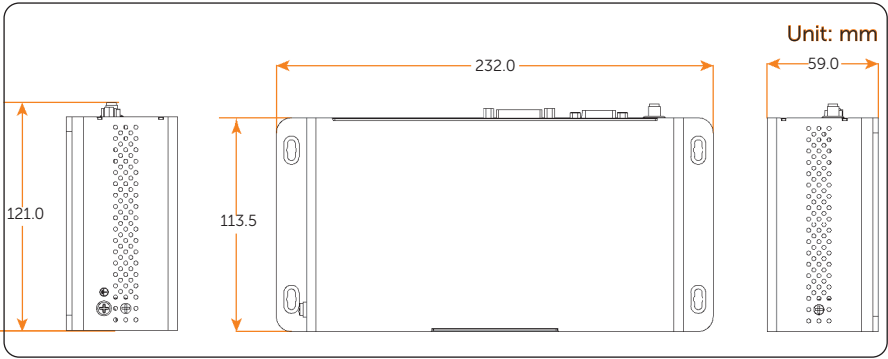











Figure 2-1 Device dimensions

2.4 Definition of Indicators

Check for the indicator status against the table for the operation status of the Device.

Table 2-2 Indicator status description

Indicator	Status	Description
Power (PWR)	 Stead on	Normal power supply
	 Off	No power supply
Running (RUN)	 Blinking	The system runs normally.
	 Stead on	The system crashes.
	 Off	
ERR (Error)	 Stead on	System error occurs.
	 Off	The system runs normally.
SSD	 Stead on	Normal SSD
	 Blinking	Transmitting data
	 Off	Lack of SSD or abnormal SSD

3 Installation Preparation

3.1 Installation Requirements

Before installing the device, select a proper installation site and prepare the tools based on the following instructions.

Environment requirements

Make sure the installation environment meets the following conditions:

- The ambient temperature: -40°C to $+60^{\circ}\text{C}$.
- The relative humidity shall be between 5-95%RH.
- Avoid rain exposure and snow accumulation.
- Do not install the Device in areas with flammable and explosive materials.
- Avoid signal interference.

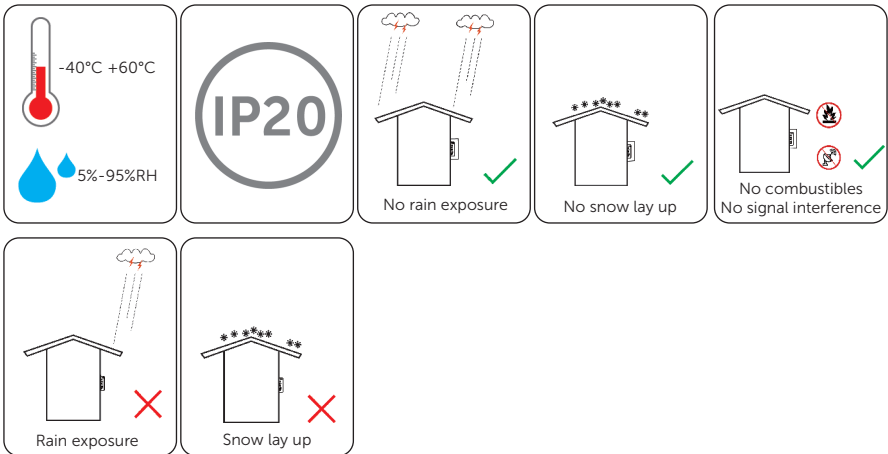

Installation carrier requirements

The installation carrier must be made of a non-flammable material, and the Device must be protected against water with a waterproof box or other waterproof measures.

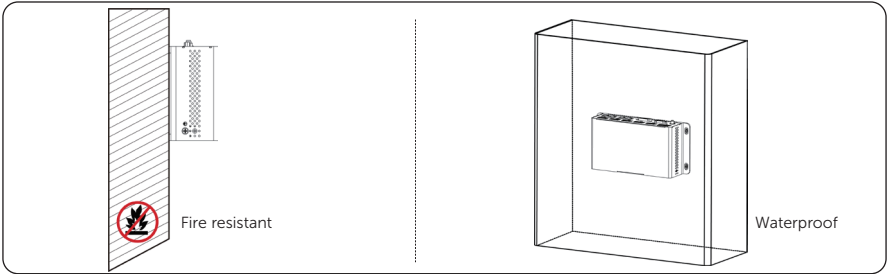

Figure 3-2 Installation carrier requirement

Clearance requirements

To guarantee proper heat dissipation and ease of disassembly, the minimum space around EMS1000 PRO must meet the standards below.

For installations with multiple Devices, make sure to leave a minimum space of 300 mm between each Device.

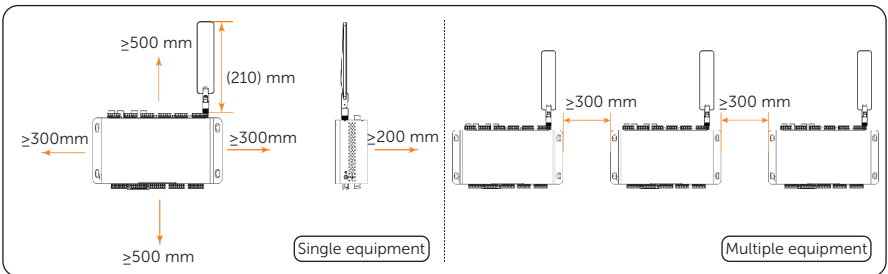

Figure 3-3 Clearance requirements

NOTICE!

Multiple models of antenna are available, and the antenna dimensions vary with the model.

3.2 Scope of Delivery

Before acceptance, check whether the Device and all accessories listed below are included in the package and are in good condition. If there is anything missing or damaged, please return it to us.

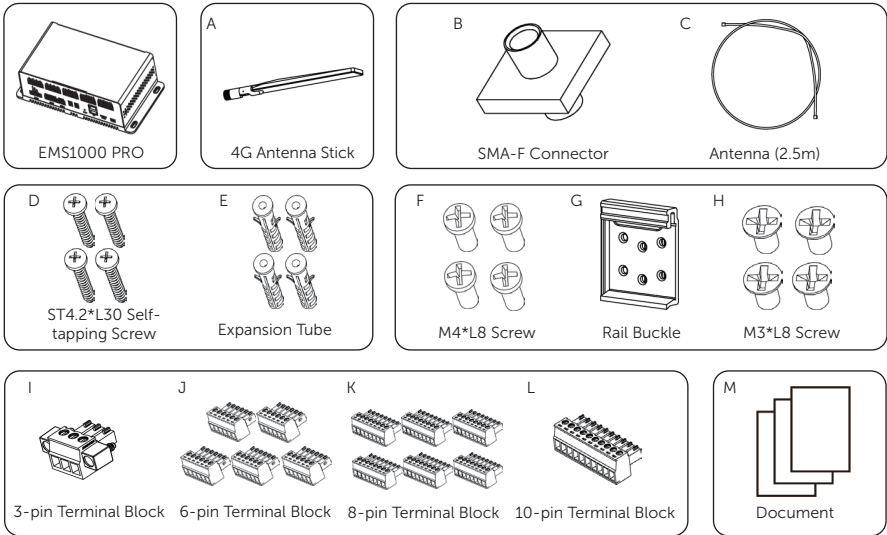

Table 3-1 Scope of delivery

Item	Description	Quantity	Remarks
/	EMS1000 PRO	1	
A	4G Antenna Stick	1	
B	SMA-F Connector	1	For connecting the antenna
C	Antenna (2.5m)	1	
D	ST4.2*L30 Self-tapping Screw	4	For device wall mounting
E	Expansion Tube	4	
F	M4*L8 Screw	4	Reserved
G	Rail Buckle	1	For device rail mounting
H	M3*L8 Screw	4	
I	3-pin Terminal Block	1	For power connection
J	6-pin Terminal Block	5	For RS485 connection
K	8-pin Terminal Block	6	For DI and DO connection









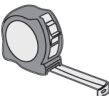

Installation Preparation

Item	Description	Quantity	Remarks
L	10-pin Terminal Block	1	Reserved
M	Document	/	

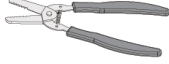
*Note: Accessories in the same box are packed together in one bag.

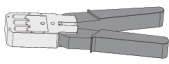
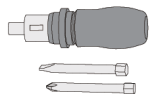
3.3 Tool Requirements

Installation tools include but are not limited to the followings. If necessary, use other auxiliary tools on site. Please note that the tools used must comply with local regulations.

 <p>Hammer drill (Drill bit: 6 mm)</p>	 <p>Measuring tape</p>	 <p>Marker</p>	 <p>Rubber mallet</p>
 <p>Spirit level</p>	 <p>Wire stripper</p>	 <p>Marker</p>	 <p>Crimping tool for RJ45</p>
 <p>Torque screwdriver (Flat-head: M2) (Phillips head: M4)</p>			
 <p>Safety gloves</p>	 <p>Safety boots</p>	 <p>Safety goggles</p>	 <p>Anti-dust mask</p>

4 Installation Procedure

EMS1000 PRO supports 3 installation modes: cabinet installation, DIN-rail installation and wall mounting. Select an installation mode according to the on-site conditions.

WARNING!

Only qualified personnel are allowed to perform the mechanical installation in accordance with local laws and regulations.

4.1 Cabinet Installation

EMS1000 PRO can work with multiple cabinet models for energy system management, and is already properly installed and connected before the cabinet is delivered. For specific information, see the user manual of the cabinet.

4.2 Din-rail Installation

Step 1: Align the four holes of the DIN rail buckle (Part G) to the installation holes at the rear of EMS1000 PRO, and then use four M3*L8 screws (Part H) to secure them.

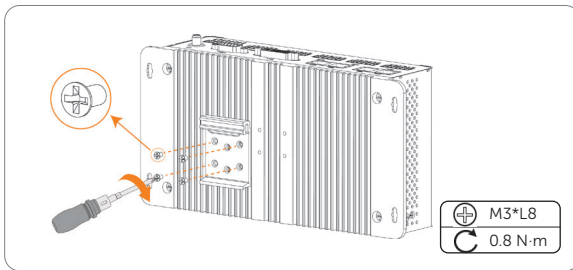

Figure 4-1 Attaching the rail buckle

Step 2: Clasp the combined rail buckle from top to bottom onto the rail.

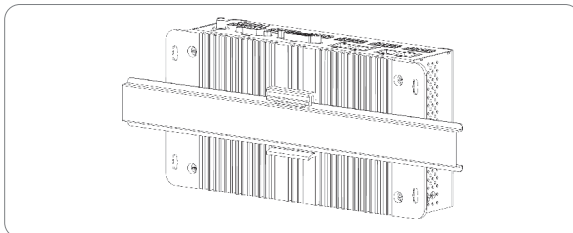

Figure 4-2 Clasping the DIN rail buckle to rail

4.3 Wall-mounting Installation

NOTICE!

For this installation method, ensure that there are enough waterproof measures for the Device.

Step 1: Place EMS1000 PRO onto the wall at a proper height from the ground, use a spirit level to ensure that the Device is horizontal and level, and then mark holes.

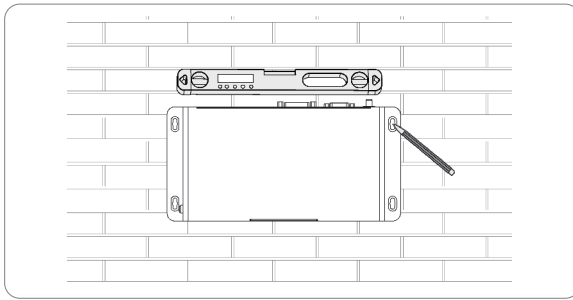

Figure 4-3 Determining the installation position

Step 2: Drill holes into the wall according to the hole marks.

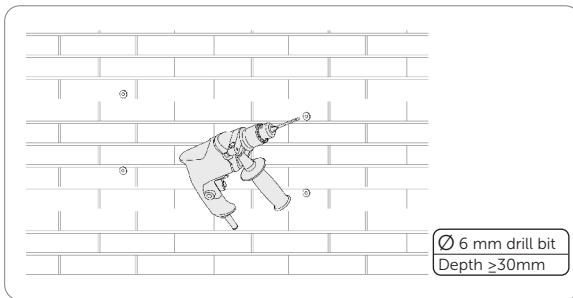

Figure 4-4 Drilling holes

Step 3: Hammer in the expansion tubes (part E).

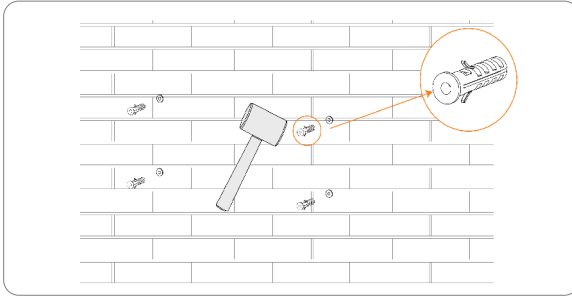

Figure 4-5 Hammering in expansion tubes

Step 4: Use four ST4.2*L30 (part D) self-tapping screws to secure the Device to the wall.

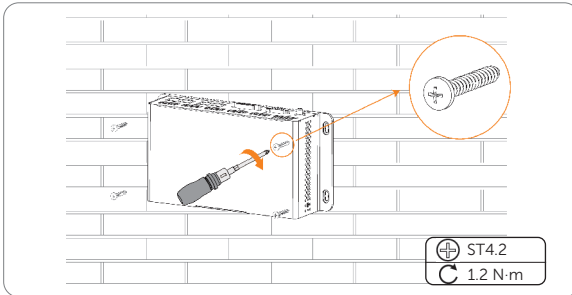

Figure 4-6 Securing the Device

5 Electrical Connection

5.1 Device Terminals

EMS1000 PRO features abundant terminals that can be used to connect different device. You can also develop customized functions for idle terminals.

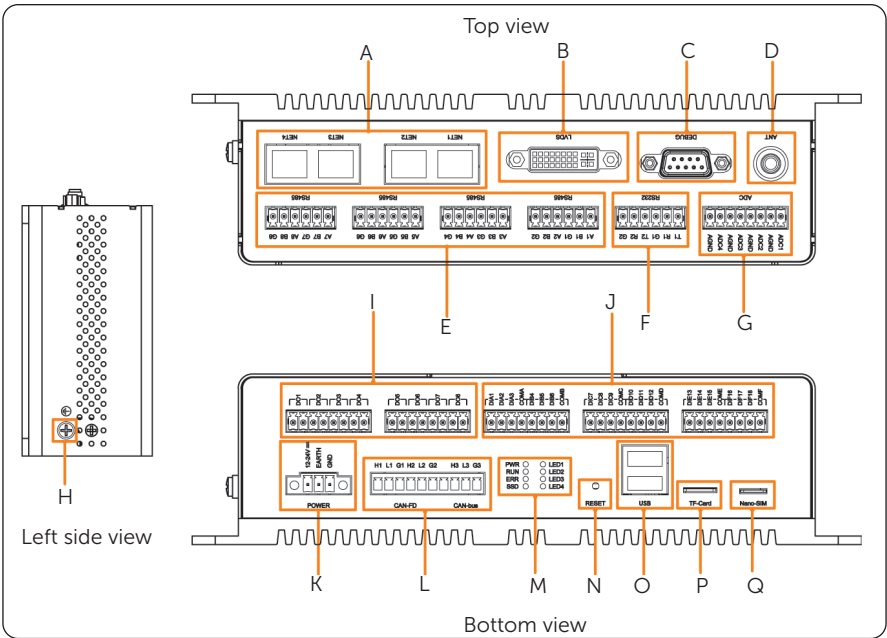

Figure 5-1 EMS1000 PRO appearance

Table 5-1 Description of appearance

Position	Area	Item	QTY.	Description
Top	A	Ethernet terminal (NET)	4	<ul style="list-style-type: none"> NET1: Connected to the subordinate EMS1000 or EMS1000 PRO NET2: Connected to upper EMS1000 PRO NET3: Reserved DEBUG terminal NET4: Connected to the router for network
	B	LVDS terminal	1	Reserved
	C	Debug terminal (DEBUG)	1	Reserved

Position	Area	Item	QTY.	Description
Top	D	Antenna socket (ANT)	1	For expanding signal transmission
	E	RS485 terminal	8	<ul style="list-style-type: none"> • 1-2: Connected to grid-connected inverters, meter, etc. • 3: Connected to temperature and humidity sensor of SolaX AC Switching Cabinet • 4-7: Connected to grid-connected inverters, meter, etc. • 8: Connected to the grid-connected meter
	F	RS232 terminal	2	Reserved
	G	ADC terminal	4	<ul style="list-style-type: none"> • 1-2: For DRM function • 3-4: Reserved
Left	H	Earthing terminal	1	For device earthing
Bottom	I	DO terminal	8	<ul style="list-style-type: none"> • 1-4: Reserved • 5: Connected to Running status (RUN) indicator of SolaX AC Switching Cabinet • 6: Connected to ALARM indicator of SolaX AC Switching Cabinet • 7: Connected to GRID indicator of SolaX AC Switching Cabinet • 8: Connected to diesel generator, when the SolaX AC Switching Cabinet is connected
	J	DI terminal	18	<ul style="list-style-type: none"> • 1-4: Dry contact / DRM function • 5: Reserved • 6: Connected to ATS (Automatic Transfer Switch) or diesel generator • 7: Connected to emergency stop of SolaX AC Switching Cabinet • 8: Connected to water sensor of SolaX AC Switching Cabinet • 9: Connected to SPD of SolaX AC Switching Cabinet • 10: Connected to door sensor of SolaX AC Switching Cabinet • 11: Reserved • 12: Connected to SPD2 of SolaX AC Switching Cabinet • 13-18: Reserved
	K	Power supply (POWER)	1	12 Vdc-24 Vdc
	L	CAN terminal	3	2 × CAN-FD, and 1 × CAN-bus

Position	Area	Item	QTY.	Description
Bottom	M	Indicators	8	<ul style="list-style-type: none"> • Power status (PWR) • Running status (RUN) • Error (ERR) • SSD status (SSD) • LED 1-LED4: Reserved
	N	Reset button (RESET)	1	For device resetting
	O	USB socket (USB)	2	For device update
	P	TF card socket (TF Card)	1	For firmware programming
	Q	Nano-SIM card socket (Nano-SIM)	1	For 4G communication

5.2 Cable Requirements

Cables are not in the scope of delivery of EMS1000 PRO. Please prepare the cables and materials in advance as required below.

Table 5-2 Cable specification

No.	Item	Type	Specification
1	Power adapter	/	24 VDC, 2 A
2	RS485 cable	Four-core or multi-core cables	Cross-sectional area: 0.2 mm ² – 2.5mm ² (24AWG ~14 AWG)
3	DO cable	Dual-core or multi-core cables	Cross-sectional area: 0.2 mm ² – 1.5mm ² (24AWG ~16 AWG)
4	DI cable	Dual-core or multi-core cables	Cross-sectional area: 0.2 mm ² – 1.5mm ² (24AWG ~16 AWG)
5	Network cable	CAT 5E	/
6	RJ45 terminal	Standard RJ45 terminal	/

5.3 Network Cable Connection

Step 1: Strip the insulation layer of the network cable to an appropriate length.

Step 2: Attach the RJ45 connector to the stripped cable, and then use a crimping tool to crimp them.

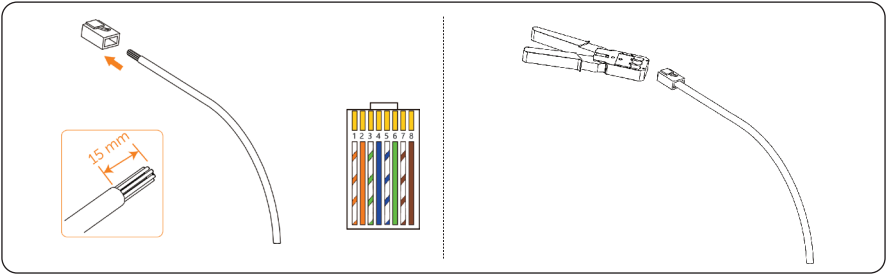

Figure 5-2 Stripping and crimping network cable

Table 5-3 Pin number and color

PIN No.	Color	PIN No.	Color
1	Orange-White	5	Blue-White
2	Orange	6	Green
3	Green-White	7	Brown-White
4	Blue	8	Brown

Step 3: Insert the assembled network cable into the corresponding slot.

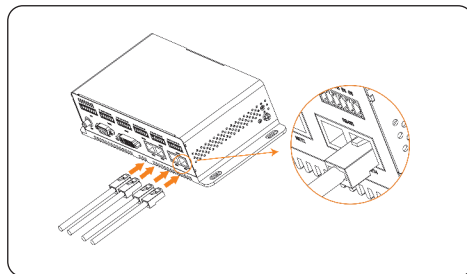

Figure 5-3 Connecting the cable

5.4 4G SIM Card Installation

4G SIM card is not in the scope of delivery. Please prepare a 4G SIM card in advance. Keep the chip downside, and then insert the SIM card into the Nano-SIM slot.

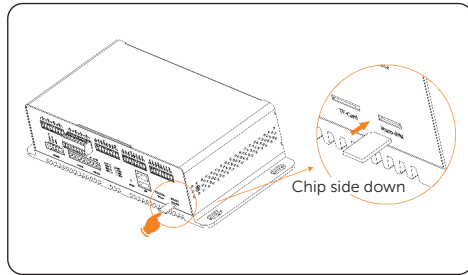

Figure 5-4 Inserting the 4G SIM card

5.5 RS485 Cable Connection

NOTICE!

- Please perform proper insulating measures for wires that are not connected.

Step 1: Strip the insulation layer of the cable and wires to an appropriate length.

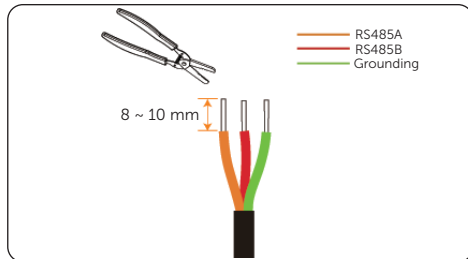

Figure 5-5 Stripping the cable

Step 2: Insert the RS485A, RS485B and grounding wire into the 6-pin terminal block in order, and then use a wrench to secure them.

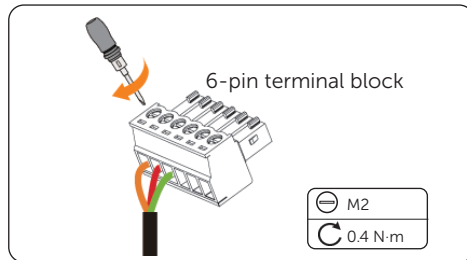

Figure 5-6 Securing wires

Step 3: Insert the terminal block into the RS485 slot based on the device markings.

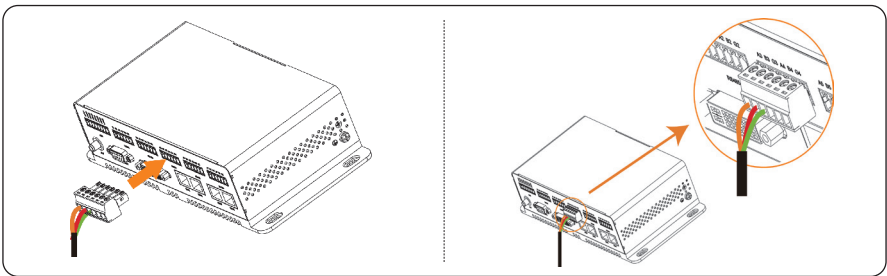

Table 5-4 Inserting the terminal block

Table 5-5 RS485 port description

Port	Marking	Description
RS485 1-8	A	RS485A
	B	RS485B
	G	Ground wire

5.6 DO Port Connection

Step 1: Strip the insulation layer of the cable and wires to an appropriate length.

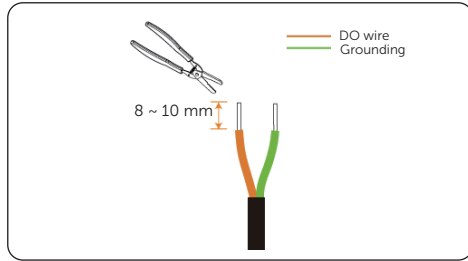

Figure 5-7 Stripping the cable

Step 2: Insert the DO and grounding wire into the 8-pin terminal block in order, and then use a wrench to secure them.

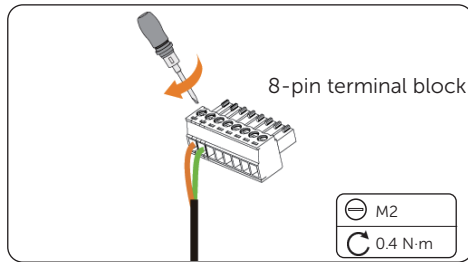

Figure 5-8 Securing wires

Step 3: Insert the terminal block into the DO slot in order based on the device markings.

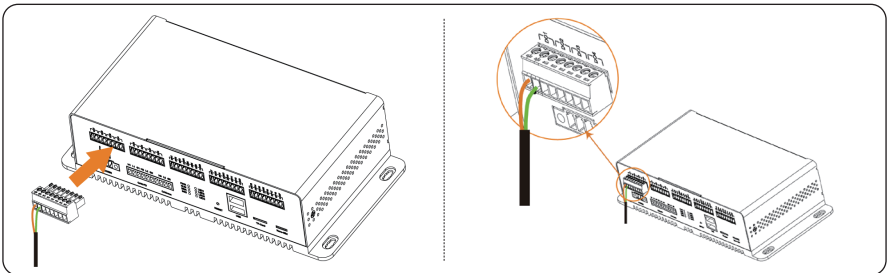

Figure 5-9 Inserting the terminal block

Table 5-7 DI port description

Port	Marking	Description
DO	<ul style="list-style-type: none"> • DO1 • DO2 • DO3 • DO4 • DO5 • DO6 • DO7 • DO8 	Connected to the DO cable and grounding cable

5.7 DI Port Connection

Step 1: Strip the insulation layer of the cable and wires to an appropriate length.

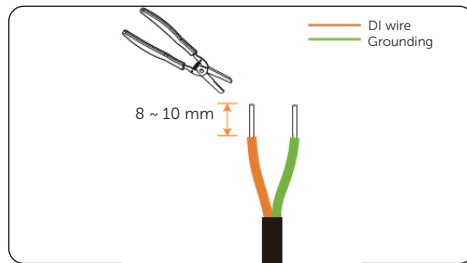

Figure 5-10 Stripping the cable

Step 2: Insert the DI and grounding wire into the 8-pin terminal block in order, and then use a wrench to secure them.

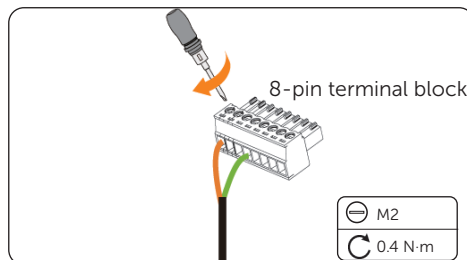

Figure 5-11 Securing wires

Step 3: Insert the terminal block into the DI slot in order based on the device markings.

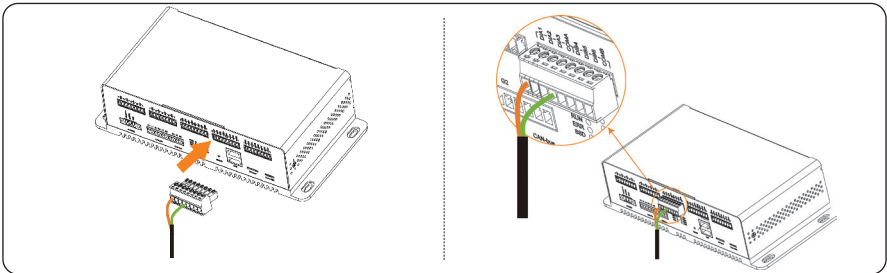

Figure 5-12 Inserting the terminal block

Table 5-8 DI port description

Port	Marking	Description	Remark
DI	<ul style="list-style-type: none"> • DIA1-DIA3 • DIB4-DIB6 • DIC7-DIC9 • DID10-DID12 • DIE13-DIE15 • DIF16-DIF18 	Connected to the DI cable	While connecting the DI cables, make sure that the grounding cable is connected to the corresponding COM terminal.
	<ul style="list-style-type: none"> • COMA • COMB • COMC • COMD • COME • COMF 	Connected to the grounding cable	

5.8 Antenna Connection

The antenna stick can be directly inserted into the antenna slot, or connected through the SMA-F connector. The latter is only applicable to cabinet installation.

Quick Insertion

Insert the antenna stick into the antenna slot, and then swirl it clockwise to fix it.

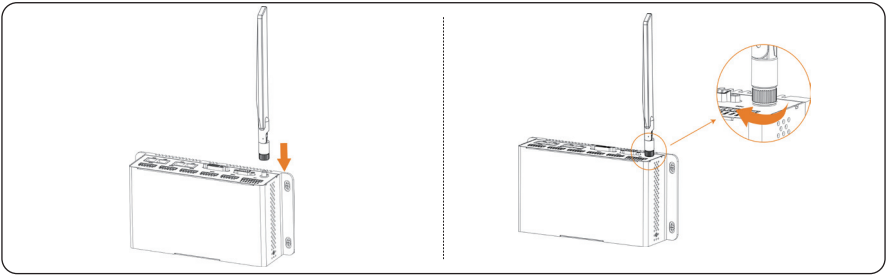

Figure 5-13 Fixing the antenna stick

Connection through SMA-F Connector

Step 1: Connect one end of the antenna to the SMA-F connector, and then fix the other end of the antenna to EMS1000 PRO.

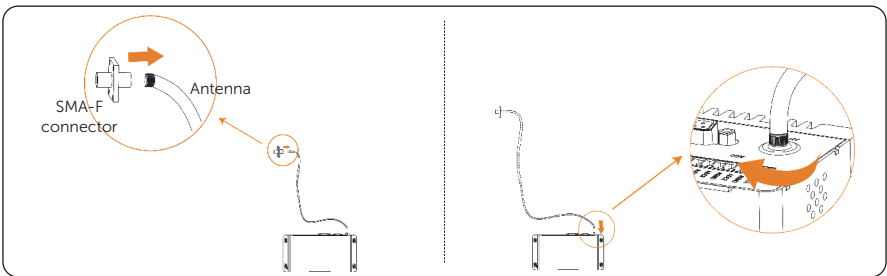

Figure 5-14 Connecting the antenna

Step 2: Swirl the antenna stick clockwise to fix it to the SMA-F connector.

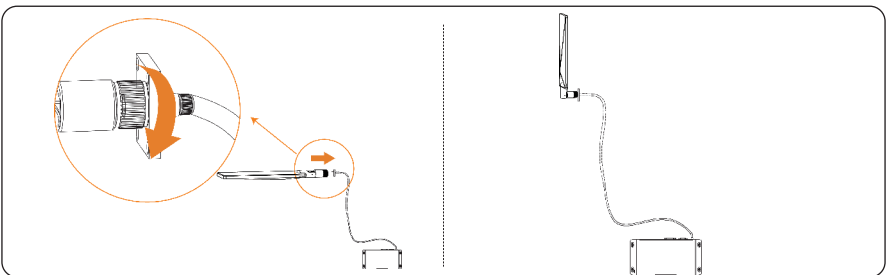

Figure 5-15 Fixing the antenna stick

6 Webpage Operations

View the system information, and manage the power system through EMS1000 PRO webpage.

NOTICE!

Screenshots of V003 software are used for example in this chapter, and the actual page details might vary.

6.1 Logging in

NOTICE!

IE browser is not supported currently, and we recommend logging in to the webpage through Chrome.

Step 1: Connect the computer to NET3 of EMS1000 PRO with a network cable, or connect the computer to EMS1000 PRO hotspot named WiFi_SN, and then go to the defined IP address based on the connection mode.

- » For wired connection: 192.168.14.10
- » For hotspot connection: 192.168.10.10

Step 2: On the login page, select the language, enter the username and password, and then click **Login**.

The default username and password for the user account are user and 123456.

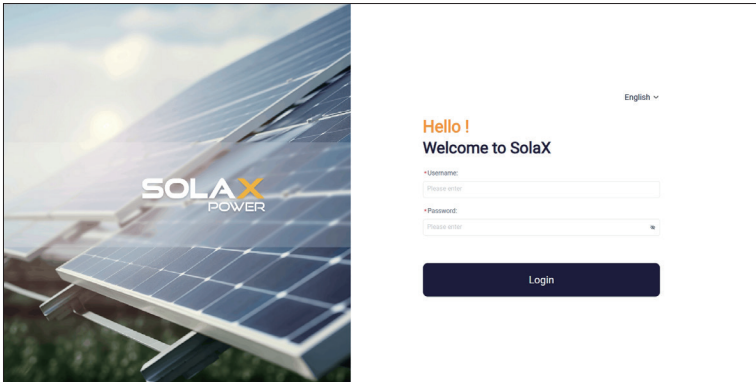

Figure 6-16 Login page

6.2 Webpage Layout

EMS1000 PRO webpage offers a wide range of functions that are logically divided into multiple modules, such as overview, device list, system overview, alarm information, system settings, system O&M and more.

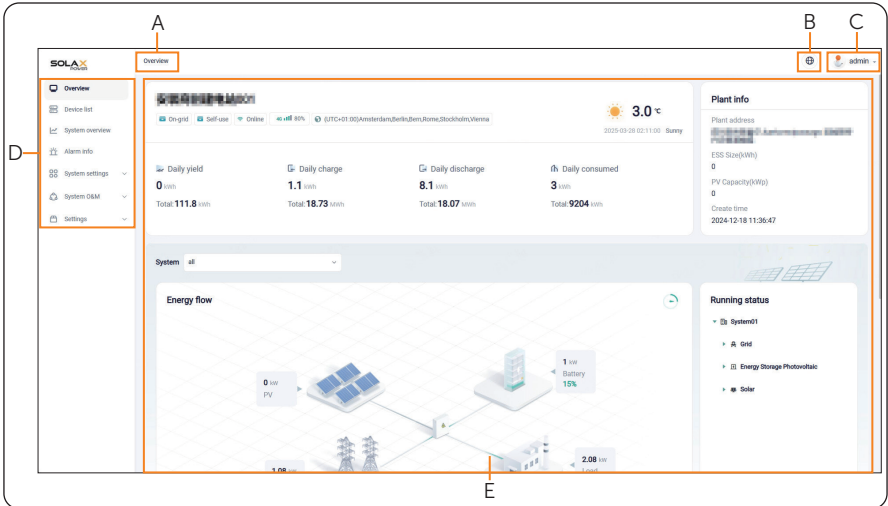



Figure 6-1 Page layout

Table 6-1 Page description

No.	Item	Description
A	Page path	Path of the current page. You can click the main or sub menu in the path to directly go to the defined menu.
B		Click the icon to switch the system language without logging out
C		The current login account, either user or admin. You can click the icon to change password (available only for user account) or log out.
D	Navigation bar	Function items that the Device offers
E	Content area	Detailed information of the selected function item

6.3 Changing Password

We recommend changing the password immediately after logging in to the webpage for the first time.

Step 1: Click **User** on the upper-right corner, and then select **Change Password**.

Step 2: On the **Change Your Password** pop-up, enter the original password, enter and confirm the new password, and then click **Confirm**.

The password should be at least 6-32 characters long, including numbers, uppercase and lowercase letters, and symbols.

The image shows a 'Change password' dialog box with a close button (X) in the top right corner. It contains three required input fields, each with a red asterisk and a label: '* Old password:', '* New password:', and '* Confirm new password:'. Each input field has a placeholder text 'Please enter' and a small eye icon to the right. At the bottom right of the dialog, there are two buttons: a white 'Cancel' button and a green 'Confirm' button.

Figure 6-2 Changing password

NOTICE!

If you forget your password, restore the system to default settings or contact us for technical support.

6.4 Overview

In this menu, you can have an overview of the entire system, including the system information, daily and total revenue and energy details, real-time energy data and power line chart.

Log in to the webpage, and the **Overview** page is displayed by default.

Basic system information

View the time zone and local weather of the plant, and system information including 4G signal strength, connection status of EMS1000 PRO and SolaXCloud platform and system operation mode.



Figure 6-3 Basic system information

Table 6-2 Information description

No.	Description
A	Name of the plant
B	On/Off-grid state
C	Operation mode of the system
D	Connection status of EMS1000 PRO and the SolaXCloud platform
E	4G signal strength. The icon is displayed only when a 4G SIM card is installed.
F	Time zone of the plant
G	Weather condition of the plant and data refreshing time

Energy statistics

View the revenue brought by and the key energy data of the system.

Daily yield 0 kWh Total: 111.8 kWh	Daily charge 1.1 kWh Total: 18.73 kWh	Daily discharge 8.1 kWh Total: 18.07 kWh	Daily consumed 3 kWh Total: 9204 kWh
--	---	--	--

Figure 6-4 Energy data

Table 6-3 Energy data parameter description

Parameter	Description
Daily yield	Amount of energy that PV panels have generated on the day
Total yield	Total amount of energy that PV panels have generated
Daily charge	Amount of energy that has been charged into the battery on the day
Total charge	Total amount of energy that has been charged into the battery cluster
Daily discharge	Amount of energy that the battery has discharged on the day
Total discharge	Total amount of energy that the battery has discharged
Daily consumed	Amount of energy that the load in the system has consumed on the day
Total consumed	Total amount of energy that the load in the system has consumed

Plant information



Figure 6-5 Plant info

Table 6-4 Plant info description

Parameter	Description
Plant address	Address of the plant
ESS Size (kWh)	Capacity of energy storage system
PV Capacity (kWp)	Maximum power output of the PV
Create time	Time of establishment of the plant

System selection

The EMS1000 PRO can be connected to multiple cabinets, and the energy flow of the entire system or a subsystem can be displayed through system selection.

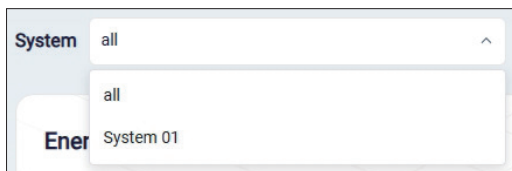

Figure 6-6 System selection

Energy flow

View the energy flow among the four major components of the system, and the specific real-time energy data of each component.

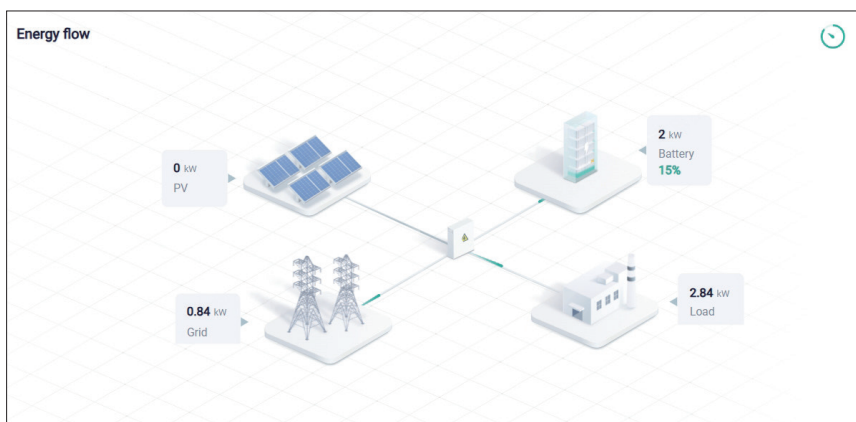

Figure 6-7 Energy flow

Table 6-5 Energy flow parameter description

Component	Parameter	Description
PV	PV Data	Amount of power that the PV panels generate in real time
Battery	<ul style="list-style-type: none"> Battery charge power Battery discharge power 	Amount of power that is charged into or discharges from the battery in real time
	SOC	Battery state of charge, in %
Grid	<ul style="list-style-type: none"> Grid export power Grid import power 	Displays the supplied power or feed-in power of the grid side in the system

Component	Parameter	Description
Load	Load power	Amount of power that the load is consuming in real time

Running status

Quickly view the running status of the grid-connected meter and devices in each cabinet that EMS1000 PRO manages. This helps you to grasp the overall operation of the entire system the moment you log in to the webpage.

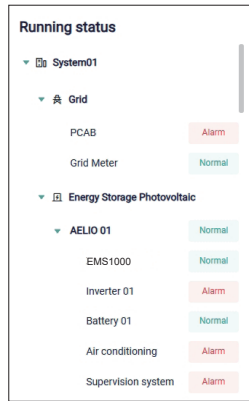

Figure 6-8 Running status

Running line chart

View the running data of the inverter power, load power, battery charging and discharging power, Battery SOC and grid-connected meter power in line chart so that you can understand the changes in the energy of each component more easily and conveniently.

Click on the icon below to select the running line chart you want to view, and you can also hover the mouse on the line chart to view the data on a specific moment.

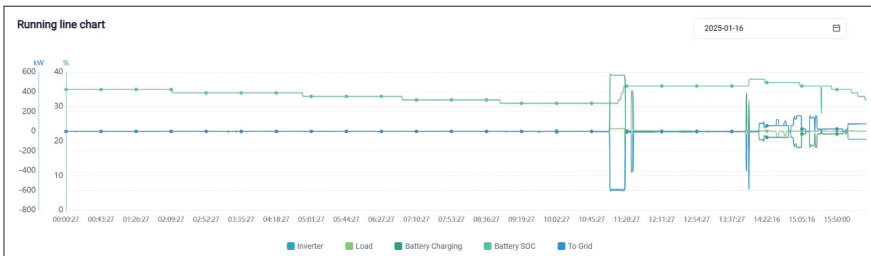

Figure 6-9 Running line

6.5 Device List

Device list displays the device information of the EMS1000, meter, and AC Switching Cabinet connected to the EMS1000 PRO.

6.5.1 Adding Devices

EMS1000 PRO supports adding inverters and meters manually on the webpage. You can add inverters through Modbus RTU, add meters through Modbus RTU or DLT/645.

NOTICE!

Adding device is only available for Admin account.

Step 1: Select **Device list** > **+ Device addition**.

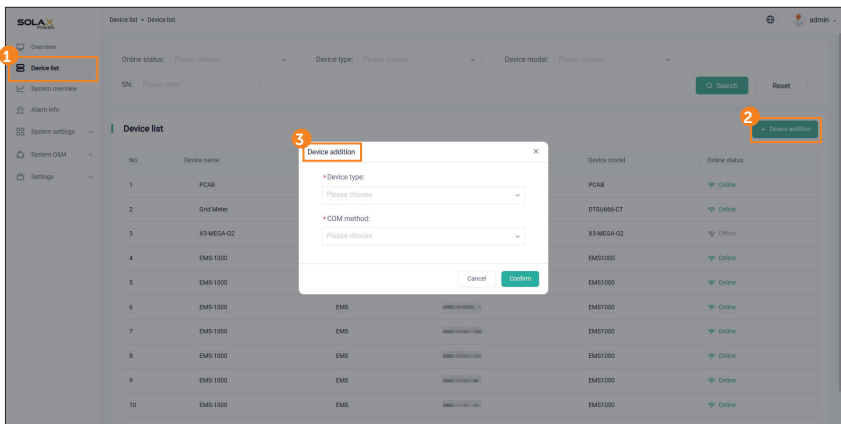

Figure 6-10 Adding devices

Step 2: On **Device addition** pop-up, select the **device type** and **COM method**, enter the required parameters, and then click **Confirm**.

- Adding inverter to the system through Modbus RTU

Currently, inverters that support the Modbus RTU protocol need to be manually added to EMS1000 RPO.

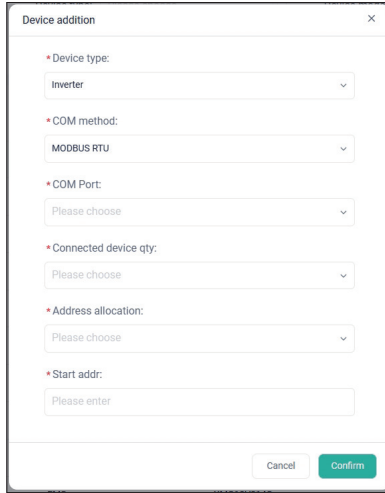

Figure 6-11 Adding inverter through Modbus RTU

Table 6-6 Adding device parameter description

Parameter	Value Range	Description
COM port	1-2&4-7	Number of RS485 terminal of EMS1000 PRO that the inverter is connected to. For example, if the inverter is connected to the 7th RS485 terminal of the Device, the Serial Num is 7.
Connected device qty	1-20	Number of inverters that EMS1000 PRO will be connected to. Up to 20 inverters can be connected.
Address allocation	<ul style="list-style-type: none"> • Manual • Auto 	<ul style="list-style-type: none"> • Auto: Select this method when the inverter supports Modbus RTU automatic address allocation. EMS1000 PRO will automatically assign and recognize an RTU address for your inverter. • Manual: Select this method when the inverter does not support Modbus RTU automatic address allocation. In this case, you will need to manually modify the Modbus address.
Start addr	/	The minimal Modbus address For manual address allocation, enter the minimal address that is configured for the inverter.

- Adding meter to the system through Modbus RTU

Currently, meters that support the Modbus RTU protocol need to be manually added to EMS1000 RPO.

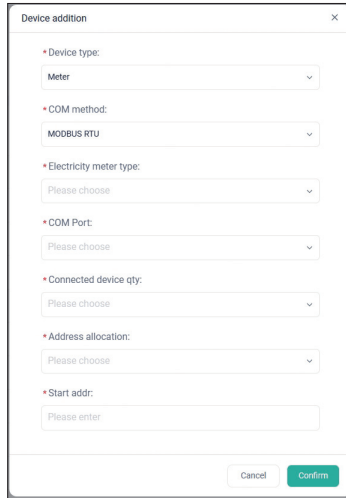

Figure 6-12 Adding meter through Modbus RTU

Table 6-7 Adding device parameter description

Parameter	Value Range	Description
Electricity meter type	Battery Total	Type of meters that EMS1000 PRO will be connected to. Currently, only energy storage meters can be added
COM port	1-254-7	Number of RS485 terminal of EMS1000 PRO that the meter is connected to. For example, if the meter is connected to the 6th RS485 terminal of the Device, the Serial Num is 6.
Connected device qty	1	Number of meters that EMS1000 PRO will be connected to.
Address allocation	<ul style="list-style-type: none"> • Manual • Auto 	<ul style="list-style-type: none"> • Auto: Select this method when the meter supports Modbus RTU automatic address allocation. EMS1000 PRO will automatically assign and recognize an RTU address for your meter. • Manual: Select this method when the meter does not support Modbus RTU automatic address allocation. In this case, you will need to manually modify the Modbus address.
Start addr	/	The minimal Modbus address For manual address allocation, enter the minimal address that is configured for the meter.

- Adding meter to the system through DLT/645

Currently, meters that support the DLT/645 protocol need to be manually added to EMS1000 RPO.

Choose the number of RS485 terminal of EMS1000 PRO that the meter is connected to, only 1-2&4-7 can be selected.

The 'Device addition' dialog box is shown with the following details:

- Device type: Meter
- COM method: DLT/645
- COM Port: Please choose

Figure 6-13 Adding meter through DLT/645

6.5.2 Viewing Devices

Log in to the webpage, and then click **Device list**.

The 'Device list' page displays the following table of devices:

No.	Device name	Device type	SN	Device model	Online status
1	PCAB	PCAB	[REDACTED]	PCAB	Online
2	Grid Meter	Meter	[REDACTED]	DTSM66-CT	Online
3	X3-MEGA-G2	Inverter	[REDACTED]	X3-MEGA-G2	Offline
4	EMS-1000	EMS	[REDACTED]	EMS1000	Online
5	EMS-1000	EMS	[REDACTED]	EMS1000	Online
6	EMS-1000	EMS	[REDACTED]	EMS1000	Online
7	EMS-1000	EMS	[REDACTED]	EMS1000	Online
8	EMS-1000	EMS	[REDACTED]	EMS1000	Online
9	EMS-1000	EMS	[REDACTED]	EMS1000	Online
10	EMS-1000	EMS	[REDACTED]	EMS1000	Online

Figure 6-14 Viewing device information

Device information includes device name, device type, serial No., device model and online/offline status. You can set the number of devices to be displayed per page to 10, 20, 30, 40 and 50, and directly enter the page number to go to a defined page.

6.5.3 Searching for Devices

Search for devices by SN of the device.

Step 1: Log in to the webpage, and then click **Device List**.

Step 2: Set the search conditions, and then click **Search**.

The search results will be displayed on **Device list** below.

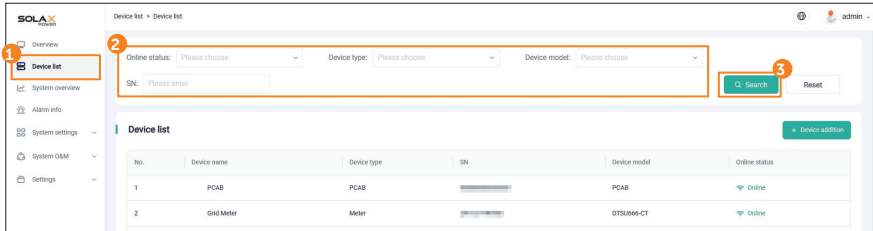

Figure 6-15 Searching for devices

Related operation:

Click **Reset** to clear the search conditions.

6.6 System Overview

In this menu, devices in the system are arranged into a device tree. You can view the detailed information, historical data and other information of each device, and edit the device information.

NOTICE!

The system structure and its affiliated devices mentioned in this manual are for reference only.

System architecture

EMS1000 PRO is on the first tier, managing all devices that are connected to it. These devices are further divided into the grid side, energy storage photovoltaic or energy storage, and solar. You can click ► or ▼ to unfold or fold the sub devices, and enter the device name in the search box to search for a certain device.

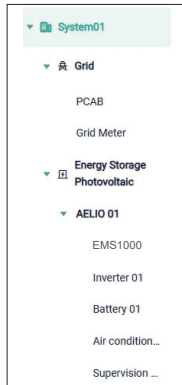

Figure 6-16 System architecture

Refreshing data

The system data is refreshed every 1 minute by default. You can set the data refreshing interval to 1, 3 or 5 minutes as needed, or click **Refresh** to manually update the system data at any time. The latest data refreshing time will be displayed.

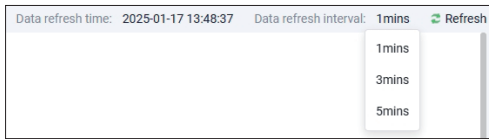

Figure 6-17 Refreshing data

6.6.1 EMS1000 PRO

EMS1000 PRO is at the top of the device tree, managing all devices that are listed under it. In the menu of EMS1000 PRO, you can view the information on the Device, the system data and wiring diagram.

Real-time data

View the image, information and terminal status of EMS1000 PRO, and its communication status with SolaXCloud platform.

Log in to the webpage, and then select **System overview > EMS1000 PRO > Real-time data**.

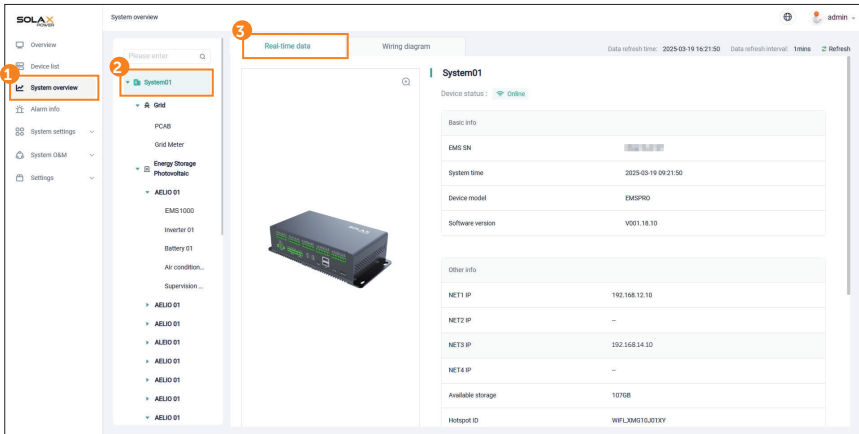

Figure 6-18 Device detailed information

Other info																																					
NET1 IP	192.168.12.10																																				
NET2 IP	-																																				
NET3 IP	192.168.14.10																																				
NET4 IP	-																																				
Available storage	106GB																																				
Hotspot ID	WiFi_XMG10J01XY																																				
Hotspot IP Address	192.168.10.10																																				
DI Status	<table border="1"> <thead> <tr> <th>DI 1</th><th>DI 2</th><th>DI 3</th><th>DI 4</th><th>DI 5</th><th>DI 6</th><th>DI 7</th><th>DI 8</th><th>DI 9</th> </tr> </thead> <tbody> <tr> <td>0</td><td>0</td><td>0</td><td>0</td><td>0</td><td>0</td><td>0</td><td>0</td><td>1</td> </tr> <tr> <th>DI 10</th><th>DI 11</th><th>DI 12</th><th>DI 13</th><th>DI 14</th><th>DI 15</th><th>DI 16</th><th>DI 17</th><th>DI 18</th> </tr> <tr> <td>1</td><td>1</td><td>0</td><td>0</td><td>0</td><td>0</td><td>0</td><td>0</td><td>0</td> </tr> </tbody> </table>	DI 1	DI 2	DI 3	DI 4	DI 5	DI 6	DI 7	DI 8	DI 9	0	0	0	0	0	0	0	0	1	DI 10	DI 11	DI 12	DI 13	DI 14	DI 15	DI 16	DI 17	DI 18	1	1	0	0	0	0	0	0	0
DI 1	DI 2	DI 3	DI 4	DI 5	DI 6	DI 7	DI 8	DI 9																													
0	0	0	0	0	0	0	0	1																													
DI 10	DI 11	DI 12	DI 13	DI 14	DI 15	DI 16	DI 17	DI 18																													
1	1	0	0	0	0	0	0	0																													
DO Status	<table border="1"> <thead> <tr> <th>DO 1</th><th>DO 2</th><th>DO 3</th><th>DO 4</th><th>DO 5</th><th>DO 6</th><th>DO 7</th><th>DO 8</th> </tr> </thead> <tbody> <tr> <td>0</td><td>0</td><td>0</td><td>0</td><td>0</td><td>0</td><td>0</td><td>0</td> </tr> </tbody> </table>	DO 1	DO 2	DO 3	DO 4	DO 5	DO 6	DO 7	DO 8	0	0	0	0	0	0	0	0																				
DO 1	DO 2	DO 3	DO 4	DO 5	DO 6	DO 7	DO 8																														
0	0	0	0	0	0	0	0																														

Figure 6-19 Other information

Table 6-8 EMS1000 PRO parameter description

Parameter	Description
Device status	The connection status between EMS1000 PRO and SolaXCloud platform <ul style="list-style-type: none"> • Online: EMS1000 PRO is connected to SolaXCloud platform • Offline: EMS1000 PRO is disconnected from SolaXCloud platform
NET3 IP	IP address that is used to access EMS1000 PRO webpage when EMS1000 PRO is connected to the computer through a network cable. It is 192.168.14.10 by default.
Hotspot ID	Name of EMS1000 PRO hotspot

Parameter	Description
Hotspot IP Address	IP address that is used to access EMS1000 PRO webpage when EMS1000 PRO is connected to the computer through its hotspot. It is 192.168.10.10 by default.
DI status DO status	Displays the connection status of each DI and DO port

System architecture

View the system wiring diagram involving the subordinate EMS1000 and EMS1000 PRO connected to the EMS1000 PRO.

Log in to the webpage, and then select **System overview > EMS1000 PRO > Wiring diagram**.

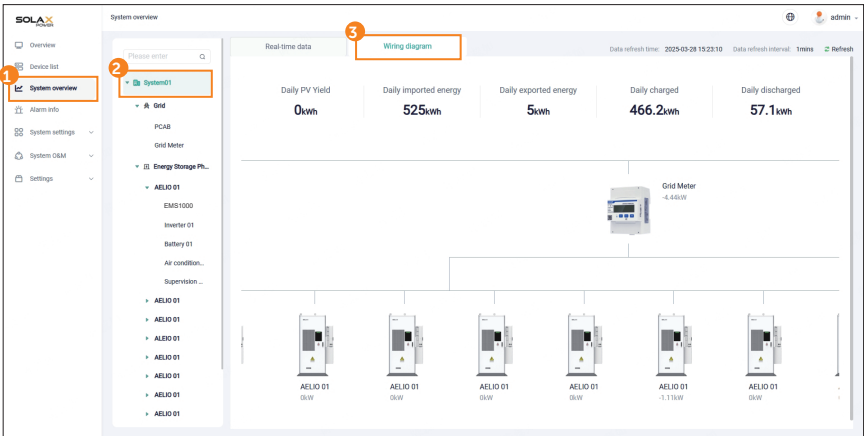

Figure 6-20 System wiring diagram

Viewing system information

View the core power data of the system, and the system wiring diagram involving the grid-connected meter, cabinet, external inverter and load.

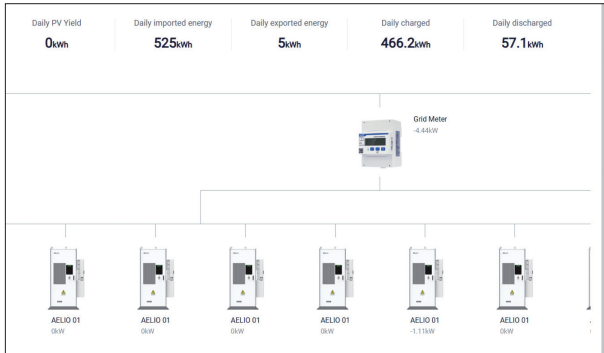

Figure 6-21 Sub system wiring diagram

Table 6-9 Sub system architecture description

Parameter	Description
Daily PV yield	Amount of energy that PV panels have generated on the day
Daily imported energy	Amount of power that the system in the cabinet imports from the grid on the day
Daily exported energy	Amount of power that the system in the cabinet exports to the grid on the day
Daily charged	Amount of power that has been charged into the battery on the day
Daily discharged	Amount of power that the battery has discharged on the day

Viewing cabinet information

You can also click the cabinet image to view more details on the it, including its sub devices and related device data.



Figure 6-22 Cabinet architecture

Table 6-10 Cabinet information description

Parameter	Description
Supervision system	Operation status of the supervision system inside the cabinet
Air conditioning	Operation status of the air conditioner, and the temperature and relative humidity data inside the cabinet
Cabinet	Displays the output power of the inverter in the cabinet
Inverter	Displays the active and reactive power of the inverter
BMS	Displays the battery SOC, battery voltage and current

Viewing battery information

On the information page of a single cabinet, you can continue to click the BMS image to view key cell information on the battery cluster. This helps you keep the battery status in control for the long-term stable operation of the system.

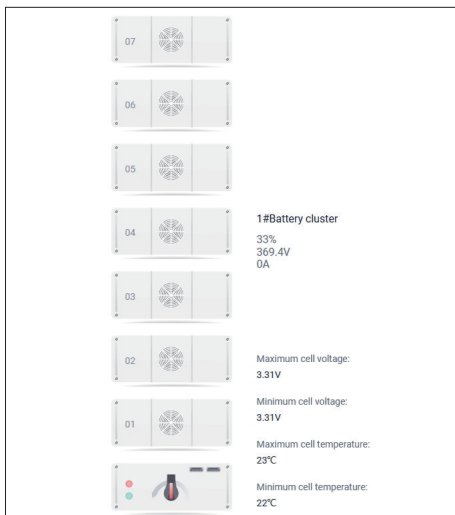

Figure 6-23 Viewing battery cluster information

Table 6-11 Battery cluster parameter description

Item	Description
Maximum cell voltage	The highest cell voltage among all cells of the battery packs
Minimum cell voltage	The lowest cell voltage among all cells of the battery packs
Maximum cell temperature	The highest cell temperature among all cells of the battery packs
Minimum cell temperature	The lowest cell temperature among all cells of the battery packs

6.6.2 AC Switching Cabinet

AC Switching Cabinet series is designed to work with AELIO and TRENE energy storage systems for on-grid and off-grid switch.

Device details

View the online/offline status, SN and model of the AC Switching Cabinet, real-time data of each phase collected by the AC Switching Cabinet and the status of the sensors.

Log in to the webpage, and then select **System overview > PCAB > Device details**.

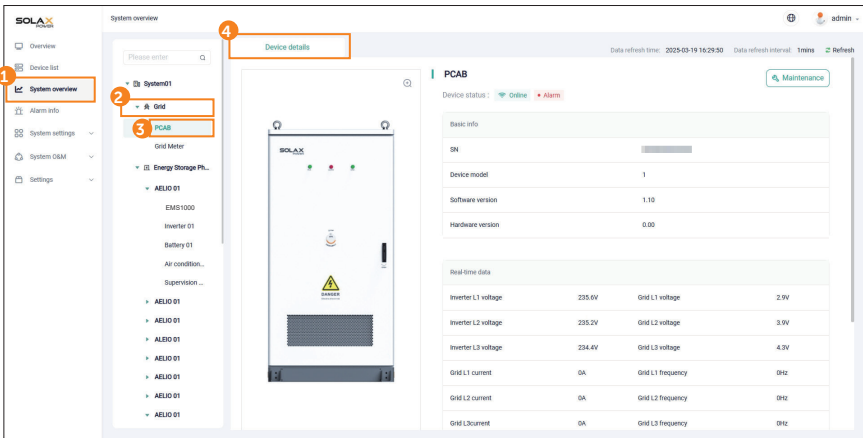

Figure 6-24 Viewing AC Switching Cabinet information

You can also click **Maintenance** on the upper-right corner to view more details on the AC Switching Cabinet.

Device info			
Device name	PCAB	Device SN	[REDACTED]
Device model	1	Software version	1.10
Hardware version	0.00	Connect type	MODBUS-TCP
IP	192.168.12.75	Add time	2024-12-20 11:51:58

Figure 6-25 AC Switching Cabinet information on maintenance page

Maintaining AC Switching Cabinet

You can upgrade the AC Switching Cabinet firmware and edit the name of the AC Switching Cabinet if needed.

Log in to the webpage, and then select **System overview > Grid > PCAB > Maintenance**.

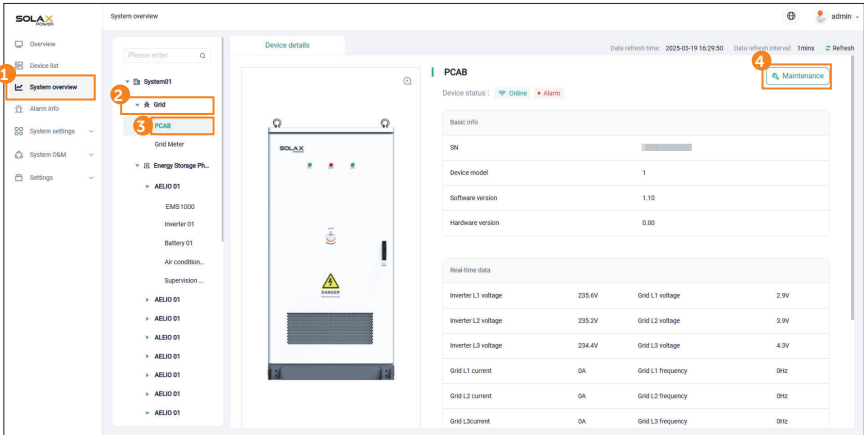

Figure 6-26 Maintaining AC Switching Cabinet

- Upgrading the AC Switching Cabinet firmware

NOTICE!

The AC Switching Cabinet firmware upgrade function is only available for the admin account.

Under **Device operation**, click **Firmware upgrade**, click **Choose file**, import the update firmware file, and then click **Upgrade**.

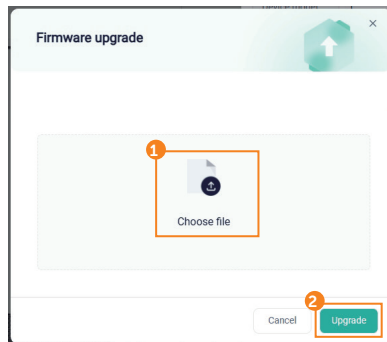

Figure 6-27 Upgrading the AC Switching Cabinet firmware

- Editing the Device Name

Under **Device operation**, click **Edit device**, enter a new name on the pop-up for the AC Switching Cabinet, and then click **Confirm**.



Figure 6-28 Editing the meter name

6.6.3 Grid Meter

The grid meter refers to the grid-connected metering device that is connected to EMS1000 PRO for monitoring the power flow of the system. Currently, three types of metering devices are supported: DTSU666-CT meter, Wi-BR DTSU666-CT meter, and CT.

Viewing real-time data

View the running status and basic information of the metering device, and the real-time power-related data of the entire system that the device detects.

Log in to the webpage, select **System overview > Grid > Grid meter > Real-time data**.

- DTSU666-CT

View the online/offline status, SN and model of the meter, and the system power data collected by the meter, including the energy imported from and exporting to the grid, and other data on each phase.

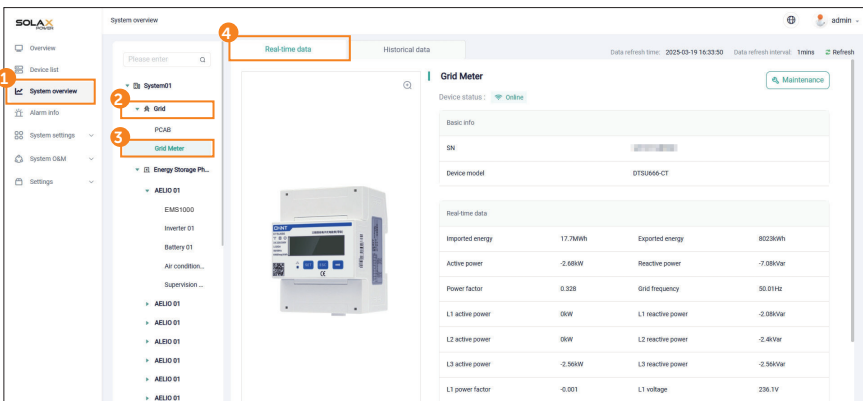

Figure 6-29 Viewing real-time data of DTSU666-CT

You can also click **Maintenance** on the upper-right corner to view more details on the grid-connected metering device.

Device info			
Device name	Grid Meter	Device SN	[REDACTED]
Device model	DTSU666-CT	Connect EMS Registration Number	[REDACTED]
Electricity meter type	Grid Meter	Add time	2025-01-08 11:21:01

Figure 6-30 Meter information on the Maintenance page

Table 6-12 Meter information on the Maintenance page

Data Type	Description
Device SN	SN of the meter
Device model	Model of the meter
Connect EMS registration number	Registration No. of the EMS1000 PRO that the meter is connected to
Electricity meter type	Grid-tied meter
Add time	Time that the meter establishes communication with EMS1000 PRO

Maintaining grid meter

You can edit the name of the meter, perform Meter/CT check and enable communication loss shutdown if needed.

Login to the webpage, and then select **System overview > Grid > Grid meter > Real-time data > Maintenance**.

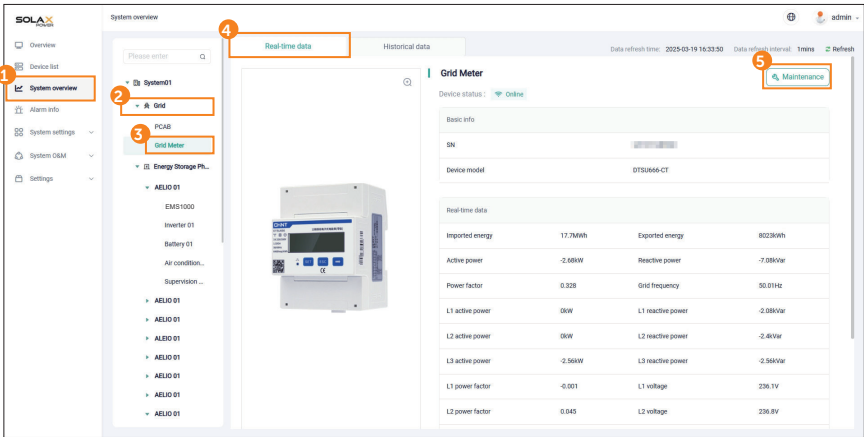

Figure 6-31 Maintaining the grid meter

- Editing the device name

Under **Device operation**, click **Edit device**, enter a new name on the pop-up for the meter, and then click **Confirm**.

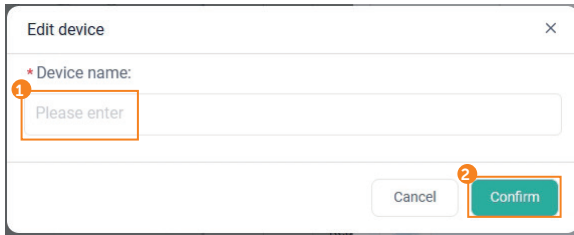

Figure 6-32 Editing the meter name

- Communication shutdown loss

Enable this function to automatically shut down the system when EMS1000 PRO loses communication with the grid meter. This is to ensure that the system power flow is kept in control, especially in the on-grid mode. The function is enabled by default.

If you manually disable it, the system can remain normal operation, but certain functions might be affected, such as zero output, demand control, data statistics and more.

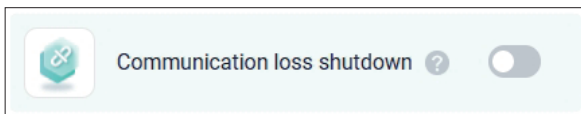

Figure 6-33 Enabling communication loss shutdown

- **Reverse Setting**

Enable the function when the system power data is reverse to the actual power flow. This feature allows the meter to automatically rectify the system power data without need for physical rewiring. It is disabled by default.

NOTICE!

This function is only available for meter models.

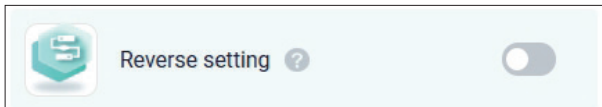

Figure 6-34 Enabling reverse setting

Viewing historical data

You can search for multiple types of data that the meter collected, including the voltage, current, and active power of each phase, and the total active, reactive and apparent power of the three phases, grid frequency, and the imported and exporting power of the entire system. The search results will be displayed in the line chart.

Step 1: Log in to the webpage, and then select **System overview > Grid > Grid meter > Historical data**.

Step 2: Set the **Time**, select the **Indicators**, and then click **Check**.

Up to 4 search indicators can be selected at one time, and the results will be displayed in lines of different colors in the line chart.

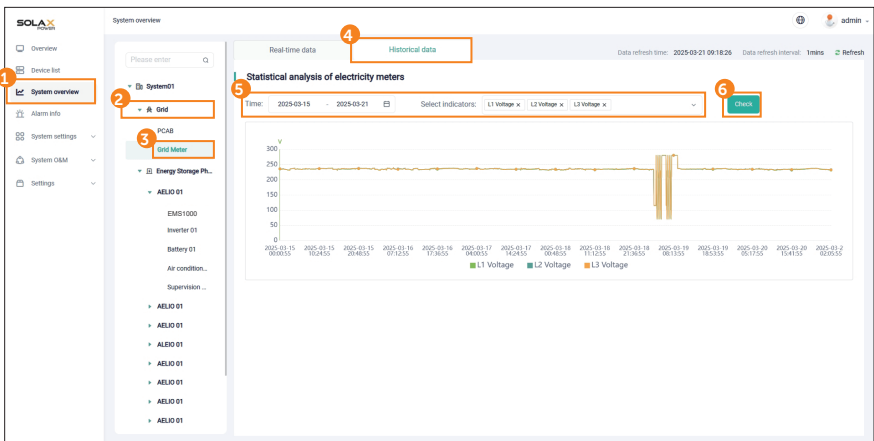

Figure 6-35 Searching for historical data

6.6.4 Cabinet

NOTICE!

The cabinet system name might be Energy Storage or Energy Storage Photovoltaic depending on the inverter type. For AELIO system, the cabinet system name is Energy Storage Photovoltaic; For TRENE system, the cabinet system name is Energy Storage.

Viewing cabinet information

View the running status and basic information of the cabinet, information on the embedded IO module, and real-time data of the battery system.

Login to the webpage, and then select **System overview >> Energy Storage Photovoltaic/ Energy Storage > Cabinet**.

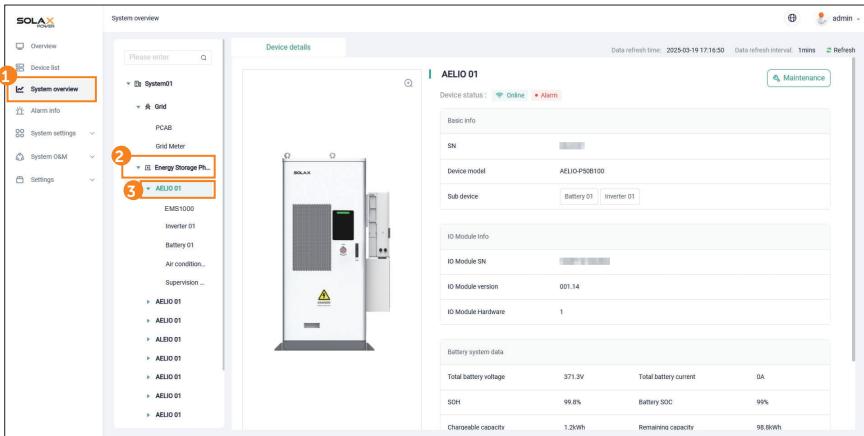

Figure 6-36 Cabinet information

Table 6-13 Real-time data description

Data Type	Parameter	Description
Device status	/	Displays the online/offline status of the battery, and the operation status of devices in the cabinet.
Basic info	Sub device	Devices that are included in the cabinet for management

Data Type	Parameter	Description
Battery system data	Total battery voltage	Total voltage of the battery cluster that is connected to cabinet
	Total battery current	Total voltage of the battery cluster that is connected to cabinet
	SOH	Health status of the battery cluster that is connected to cabinet
	Battery SOC	SOC of the battery cluster at the time
	Chargeable Capacity	Amount of power that can be charged into the battery cluster before it is fully-loaded
	Remaining Capacity	Amount of power that the battery cluster can discharge
	Total charge	Total amount of power that has been charged into the battery cluster by the time
	Total discharge	Total amount of power that the battery cluster has discharged by the time
	Cycle	Number of times that the battery cluster has been fully charged and discharged. A full charge and discharge make a cycle.
Insulation Resistance	Equivalent impedance between the battery cluster and PE point of the device enclosure	

You can also click **Maintenance** on the upper-right corner to view more information on the cabinet.

Device info			
Device name	AELIO 01	Device SN	██████
Device model	AELIO-P50B100	Software version	001.14
Hardware version	1	Add time	2024-12-02 14:40:36

Figure 6-37 Cabinet information on the Maintenance page

Table 6-14 Meter information on the Maintenance page

Data Type	Description
Add time	Time that the sub devices in the cabinet complete pairing

Maintaining cabinet

You can upgrade the firmware of the IO module in the cabinet and edit the cabinet name if needed.

Log in to the webpage, and then select **System overview > Energy Storage Photovoltaic/ Energy Storage > Cabinet > Device details > Maintenance**.

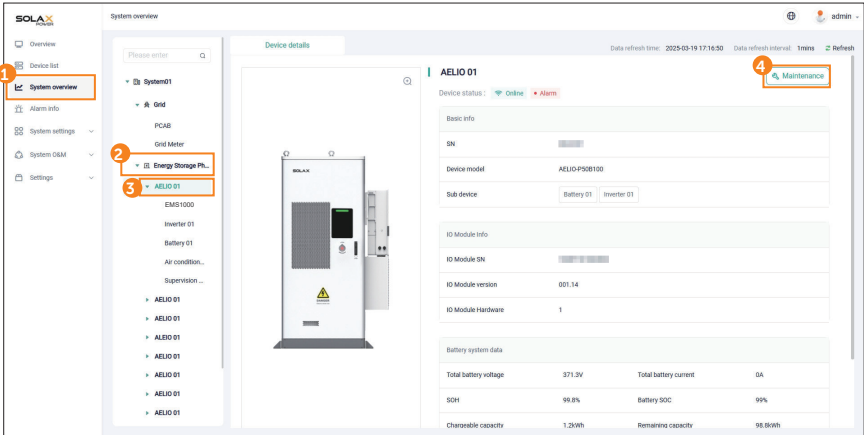

Figure 6-38 Maintaining the cabinet

- Upgrading the IO firmware

NOTICE!

The IO firmware upgrade function is only available for the admin account.

Under **Device operation**, click **Firmware upgrade**, click **Choose file**, import the update firmware file, and then click **Upgrade**.

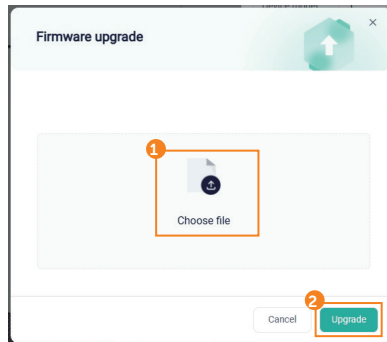

Figure 6-39 Upgrading IO firmware

- Editing the cabinet name

Click **Maintenance > Edit device**, enter a new name for the cabinet, and then click **Confirm**.

Figure 6-40 Editing cabinet name

6.6.5 Inverter

View the information, real-time data and historical data of the inverter.

Viewing real-time data

View the working status of the inverter, basic information on the inverter, and the related power data of the PV system.

Log in to the webpage, and then select **System overview > Energy Storage Photovoltaic/Energy Storage > Cabinet > Inverter > Real-time data**.

NOTICE!

The **Real-time data** page of the inverter might vary depending on the model of the inverter. X3-AELIO and X3-TRENE-100K models are used for example to demonstrate the different page layout.

- X3-AELIO

You can view the online/offline status, system switch on/off status, and working condition of the inverter. The real-time power data of the system is divided into multiple dimensions, such as PV data, AC data, EPS data, battery data and more. You can click the data type to view specific statistics.

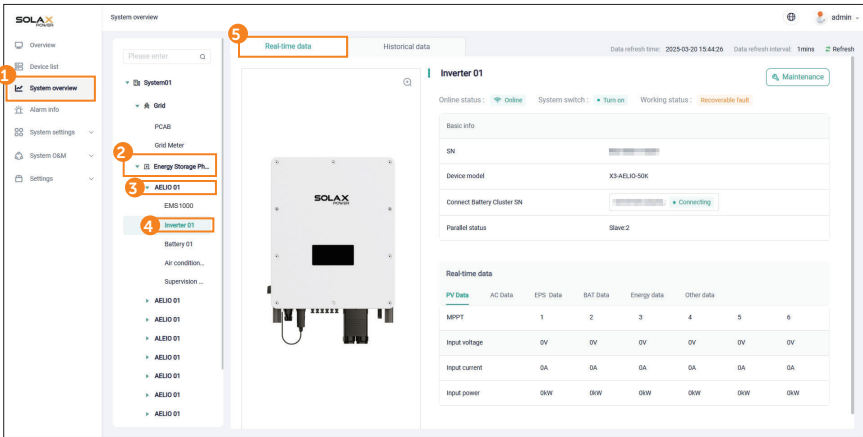

Figure 6-41 Viewing real-time data of the X3-AELIO inverter

Table 6-15 Inverter data description

Data type	Parameter	Description
Working condition	Online status	Communication status of the inverter and EMS1000 PRO
	System switch	On/off status of the inverter system switch
	Working status	Whether the inverter is running normally
Basic info	Connect battery cluster SN	SN of the battery cluster that the inverter is connected to Connecting status of the battery cluster
	Parallel status	Whether the inverter is EPS connected to other inverters or not; if yes, the role of the inverter in the connection will be displayed, which can be master or slave. If not, the inverter is free.
Real-time data	PV data	The input voltage, current and power of each MPPT
	AC data	The power data from the grid into the inverter, such as total power, voltage, current and more of each phase
	EPS data	The power data of the inverter EPS side, such as the different types of power, voltage, frequency of each phase
	BAT data	The voltage, current and power of each battery cluster that has been connected to the inverter
	Energy data	Daily and total inverter input and output, and daily and total yield power of the inverter and EPS
	Other data	Includes inverter radiator temperature and ambient temperature

You can also click **Maintenance** on the upper-right corner to view more details on the inverter.

Device info			
Device name	Inverter 01	Device SN	██████████
Device model	X3-AELIO-50K	ARM	006.01
DSP	007.02	Connect type	MODBUS-RTU
COM Port	7	Address	1
Add time	2024-12-02 14:57:18		

Figure 6-42 X3-AELIO information on Maintenance page

Table 6-16 X3-AELIO information on the Maintenance page

Data Type	Description
Connect type	Communication protocol through which the inverter is connected to EMS1000 PRO: MODBUS-RTU.
COM port	No. of the COM port
Address	Modbus address of the inverter for communication
Add time	Time that the inverter establishes communication with EMS1000

• X3-TRENE-100K

You can view the online/offline and operation status of the inverter, its basic information and related power data.

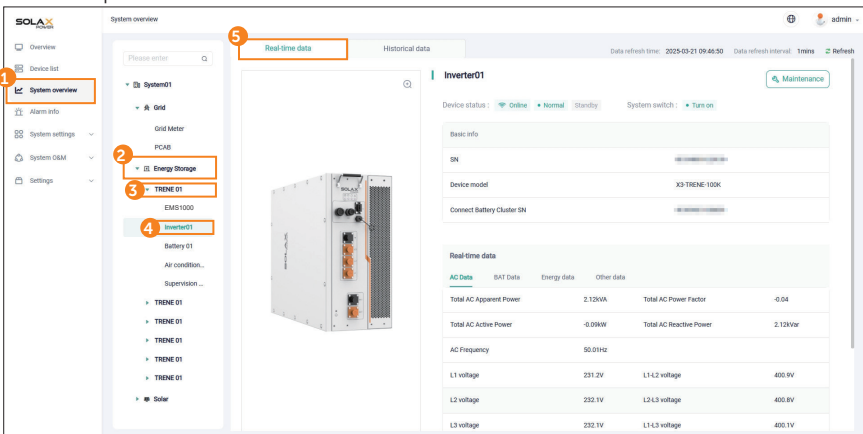

Figure 6-43 Viewing real-time data of X3-TRENE-100K

Table 6-17 Inverter data description

Data Type	Parameter	Description
Working condition	Device status	Includes the online/offline status and operation status of the inverter
	System switch	On/off status of the inverter system switch
Basic Info	Connect battery cluster SN	SN of the battery cluster
Real-time data	AC data	Displays the data from the grid into the inverter, such as apparent power, active and reactive power, and voltage, line voltage, current of each phase
	BAT data	Includes inverter BAT voltage, current and power
	Energy data	Daily and total inverter charge and discharge
	Other data	Includes inverter internal temperature, balance bridge temperature, inverter module temperature, insulation resistance, fan speed and external fan speed

You can also click **Maintenance** on the upper-right corner to view more details on the inverter.

Device info			
Device name	Inverter01	Device SN	[REDACTED]
Device model	X3-TRENE-100K	Software version	7.03
ARM	7.00	DSP	7.03
Slave DSP Version	7.02	Connect type	MODBUS-TCP
Address	[REDACTED]	Add time	2024-11-19 13:26:34

Figure 6-44 X3-TRENE-100K information on Maintenance page

Table 6-18 X3-TRENE-100K information on the Maintenance page

Data Type	Description
Connect type	Communication protocol through which the inverter is connected to EMS1000 PRO: MODBUS-TCP.
IP	IP address of the inverter
Add time	Time that the inverter establishes communication with EMS1000 PRO

Maintaining the inverter

You can upgrade the firmware and edit the inverter name of the inverter if needed.

Log in to the webpage, and then select **System overview > Energy Storage Photovoltaic/ Energy Storage > Cabinet > Inverter > Real-time data > Maintenance**.

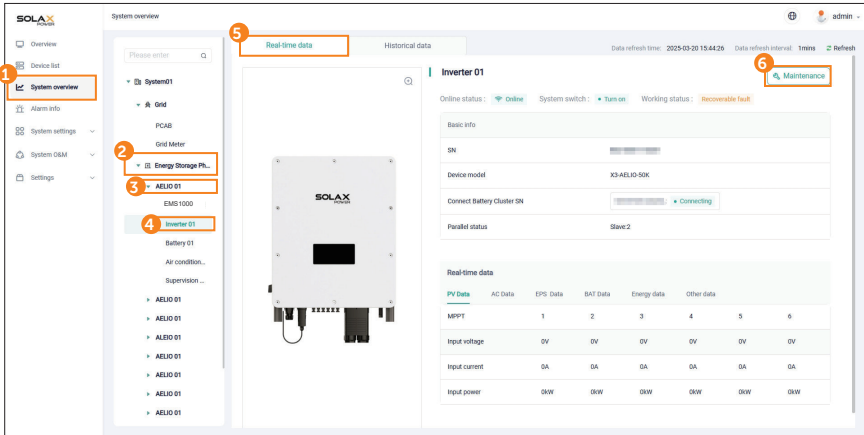

Figure 6-46 Maintaining the inverter

- Upgrading the inverter firmware

NOTICE!

- The inverter firmware upgrade function is only available for the admin account.
- For X3-TRENE-100K, only one type of update file is supported.

Step 1: On **Device maintenance** page, click **Firmware upgrade**.

Step 2: (Optional) On the **Firmware upgrade** pop-up, select **ARM** or **DSP** for **Upgrade module**.

Step 3: Click **Choose file** to import the update firmware file, and then click **Upgrade**.

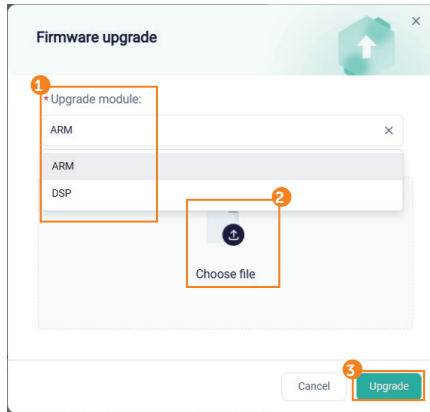

Figure 6-47 Upgrading the inverter firmware

- **Editing the inverter name**

On the **Device maintenance** page, click **Edit device**, enter a new name for the inverter, and then click **Confirm**.

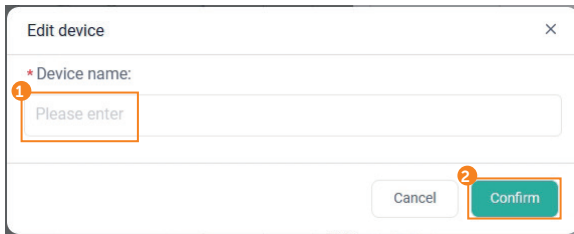

Figure 6-48 Editing the inverter name

- **Turning on or off the inverter**

Select **Maintenance > System ON/System OFF**, and then click **Ok** on the confirmation pop-up.

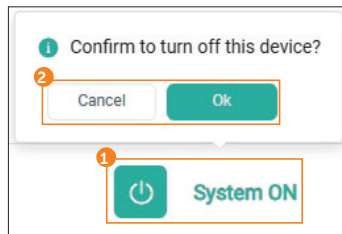

Figure 6-49 Turning on or off the inverter

Viewing historical data

View one or more types of inverter-related power data in the line chart.

- **Inverter statistics**

You can view multiple types of data of the inverter, such as the voltage and current of each phase, frequency, and radiator temperature. The search results are displayed in line chart.

Step 1: Log in to the webpage, and then select **System overview > Energy Storage Photovoltaic/Energy Storage > Cabinet > Inverter > Historical data**.

Step 2: In the **Inverter statistics** section, Set the search duration, select the search indicators from the drop-down list, and then click **Check**.

The maximum time interval is 7 days, and up to 4 items can be selected at one time. The search results will be displayed in lines of different colors in the line chart.

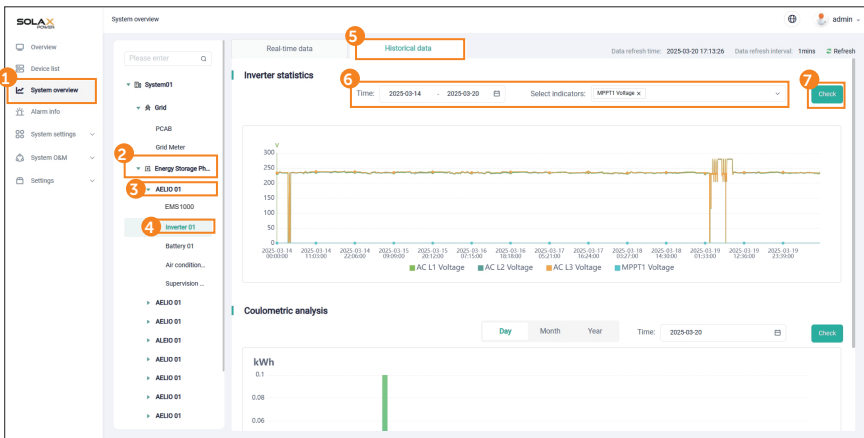

Figure 6-50 Viewing inverter statistics

- **Coulometric analysis**

The charging and discharging data of the inverter can be displayed in bar chart by day, month and year.

Step 1: Select **System Overview > Inverter > Historical data**.

Step 2: In the **Coulometric analysis** section, select **Day, Month** or **Year**, set the specific day, month or year, and then click **Check**.

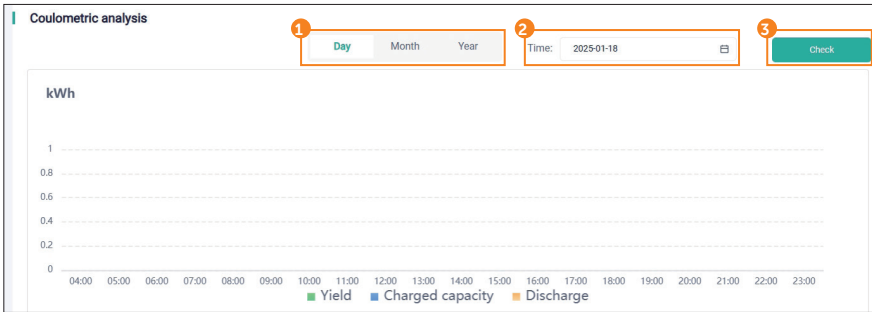

Figure 6-51 Viewing coulometric data

You can also hover the mouse on any time node in the bar chart to view the specific charging, discharging and yielding data.

6.6.6 Battery

View information on the battery cluster, battery packs and battery cells.

Viewing real-time data

View the status, basic information and real-time data of the battery cluster, and key data on the battery packs and cells.

Log in to the webpage, and then select **System overview > Energy Storage Photovoltaic/ Energy Storage > Cabinet > Battery > Real-time data**.

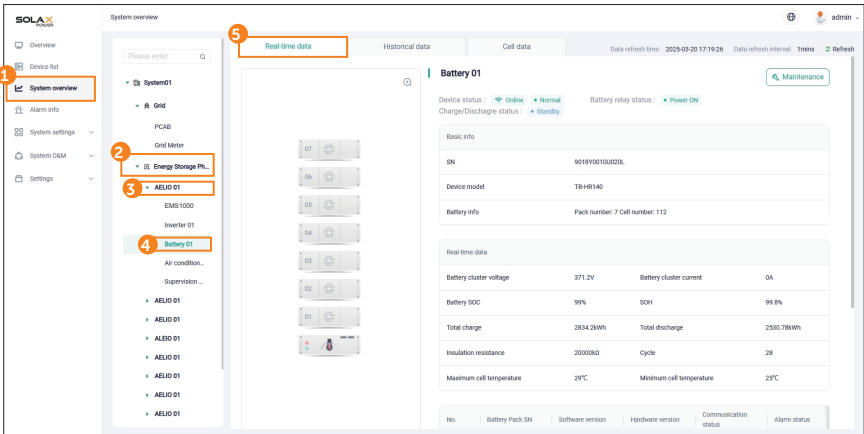

Figure 6-52 Viewing real-time data of the battery cluster

Table 6-19 Battery real-time data description

Data Type	Parameter	Description
Status	Device status	Includes the online/offline status and operation status of the inverter
	Battery relay status	Whether the battery cluster is powered on or off
	Charge/Discharge status	Whether the battery cluster is charging, discharging or idle
Basic info	Battery info	Displays the number of the battery packs and cells of the battery cluster
Real-time data	Battery cluster voltage	Total voltage of the battery cluster
	Battery cluster current	Total voltage of the battery cluster that is connected to cabinet
	Battery SOC	SOC (State of Charge) of the battery cluster at the time
	SOH	Health status of the battery cluster
	Total charge	Total amount of power that has been charged into the battery cluster
	Total discharge	Total amount of power that the battery cluster has discharged
	Insulation resistance	Equivalent impedance between the battery cluster and PE point of the device enclosure
	Cycle	Number of times that the battery cluster has been fully charged and discharged. A full charge and discharge make a cycle.
	Maximum cell temperature	Maximum cell temperature in the battery pack
	Minimum cell temperature	Minimum cell temperature in the battery pack

There is a list of battery pack information, in which you can view the key parameters of each battery pack of the battery cluster. You can draw the bar horizontally on the bottom of the list to view different information.

No.	Battery Pack SN	Software version	Hardware version	Communication status	Alarm status
01		R140CV_001.R00	1	Online	Normal
02		R140CV_001.R00	1	Online	Normal
03		R140CV_001.R00	1	Online	Normal
04		R140CV_001.R00	1	Online	Normal
05		R140CV_001.R00	1	Online	Normal
06		R140CV_001.R00	1	Online	Normal
07		R140CV_001.R00	1	Online	Normal

Figure 6-53 Viewing real-time data of battery packs

Table 6-20 Battery pack information description

Parameter	Description
Battery Pack SN	SN of the battery pack in the battery cluster
Communication status	Communication status between the battery pack and battery cluster
Alarm status	The alarm status of the battery pack
SOC (%)	SOC (State of Charge) of the battery pack at the time
SOH (%)	Health status of the battery pack
Maximum cell temperature	Maximum cell temperature in the battery pack
Minimum cell temperature	Minimum cell temperature in the battery pack
Maximum cell voltage	Maximum cell voltage in the battery pack
Minimum cell voltage	Minimum cell voltage in the battery pack
Anode temperature	The anode temperature of the battery pack
Cathode temperature	The cathode temperature of the battery pack

You can also click **Maintenance** on the upper-right corner to view more details on the battery.

Device info			
Device name	Battery 01	Device SN	██████████
Device model	TB-HR140	HVU SN	██████████
Battery software version	002.01	Battery hardware version	1
HVU Software Version	001.00	HVU Hardware Version	1
Add time	2024-12-02 14:57:18		

Figure 6-54 Battery information on the Maintenance page

Table 6-21 Battery information on the Maintenance page

Parameter	Description
Add time	Time that the battery establishes communication with EMS1000

Maintaining the battery

You can upgrade the firmware and edit the battery name of the battery cluster if needed.

Log in to the webpage, and then select **System overview > Energy Storage Photovoltaic/Energy Storage > Cabinet > Battery > Real-time data > Maintenance**.

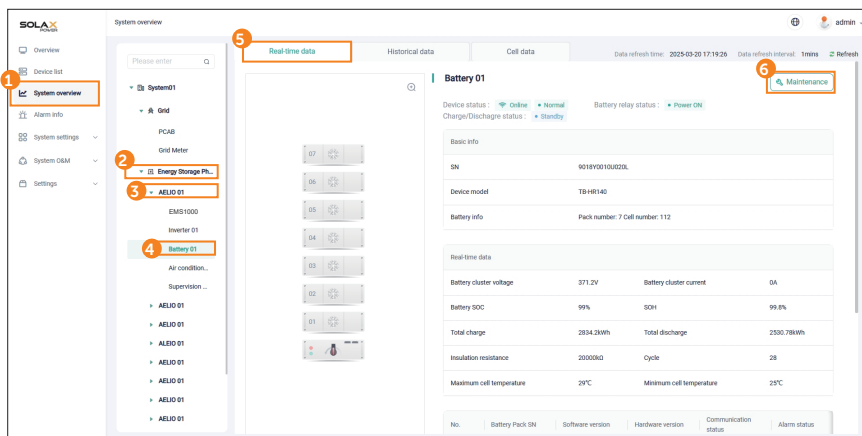

Figure 6-55 Maintaining the battery

- **Upgrading the battery firmware**

NOTICE!

The battery firmware upgrade function is only available for the admin account.

Under **Device operation**, click **Firmware upgrade**, click **Choose file**, import the update firmware file, and then click **Upgrade**.

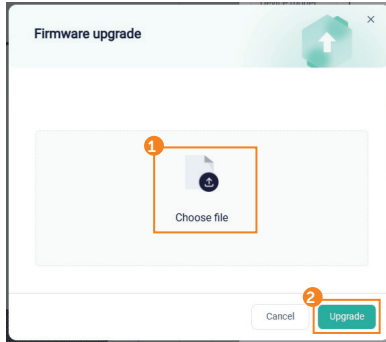

Figure 6-56 Upgrading the battery firmware

- **Editing the battery name**

Click **Maintenance > Edit device**, enter a new name for the cabinet, and then click **Confirm**.

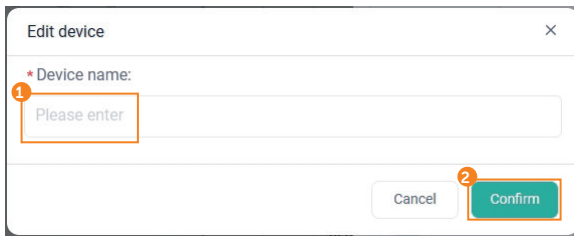

Figure 6-57 Editing the battery name

Viewing historical data

View information on the battery cluster such as the voltage, current, SOC and more.

Step 1: Log in to the webpage, and then select **System overview > Energy Storage Photovoltaic/Energy Storage > Cabinet > Battery > Historical data**.

Step 2: Set the **Time**, select the **Indicators**, and then click **Check**.

The maximum time interval is 7 days, and up to 4 search indicators can be selected at one time. The search results will be displayed in lines of different

colors in the line chart.

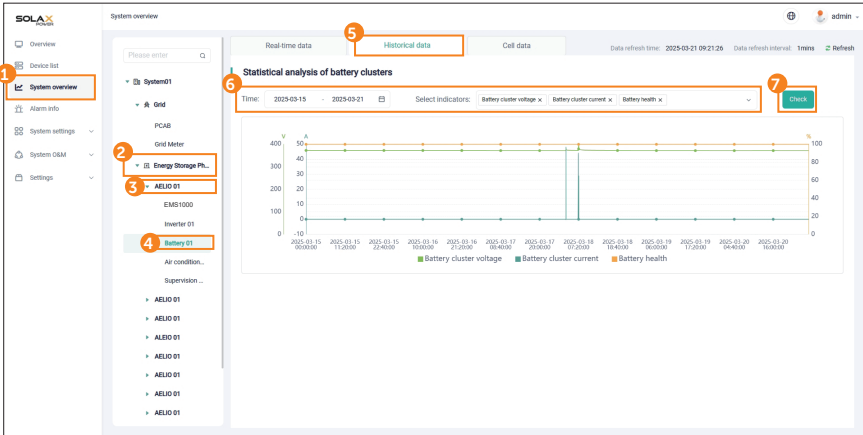

Figure 6-58 Searching for the battery historical data

Viewing cell data

View the cell number, voltage and temperature of the each cell. These data can be displayed in three modes: overview, histogram and sheet.

Log in to the webpage, select **System overview > Energy Storage Photovoltaic/Energy Storage > Cabinet > Battery > Cell data**, and then select the display mode.

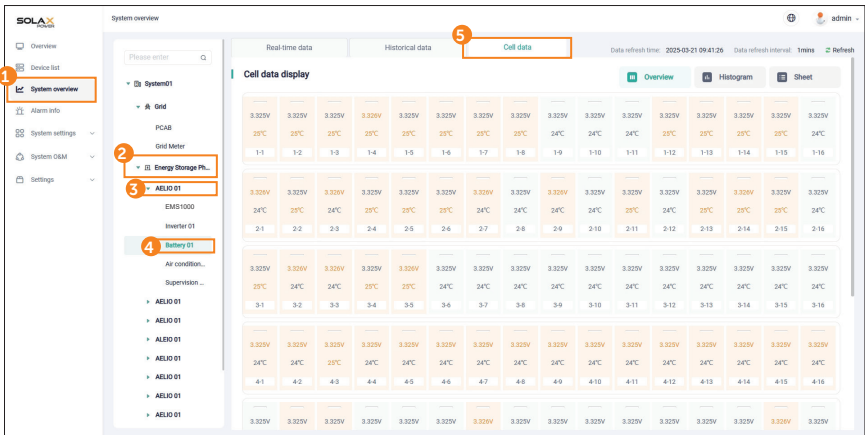

Figure 6-59 Viewing cell data

- **Overview**

In this mode, the voltage, temperature and number of each cell is arranged in a spread-out manner. You can scroll up and down to view these data.



Figure 6-60 Cell data displayed in overview

- **Histogram**

In this mode, the cell voltage and temperature are displayed separately. You need to select a parameter, and then the search results will be displayed in bar chart.

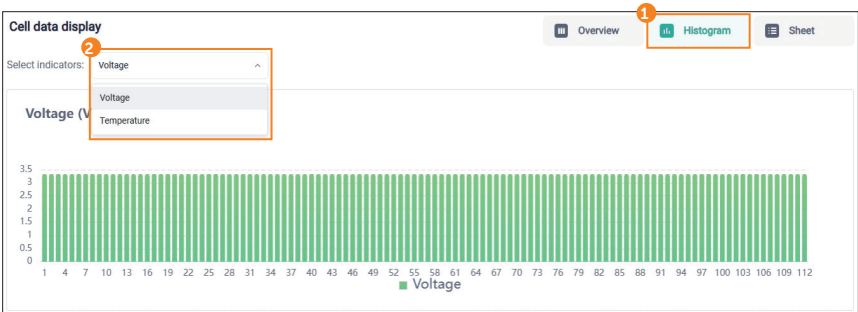

Figure 6-61 Cell data displayed in histogram

- **Sheet**

In this mode, the cell number, voltage, and temperature are displayed in a list. Information of 10 cells are displayed by default, and you can set the number of cells to be displayed per page to 10, 20, 30, 40 and 50, or directly enter the page number to go to a defined page.

No.	Voltage(V)	Temperature(°C)
1	3.331	23
2	3.331	23
3	3.331	23
4	3.331	23
5	3.331	23
6	3.332	23
7	3.332	23
8	3.332	23
9	3.332	23
10	3.331	23

Total: 112 < 1 2 3 4 5 ... 12 > 10 / Page Goto

Figure 6-62 Cell data displayed in sheet

6.6.7 Air Conditioning

View information on the air conditioner, and manually turn on or off it.

NOTICE!

Currently, there are two air conditioner models (2000KP and LZXD-3.5GE) that are installed in different cabinet models, and their parameters are different.

Viewing information

Log in to the webpage, and then select **System overview > Energy Storage Photovoltaic/ Energy Storage > Cabinet > Air conditioning > Device details**.

- 2000KP

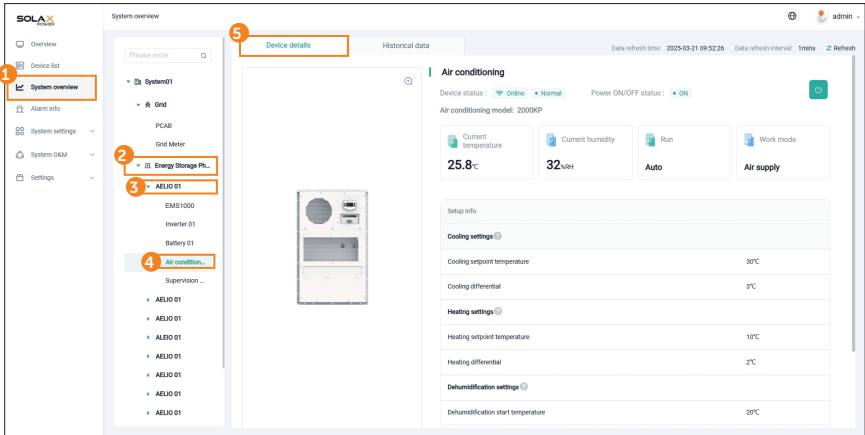

Figure 6-63 Information on 2000KP air conditioner

Table 6-22 Parameter description on 2000KP air conditioner

Data Type	Parameter	Description
Device info	Device status	Includes the online/offline status and operation status of the air conditioner
	Power ON/OFF status	ON/OFF status of the air conditioner
	Air conditioning model	Model of the air conditioner
Real-time info	Current temperature	Real-time ambient temperature inside the cabinet
	Current humidity	Real-time humidity inside the cabinet
	Running mode	Operation mode of the air conditioner, including automatic, forced cooling, forced heating, forced air supply and forced standby
Setup info	Work mode	Real-time running status of the air conditioner, including cooling, heating, air supply and standby
	Cooling settings	Includes the cooling setpoint temperature and cooling differential. The air conditioner start cooling when the temperature is higher than the cooling setpoint temperature + cooling differential, and stop when lower than the cooling setpoint temperature.

Data Type	Parameter	Description
	Heating settings	Includes the heating setpoint temperature and heating differential. The air conditioner start heating when the temperature is lower than the heating setpoint temperature, and stop when higher than the heating setpoint temperature + heating differential.
Setup info	Dehumidification settings	Includes dehumidification start temperature, dehumidification stop temperature, dehumidification start humidity and dehumidification stop humidity. dehumidification is triggered when the following two conditions are met at the same time: 1. The humidity is higher than the dehumidification start humidity 2. The temperature is lower than the dehumidification start temperature Stop dehumidification when any of the following conditions are met: 1. The humidity is lower than the dehumidification stop humidity 2. The temperature is higher than the dehumidification stop temperature

• LZXD-3.5GE

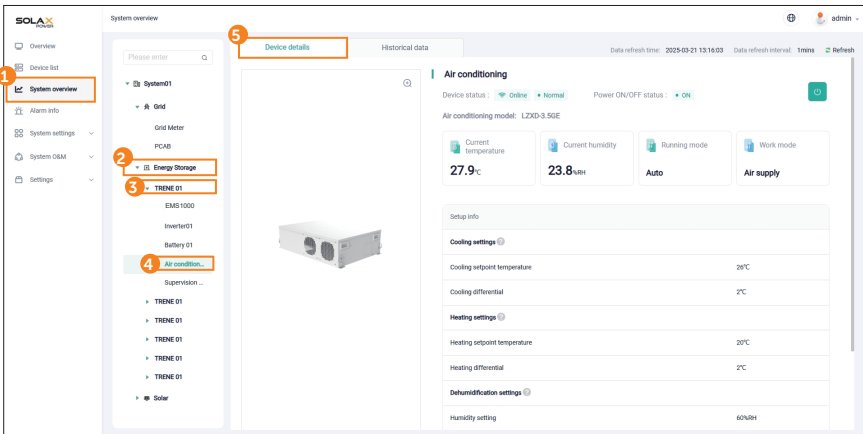

Figure 6-64 Information on LZXD-3.5GE air conditioner

Table 6-23 Parameter description on LZXD-3.5GE air conditioner

Data Type	Parameter	Description
Device info	Device status	Includes the online/offline status and operation status of the air conditioner
	Power ON/OFF status	ON/OFF status of the air conditioner
	Air conditioning model	Model of the air conditioner
Real-time info	Current temperature	Real-time ambient temperature inside the cabinet
	Current humidity	Real-time humidity inside the cabinet
	Run	Operation mode of the air conditioner, including automatic, forced cooling, forced heating, forced air supply and forced standby
	Work mode	Real-time running status of the air conditioner, including cooling, heating, air supply and standby
Setup info (Available only when the Run mode is Automatic)	Cooling settings	Includes the cooling point temperature and cooling return difference. The air conditioner will start cooling when the temperature is higher than the cooling setpoint temperature + cooling differential, and stop when lower than the cooling setpoint temperature-cooling differential.
	Heating settings	Includes the heating point temperature and heating return difference. The air conditioner will start heating when the temperature is lower than the heating setpoint temperature-heating differential, and stop when higher than the heating setpoint temperature + heating differential.

Data Type	Parameter	Description
Setup info (Available only when the Run mode is Automatic)	Dehumidification settings	Includes humidity setting, humidity differential, humidity dead zone and dehumidification temperature. Dehumidification is triggered when the following two conditions are met at the same time: 1. The temperature is 2°C higher than the dehumidification temperature 2. The humidity is higher than the humidity setting + humidity differential Stop dehumidification when any of the following conditions are met: 1. The temperature is lower than the dehumidification temperature 2. Humidity is lower than the humidity setting+humidity dead zone

Turning on or off air conditioner

Step 1: Log in to the webpage, and then select **System overview > Energy Storage Photovoltaic/Energy Storage > Cabinet > Air Conditioner > Device details**.

Step 2: Click  to turn on or off the air conditioner, and then click **Confirm** on the confirmation pop-up.

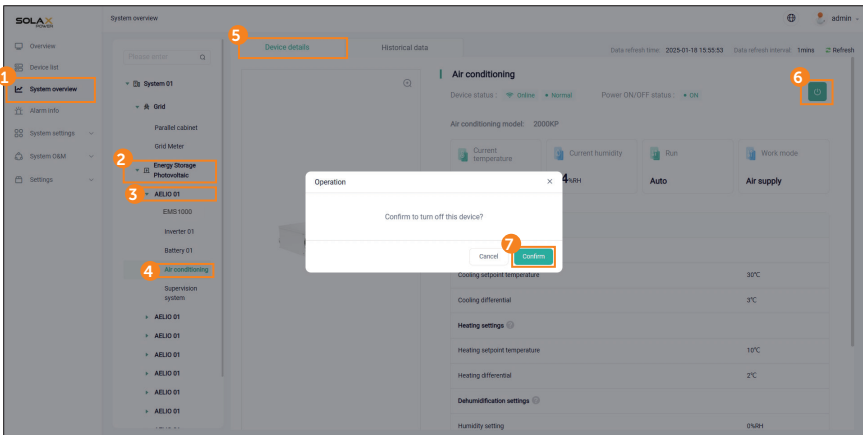

Figure 6-65 Turing on or off the air conditioner

Viewing historical data

View information on air conditioner historical operation.

Step 1: Log in to the webpage, and then select **System overview > Energy Storage Photovoltaic/Energy Storage > Cabinet > Air conditioning > Historical data**.

Step 2: Set the **Time** and click **Check**.

The maximum time interval is 7 days, and you can set the number of the record to be displayed per page to 10, 20, 30, 40 and 50, or directly enter the page number to go to a defined page.

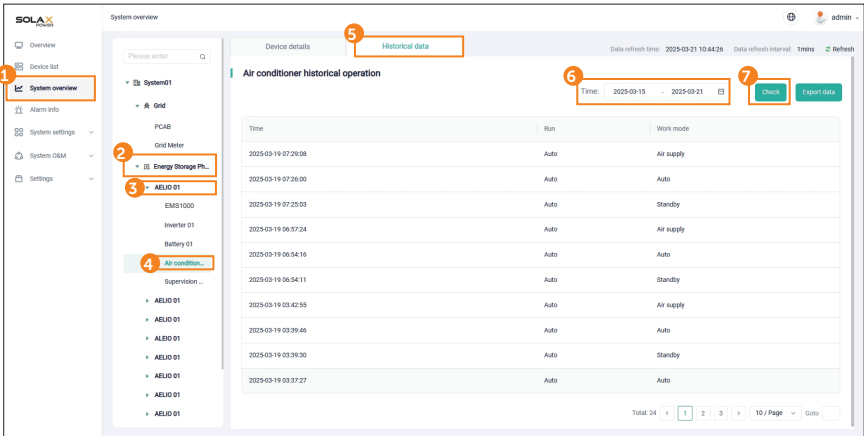

Figure 6-66 Searching for the air conditioner historical data

Step 3: Click **Export data** to export the air conditioner historical operation record as a table.

6.6.8 Supervision System

You can check the status of the multiple monitoring devices in the cabinet, such as the water sensor, SPD, temperature sensor and more, and turn on or turn off the cabinet control devices. The supervision system ensures the entire energy system operates in a safe and normal environment.

Viewing supervision system information

Log in to the webpage, and then select **System overview > Energy Storage Photovoltaic/Energy Storage > Cabinet > Supervision system > Device details**.

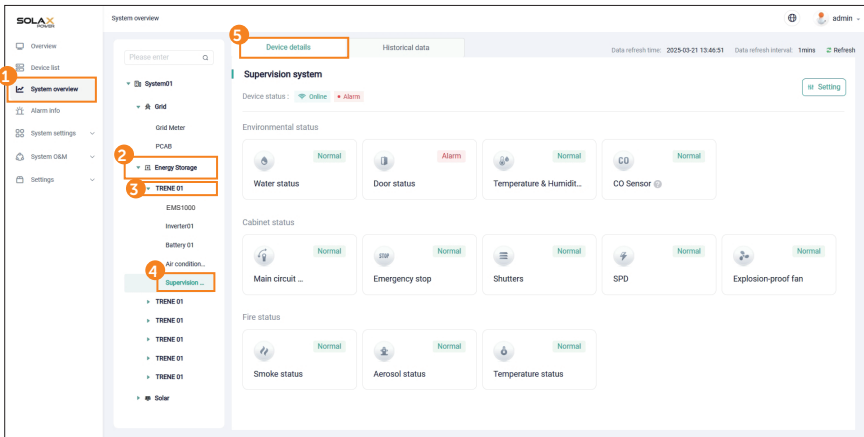

Figure 6-67 Viewing supervision system information

Parameter	Description
Device status	Includes the communication status of the supervision system with EMS1000, and the operation status of the entire system. Whatever component in the cabinet is abnormal, the system status displays Alarm .
Environmental status	Whether the environmental status of the cabinet is normal, including water, door, temperature and humidity, and CO. <ul style="list-style-type: none"> • Normal: No exception is detected • Alarm: An exception occurs
Cabinet status	Includes the status of the main circuit breaker, emergency stop, shutters, SPD and explosion-proof fan. When the emergency stop is turned on, its status displays as Alarm ; if it remains turned off, the status displays as Normal . <ul style="list-style-type: none"> • Normal: The component is normal • Alarm: The component is abnormal
Fire status	Includes the status of the smoke sensor, aerosol sensor and temperature sensor. <ul style="list-style-type: none"> • Normal: The density of smoke and aerosol, and the temperature inside the cabinet remain in a normal range. • Alarm: The density of smoke and aerosol, and temperature inside the cabinet are abnormal.

Setting access control protection

Enable the function and set the duration that the cabinet door can be kept open to protect the system against potential risks. When the function is enabled, once the door is opened, the system will initiate a countdown warning, and then automatically shut down when the opening duration threshold is met.

Step 1: Log in to the webpage, and then select **System overview > Energy Storage Photovoltaic/Energy Storage > Cabinet > Supervision system > Device details > Setting**.

Step 2: On the setting pop-up, select **Yes**, set the **Time** duration, and then click **Confirm**.

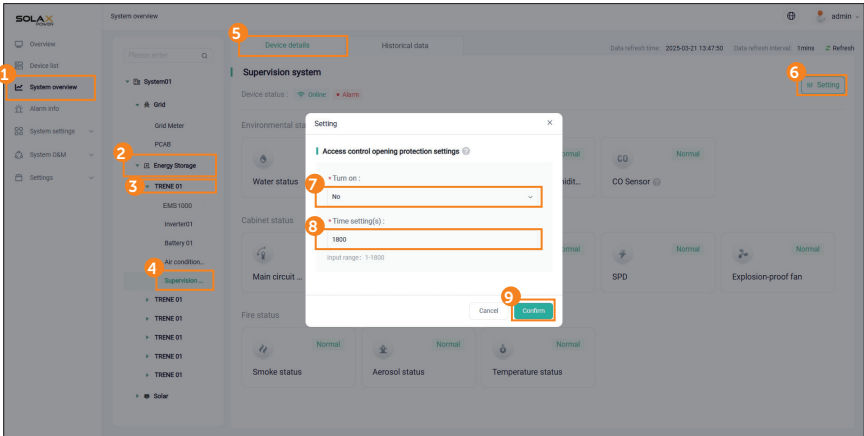

Figure 6-68 Setting access control protection

Viewing historical data

View information on cabinet environment analysis.

Step 1: Log in to the webpage, and then select **System overview > Energy Storage Photovoltaic/Energy Storage > Cabinet > Air conditioning > Historical data**.

Step 2: Set the **Time** and click **Check**.

The maximum time interval is 7 day.

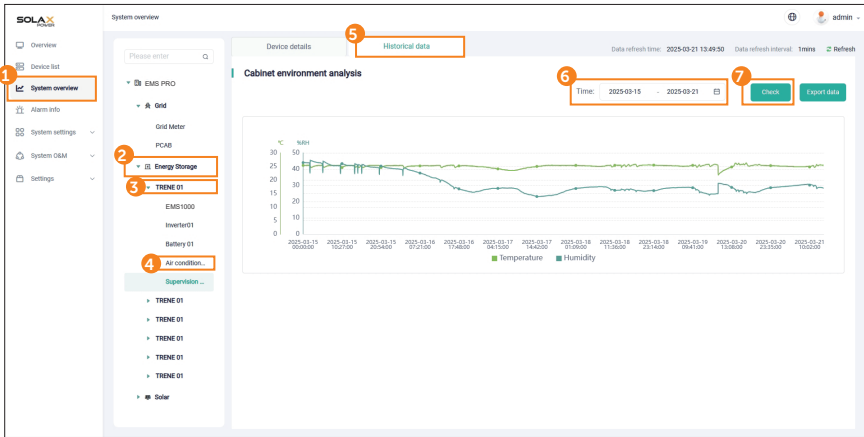

Figure 6-69 Checking the cabinet environment analysis

Step 3: Click **Export data** to export the cabinet environment analysis record.

6.6.9 Grid-connected inverter

You can view the real-time data and historical data of the grid-connected inverter. Operations are similar to those on the inverter in the cabinet. For details, see "6.6.5 Inverter".

NOTICE!

The system currently supports the following grid-connected inverter models: X3-PRO G2, X3-MEGA G2 and X3-FORTH.

6.7 Alarm Information

Alarms from all devices that EMS1000 PRO manages are displayed here in a reverse order by the time that the alarm occurred. 10 alarms are displayed per page by default, and you can set this number to 20, 30, 40 and 50, or directly enter the page number to go to a specific page.

6.7.1 Viewing Alarms

Alarm information includes the device type and SN, alarm name, error code, alarm level, time that the alarm occurs and ends, alarm status and more.

Step 1: Log in to the webpage, and then select **Alarm info**

Step 2: Select **Current / History**.

The **Current** displays current alarms, and **History** displays resolved alarms

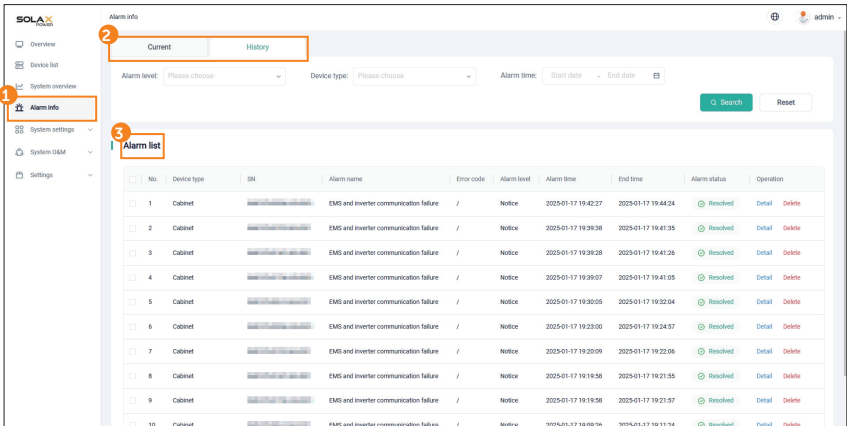

Figure 6-70 Viewing alarm information

Table 6-24 Alarm information description

Parameter	Description
Device type	The device with which the alarm occurs
SN	SN of the alarm device
Alarm name	Brief description of the alarm
Error code	Only available for inverter errors
Alarm level	Emergency urgency level of the alarm, divided into critical, warning and notice
Alarm time	Time that the alarm occurs

Parameter	Description
End time	Time that the alarm is resolved
Alarm status	<ul style="list-style-type: none"> • Pending: Alarms that are not resolved yet • Resolved: Alarms that have been resolved

You can click **Detail** under **Operation** on each alarm to view more details on the alarm, and the possible causes and suggestions that we offer for each type of alarm. This helps you to solve the problem quickly and efficiently.

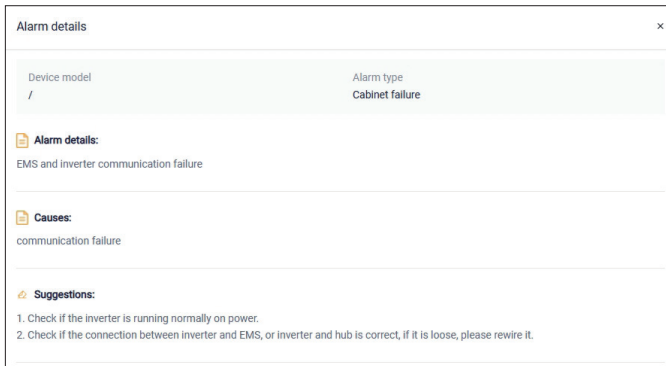

Figure 6-71 Alarm details

6.7.2 Deleting Alarms

Resolved alarms can be deleted one by one or in batches.

- Deleting alarms one by one

Step 1: Log in to the webpage, and then click **Alarm info**.

Step 2: Under **Alarm list**, click **Delete** on the alarm that you want to delete, and then click **Delete** on the confirmation pop-up.

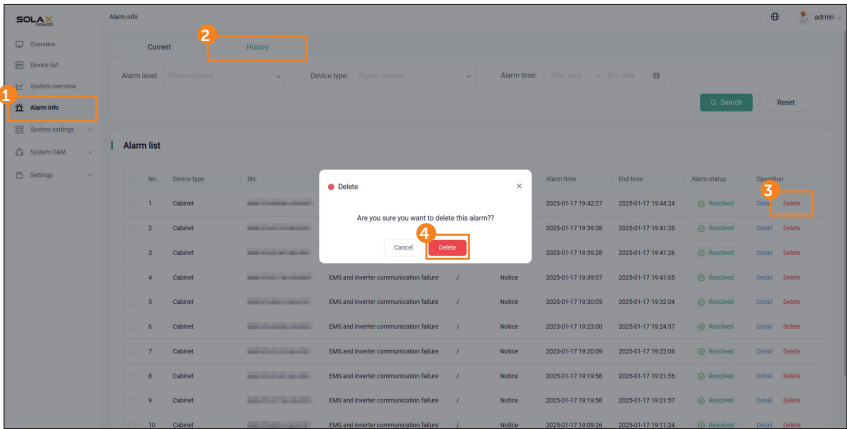

Figure 6-72 Deleting an alarm

- Deleting alarms in batches

Step 1: Log in to the webpage, and then click **Alarm info**.

Step 2: Select the checkbox in the front of the resolved alarms that you want to delete, click **Batch delete**, and then click **Delete** on the confirmation pop-up.

You can also select the checkbox on the head of the alarm list to select all resolved alarms, and then delete all these resolved alarms in batches.

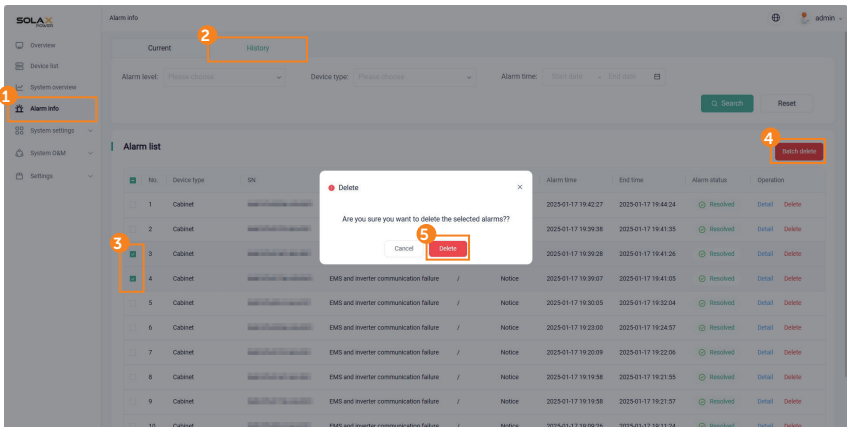

Figure 6-73 Deleting alarms in batches

6.7.3 Searching for Alarms

You can search for alarms by alarm level, alarm status, device type and alarm time. The search results will be displayed in the list below.

Log in to the webpage, click **Alarm info**, select **Current / History**, set the search conditions, and then click **Search**.

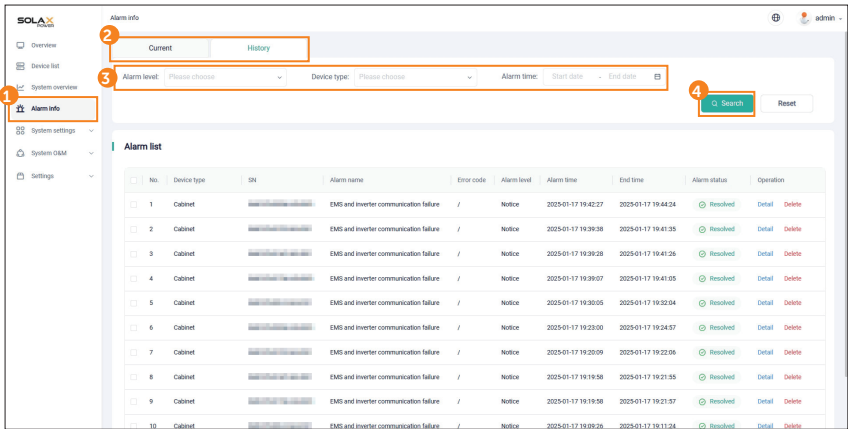

Figure 6-74 Searching for alarms

Related operation

Click **Reset** to clear the search conditions.

6.8 System Settings

Set the work mode, import control, export control and ripple control for the system.

6.8.1 Work Mode

For AELIO system, 4 work modes are supported, namely self-use, manual mode, peak shaving and TOU. For TRENE system, self-use, manual mode, and TOU are available.

You can adjust the work mode of the system based on local situations to make full use of the PV energy and maximize the revenue.

Self use mode

Select self-use mode where the feed-in subsidies are low and electricity price is high. You need to set a minimal battery SOC.

- Step 1:** Log in to the webpage, and then select **System management > System settings > Work mode**.
- Step 2:** Under **System work mode**, select **self use** from the drop-down list, and then click **Execute**.
- Step 3:** Set the **Min SOC**, and then click **Save** for the parameter to take effect.

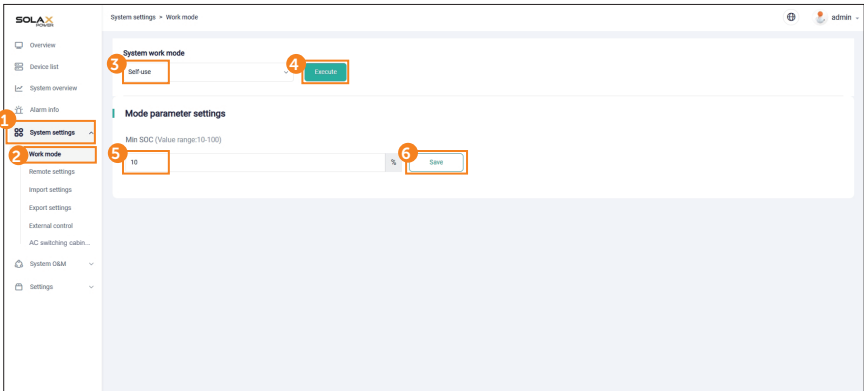

Figure 6-75 Setting self-use mode

Table 6-25 Self Use mode parameter description

Parameter	Description
Min SOC	Minimum SOC for the battery to discharge. If the system SOC is less than or equal to the minimum SOC, the system enters the standby state

Manual mode

Under manual mode, you can force the system to charge the battery, force the battery to discharge or stop charging and discharging.

Step 1: Log in to the webpage, and then select **System management > System settings > Work mode**.

Step 2: Under **System work mode**, select **Manual mode** from the drop-down list, and then click **Execute**.

Step 3: Select the operation from the drop-down list for the system, and then click **Save**.

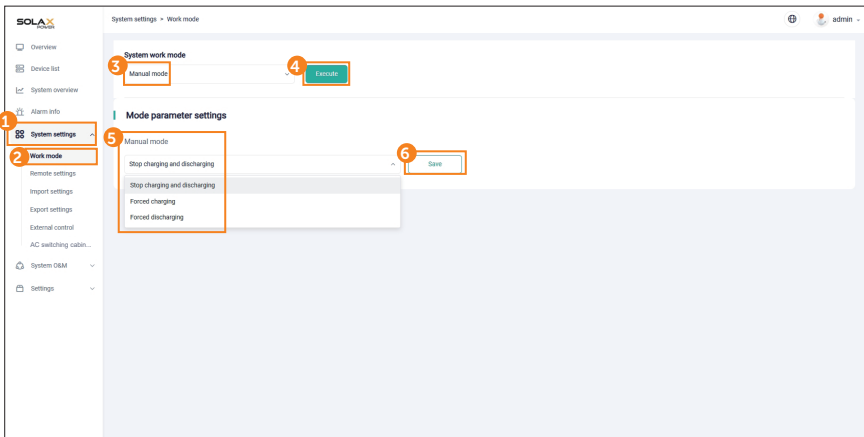

Figure 6-76 Setting Manual mode

Peak shaving mode

Select peak shaving mode when you need to level out peaks in electricity use. You need to set the periods and threshold for discharging, and select whether to allow charge from grid, and other parameters.

Step 1: Log in to the webpage, and then select **System management > System settings > Work mode**.

Step 2: Under **System work mode**, select **Peak Shaving** from the drop-down list, and then click **Execute**.

Step 3: Set the parameters, and then click **Save** for the parameter to take effect.

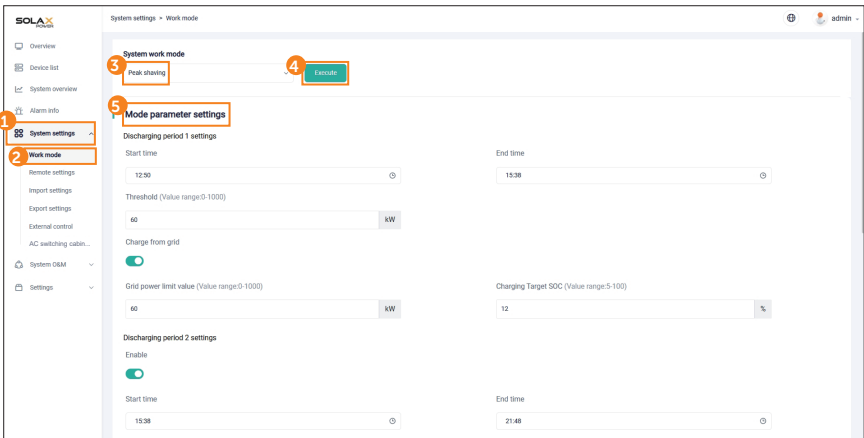

Figure 6-77 Setting peak shaving mode

Table 6-26 Peak shaving mode parameter description

Parameter	Description
Start time	Time that the battery starts discharging
End time	Time that the battery stops discharging
Threshold	Max amount of power that the battery can discharge
Charge from grid	Whether to allow charging the battery from grid
Grid power limit value	Power limit for charging from the grid or feed into the grid
Charging target SOC	Target State of Charge (SOC) of the battery, stops charging when reached

TOU

Configure strategies and templates for the system to automatically perform operations based on preset schedules.

- Step 1:** Log in to the webpage, and then select **System management > System settings > Work mode**.
- Step 2:** Under **System work mode**, select **Manual mode** from the drop-down list, and then click **Execute**.
- Step 3:** Set **Strategy configuration** and **Template configuration**.

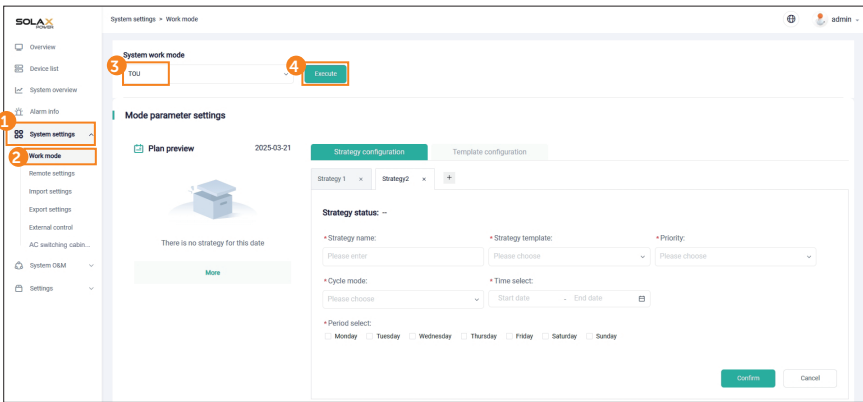

Figure 6-78 Setting TOU mode

- **Setting Strategy Configuration**

Step 1: Under **Mode parameter settings**, click **Strategy configuration**.

Step 2: Configure parameters for the strategy, and then click **Confirm**.

There is a default strategy format for you to enter specific information, and you can click **+** to configure more strategies. Up to 20 strategies can be added.

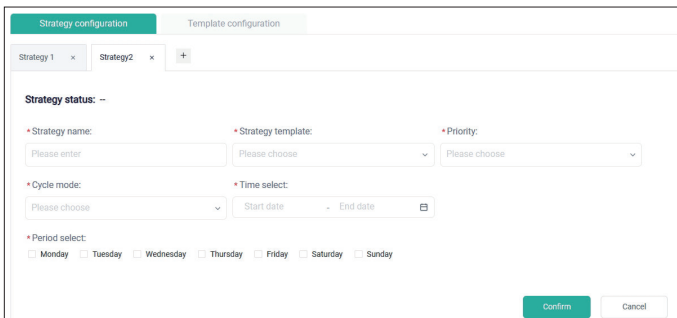

Figure 6-79 Configuring strategy

Table 6-27 Strategy parameters

Parameter	Value Range	Description
	--	Default value when a new strategy is being created
Strategy State	Not Applied	The strategy is created but not applied.
	Applied	The strategy has been applied.
Strategy name	/	Set a name for the strategy
Strategy template	/	Select a template that you created in the previous step for the strategy.
Priority	1-20	Priority of the current strategy when the execution time of multiple strategies overlaps. 1 stands for top priority, and 20 the least priority.
Cycle Mode	Repeat Weekly	Repeat the strategy by week
	Repeat Daily	Repeat the strategy by day
Time Select	/	Start date and end date that the strategy takes effect after being applied.
Period Select		This parameter is required only when Cycle Mode is set to Repeat Weekly . You can select the specific data in a week that the strategy will take effect.

Related operation

Click **Editing** to modify the strategy that has been created. Click **Confirm**, the strategy will be applied to the plan, and the **Strategy status** changes from **Not Applied** to **Applied**. You can click **Stop** to cancel the application.

- **Setting Template Configuration**

A template defines the specific working mode that the system should follow within a specific period, and the related parameters in the working modes.

Step 1: Under **Mode parameter settings**, click **Template configuration**.

Step 2: Configure parameters for the template, and then click **Confirm**.

There is a default template format for you to enter specific information, and you can click **+** to configure more templates.

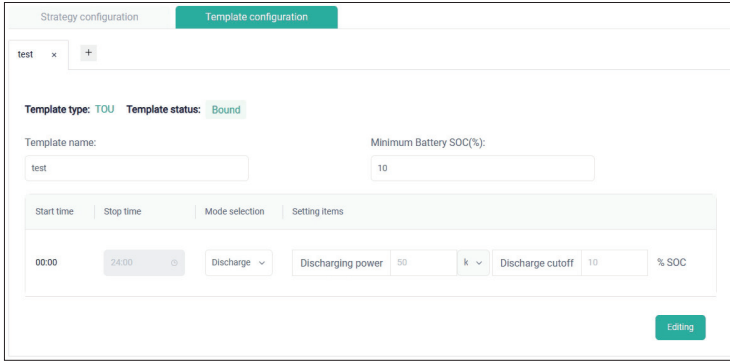

Figure 6-80 Configuring templates

Table 6-28 Template parameter description

Parameter	Value Range	Description
Template type	TOU	Currently, only TOU template is available.
Template status	--	Default value when a template is being created
	Unbound	The template is created but not bound to any strategy.
Template Name	Bound Up	The template is bound to one or more strategies.
	/	Set a name for the template.
Minimum battery SOC	10~100	Lowest battery SOC for the template to take effect.
Start time	/	Time duration that the battery cluster charges, discharges or remains standby. The time interval is 30 minutes.
End time	/	
Mode selection	Self-use	See " Self Use Mode "
	Battery off	Keep the battery standby
	Peak shaving	See " Peak Shaving Mode "
Mode selection	Charge	Charge the battery
	Discharge	The battery discharges to supply power for the system

Viewing plans

The strategy that takes effect on the day will be displayed on **Plan preview**, including the strategy and template that are carried out and the specific operation to be performed in each period. You can click **More** to view the plans on a monthly basis, and check the details of settings for the periods.

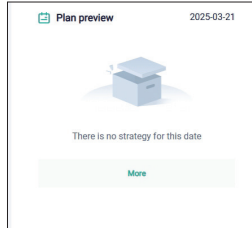

Figure 6-81 Viewing plans

6.8.2 Remote Settings

Set parameters for the inverter remotely on EMS1000 PRO webpage.

NOTICE!

This function is currently only available for X3-AELIO, X3-TRENE-100K, X3-TRENE-100KI, X3-TRENE-125K, X3-MEGA G2 and X3-FORTH inverters.

- Step 1:** Log in to the webpage, and then select **System settings > Remote setting**.
- Step 2:** Select the inverter SN, and then click **Confirm**.
- Step 3:** Enter the password, click **Confirm**, and then continue the configurations.

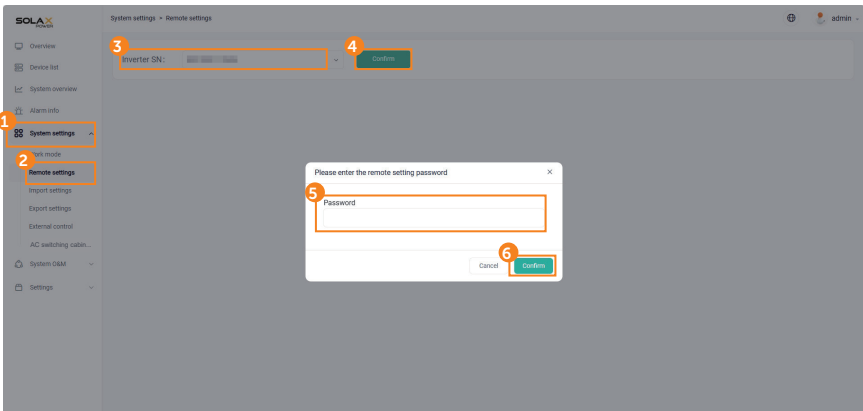

Figure 6-82 Configuring parameter setting

6.8.3 Import Settings

Set a maximum power value that the system can import from the grid to keep the expenses on power in control. When the total power that the system consumed from the grid reaches the value, the system cut off power supply from the grid.

Step 1: Log in to the webpage, and then select **System settings > Import settings**.

Step 2: Enable the function, set the **Control mode** and **Total demand**, and click **Save**.

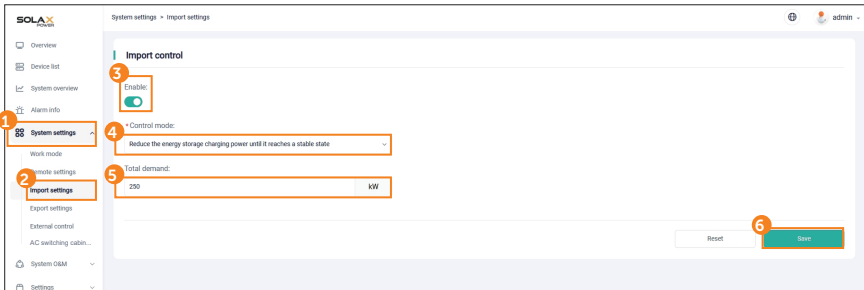

Figure 6-83 Setting import control

Related operation

Click **Reset** to clear the settings.

6.8.4 Export Settings

Set a maximum power value that the system can export to the grid. When the total power or power per phase that the system delivers to the grid reaches the limit value, the system stops exporting power to the grid. This is ideal for use in countries and regions with grid-connection export control.

Step 1: Log in to the webpage, and then select **System settings > Export settings**.

Step 2: Enable the function, select the **control mode**, set the **Export limit** value, and then click **Save**.

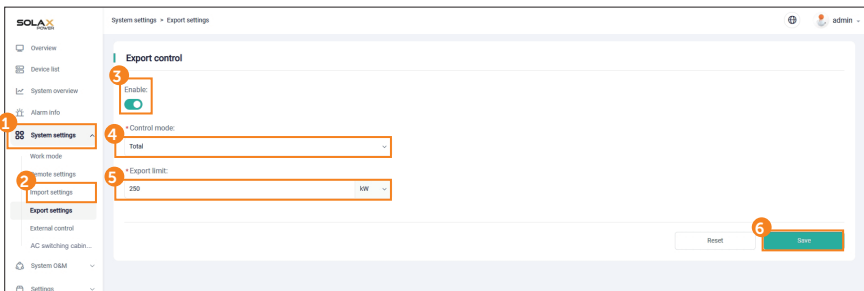

Figure 6-84 Setting export control

Table 6-29 Export control parameter description

Parameter	Value range	Description
Control mode	Total	The sum of power exported to the grid from all phases cannot exceed the limit
	Per phase	The power exported to the grid from each phase cannot exceed the limit
Export limit	%	Control the export power value by the percentage of the inverter power rate
	kW	Control the export power value by specific power amount

Related operation

Click **Reset** to clear the settings.

6.8.5 External Control

EMS1000 PRO offers 4 DI channels and 16 combination options for ripple control. You can enable the combinations and set control items for the system, such as shut down the inverter, set input and output power limit and more. Ripple control takes effect for the entire system, and has priority over other system settings.

Step 1: Log in to the webpage, and then select **System settings > External control**.

Step 2: Click  and then click **Ok** on the confirmation pop-up.

Step 3: Enable the DI combination option, select the control item, and then set the related parameters.

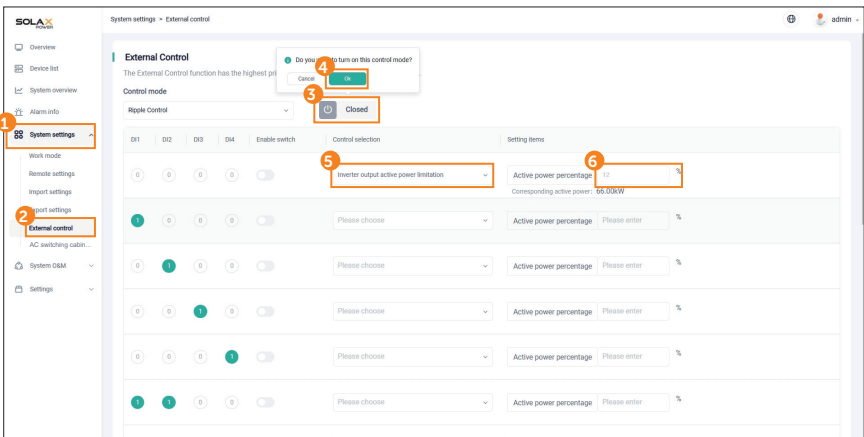

Figure 6-85 Setting ripple control

Table 6-31 Alarm information description

Parameter	Description
Inverter output active power limitation	Ratio of the inverter active power that can feed in to the grid
Inverter input active power limitation	Ratio of the inverter active power that can be imported from the grid
Inverter output reactive power limitation	Set the power factor, and the reactive mode, either leading or lagging.
Inverter grid-tied power limitation	Ratio of grid-tied power output; used for zero output
Inverter shutdown	Shut down the inverter

6.8.6 AC Switching Cabinet Settings

If the EMS1000 PRO is connected to the AC switching cabinet, you can set it on this page:

- Step 1:** Log in to the webpage, and then select **System settings > AC switching cabinet settings**.
- Step 2:** Set the off-grid voltage and off-grid frequency, and then click **Save**.
- Step 3:** Set the **Switching method**, and then click **Save**.
- Step 4:** If **Manual recovery** is selected, you can manually switch the on-grid/off-grid operation status of the system.
- Step 5:** Enable the **Diesel generator control enable**, set the related parameters, and then click **Save**.

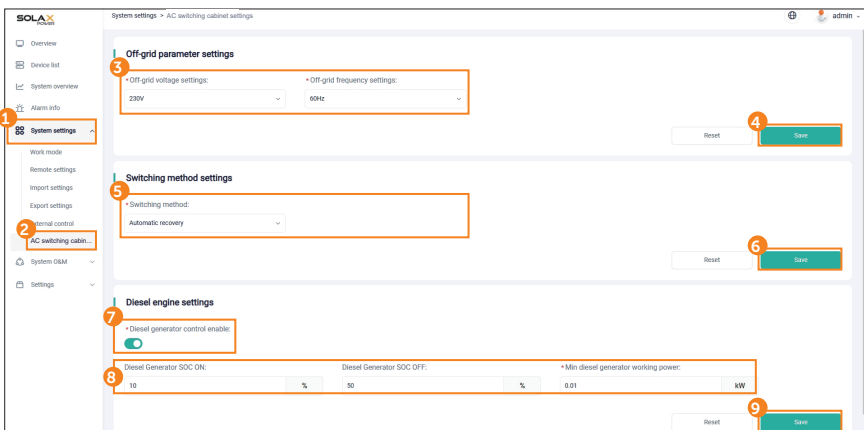

Figure 6-86 Setting AC switching cabinet settings

Table 6-32 AC switching cabinet settings information description

Value range	Description
Automatic recovery	The system automatically performs on-grid/off-grid switching according to the mains status.
Manual recovery	The system supports users to manually switch the on-grid/off-grid status of the system.
Diesel Generator SOC ON	When the set SOC value is reached, turn ON the diesel generator
Diesel Generator SOC OFF	When the set SOC value is reached, turn OFF the diesel generator
Min diesel generator working power	Minimum operating power of diesel generator, long-term operation below the minimum power may result in increased fuel consumption but reduced efficiency of the diesel generator

6.9 System O&M

On this page, you can upgrade the devices in the system.

NOTICE!

The devices upgrade function is only available for the admin account.

Step 1: Log in to the webpage, and then select **System O&M > Device upgrade**.

Step 2: Set the **Device type** and **Device model**, and then click **Search**.

You can set the number of the record to be displayed per page to 10, 20, 30, 40 and 50, or directly enter the page number to go to a defined page.

Step 3: Select the checkbox in the front of the devices that you want to upgrade, click **One-click upgrade**.

Step 4: On the **Firmware upgrade** pop-up, click **Choose file**, import the update firmware file, and then click **Upgrade**.

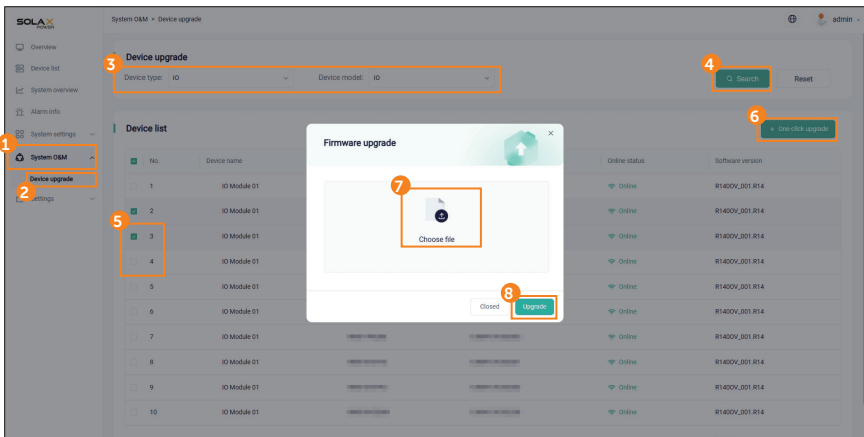

Figure 6-87 Upgrading the devices

Related operation

Click **Reset** to clear all existing parameters.

6.10 Settings

Set parameters for the eight RS485 channels of EMS1000 PRO, perform related operations on EMS1000 PRO such as maintenance, system upgrade and data clearance, and configure network settings for it.

6.10.1 RS485 Settings

Configure parameters for the eight RS485 channels that EMS1000 PRO offers to suit the connection requirements of multiple devices.

Step 1: Log in to the webpage, and then select **Settings > RS-485 settings**.

Step 2: For each channel, set the **Baud rate**, **Parity** and **Stop bit** as needed, and then click **Save**.

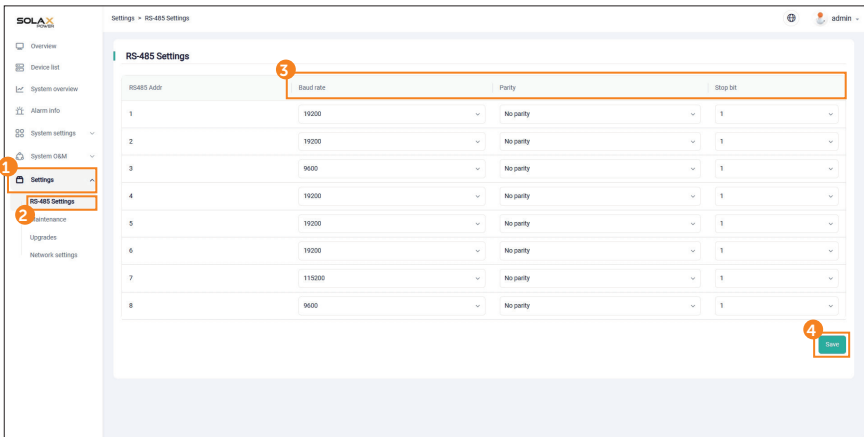

Figure 6-88 Configuring RS485 settings

Table 6-33 RS485 setting parameter description

Parameter	Description
Baud rate	Data transmission rate of the channel, includes 9600, 19200, 38400, 57600 and 115200
Parity	Currently, only No Parity is supported.
Stop Bit	1 stop bit and 2 stop bits are supported.

6.10.2 EMS Maintenance

Restart EMS1000 PRO, clear cache and data, restore it to factory settings if you need to, and enable or disable remote setting for remote access to the webpage through SolaXCloud platform.

6.10.2.1 Resetting System

This is to simply restart EMS1000 PRO, and the system data will not be impacted.

Step 1: Log in to the webpage, and then select **Settings > Maintenance**.

Step 2: On **System reset**, click **Execute**, and then click **Confirm** on the confirmation pop-up.

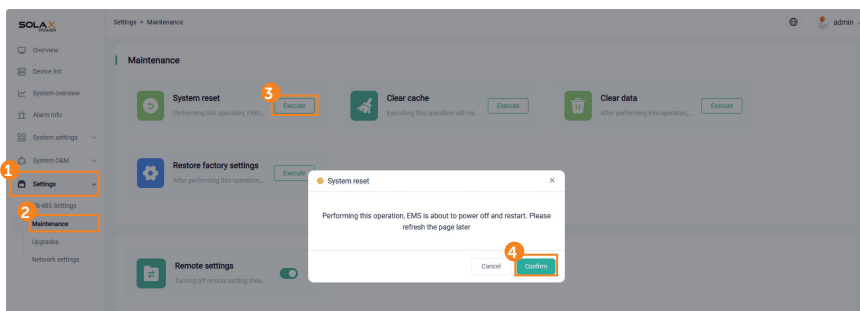

Figure 6-89 Resetting the system

6.10.2.2 Clearing Cache

This is to clear the data stored during network breakpoint.

Step 1: Log in to the webpage, and then select **Settings > Maintenance**.

Step 2: On **Clear cache**, click **Execute**, and then click **Confirm** on the confirmation pop-up.

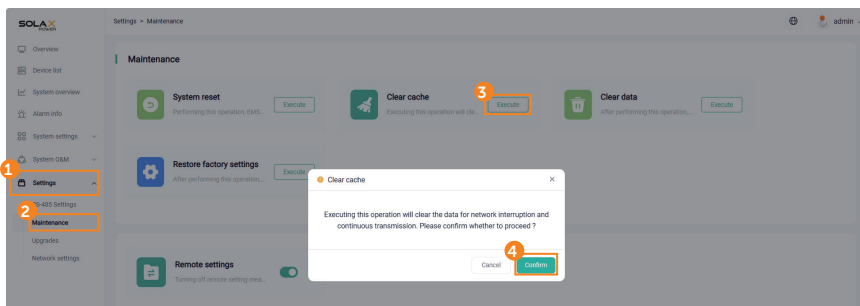

Figure 6-90 Clearing system cache

6.10.2.3 Clearing Data

This is to clear all historical data stored in EMS1000 PRO SSD.

Step 1: Log in to the webpage, and then select **Settings > Maintenance**.

Step 2: On **Clear data**, click **Execute**, and then click **Confirm** on the confirmation pop-up.

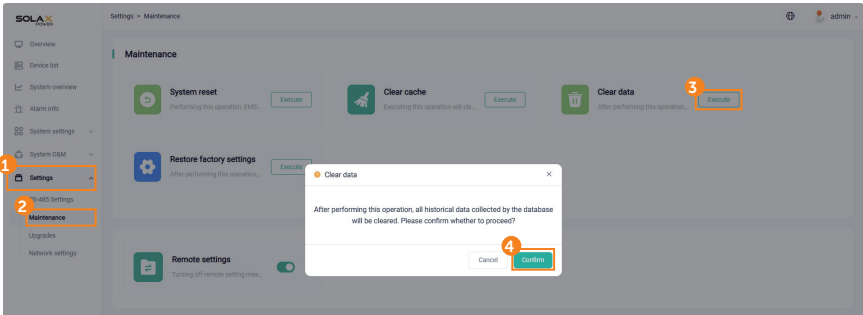

Figure 6-91 Clearing system data

6.10.2.4 Restoring Factory Settings

NOTICE!

EMS1000 PRO will restore to factory settings and restart after you perform this function, and you need to unplug and plug the network cable again before you can continue to use the Device normally.

Step 1: Log in to the webpage, and then select **Settings > Maintenance**.

Step 2: On **Restore factory settings**, click **Execute**, and then click **Confirm** on the confirmation pop-up.

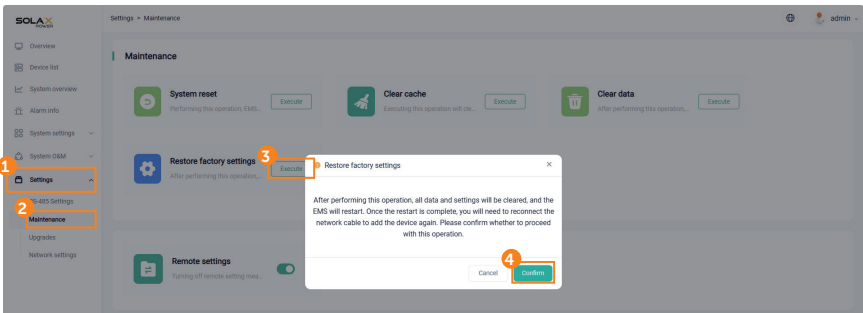

Figure 6-92 Restoring EMS1000 PRO to factory settings

6.10.2.5 Remote Setting

Turn on or off remote setting on the webpage to allow or prevent SolaXCloud platform accessing the webpage remotely. The function is enabled by default.

Step 1: Log in to the webpage, and then select **Settings > Maintenance**.

Step 2: On **Remote setting**, click the enable and disable toggle, and then click **Confirm** on the confirmation pop-up.

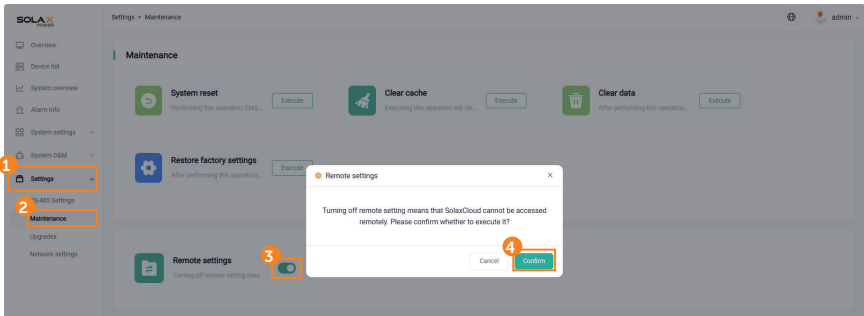

Figure 6-93 Disabling remote setting

6.10.3 EMS System Upgrade

NOTICE!

- System upgrade is available only for Admin account.
- Operations on EMS1000 PRO are not available during upgrade.

Step 1: Log in to the webpage, and then select **Settings > Maintenance**.

Step 2: Click **Choose file** on the page, select and import the upgrade file, and then click **Upgrade** to start upgrading.

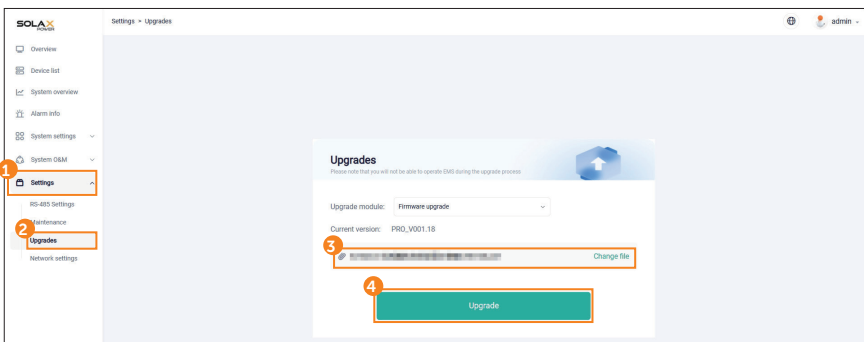

Figure 6-94 Upgrading EMS1000 PRO

6.10.4 Network Settings

Configure network parameters for EMS1000 PRO under 4G and LAN mode.

Step 1: Log in to the webpage, and then select **Settings > Maintenance**.

Step 2: Set **Communication method** to **LAN** or **4G**, set the corresponding parameters, and then click **Save**.

NOTICE!

The external network segment cannot be 192.168.10.X, 192.168.11.X, 192.168.12.X, 192.168.13.X or 192.168.14.X in case of IP address conflict.

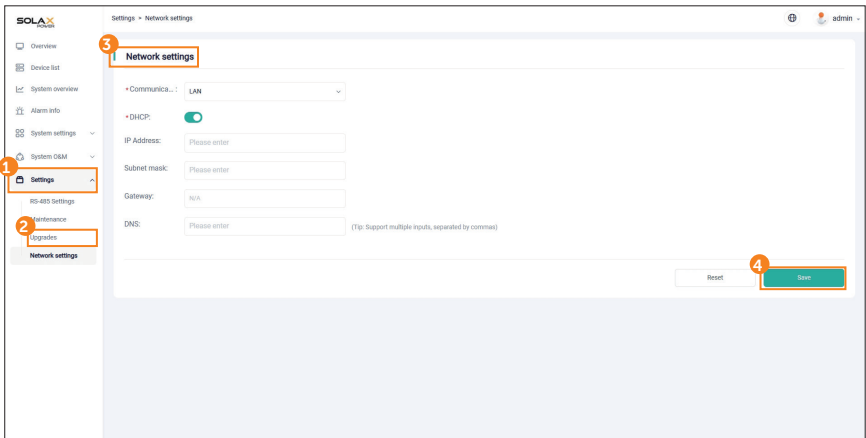

Figure 6-95 Setting network parameters

Related operation

Click **Reset** to clear all existing parameters.

7 Maintenance and Troubleshooting

7.1 Maintenance

Maintain EMS1000 PRO regularly to ensure its long-term stable performance.

Table 7-1 Maintenance routine

No.	Maintenance Item	Cycle
1	Check and update the software of EMS1000 PRO when new software versions are released.	Subject to the official release of a new version
2	Modify the password regularly, and keep the password at a relatively high security level.	Subject to the maintenance of the system
3	Check the hardware status of EMS1000 PRO, including the terminals, the LED indicators and more.	
4	Check the connection and arrangement of the cables.	

7.2 Troubleshooting

When an exception occurs, check the troubleshooting list below for possible reasons and solutions. For problems that cannot be solved or not specified in the list, contact our technical support. By then, prepare your device SN and problem.

Table 7-2 Possible problems, reasons and solutions

No.	Problem	Possible Reason	Solution
1	EMS1000 PRO cannot be powered on.	<ul style="list-style-type: none">• The power cable connection is incorrect. For example, the + and – poles are reversely connected.• The power supply terminal is not inserted into, or is loose from the main part of EMS1000 PRO.• The cabinet where EMS1000 PRO is installed in has no power supply.• EMS1000 PRO exception	<ul style="list-style-type: none">• Check the wiring of the power supply terminal, and secure the screw for it.• Supply power for the cabinet.• Contact the installer or SolaX technical support.

No.	Problem	Possible Reason	Solution
2	Connected devices cannot be found.	<ul style="list-style-type: none"> • The wiring sequence of the communication cables is incorrect. • The communication cables are not properly connected to the correct terminals of EMS1000 PRO. • The parameters set for RS485 communication on the webpage are inconsistent with the actual situation. 	<ul style="list-style-type: none"> • Check the connection status of the communication cables, and reconnect them if necessary. • Check the parameters for RS485 communication, and ensure that the baud rate, parity and stop bit are set correctly. If multiple devices are connected through RS485 terminals, the address cannot be repeated.
3	The device connected to EMS1000 PRO displays offline on the webpgae.	<ul style="list-style-type: none"> • The communication cable between EMS1000 PRO and the device is not properly connected. • The device is powered off or is abnormal. • The device communication parameters have been modified. • The device has been replaced. 	<ul style="list-style-type: none"> • Check the communication cable connection, and reconnect it if necessary. • Check if the device is powered off or fails to operate due to exception. In this case, troubleshoot the device and power on it again. • Check the RS485 communication parameters of the device, and set these parameters to be compatible with EMS1000 PRO. • If the device has been replaced, search for it or manually add it to EMS1000 PRO again.
4	Communication between EMS1000 PRO and SolaXCloud platform fails.	<ul style="list-style-type: none"> • EMS1000 PRO fails to bind a plant on SolaXCloud platform. • 4G communication fails. • LAN communication fails. 	<ul style="list-style-type: none"> • Create a new plant and bind EMS1000 PRO to it, or directly bind EMS1000 PRO to an existing plant. • See solutions for 4G communication failure below. • See solutions for LAN communication failure below.

No.	Problem	Possible Reason	Solution
6	4G communication fails.	<ul style="list-style-type: none"> • SIM card is not inserted, is damaged or runs out of credit. • 4G communication parameters are set incorrectly. • 4G signal strength is weak. 	<ul style="list-style-type: none"> • Check the SIM card slot, and make sure the SIM card is in good condition and properly inserted. • Contact the mobile service provider or solax technical support to recharge. • Check the 4G communication parameters, and make sure the APN information are correct. • Fasten or replace the antenna. • Check the 4G signal on EMS1000 PRO webpage.
7	LAN communication fails.	<ul style="list-style-type: none"> • The network cable of EMS1000 PRO is connected to the wrong NET terminal. • Abnormal network on the site • The communication is blocked by the network firewall • LAN communication parameters are set incorrectly. 	<ul style="list-style-type: none"> • Check and make sure that the network cable is connected to NET4 of EMS1000 PRO. • Check the availability of local network through a computer or phone. • Check the firewall settings of local network, and release the domain and port that EMS1000 PRO communicates with SolaXCloud platform. • Select the IP acquisition method supported by the local network. For static IP, correctly enter the IP address, subnet mask, DNS and gateway.
8	Device pairing failed.	The wiring between the cabinet and its devices is abnormal.	Check the wiring, reconnect the cables, and try again.

8 Technical Data

Model	EMS1000 PRO
Power supply	12 V.d.c-24 V.d.c
Ethernet	10/100/1000 Mbps
Dimensions (L x W x H)	232.0 mm x 113.5 mm x 59.0 mm
Weight	1900g
Max. power consumption	27 W
Operating temperature range	-40°C to +60°C
Ingress protection	IP20

Contact Information



UNITED KINGDOM



Unit C-D Riversdale House, Riversdale
Road, Atherstone, CV9 1FA



+44 (0) 2476 586 998



service.uk@solaxpower.com



TURKEY



Fevzi Çakmak mah. aslım cd. no 88 A
Karatay / Konya / Türkiye



service.tr@solaxpower.com



USA



3780 Kilroy Airport Way, Suite 200, Long
Beach, CA, US 90806



+1 (408) 690 9464



info@solaxpower.com



POLAND



WARSAW AL. JANA P. II 27. POST



+48 662 430 292



service.pl@solaxpower.com



ITALY



+39 011 19800998



support@solaxpower.it



PAKISTAN



service.pk@solaxpower.com



AUSTRALIA



21 Nicholas Dr, Dandenong South VIC 3175



+61 1300 476 529



service@solaxpower.com.au



GERMANY



Am Tullnaupark 8, 90402 Nürnberg,
Germany



+49 (0) 6142 4091 664



service.eu@solaxpower.com



service.dach@solaxpower.com



NETHERLANDS



Twekkeler-Es 15 7547 ST Enschede



+31 (0) 8527 37932



service.eu@solaxpower.com



service.bnl@solaxpower.com



SPAIN



+34 9373 79607



tecnico@solaxpower.com



BRAZIL



+55 (34) 9667 0319



info@solaxpower.com



SOUTH AFRICA



service.za@solaxpower.com



SolaX Power Network Technology (Zhejiang) Co., Ltd.

Add.: No. 278, Shizhu Road, Chengnan Sub-district, Tonglu County,
Hangzhou, Zhejiang, China
E-mail: info@solaxpower.com

