



UL INTERNATIONAL (UK) LTD
 Womersley House, Building C,
 The Guildway,
 Old Portsmouth Road,
 Guildford. GU3 1LR.
 United Kingdom.



designated according to Article 29 of the Regulation (EU) No 305/2011 and member of EOTA (European Organisation for Technical Assessment, www.eota.eu)

European Technical Assessment

ETA 15/0032
of 02/02/2015

Technical Assessment Body issuing the ETA and designated according to Article 29 of the Regulation (EU) No 305/2011: UL International (UK) Ltd

Trade name of the construction product

TYTAN B1 FIRE BOARD

Product family to which the construction product belongs

Fire Stopping and Sealing Product:
 • Penetration Seals

Manufacturer

Selena FM S.A.
 Ul. Strzegomska 2-4
 53-611 Wrocław, Poland
www.selena.com

Manufacturing plant(s)

A/003

This European Technical Assessment contains

36 pages including 1 Annex which forms an integral part of this assessment.

This European Technical Assessment is issued in accordance with regulation (EU) No 305/2011, on the basis of

ETAG 026-2, edition 2011, used as European Assessment Document (EAD).

Translations of this European Technical Assessment in other languages shall fully correspond to the original issued document and should be identified as such.

Communication of this European Technical Assessment, including transmission by electronic means, shall be in full. However, partial reproduction may be made, with the written consent of the issuing Technical Assessment Body. Any partial reproduction has to be identified as such.

Table of Contents

I.	SPECIFIC PARTS OF THE EUROPEAN TECHNICAL ASSESSMENT	3
1	Technical description of the product	3
2	Specification of the intended uses of the product in accordance with the applicable European Assessment Document (Hereinafter EAD): ETAG 026-2	3
3	Performance of the product and references to the methods used for its assessment	5
4	ASSESSMENT AND VERIFICATION OF CONSTANCY OF PERFORMANCE (HEREINAFTER AVCP) SYSTEM APPLIED, WITH REFERENCE TO ITS LEGAL BASE	6
5	Technical details necessary for the implementation of the AVCP system, as provided for in the applicable EAD	6
6	Issued on:	7
ANNEX A – Resistance to Fire Classification – TYTAN B1 FIRE BOARD		8
A.1	Rigid wall constructions according to 1.2.1 with wall thickness of minimum 150 mm	8
A.1.1	Cable penetration seal with 2x 60 mm thick TYTAN B1 FIRE BOARD 2-S	8
A.1.2	Cable penetration seal with 1x 60 mm thick TYTAN B1 FIRE BOARD 2-S	10
A.1.3	Pipe penetration seal with 2x 60 mm thick TYTAN B1 FIRE BOARD 2-S	11
A.1.4	Pipe penetration seal with 1x 60 mm thick TYTAN B1 FIRE BOARD 2-S	13
A.1.5	Pipe penetration seal with 1x TYTAN B1 FIRE BOARD 2-S	15
A.2	Rigid floor constructions according to 1.2.1 with floor thickness of minimum 150 mm	16
A.2.1	Cable penetration seal with 2x TYTAN B1 FIRE BOARD 2-S	16
A.2.2	Cable penetration seal with 1x TYTAN B1 FIRE BOARD 2-S	17
A.2.3	Pipe penetration seal with 2x TYTAN B1 FIRE BOARD 2-S	18
A.2.4	Pipe penetration seal with 1x TYTAN B1 FIRE BOARD 2-S	20
A.2.5	Pipe penetration seal with 1x TYTAN B1 FIRE BOARD 2-S	23
A.2.6	Pipe penetration seal with 1x TYTAN B1 FIRE BOARD 2-S	24
A.2.7	Pipe penetration seal with 2x TYTAN B1 FIRE BOARD 2-S	25
A.2.8	Pipe penetration seal with 2x TYTAN B1 FIRE BOARD 2-S (back to back)	26
A.3	Flexible wall constructions according to 1.2.1 with wall thickness of minimum 100 mm	28
A.3.1	Cable penetration seal with 2x TYTAN B1 FIRE BOARD 1-S	28
A.3.2	Pipe penetration seal with 2x TYTAN B1 FIRE BOARD 1-S	29
A.3.3	Pipe penetration seal with 2x TYTAN B1 FIRE BOARD 1-S	31
A.3.4	Pipe penetration seal with 2x TYTAN B1 FIRE BOARD 1-S	34
A.3.5	Plastic pipe penetration seal with 2x TYTAN B1 FIRE BOARD 1-S	36

I. SPECIFIC PARTS OF THE EUROPEAN TECHNICAL ASSESSMENT

1 Technical description of the product

- 1) TYTAN B1 FIRE BOARD is a coated mineral wool board used to reinstate the fire resistance performance of wall and floor constructions where they have been provided with apertures for the penetration of single or multiple services.
- 2) The TYTAN B1 FIRE BOARD is supplied coated on one face, referenced 1-S, or on both faces, referenced 2-S. The board or boards are then cut to allow the penetration of the required services, before being inserted into the aperture in the wall.
- 3) TYTAN B1 FIRE WRAPS are required to be used in conjunction with TYTAN B1 FIRE BOARD depending upon the required application and classification (see Annex B). TYTAN B1 FIRE WRAPS are the subject of a separate ETA which is not declared in the document for confidentiality reasons.
- 4) The applicant submitted a written declaration that TYTAN B1 FIRE BOARD does not contain substances which have to be classified as dangerous according to Directive 67/548/EEC and Regulation (EC) No 1272/2008 and listed in the "Indicative list on dangerous substances" of the EGDS - taking into account the installation conditions of the construction product and the release scenarios resulting from there.

In addition to the specific clauses relating to dangerous substances contained in this European technical Assessment, there may be other requirements applicable to the products falling within its scope (e.g. transposed European legislation and national laws, regulations and administrative provisions). In order to meet the provisions of the Construction Products Regulation, these requirements need also to be complied with, when and where they apply.

2 Specification of the intended uses of the product in accordance with the applicable European Assessment Document (Hereinafter EAD): ETAG 026-2

Detailed information and data is given in Annex A.

- 1) The intended use of TYTAN B1 FIRE BOARD is to reinstate the fire resistance performance of flexible wall, rigid wall and floor constructions where they are penetrated by various cables, metallic pipes, composite pipes and plastic pipes.
- 2) The specific elements of construction that the system TYTAN B1 FIRE BOARD may be used to provide a penetration seal in, are as follows:
 - a. Flexible walls: The wall must have a minimum thickness of 100 mm and comprise steel studs lined on both faces with minimum 2 layers of 12.5 mm thick boards.
 - b. Rigid walls: The wall must have a minimum thickness of 150 mm and comprise concrete, aerated concrete or masonry, with a minimum density of 650 kg/m³.
 - c. Rigid floors: The floor must have a minimum thickness of 150 mm and comprise aerated concrete or concrete with a minimum density of 650 kg/m³.

The supporting construction must be classified in accordance with EN 13501-2 for the required fire resistance period.

- 3) The System TYTAN B1 FIRE BOARD may be used to provide a penetration seal with cables, cable trays, metallic pipes, composite pipes and plastic pipes, with and without insulation (for details see Annex A).
- 4) The total amount of cross sections of services (including insulation) should not exceed 60% of the penetration area.
- 5) The system TYTAN B1 FIRE BOARD may be used to seal apertures in the separating element up to 2400mm wide by 1200mm high in a wall, and 2400mm by 1200 mm in a floor. The minimum permitted separation between adjacent seals/apertures is 200mm. Services within the system TYTAN B1 FIRE BOARD seal do not require a minimum separation, except where specifically detailed in Annex A.
- 6) Services in floors shall be supported at 250mm and 400mm from the top face. Services in walls shall be supported at 270mm and 470mm from both faces of the wall.
- 7) The provisions made in this European Technical Assessment are based on an assumed working life of the TYTAN B1 FIRE BOARD of 10 years, provided that the conditions laid down in the product datasheet for the packaging/transport/ storage/installation/use/repair are met. The indications given on the working life cannot be interpreted as a guarantee given by the producer, but are to be regarded only as a means for choosing the right products in relation to the expected economically reasonable working life of the works.
- 8) Type Z₂: Intended for uses in internal conditions with humidity lower than 85 % RH excluding temperatures below 0°C, without exposure to rain or UV.

3 Performance of the product and references to the methods used for its assessment

Product-type: Sealant		Intended use: Penetration Seal	
Basic requirement for construction work	Essential characteristic	Performance	
	Mechanical resistance and stability		
-	None	Not relevant	
Safety in case of fire			
EN 13501-1	Reaction to fire	Class F (untested)	
EN 13501-2	Resistance to fire	Annex A	
Hygiene, health and environment			
EN 1026:2000	Air permeability (material property)	No performance determined	
ETAG 026-2, Annex C	Water permeability (material property)	No performance determined	
Declaration of manufacturer	Release of dangerous substances	Declaration of manufacturer	
Safety in use			
EOTA TR 001:2003	Mechanical resistance and stability	No performance determined	
EOTA TR 001:2003	Resistance to impact/movement	No performance determined	
EOTA TR 001:2003	Adhesion	No performance determined	
Protection against noise			
EN 10140-2/ EN ISO 717-1	Airborne sound insulation	No performance determined	
Energy economy and heat retention			
EN 12664, EN 12667 or EN 12939	Thermal properties	No performance determined	
EN ISO 12572 EN 12086	Water vapour permeability	No performance determined	
General aspects relating to fitness for use			
EN 13162 or EN 14303, EN ISO 1519	Durability and serviceability	Z ₂	

4 ASSESSMENT AND VERIFICATION OF CONSTANCY OF PERFORMANCE (HEREINAFTER AVCP) SYSTEM APPLIED, WITH REFERENCE TO ITS LEGAL BASE

According to the decision 1999/454/EC – Commission Decision of date 22nd June 1999 on the procedure for attesting the conformity of construction products pursuant to Article 20(2) of Council Directive 89/106/EEC as regards fire stopping, fire sealing and fire protective products, published in the Official Journal of the European Union (OJEU) L178/52 of 14/07/1999, see <http://eur-lex.europa.eu/JOIndex.do> of the European Commission¹, as amended, the system(s) of assessment and verification of constancy of performance (see Annex V to Regulation (EU) No 305/2011) given in the following table(s) applies (apply).

Product(s)	Intended use(s)	Level(s) or class(es)	System(s)
Fire stopping and Fire Sealing Products	For fire compartmentation and/or fire protection or fire performance	Any	1

5 Technical details necessary for the implementation of the AVCP system, as provided for in the applicable EAD

Tasks of the manufacturer:

Factory production control

The manufacturer shall exercise permanent internal control of production. All the elements, requirements and provisions adopted by the manufacturer shall be documented in a systematic manner in the form of written policies and procedures, including records of results performed. This production control system shall ensure that the product is in conformity with this European Technical Assessment.

The manufacturer may only use initial / raw / constituent materials stated in the technical documentation of this European Technical Assessment.

The factory production control shall be in accordance with the Control Plan of 8th April 2013 relating to the European technical assessment ETA 15/0032 issued on 02/02/2015 which is part of the technical documentation of this European technical assessment. The "Control Plan" is laid down in the context of the factory production control system operated by the manufacturer and deposited at UL International (UK) Ltd.

The results of factory production control shall be recorded and evaluated in accordance with the provisions of the Control Plan.

¹ Official Journal of the European Communities L178/52 of 14/7/1999

Other tasks of the manufacturer

Additional information

The manufacturer shall provide a technical data sheet and an installation instruction with the following minimum information:

(a) Technical data sheet:

- Field of application:
- Building elements for which the penetration seal is suitable, type and properties of the building elements like minimum thickness, density, and - in case of lightweight constructions – the construction requirements.
- Limits in size, minimum thickness etc. of the penetration seal
- Construction of the penetration seal including the necessary components and additional products (e.g. backfilling material) with clear indication whether they are generic or specific.
- Services which the penetration seal is suitable, type and properties of the services like material, diameter, thickness etc. in case of pipes including insulation materials; necessary/allowed supports/fixings (e.g. cable trays)

(b) Installation instruction:

- Steps to be followed
- Procedure in case of retrofitting
- Stipulations on maintenance, repair and replacement

6 Issued on:

2nd February 2015

Report by:



C. Johnson
Staff Engineer
Building and Life Safety Technologies

Reviewed by:



C. W. Miles
Business Manager – Europe & Latin America
Building and Life Safety Technologies

For and on behalf of UL International (UK) Ltd.

ANNEX A – Resistance to Fire Classification – TYTAN B1 FIRE BOARD

A.1 Rigid wall constructions according to 1.2.1 with wall thickness of minimum 150 mm

A.1.1 Cable penetration seal with 2x 60 mm thick TYTAN B1 FIRE BOARD 2-S

Penetration Seal: Cables fitted at any position within the aperture (min. separation 25 mm from seal edges), with 60 mm TYTAN B1 FIRE BOARD 2-S to both sides of the wall.

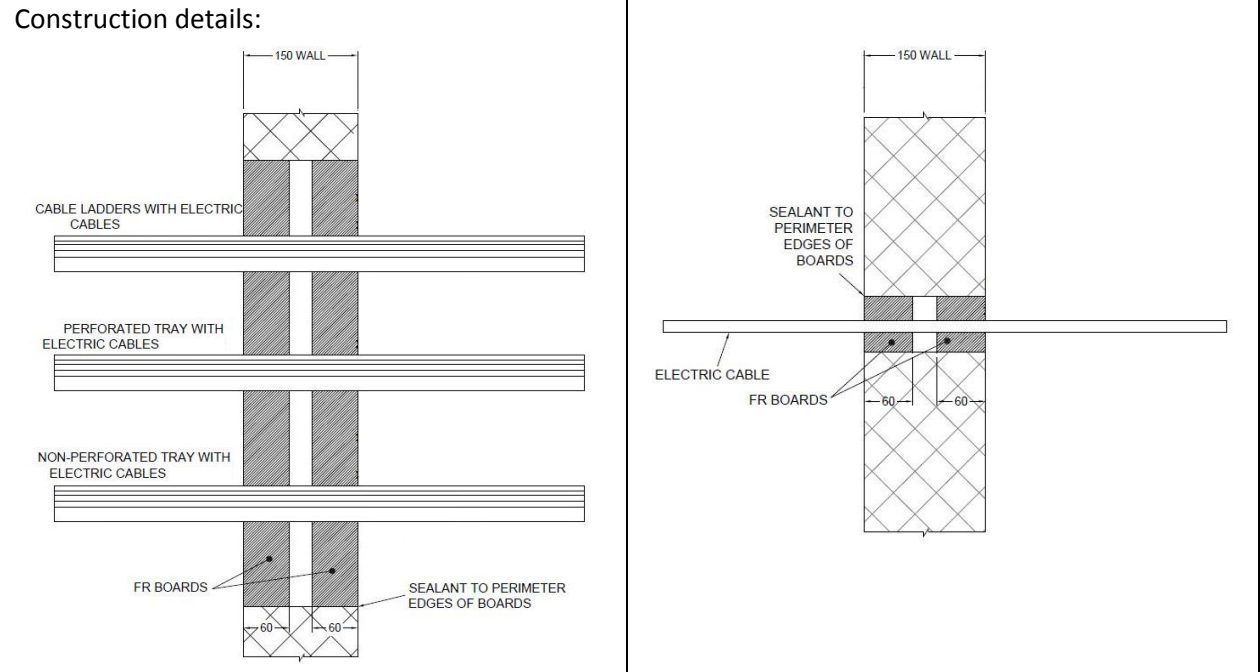

A.1.1.1 Double side penetration seal with cables

Services	Maximum aperture	Classification
None (blank)	2400 mm wide x 1200 mm high	E 240, EI 180
Single electrical cables up to 21 mm \varnothing		
Electrical cables up to 80 mm \varnothing (single, bundled and on trays)		E 180, EI 60
Telecommunication cables up to 21 mm \varnothing (single or bundles up to 100 mm \varnothing)		E 180, EI 120
Steel cable trays & ladders		E 180, EI 60
PVC conduit up to 16 mm \varnothing		EI 180 C/U, EI 180 C/C

A.1.2 Cable penetration seal with 1x 60 mm thick TYTAN B1 FIRE BOARD 2-S

Penetration Seal: Cables (single) fitted at any position within the aperture, with minimum 30 mm separation from seal edge and 100 mm from other services, with TYTAN B1 FIRE BOARD 2-S positioned to either face of the wall (or anywhere in between).

Construction details:

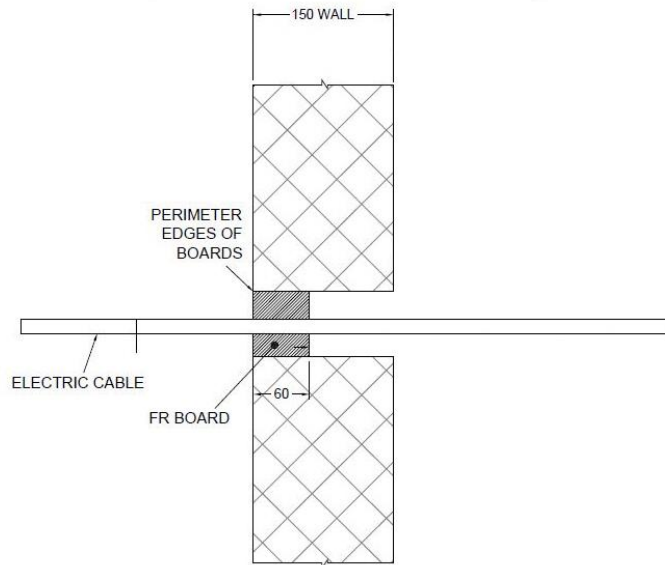

A.1.2.1 Single side penetration seal with cables

Services	Maximum aperture	Classification
None (blank)	2400 mm wide x 1200 mm high	E 240, EI 90
Single A1 cable = 5 x 1.5 mm ² core HD603.3 electrical cable with PVC insulation, PVC sheath and 14 mm diameter		
Single A2 cable = 5 x 1.5 mm ² core HD22.4 electrical cable with EPR insulation, PO sheath and 11.2-14.4 mm diameter		
Single A3 cable = 5 x 1.5 mm ² core HD604.5 electrical cable with XLPE insulation, EVA sheath and 13 mm diameter	70 x 70 mm	EI 240
Single A1 cable = 5 x 1.5 mm ² core HD603.3 electrical cable with PVC insulation, PVC sheath and 14 mm diameter		
Single A2 cable = 5 x 1.5 mm ² core HD22.4 electrical cable with EPR insulation, PO sheath and 11.2-14.4 mm diameter		
Single A3 cable = 5 x 1.5 mm ² core HD604.5 electrical cable with XLPE insulation, EVA sheath and 13 mm diameter		

A.1.3 Pipe penetration seal with 2x 60 mm thick TYTAN B1 FIRE BOARD 2-S

Penetration Seal: 1000 mm (min.) LI (Local Interrupted) or CI (Continuous Interrupted) insulated metallic pipes (single) fitted at any position within the aperture (min. separation 30 mm from seal edges, with 60 mm TYTAN B1 FIRE BOARD to both sides of the wall).

Construction details:

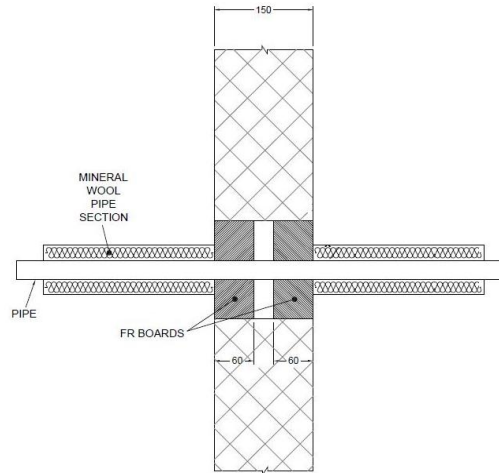

A.1.3.1 Double side penetration seal with pipes

Services	Maximum aperture	Insulation	Classification
Mild or stainless steel pipe			
40 mm diameter/1.5-14.2 mm wall*	100 x 100 mm	20 mm Stone wool insulation 80 kg/m ³	EI 240 C/U
40 mm diameter/1.5-14.2 mm wall*	2400 mm wide x 1200 mm high	30 mm Stone wool insulation 80 kg/m ³	E 240 C/U, EI 180 C/U
40 mm diameter/1.5-14.2 mm wall*			
50 mm diameter/1.7-14.2 mm wall*			
60 mm diameter/1.9-14.2 mm wall*			
75 mm diameter/2.2-14.2 mm wall*			
90 mm diameter/2.5-14.2 mm wall*			
100 mm diameter/2.7-14.2 mm wall*			
115 mm diameter/3-14.2 mm wall*			
140 mm diameter/3.5-14.2 mm wall*			
165 mm diameter/ 3.9-14.2 mm wall*			
180 mm diameter/ 4.2-14.2 mm wall*			
200 mm diameter/ 4.6-14.2 mm wall*			
219 mm diameter/ 5.0-14.2 mm wall*			
			E 240 C/U, EI 90 C/U

* Typical pipe diameters shown, see below graph for intermediate sizes

Pipe diameter vs Wall thickness

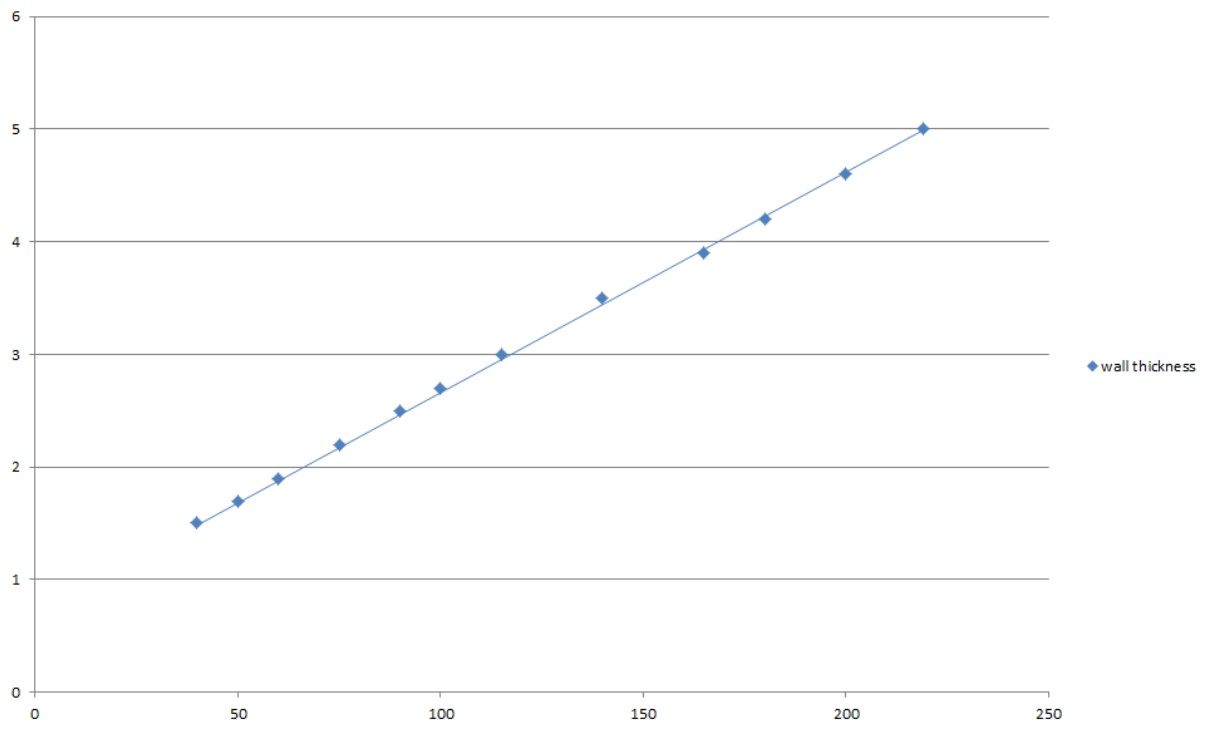

A.1.4 Pipe penetration seal with 1x 60 mm thick TYTAN B1 FIRE BOARD 2-S

Penetration Seal: 1000 mm (min.)* LI (Local Interrupted) or CI (Continuous Interrupted) insulated metallic and composite pipes (single) fitted at any position within the aperture (min. separation 30 mm from seal edges, with 60 mm TYTAN B1 FIRE BOARD to one side of the wall).

Construction details:

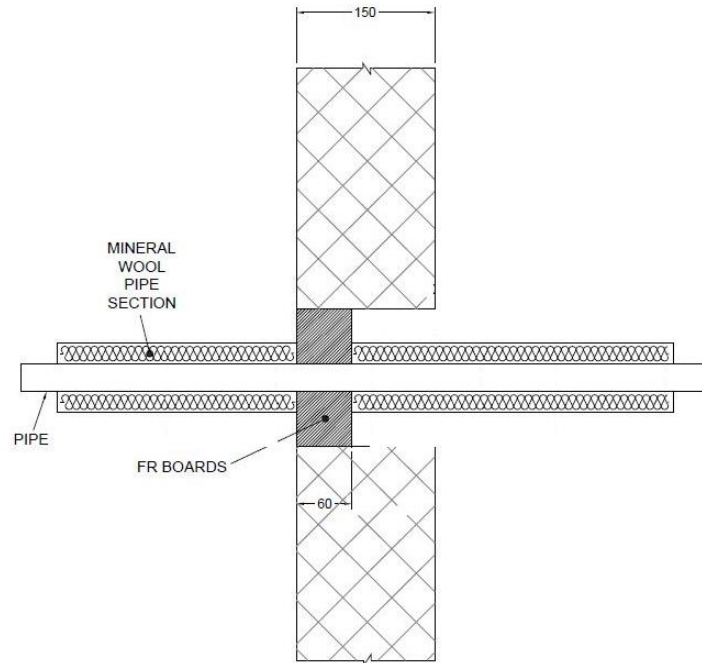

* 600 mm long insulation required for Alupex pipes

A.1.4.1 Single side penetration seal with pipes

Services	Maximum Aperture	Insulation	Classification
Up to 12 mm diameter Copper pipe 0.9-14.2 mm wall	70 x 70 mm	20 mm Stone wool insulation 80 kg/m ³	EI 240 C/U
Up to 54 mm diameter Copper pipe 0.9-14.2 mm wall	115 x 115 mm		E 240 C/U, EI 120 C/U
75 mm diameter Alupex composite pipe 7.5 mm diameter	200 x 200 mm	30 mm Stone wool insulation 80 kg/m ³	EI 120 C/C
Up to 54 mm diameter Copper pipe 0.9-14.2 mm wall	2400 mm wide x 1200 mm high	20 mm Stone wool insulation 80 kg/m ³	E 240 C/U, EI 90 C/U
75 mm diameter Alupex composite pipe 7.5 mm diameter		30 mm Stone wool insulation 80 kg/m ³	E 120 C/C, EI 90 C/C

Services	Maximum Aperture	Insulation	Classification
Mild or stainless steel pipe			
40 mm diameter/1.5-14.2 mm wall*	100 x 100 mm	20 mm Stone wool insulation 80 kg/m ³	EI 240 C/U
40 mm diameter/1.5-14.2 mm wall*			E 240 C/U, EI 90 C/U
40 mm diameter/1.5-14.2 mm wall*	2400 mm wide by 1200 mm high	30 mm Stone wool insulation 80 kg/m ³	E 90 C/U, EI 45 C/U
50 mm diameter/1.7-14.2 mm wall*			
60 mm diameter/1.9-14.2 mm wall*			
75 mm diameter/2.2-14.2 mm wall*			
90 mm diameter/2.5-14.2 mm wall*			
100 mm diameter/2.7-14.2 mm wall*			
115 mm diameter/3-14.2 mm wall*			
140 mm diameter/3.5-14.2 mm wall*			
165 mm diameter/ 3.9-14.2 mm wall*			
180 mm diameter/ 4.2-14.2 mm wall*			
200 mm diameter/ 4.6-14.2 mm wall*			
219 mm diameter/ 5.0-14.2 mm wall*			

* Typical pipe diameters shown, see below graph for intermediate sizes

Pipe diameter vs Wall thickness

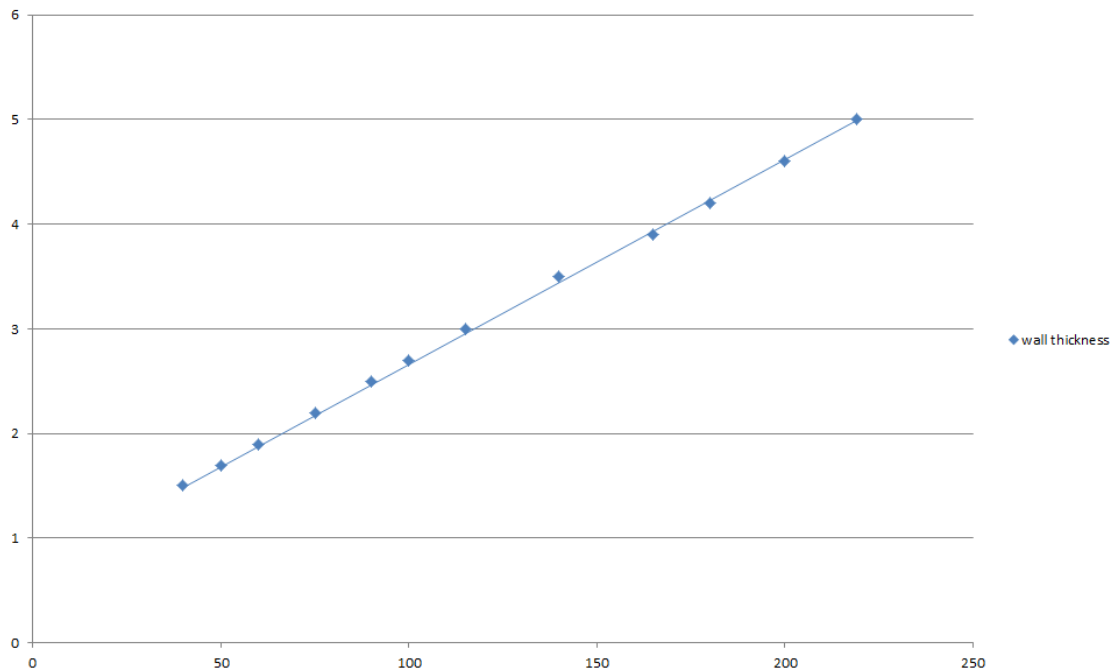

A.1.5 Pipe penetration seal with 1x TYTAN B1 FIRE BOARD 2-S

Penetration Seal: CS (Continuous Sustained) insulated metallic pipes fitted at any position within the aperture (min. separation 40 mm from seal edges and 100 mm from other services), with 60 mm TYTAN B1 FIRE BOARD 2-S to either side of the wall (or anywhere in between). TYTAN B1 FIRE WRAPS are required to be fitted around combustible pipe insulation. Maximum aperture size 2400 mm x 1200 mm

Construction details:

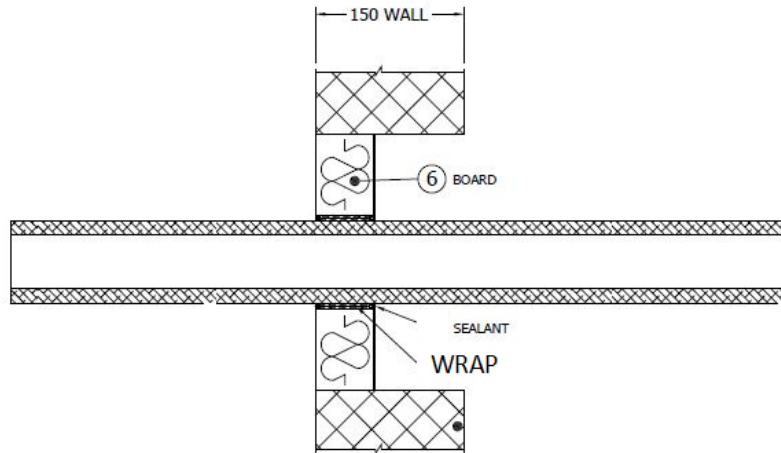

A.1.5.1 Single side penetration seal with pipes

Services	Wrap	Insulation	Classification
Mild or stainless steel pipe			
165 mm diameter/ 4.5-14.2 mm wall	50 x 1.8 mm TYTAN B1 FIRE WRAP fitted centrally	9-25 mm Kaiflex ST/KK insulation	E 120 U/C, E 120 C/U, E 120 C/C, EI 45 U/C, EI 45 C/U, EI 45 C/C
219 mm diameter/ 5-14.2 mm wall	Not required	30 mm stone wool 80 kg/m ³	E 240 U/C, E 240 C/U, E 240 C/C, EI 60 U/C, EI 60 C/U, EI 60 C/C

A.2 Rigid floor constructions according to 1.2.1 with floor thickness of minimum 150 mm

A.2.1 Cable penetration seal with 2x TYTAN B1 FIRE BOARD 2-S

Penetration Seal: Cables fitted at any position within the aperture (min. separation 30 mm from seal edges), with 60 mm TYTAN B1 FIRE BOARD 2-S to both sides of the floor.

Construction details:

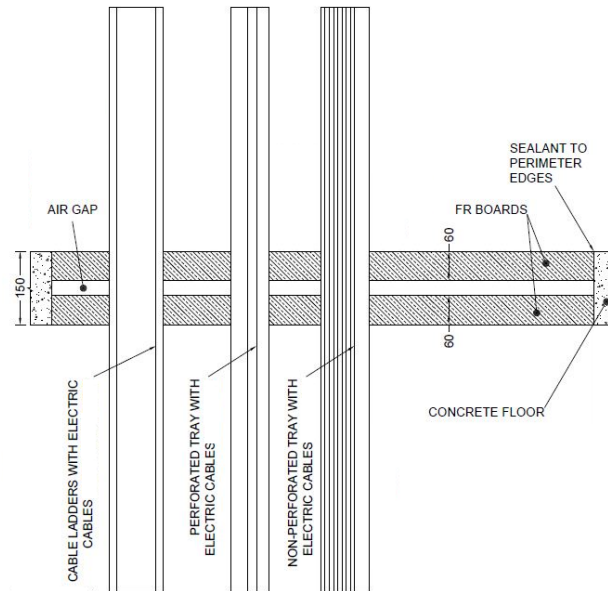

A.2.1.1 Double side penetration seal with cables

Services	Maximum aperture	Classification
None (blank)	2400 mm x 1200 mm	E 180, EI 120
Electrical cables up to 21 mm \varnothing (single, bundled and on trays)		EI 120
Electrical cables up to 80 mm \varnothing (single, bundled and on trays)		E 120, EI 60
Telecommunication cables up to 21 mm \varnothing (single or bundles up to 100 mm \varnothing)		EI 120
Steel cable trays & ladders		E 120, EI 60
Non-sheathed wires up to 24 mm \varnothing		E 180, EI 45
PVC conduit up to 16 mm \varnothing		E 120 C/U, E 120 C/C, EI 90 C/U, EI 90 C/C

A.2.2 Cable penetration seal with 1x TYTAN B1 FIRE BOARD 2-S

Penetration Seal: Cables fitted at any position within the aperture (min. separation 100 mm from seal edges), with TYTAN B1 FIRE BOARD 2-S positioned to either face of the floor (or anywhere in between).

Construction details:

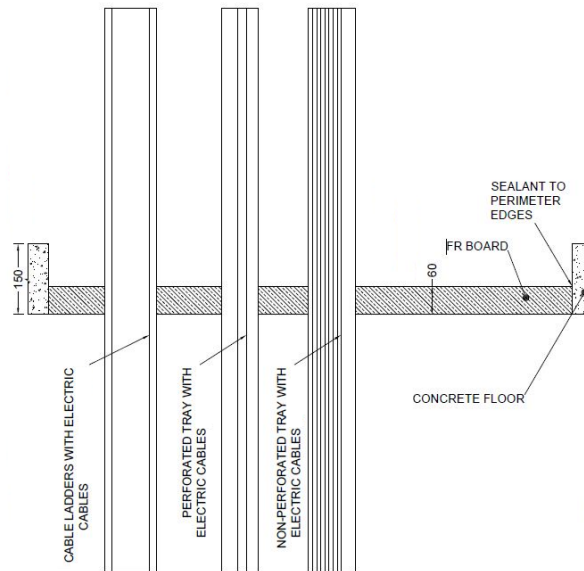

A.2.2.1 Single side penetration seal with cables

Services	Maximum aperture	Classification
None (blank)	2400 mm x 1200 mm	E 120, EI 90
Single* electrical cables up to 21 mm \emptyset		E 120, EI 30
Single* electrical cables up to 21 mm \emptyset	600 mm x 1200 mm	E 240, EI 30
Electrical cables up to 21 mm \emptyset (single, bundled and on trays)	2400 mm x 1200 mm	E 90, EI 45
Electrical cables up to 80 mm \emptyset (single, bundled and on trays)		E 90, EI 30
Telecommunication cables up to 21 mm \emptyset (single or bundles up to 100 mm \emptyset)		EI 45
Steel cable trays & ladders		EI 45
Non-sheathed wires up to 17 mm \emptyset		E 45, EI 30
Non-sheathed wires up to 24 mm \emptyset		E 45, EI 20
PVC conduit up to 16 mm \emptyset		EI 45 C/U, EI 45 C/C
Steel or copper conduit up to 16 mm \emptyset		E 45 C/U, EI 15 C/U

A.2.3 Pipe penetration seal with 2x TYTAN B1 FIRE BOARD 2-S

Penetration Seal: 1000 mm (min.) LI (Local Interrupted) or CI (Continuous Interrupted) insulated metallic pipes (single) fitted at any position within the aperture (min. separation 30 mm from seal edges, with 2 layers of 60 mm TYTAN B1 FIRE BOARD 2-S together within the floor).

Construction details:

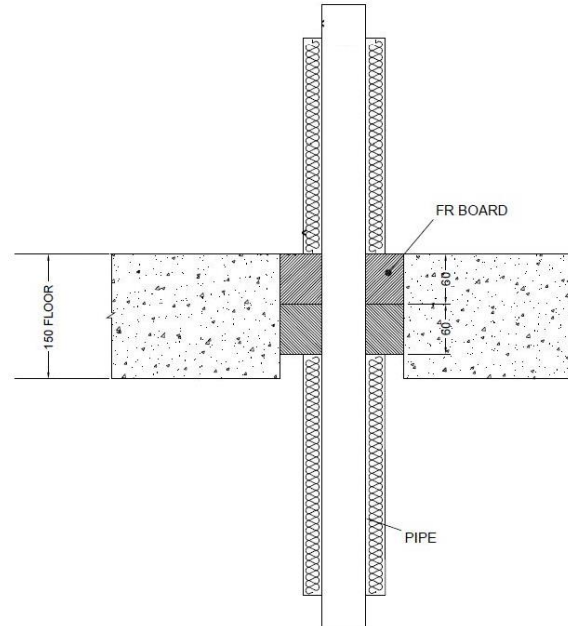

A.2.3.1 Two layer penetration seal with pipes

Services	Maximum aperture	Insulation	Classification
Mild or stainless steel pipe			
40 mm diameter/1.5-14.2 mm wall*	280 x 280 mm	20 mm Stone wool insulation 80 kg/m ³	EI 240 C/U
40 mm diameter/1.5-14.2 mm wall*	2400 x 1200 mm	30 mm Stone wool insulation 80 kg/m ³	E 180 C/U, EI 120 C/U
40 mm diameter/1.5-14.2 mm wall*			
50 mm diameter/1.7-14.2 mm wall*			
60 mm diameter/1.8-14.2 mm wall*			
75 mm diameter/2.1-14.2 mm wall*			
90 mm diameter/2.3-14.2 mm wall*			
100 mm diameter/2.5-14.2 mm wall*			
115 mm diameter/2.8-14.2 mm wall*			
140 mm diameter/3.2-14.2 mm wall*			
165 mm diameter/ 3.6-14.2 mm wall*			
180 mm diameter/ 3.9-14.2 mm wall*			
200 mm diameter/ 4.2-14.2 mm wall*			
219 mm diameter/ 4.5-14.2 mm wall*			
			E 180 C/U, EI 60 C/U

* Typical pipe diameters shown, see below graph for intermediate sizes

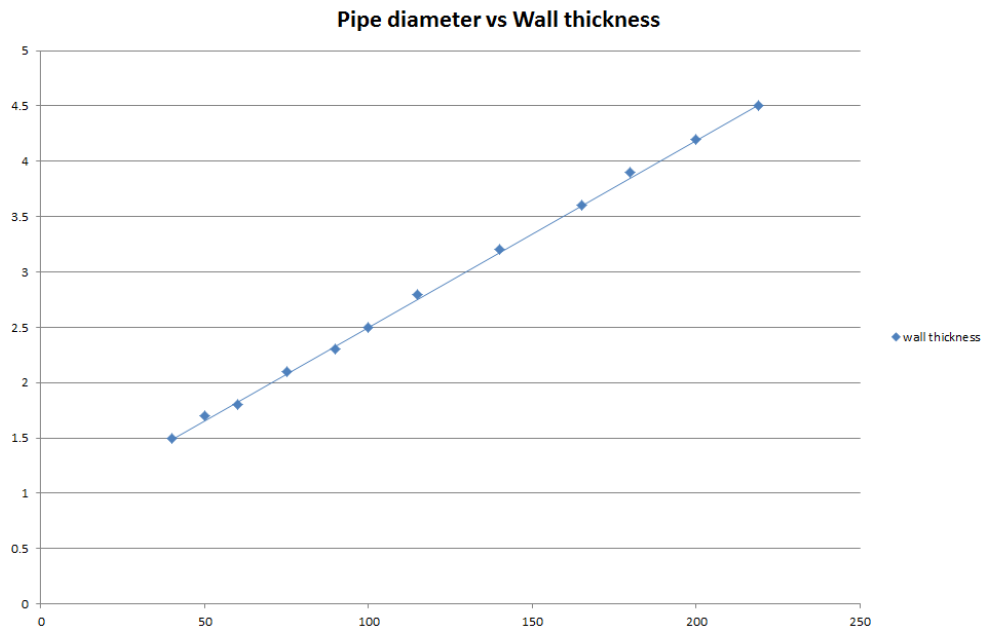

A.2.4 Pipe penetration seal with 1x TYTAN B1 FIRE BOARD 2-S

Penetration Seal: 1000 mm (min.)* LI (Local Interrupted) or CI (Continuous Interrupted) insulated metallic pipes (single) fitted at any position within the aperture (min. separation 30 mm from seal edges), with 60 mm TYTAN B1 FIRE BOARD 2-S to either side of the floor (or anywhere in between).

Construction details:

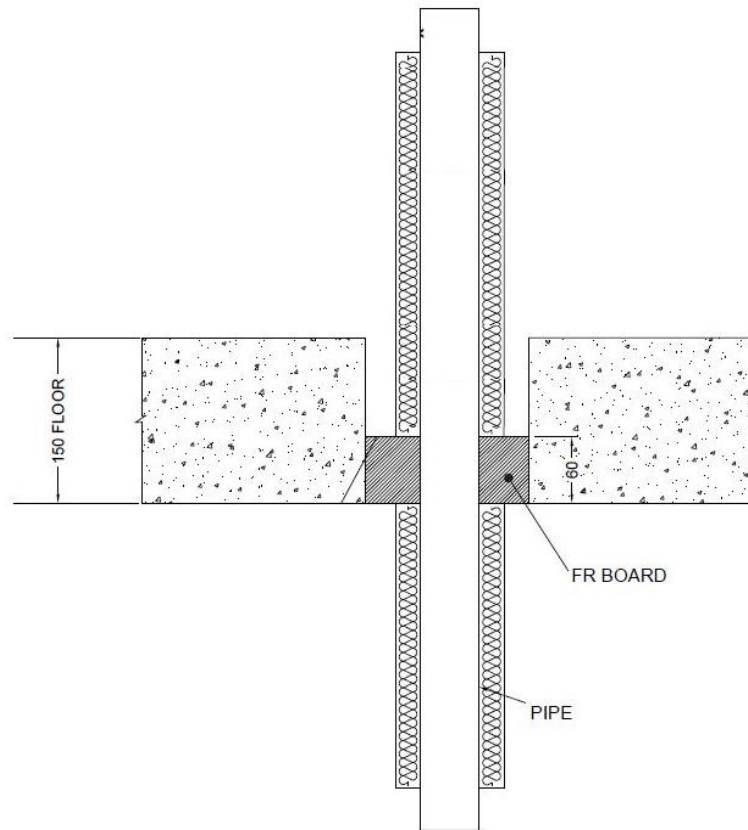

A.2.4.1 Single side penetration seal with pipes

Services	Maximum Aperture	Insulation	Classification
Up to 12 mm diameter Copper pipe 0.9-14.2 mm wall	70 x 70 mm	20 mm Stone wool insulation 80 kg/m ³	E 240 C/U, EI 45 C/U
Up to 54 mm diameter Copper pipe 0.9-14.2 mm wall	115 x 115 mm		E 240 C/U
	2400 mm x 1200 mm		E 120 C/U
114 mm diameter mild or stainless steel pipe 11-14.2 mm wall	600 x 1200	None	E 240 C/C, EI 20 C/C
	2400 mm x 1200 mm		E 120 C/C, EI 20 C/C

Services	Maximum Aperture	Insulation	Classification
Mild or stainless steel pipe			
40 mm diameter/1.5-14.2 mm wall*	600 x 1200 mm	20 mm Stone wool insulation 80 kg/m ³	E 240 C/U, EI 60 C/U
40 mm diameter/1.5-14.2 mm wall*		30 mm Stone wool insulation 80 kg/m ³	E 240 C/U, EI 90 C/U
50 mm diameter/1.7-14.2 mm wall*			
60 mm diameter/1.8-14.2 mm wall*			
75 mm diameter/2.1-14.2 mm wall*			
90 mm diameter/2.3-14.2 mm wall*			
100 mm diameter/2.5-14.2 mm wall*			
115 mm diameter/2.8-14.2 mm wall*			
140 mm diameter/3.2-14.2 mm wall*			
165 mm diameter/ 3.6-14.2 mm wall*			
180 mm diameter/ 3.9-14.2 mm wall*			
200 mm diameter/ 4.2-14.2 mm wall*			
219 mm diameter/ 4.5-14.2 mm wall*			
40 mm diameter/1.5-14.2 mm wall*	2400 mm wide by 1200 mm high	20 mm Stone wool insulation 80 kg/m ³	E 120 C/U, EI 60 C/U
40 mm diameter/1.5-14.2 mm wall*		30 mm Stone wool insulation 80 kg/m ³	E 120 C/U, EI 90 C/U
50 mm diameter/1.7-14.2 mm wall*			
60 mm diameter/1.8-14.2 mm wall*			
75 mm diameter/2.1-14.2 mm wall*			
90 mm diameter/2.3-14.2 mm wall*			
100 mm diameter/2.5-14.2 mm wall*			
115 mm diameter/2.8-14.2 mm wall*			
140 mm diameter/3.2-14.2 mm wall*			
165 mm diameter/ 3.6-14.2 mm wall*			
180 mm diameter/ 3.9-14.2 mm wall*			
200 mm diameter/ 4.2-14.2 mm wall*			
219 mm diameter/ 4.5-14.2 mm wall*			

* Typical pipe diameters shown, see below graph for intermediate sizes

Pipe diameter vs Wall thickness

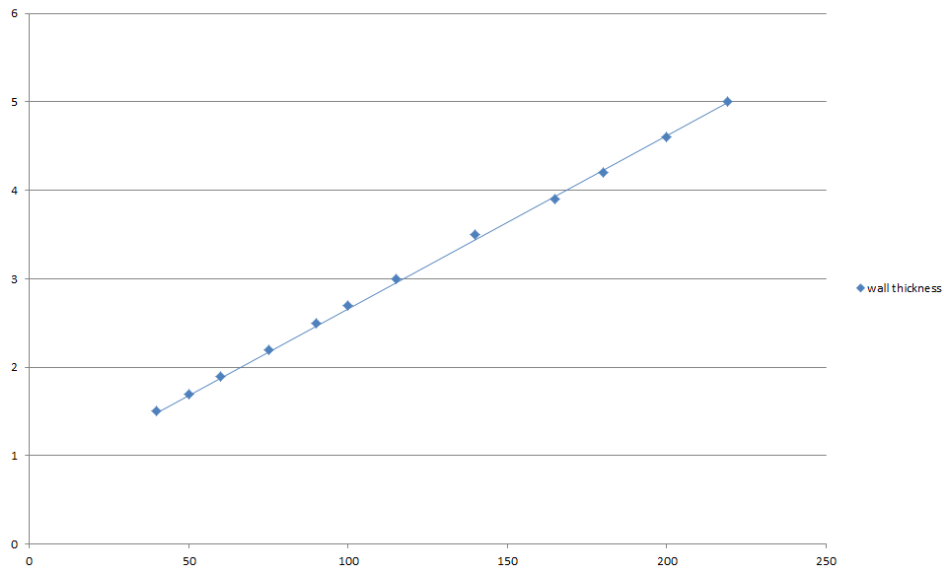

Services	Maximum Aperture	Insulation (minimum)	Classification
Geberit Mepla MLC (PE-Xb/Aluminium/PE-HD pipe)			
16 mm diameter/2.25 mm wall	75 x 75 mm		E 240 C/C, EI 180 C/C
16 mm diameter/2.25 mm wall	600 x 1200 mm	500 mm long, 20 mm Stone wool insulation 80 kg/m ³	E 240 C/C, EI 90 C/C
20 mm diameter/2.5 mm wall			
26 mm diameter/3 mm wall			
32 mm diameter/3 mm wall			
40 mm diameter/3.5 mm wall			
50 mm diameter/4 mm wall			
63 mm diameter/4.5 mm wall			
75 mm diameter/4.7 mm wall			
16 mm diameter/2.25 mm wall	2400 mm x 1200 mm	500 mm long, 20 mm Stone wool insulation 80 kg/m ³	E 120 C/C, EI 90 C/C
20 mm diameter/2.5 mm wall			
26 mm diameter/3 mm wall			
32 mm diameter/3 mm wall			
40 mm diameter/3.5 mm wall			
50 mm diameter/4 mm wall			
63 mm diameter/4.5 mm wall			
75 mm diameter/4.7 mm wall			

A.2.5 Pipe penetration seal with 1x TYTAN B1 FIRE BOARD 2-S

Penetration Seal: Combustible pipes fitted at any position within the aperture (min. separation 40 mm from seal edges and 100 mm from other services), with 50 mm TYTAN B1 FIRE BOARD 2-S at mid-depth of the floor. TYTAN B1 FIRE WRAPS are required to be fitted around combustible pipe insulation. Maximum aperture size 400 mm x 400 mm

Construction details:

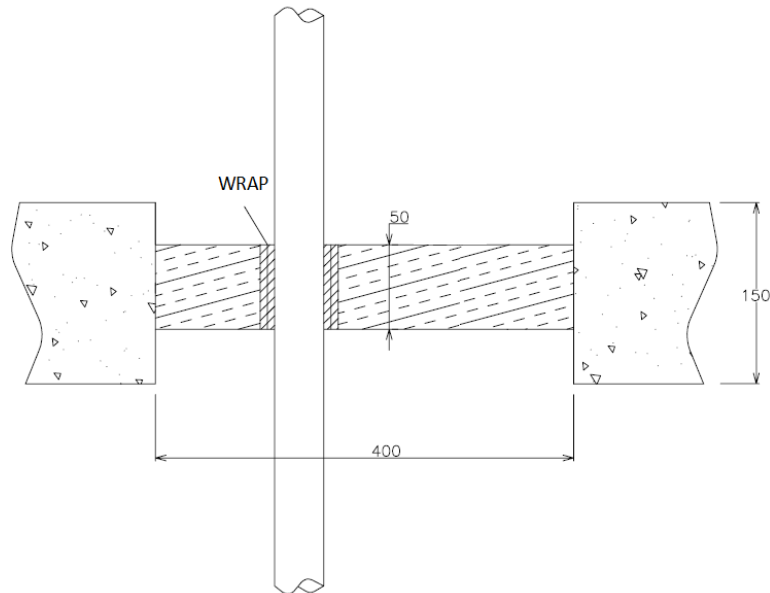

A.2.5.1 Central penetration seal with pipes

Services	Wrap	Classification
PVC-U pipe according to EN 1329-1, EN 1452-1 and EN 1453-1* 110 mm diameter/ 3.4mm wall	50 x 3.6 mm TYTAN B1 FIRE WRAP	EI 90 U/C, EI 90 C/C

A.2.6 Pipe penetration seal with 1x TYTAN B1 FIRE BOARD 2-S

Penetration Seal: CS (Continuous Sustained) insulated metallic pipes fitted at any position within the aperture (min. separation 40 mm from seal edges and 100 mm from other services), with 60 mm TYTAN B1 FIRE BOARD 2-S to either side of the floor (or anywhere in between). TYTAN B1 FIRE WRAPS are required to be fitted around combustible pipe insulation. Maximum aperture size 2400 mm x 1200 mm

Construction details:

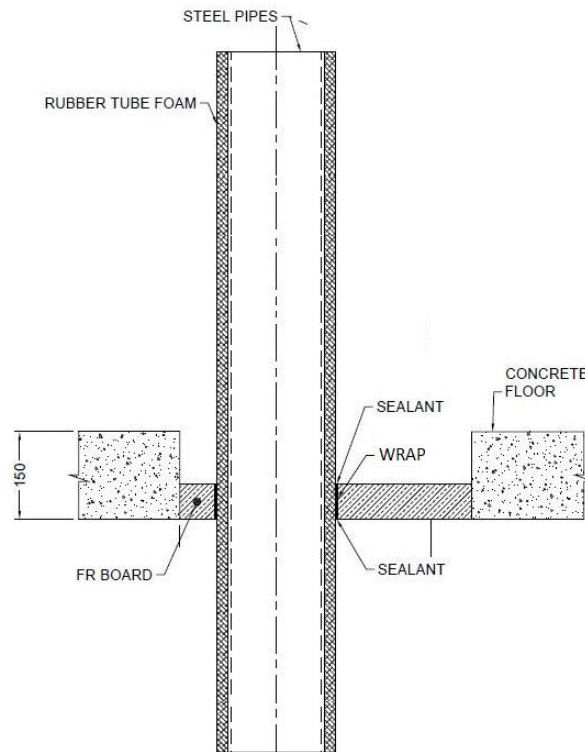

A.2.6.1 Single side penetration seal with pipes

Services	Wrap	Insulation	Classification
Mild or stainless steel pipe			
165 mm diameter/ 4.5-14.2 mm wall	50 x 3.6 mm TYTAN B1 FIRE WRAP fitted at bottom of seal	13 mm Kaiflex ST insulation	E 90 C/U, EI 45 C/U
		19 mm Kaiflex ST insulation	EI 90 C/U
	Not required	25-40 mm stone wool 80 kg/m ³	E 90 C/U, EI 60 C/U

A.2.7 Pipe penetration seal with 2x TYTAN B1 FIRE BOARD 2-S

Penetration Seal: CS (Continuous Sustained) insulated metallic pipes fitted at any position within the aperture (min. separation 40 mm from seal edges and 100 mm from other services), with 60 mm TYTAN B1 FIRE BOARD 2-S to both sides of the floor. TYTAN B1 FIRE WRAPS are required to be fitted around combustible pipe insulation at the soffit. Maximum aperture size 2400 mm x 1200 mm

Construction details:

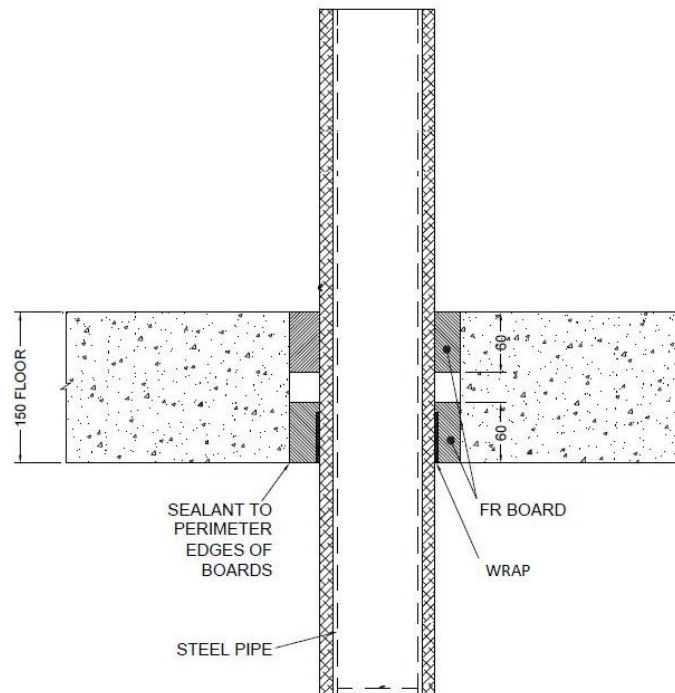

A.2.7.1 Double side penetration seal with pipes

Services	Wrap	Insulation	Classification
Mild or stainless steel pipe	50 x 1.8 mm TYTAN B1 FIRE WRAP	13 mm Kaiflex ST insulation	E 180 C/U, EI 120 C/U
40 mm diameter/ 1-14.2 mm wall			

A.2.8 Pipe penetration seal with 2x TYTAN B1 FIRE BOARD 2-S (back to back)

Penetration Seal: CS (Continuous Sustained) insulated metallic and composite pipes fitted at any position within the aperture (min. separation 40 mm from seal edges and 100 mm from other services), with two layers of 60 mm TYTAN B1 FIRE BOARD 1-S installed together to either side of the floor (or anywhere in between). TYTAN B1 FIRE WRAPs are required to be fitted around combustible pipe insulation at the bottom of the seal. Maximum aperture size 2400 mm x 1200 mm

Construction details:

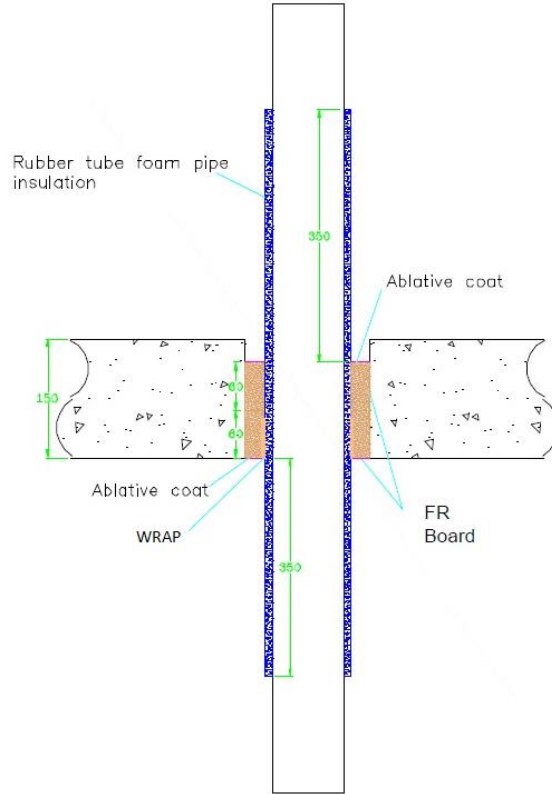

A.2.8.1 Back to back penetration seal with pipes

Services	Wrap	Insulation	Classification
Copper pipe	50 x 3.6 mm TYTAN B1 FIRE WRAP fitted to both sides of the seal	9-13 mm Kaiflex ST insulation	E240 C/C, EI 60 C/C
12-54 mm diameter/1-1.2 mm wall		13-25 mm Kaiflex ST insulation	E 180 C/C, EI 45 C/C
12-54 mm diameter/1-1.2 mm wall			
Geberit Mepla MLC (PE-Xb/Aluminium/PE-HD pipe)			
16 mm diameter/2.25 mm wall	50 x 3.6 mm TYTAN B1 FIRE WRAP fitted to both sides of the seal	9 mm Kaiflex ST insulation	EI 120 C/C
20 mm diameter/2.5 mm wall			
26 mm diameter/3 mm wall			
32 mm diameter/3 mm wall			
40 mm diameter/3.5 mm wall			
50 mm diameter/4 mm wall			
63 mm diameter/4.5 mm wall			
75 mm diameter/4.7 mm wall			
16 mm diameter/2.25 mm wall		13-25 mm Kaiflex ST insulation	E 60 C/C, EI 45 C/C
20 mm diameter/2.5 mm wall			
26 mm diameter/3 mm wall			
32 mm diameter/3 mm wall			
40 mm diameter/3.5 mm wall			
50 mm diameter/4 mm wall			
63 mm diameter/4.5 mm wall			
75 mm diameter/4.7 mm wall			

A.3 Flexible wall constructions according to 1.2.1 with wall thickness of minimum 100 mm

A.3.1 Cable penetration seal with 2x TYTAN B1 FIRE BOARD 1-S

Penetration Seal: Cables fitted at any position within the aperture (min. separation 25 mm from seal edges), with 50 mm TYTAN B1 FIRE BOARD 1-S to both sides of the wall.

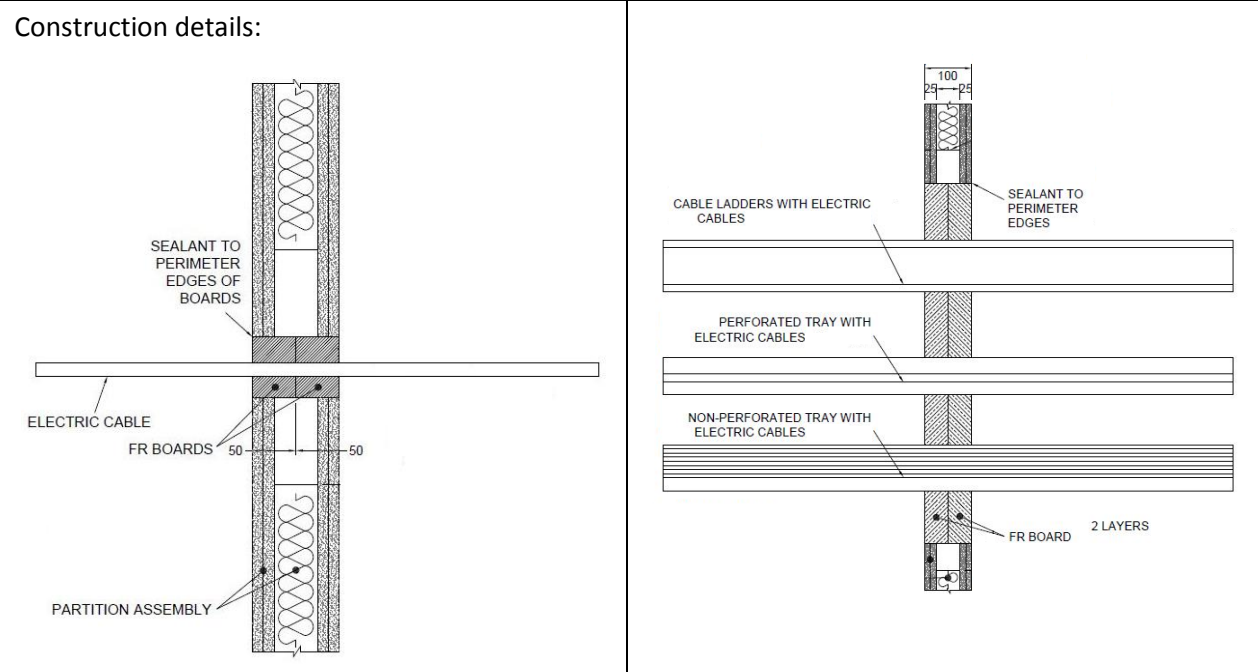

Note: Insulated metal pipes may also be included within the same seal as cables subject to minimum 100 mm separation. See separate classification for pipes.

A.3.1.1 Double side penetration seal with cables

Services	Maximum aperture	Classification
None (blank)	2400 mm wide x 1200 mm high	EI 120
Single electrical cables up to 21 mm \varnothing		E 120, EI 60
Electrical cables up to 80 mm \varnothing (single, bundled and on trays)		EI 60
Telecommunication cables up to 21 mm \varnothing (single or bundles up to 100 mm \varnothing)		
Steel cable trays & ladders		
Steel conduit up to 16 mm \varnothing		EI 60 C/U
copper conduit up to 16 mm \varnothing		E 60 C/U, EI 45 C/U
Unsheathed wires up to 24 mm \varnothing		E 60, EI 30
PVC conduit up to 16 mm \varnothing		EI 60 C/U, EI 60 C/C

A.3.2 Pipe penetration seal with 2x TYTAN B1 FIRE BOARD 1-S

Penetration Seal: CS (Continuous Sustained) insulated metallic pipes fitted at any position within the aperture (min. separation 40 mm from seal edges and 100 mm from other services), with 50 mm TYTAN B1 FIRE BOARD 1-S to both sides of the wall. TYTAN B1 FIRE WRAPS are required to be fitted around the pipe insulation. Maximum aperture size 2400 mm x 1200 mm.

Construction details:

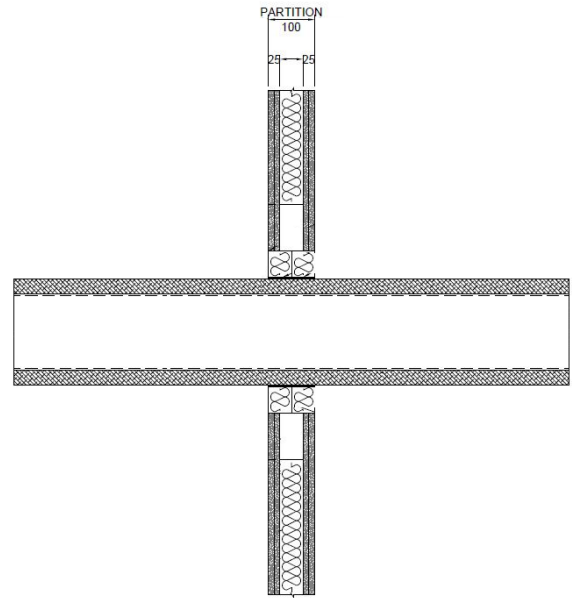
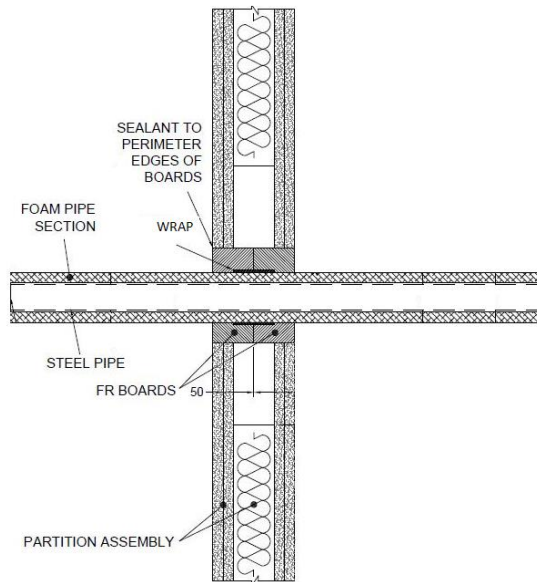

A.3.2.1 Two layer penetration seal with pipes

Services	Wrap	Insulation	Classification
Mild or stainless steel pipe			
40 mm diameter/1-14.2 mm wall	50 x 1.8 mm TYTAN B1 FIRE WRAP fitted centrally	13 mm Kaiflex ST insulation	EI 120 U/C, EI 120 U/U, EI 120 C/U, EI 120 C/C
40 mm diameter/1-14.2 mm wall*	2 off 50 x 3.6 mm TYTAN B1 FIRE WRAP, one fitted flush to each face of seal	13 - 32mm Kaiflex ST insulation	E 120 U/C, E 120 U/U, E 120 C/U, E 120 C/C, EI 60 U/C, EI 60 U/U, EI 60 C/U, EI 60 C/C
50 mm diameter/1.3-14.2 mm wall*			
60 mm diameter/1.6-14.2 mm wall*			
75 mm diameter/2-14.2 mm wall*			
90 mm diameter/2.4-14.2 mm wall*			
100 mm diameter/2.7-14.2 mm wall*			
115 mm diameter/3.1-14.2 mm wall*			
140 mm diameter/3.8-14.2 mm wall*			
165 mm diameter/ 4.5-14.2 mm wall*			

* Typical pipe diameters shown, see below graph for intermediate sizes

Pipe diameter vs Wall thickness

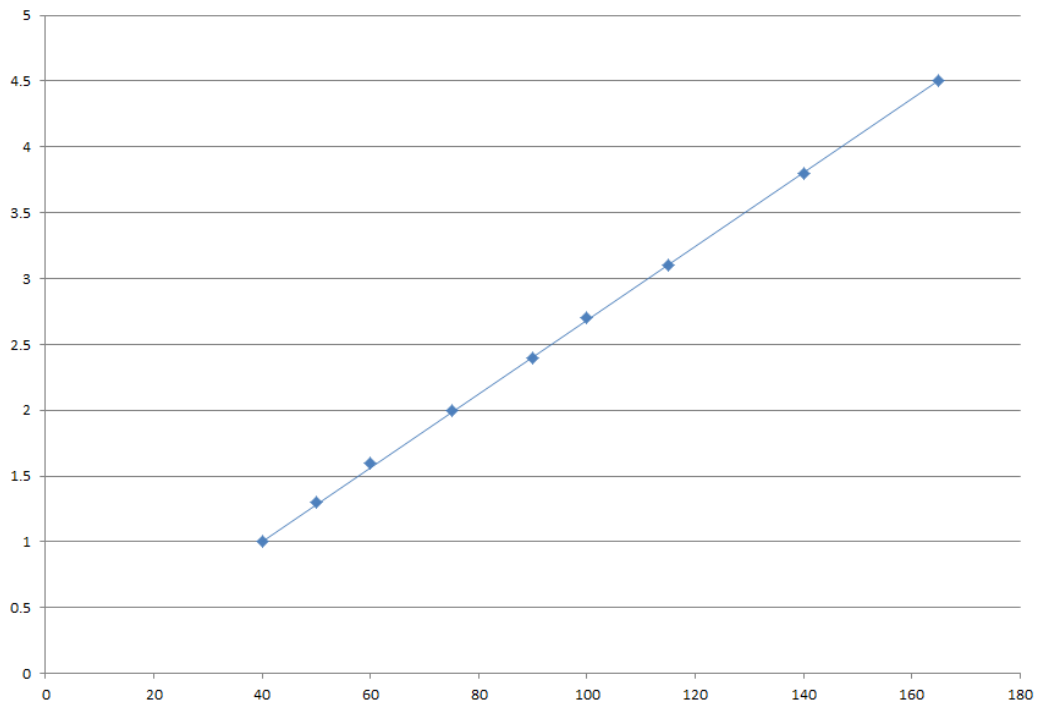

A.3.3 Pipe penetration seal with 2x TYTAN B1 FIRE BOARD 1-S

Penetration Seal: 500 mm (min.)* LI (Local Interrupted) or CI (Continuous Interrupted) insulated or uninsulated metallic and composite pipes (single) fitted at any position within the aperture (min. separation 40 mm from seal edges and 100 mm from other services), with 50 mm TYTAN B1 FIRE BOARD 1-S to both sides of the wall. Maximum aperture size 2400 mm x 1200 mm

Construction details:

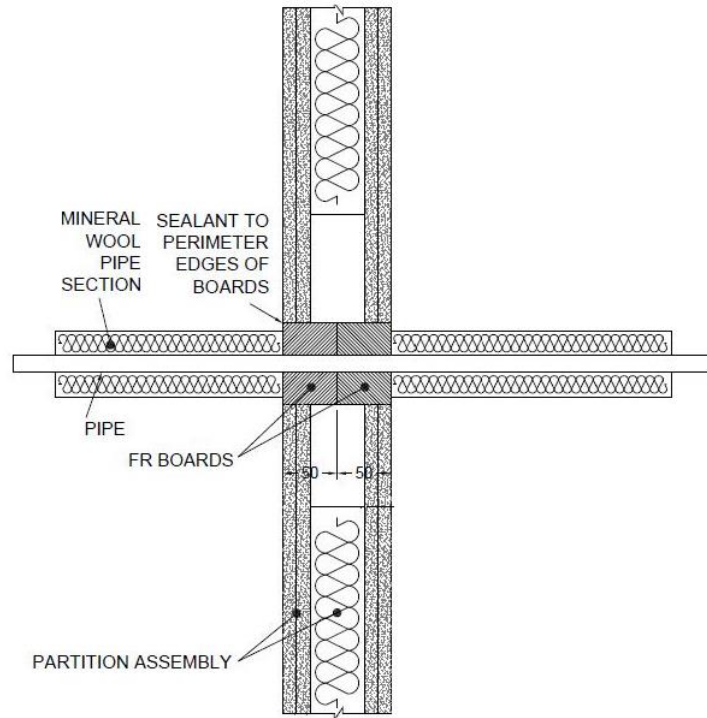

* Minimum 600 mm long insulation required for Alupex pipe.

A.3.3.1 Two layer penetration seal with pipes

Services	Insulation	Classification
Copper pipe up to 54 mm diameter/1-14.2 mm wall	20 mm stone wool 80 kg/m ³	EI 120 C/C
Alupex composite pipe 75 mm diameter/7.5 mm wall	600 mm length of 25 mm AES Fibre	EI 60 C/U
Mild or stainless steel pipe 114 mm diameter/11 mm wall	None	E 90 C/U, EI 20 C/U

Services	Insulation	Classification
Mild or stainless steel pipe		
40 mm diameter/1-14.2 mm wall	20 mm stone wool 80 kg/m ³	EI 120 C/U
40 mm diameter/1-14.2 mm wall*	30 mm stone wool 80 kg/m ³	E 120 C/U, EI 90 C/U
50 mm diameter/1.2-14.2 mm wall*		
60 mm diameter/1.4-14.2 mm wall*		
75 mm diameter/1.7-14.2 mm wall*		
90 mm diameter/2-14.2 mm wall*		
100 mm diameter/2.2-14.2 mm wall*		
115 mm diameter/2.5-14.2 mm wall*		
140 mm diameter/3-14.2 mm wall*		
165 mm diameter/3.5-14.2 mm wall*		
180 mm diameter/3.8-14.2 mm wall*		
200 mm diameter/4.2-14.2 mm wall*		
219 mm diameter/4.5-14.2 mm wall*		

* Typical pipe diameters shown, see below graph for intermediate sizes

Pipe diameter vs Wall thickness

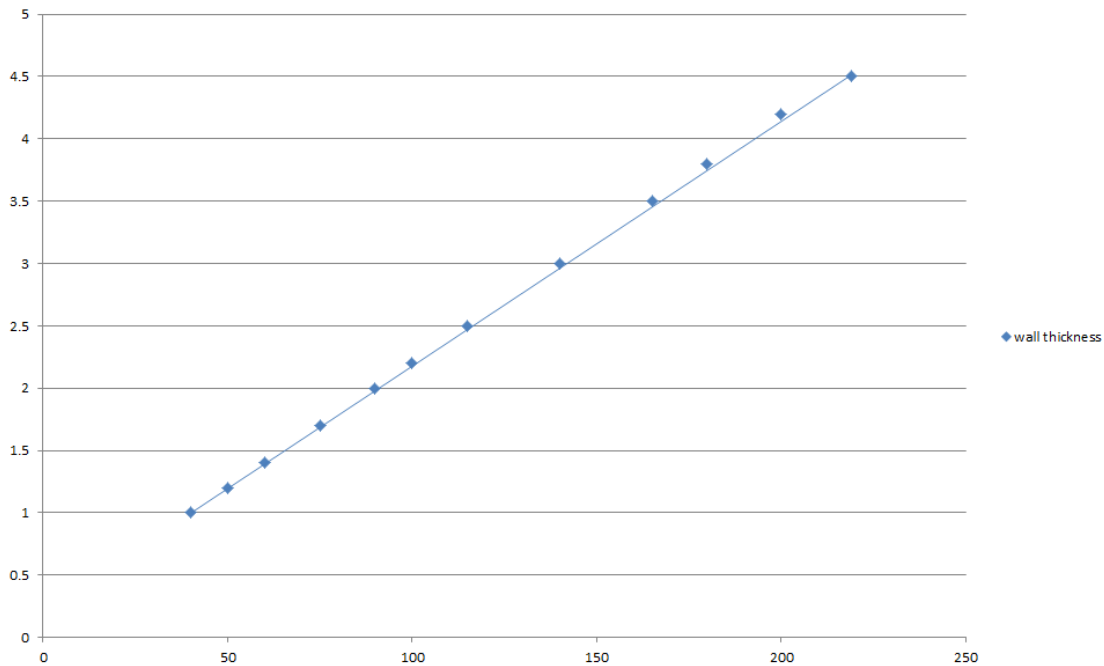

Services	Insulation (minimum)	Classification
Geberit Mepla MLC (PE-Xb/Aluminium/PE-HD) pipe*	20 mm stone wool 80 kg/m ³	EI 120 C/C
16 mm diameter/2.25 mm wall		EI 60 C/C
20 mm diameter/2.5 mm wall		
26 mm diameter/3 mm wall		
32 mm diameter/3 mm wall		
40 mm diameter/3.5 mm wall		
50 mm diameter/4 mm wall		
63 mm diameter/4.5 mm wall		
75 mm diameter/4.7 mm wall		

A.3.4 Pipe penetration seal with 2x TYTAN B1 FIRE BOARD 1-S

Penetration Seal: LS (Local Sustained) or CS (Continuous Sustained) insulated metallic and composite pipes (single) fitted at any position within the aperture (min. separation 40 mm from seal edges and 100 mm from other services), with 50 mm TYTAN B1 FIRE BOARD 1-S to both sides of the wall. TYTAN B1 FIRE WRAPS are required to be fitted around the pipe to both sides of the seal. Maximum aperture size 2400 mm x 1200 mm.

Construction details:

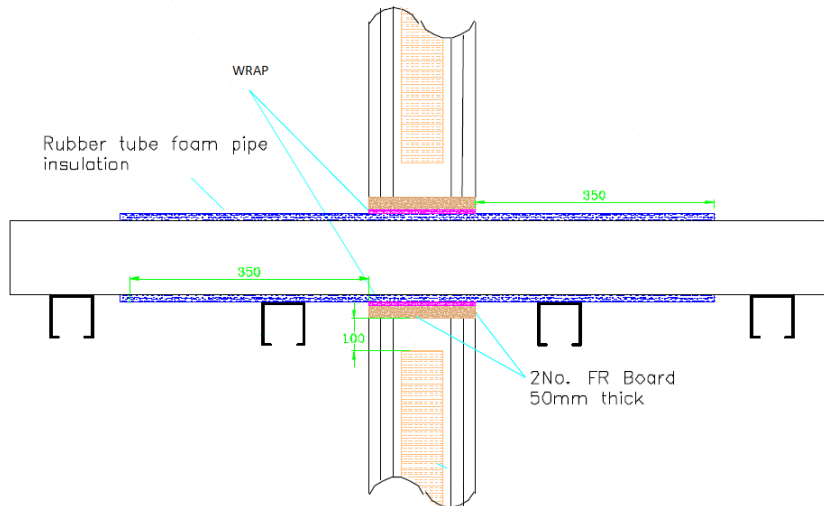

A.3.4.1 Two layer penetration seal with pipes

Services	Wrap	Insulation	Classification
Copper pipe			
12 mm diameter/1 mm wall	50 x 3.6 mm TYTAN B1 FIRE WRAP fitted to both sides of the seal	9 mm Kaiflex ST insulation	EI 120 C/C
12-54 mm diameter/1-1.2 mm wall		9-13 mm Kaiflex ST insulation	E 120 C/C, EI 90 C/C
12-54 mm diameter/1-1.2 mm wall		13-25 mm Kaiflex ST insulation	E 120 C/C, EI 60 C/C
Geberit Mepla MLC (PE-Xb/Aluminium/PE-HD pipe)*			
16 mm diameter/2.25 mm wall	50 x 3.6 mm TYTAN B1 FIRE WRAP fitted to both sides of the seal	9-25 mm Kaiflex ST insulation	EI 120 C/C
20 mm diameter/2.5 mm wall			
26 mm diameter/3 mm wall			
32 mm diameter/3 mm wall			
40 mm diameter/3.5 mm wall			
50 mm diameter/4 mm wall			
63 mm diameter/4.5 mm wall			
75 mm diameter/4.7 mm wall			

A.3.5 Plastic pipe penetration seal with 2x TYTAN B1 FIRE BOARD 1-S

Penetration Seal: Combustible pipes (single) fitted central within the aperture, with TYTAN B1 FIRE BOARD 1-S to both sides of the wall. TYTAN B1 FIRE WRAPS are required to be fitted around the pipe. Maximum aperture size 2400 mm x 1200 mm

Construction details:

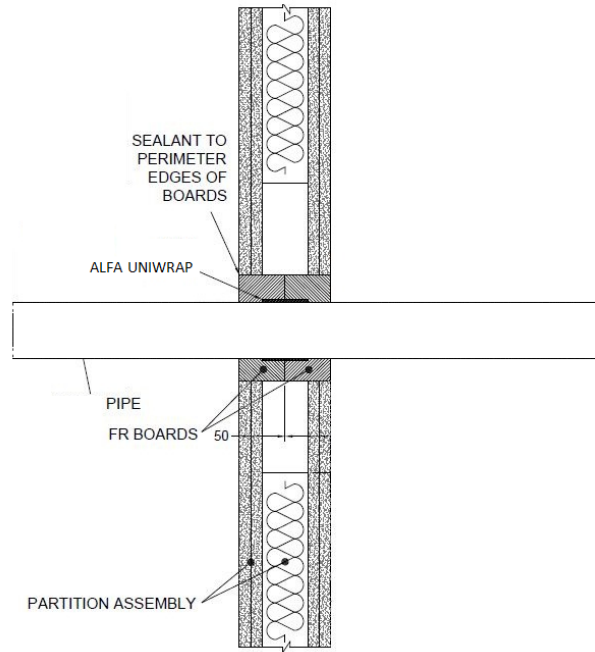

A.3.5.1 Two layer penetration seal with pipes

Services	Pipe Wrap	Classification
PVC-U pipe according to EN 1329-1, EN 1452-1 and EN 1453-1* 315 mm Ø/9.2 mm wall	TYTAN B1 FIRE WRAP 75 x 18 mm fitted centrally around the pipe	EI 45 C/C

* In Germany the pipes have additionally to comply with DIN 19531-10