

PSM-DI code 3021293

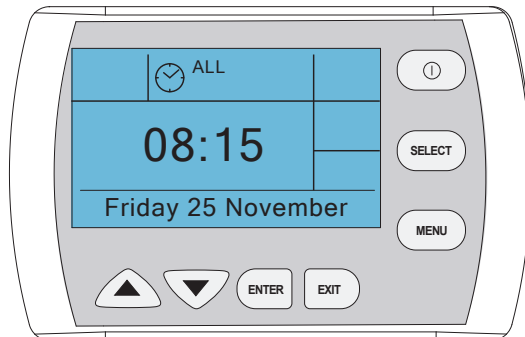

Multipurpose control panel for managing a fan coils network.

Installation and use instructions manual

Index:	Page:
-General description of the functions.....	3
-Quick description of keys and display.....	4
-Installation instructions.....	5
-Electrical connections.....	6
- Control series connection with the Cassette / Fancoil network.....	8
- Single unit addresses assignment.....	9
- I/O Input - Output Card.....	10
- Use of control.....	11
- Use of pushbutton panel.....	11
- Contrast adjustment.....	11
- Current day and time setting.....	12
- Network Analysis.....	12
- Switch all appliances on and off.....	12
- Appliances selection and set-up.....	13
- Types of main screen display.....	14
- General Menu.....	15
- Create weekly program.....	15
- Single weekly program.....	15
- Weekly program for groups.....	16
- Weekly program for I/O cards.....	17
- Weekly program activation.....	18
- Show weekly program.....	19
- Show Unit.....	19
- Energy Saving Mode.....	20
- Anti freezing Mode.....	20
- I/O Card Input.....	21
- Alarm Activated.....	21
- Parameters.....	22
- PSM-DI parameters table.....	22
- Priority Pump.....	23
- Total Reset.....	24
- Network Master/Slave.....	25

General description of the functions



Carefully read this installation and use manual before installing the PSM-DI control.

Up to 60 cassette/fancoil units can be installed in series, managing them with a single intelligent wall-mounted control, using the serial communication possibilities of the appliances. Set the operation conditions and modes of each individual connected appliance, the switch-on and off time bands for each day of the week and display the operation conditions of each individual appliance from the wall-mounted control.

Two or more intelligent wall-mounted controls are required if connecting more than 60 units. Each wall-mounted control will only manage the units connected to it.

More appliances, with a maximum of 60 units (RS 485 serial connection maximum development of 800 metres) can be managed with the PSM-DI panel, from a single control point.

The PSM-DI panel communicates with all connected appliances in serial, and can manage them all simultaneously or individually. All units can be simultaneously or individually recalled and the following functions carried out, by arranging an address of each individual cassette/fancoil:

- display the current operation mode, the ventilation speed, the set value;
- display the ambient temperature detected on the individual appliance;
- switch all appliances on and off simultaneously or individually;
- change the operation mode (cooling, heating, ventilation only, automatic change of functions);
- change the operation set;
- change the operation values and parameters of the fan speed (units equipped with electronic motor with Inverter only).

Each function can be sent to all connected appliances or to each individual appliance.

Different operation mode or set values can be set on each individual appliance.

Programmed appliance switch-on and off for each single day of the week can also be managed from the PSM-DI panel. Four switch-ons and four switch-offs can be set for each day. A different Temperature set that will be considered as Operation set for all connected appliances, can be set for each event.

If the wanted Temperature set is not entered for the individual event, it must be set during programming or for individual appliance or for entire appliance network.

Appliances without receiver or, in wanted situations, with receiver, can be connected within the network:

The first can only receive instructions from the PSM-DI wall-mounted panel. The second can receive information from both the wall-mounted panel (PSM-DI) and remote control. Use the remote control to force start-up of the individual appliance, if switch-on and off daily time programming has been set. The appliance will regain the settings set from the PSM-DI panel during execution of successive start-up program.



Note: set the configuration Dip Switches of each individual cassette/fancoil as illustrated in the remote control use manual, based on the wanted solutions.





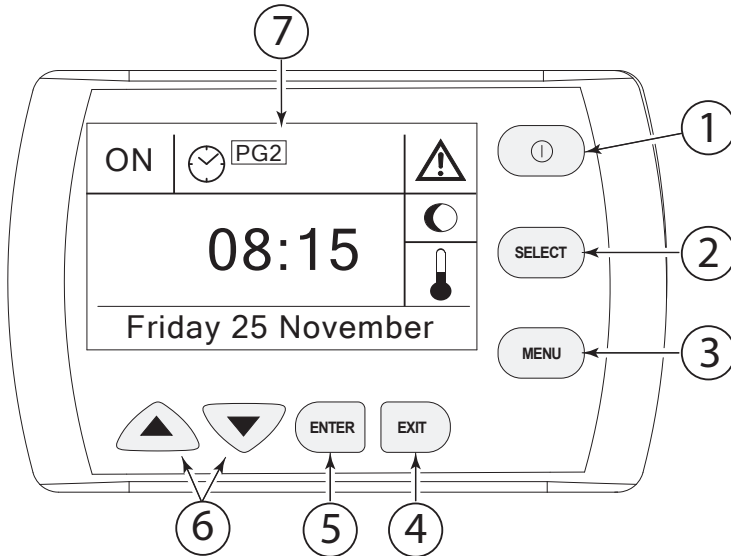

Note: the RS 485 network's overall length must not exceed 700/800 metres.

- Quick description of keys and display



1. System's main On-Off button.
2. Button to display or select the individual unit or all units or I/O cards (if present).
3. Setting menu access button.
4. Exit from menus button.
5. Functions confirmation button.
6. Time setting, temperature set and unit selection increase and decrease button.
7. Functions indication, unit selection and setting, programs status display, etc. display.

- Display symbols

-  Energy Saving Mode active
-  Anti freezing Mode active
-  Weekly program active
-  General Alarm
(check alarms in "Alarm activated" menu)

- Installation

Wall-mounted control assembly

The control can be mounted on wall or on 3 places rectangular (DIN503) or round (DIN501) fitted boxes



IMPORTANT! it is advised to install the control at **1.5 metres** from the floor.

Using a screwdriver, press the locking flaps on the upper part of the control to separate its front part from the rear plate (**Fig.1**).

After having disconnected the quick connection connector, carefully separate the two parts (**Fig.2**).

The Control is set-up for wall-mounting:

- Using the supplied plugs with screws (**Fig.3**).

Place the rear panel on the wall and mark the fastening points. Make the holes, place the plugs in the wall and lock the panel using the screws provided.

- Or, if available, on 1-2 DIN501 modules or 3 DIN503 modules junction box. (**Fig.4**).

Place the rear panel on the junction box and lock it using the screws provided.

Make the electrical connections as indicated in the wiring diagram on the following page.

Re-connect the quick connector;

Reassemble the front part of the control, firstly placing the two flaps in the lower part and then closing the control, by making the upper flaps click.

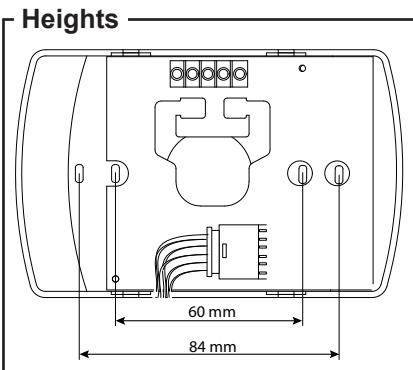
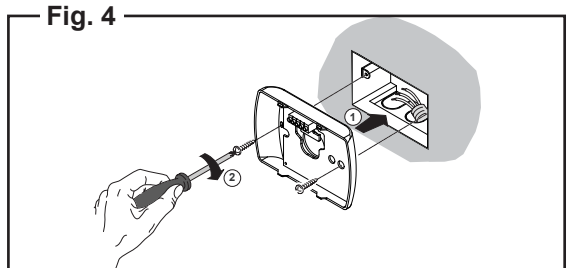
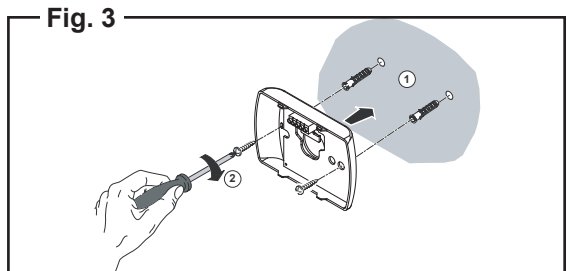
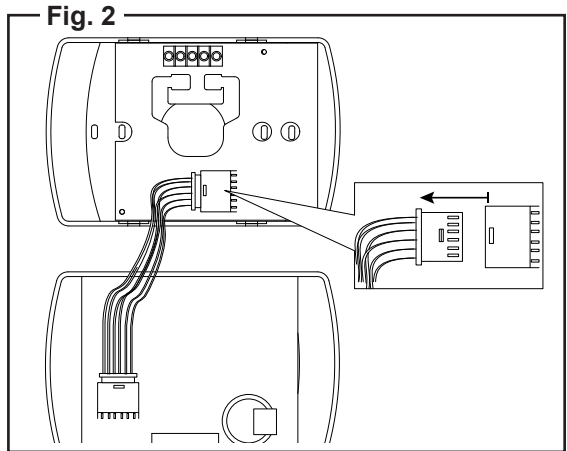
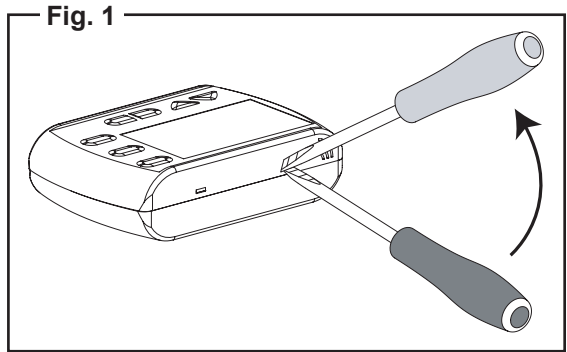

- Electrical Connections

Using the supplied power supply unit, power the PSM-DI control with 12 Volt power supply in DC (Fig.5).

Use 2 cables with 1.5 mm² section.

NOTE: The connection cable must not be longer than 20 metres.

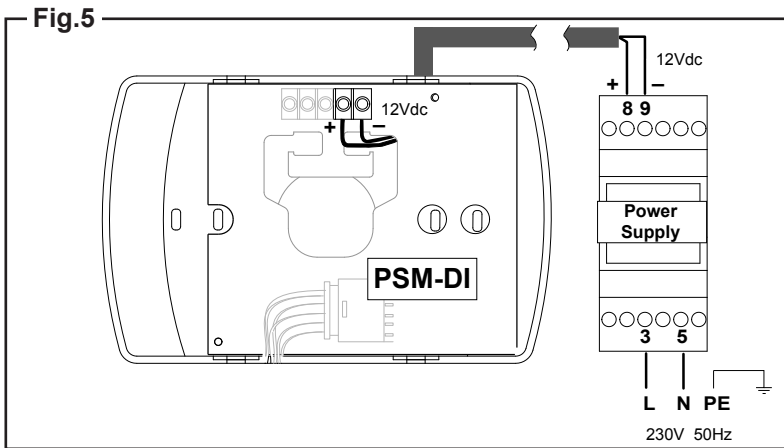

Then connect the wall-mounted control in series with the cassette/fancoil network.

Particular attention must be given in electrically connecting a cassette network using serial connection:

1. type of cable to be used: flexible RS-485, 1x2x24 AWG SFTP, 120 Ohm, Interface cable, PVC wrap, resistant to cold type **Belden 9841 cable**.
2. the network's overall length must not exceed 700/800 metres;
3. a maximum of 60 cassette can be connected.

Installation notes

- tighten the cables to a force of less than 12 kg. A greater force may fray the cables reducing the transmission properties;
- do not twist, knot, crush or fray the cables;
- do not lay the signal and power cables together;
- if the signal and power cables must cross, intersection must be at 90°;
- do not join cable sections. Use only one cable to connect the individual units together - do not excessively tighten the cables under the terminal connection clamps. Carefully strip the cable end. Do not crush the cable at cable glands or safety supports;
- always respect the colours position in correspondence of the connection start and end points - visually and physically check the cables are in good condition and correctly positioned, once wiring is completed;
- install the cables and units minimising the possibility of accidental contacts with other power cables or potentially dangerous cables, such as the lighting system cables;
- do not lay the 12 volt power supply and communication cables near power rods, lights, antennae, transformers or hot water or steam pipes;
- never position the communication cables in any conduits, pipes, junction boxes or other container together with the power cables or lighting system cables;
- always adequately separate communication cables from all other electrical cables;
- keep the communication cables and the units, at least 2 metres away from units with heavy inductive loads (distribution panels, motors, generators for lighting systems).

We recommend using a Belden 9841 cable for the RS 485 serial line

RS-485, 1x2x24 AWG SFTP, 120 Ohm, Interface cable, PVC wrap, resistant to cold

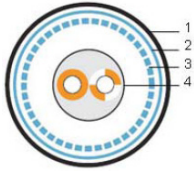

- 1 - External sheath
- 2 - Sheet shielding
- 3 - Mesh shielding
- 4 - Solid twisted pair

Connection diagram

Connect all cascade appliances with a chain connection



Instrumental cable for RS-485 applications consists of a twisted pair (24 AWG), wrapped in aluminium sheet shielding and twisting. The cable is wrapped in extremely resistant PVC wrap. The cable complies with Standard UL 1581 VW-1.

Conductive material: multicore, soft tinned copper conductor.

Cores insulation: foamed polyolefin.

Shielding: aluminium sheet (metal side on external part) and copper twisted mesh, density of sheet shielding - 100%, twisting - 90%, 0.127 mm.

External sheath: extremely resistant PVC.

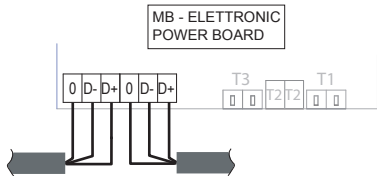
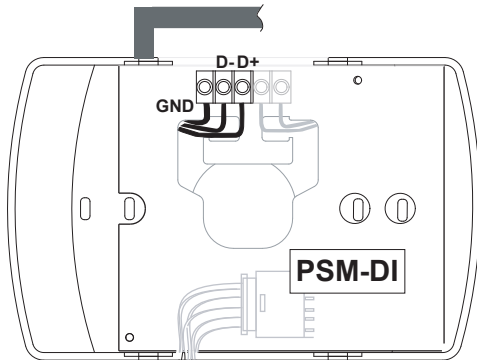

**RESPECT THE
CORRECT CONNECTION
SEQUENCE**

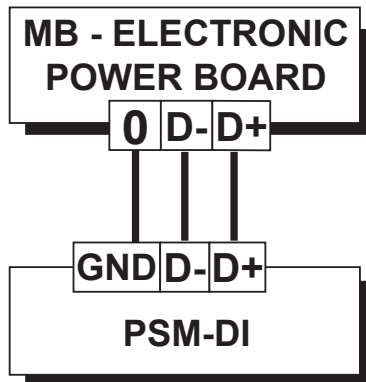

- PSM-DI Control series connections with the Cassette / Fancoil network

It is important to define the start and end of a serial network, closing Jumper MC2 on the first and last connected unit. Illustrated below are the possible engineering situations:

Configuration 1: PSM-DI Control connection to the first network unit layout.

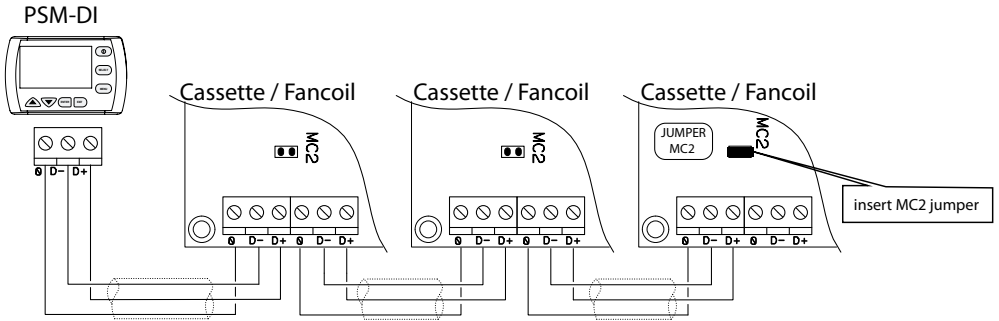

Configuration 2: PSM-DI Control connection to the last unit of a network layout.

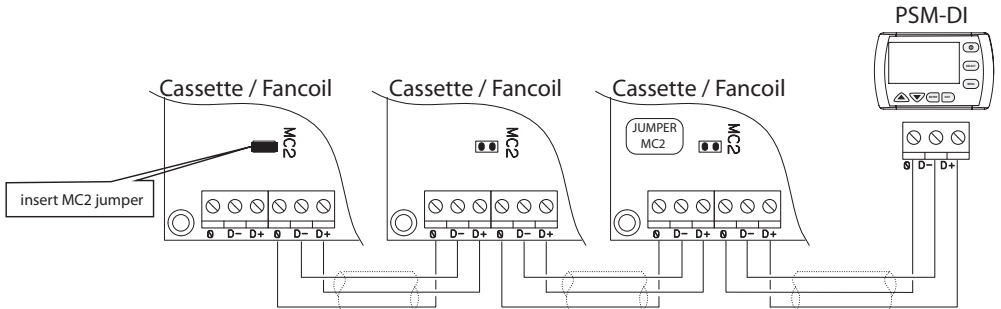

- Single unit addresses assignment

The electronic power board of each individual equipment must be configured with a numerical address for recognition by the PSM-DI control panel. Do not use the same address for different equipment within each individual network. This would cause an error signal during data transmission. Configure the Dip Switches **Address** to assign the relative number to each appliance.

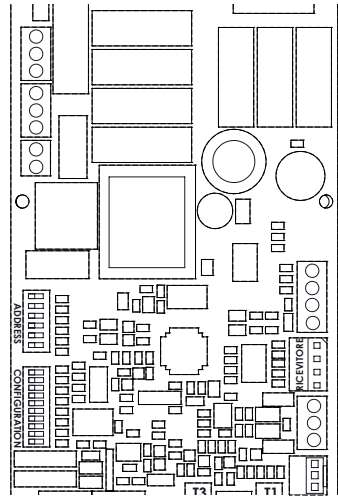

Set the Dip Switches as follows, based on the table below:

- equipment No. 1: Dip 1 ON all others OFF
- equipment No. 2: Dip 2 ON all others OFF
- equipment No. 3: Dip 1+2 in ON all others OFF
- equipment No. 4: Dip 3 in ON all others OFF
- equipment No. 5: Dip 1+3 in ON all others OFF
- etc., following the table

**IMPORTANT!: The physical address of I/O card must always be 61.
Do not use this address for the equipment.**

Indirizzo/ Address	Dip Switches ON	Indirizzo/ Address	Dip Switches ON	Indirizzo/ Address	Dip Switches ON	Indirizzo/ Address	Dip Switches ON
1	1	21	1+3+5	41	1+4+6	61	1+3+4+5+6
2	2	22	2+3+5	42	2+4+6		
3	1+2	23	1+2+3+5	43	1+2+4+6		
4	3	24	4+5	44	3+4+6		
5	1+3	25	1+4+5	45	1+3+4+6		
6	2+3	26	2+4+5	46	2+3+4+6		
7	1+2+3	27	1+2+4+5	47	1+2+3+4+6		
8	4	28	3+4+5	48	5+6		
9	1+4	29	1+3+4+5	49	1+5+6		
10	2+4	30	2+3+4+5	50	2+5+6		
11	1+2+4	31	1+2+3+4+5	51	1+2+5+6		
12	3+4	32	6	52	3+5+6		
13	1+3+4	33	1+6	53	1+3+5+6		
14	2+3+4	34	2+6	54	2+3+5+6		
15	1+2+3+4	35	1+2+6	55	1+2+3+5+6		
16	5	36	3+6	56	4+5+6		
17	1+5	37	1+3+6	57	1+4+5+6		
18	2+5	38	2+3+6	58	2+4+5+6		
19	1+2+5	39	1+2+3+6	59	1+2+4+5+6		
20	3+5	40	4+6	60	3+4+5+6		

- I/O Input - Output Card

The I/O card is an electronic power board equipped with 8 voltage-free contact inputs for displaying the different devices status and 8 relay outputs with NO contact type SP-ST (2A AC3) for controlling remote electric utilities switch-on or off, for example:

- Pumps and Valves
- Chiller
- Air shutter
- Lights, Outdoor lights
- Extractors
- Fans

Use the I/O card combined with the Sabianet supervisor program or the PSM-DI wall-mounted control.

Only one I/O card can be connected in the same network.

Use the Sabianet program or the PSM-DI control is possible to manage the opening/closing of contacts of each individual relay (OUTPUT) identified by output number from 1 to 8, checking the status at any moment.

Also, the output relay status can be combined to a weekly program.

Similarly, the status of the inputs contacts can be displayed.

IMPORTANT!: Firstly, using the 6 Dip connector, define the physical address.

The physical address of I/O card must always be 61.

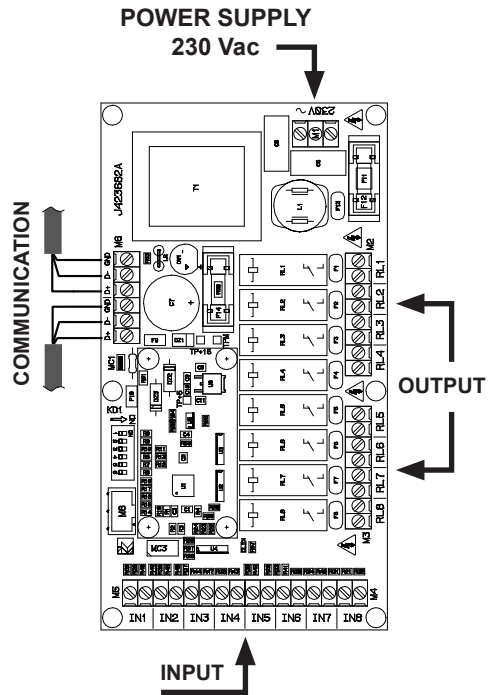

INPUT

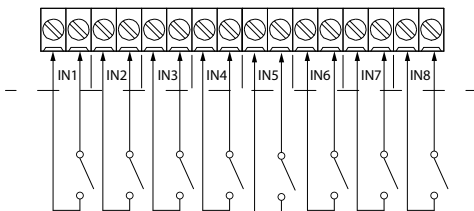

OUTPUT

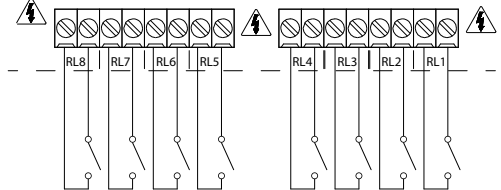

CLOSED

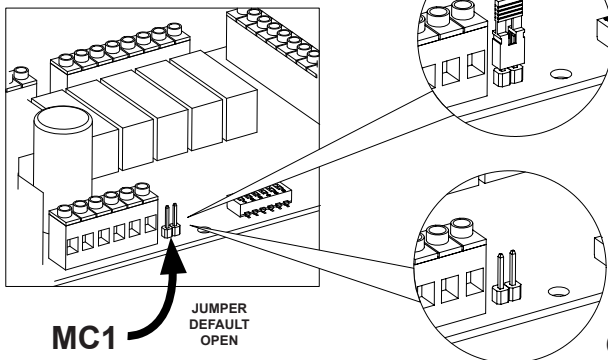

Serial connection - network end JUMPER.

The network must be closed on the last card in case of RS485 connection (PSM-DI or Sabianet). Closure is through **JUMPER MC1** if the last card is the I/O card.

OPEN

- Use of PSM-DI control

Use of pushbutton panel:



ENTER BUTTON: select and confirm button.



UP and DOWN BUTTONS: parameters increase and decrease.
Scrolling of parameters and of functions.



EXIT BUTTON: return to previous screen button.

- Language setting:

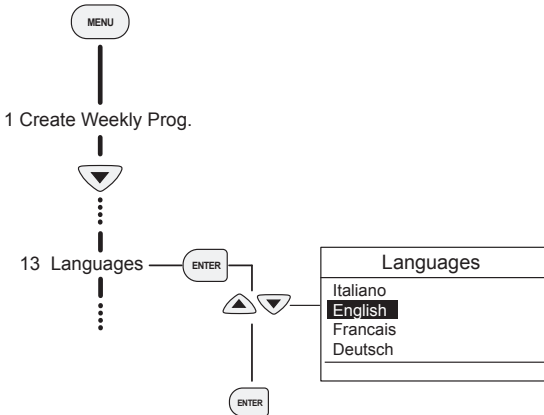

Selects the language in which the messages will be displayed.

Once selected, the menus, the messages, the parameters will be displayed in the wanted language.

- Contrast adjustment:

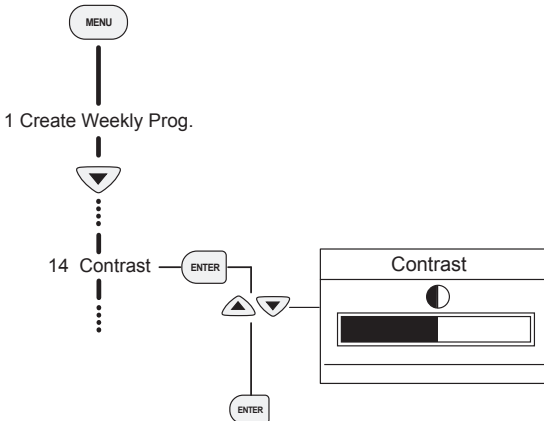

Adjusts the display's brightness intensity.

- Current Day and Time setting:

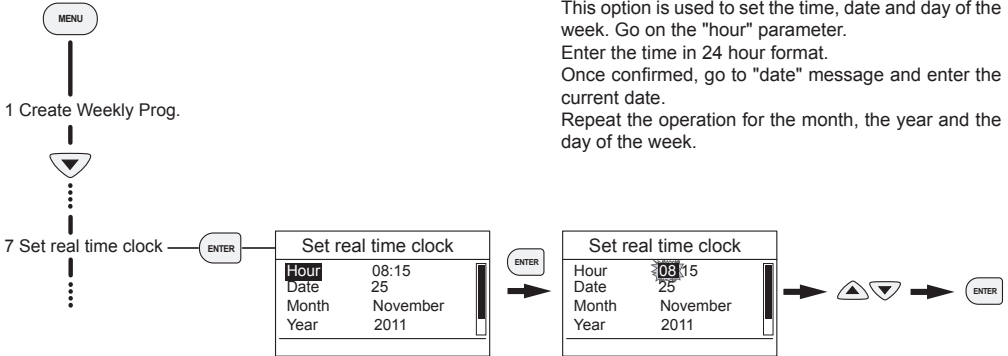

This option is used to set the time, date and day of the week. Go on the "hour" parameter. Enter the time in 24 hour format. Once confirmed, go to "date" message and enter the current date. Repeat the operation for the month, the year and the day of the week.

Network Analysis:

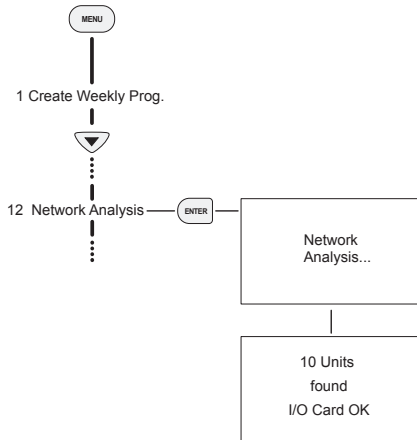

Analyse the network to check its progress, once primary settings have been executed. Follow the indications in the figure at the side step-by-step.

Once done, the display will show the found units; Press **EXIT** to go back to the main screen.

Simultaneously switch all appliances on and off:

ON STATUS

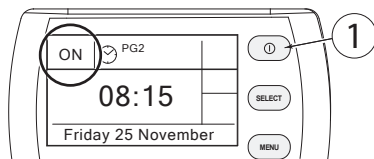

OFF STATUS

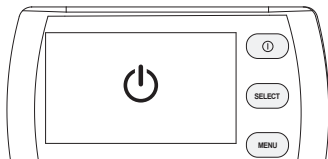

The PSM-DI control and all equipment can be simultaneously switched on and off with a single button:

- ON = Switches control and all units on; sets-up control for managing all its functions, including the weekly program.

- OF = Switches control and all machines off; also deactivates the control in all its functions, including the weekly program, except the anti freezing function (if activated).

Keep **⏻** pressed for 5 seconds until the symbol **⏻** appears on display.

To go back to ON, press **⏻** for 5 seconds again.

Equipment selection and set-up

Set an individual or all equipment simultaneously by using the button **SELECT**. The current operation status will appear on display once the unit to be set is selected.

Now change the operation parameters:

- Equipment status (On or OFF).
- Wanted set (range: min 10°C - max 30°C).
- Operation mode: Winter - Summer - Ventilation or Automatic (only for 4 pipe systems).
- Ventilation speed: Min = Minimum - Med = Medium - Max = Maximum - Auto = Automatic.

Follow the procedure below to correctly set the equipment parameters:

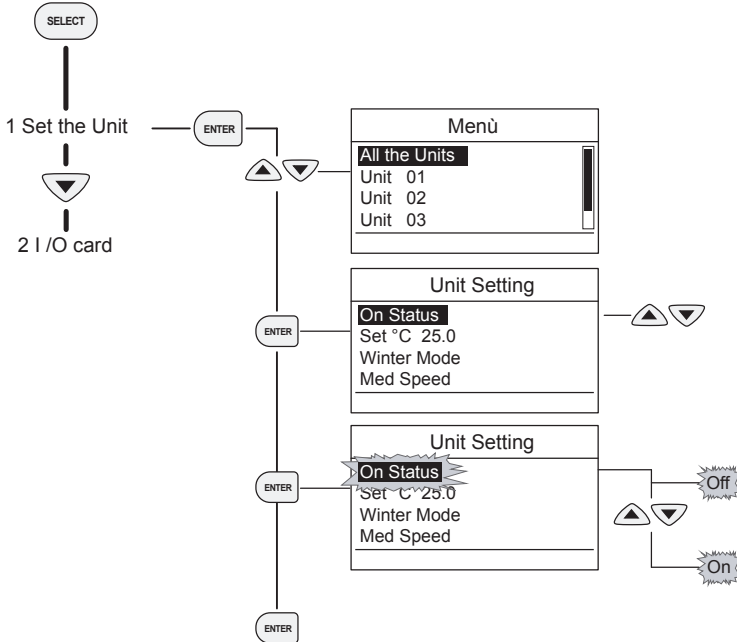

Press **EXIT** to go back to the main screen once the parameters have been changed.

Types of main screen display.

The control has 3 different main screen display:

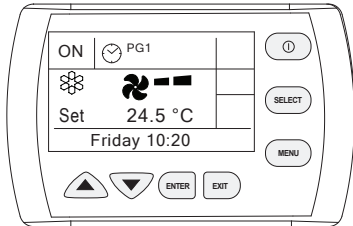

1) Univocal equipment setting: the display shows the speed, the set and the operation mode data, if all equipment has been set with the same parameters.

2) Different equipment setting: the display cannot show data for each individual equipment if this does not have the same setting or weekly programs activated, but will only propose the time and date. Refer to the "Show Unit" paragraph to display the system's and individual machines' flow.

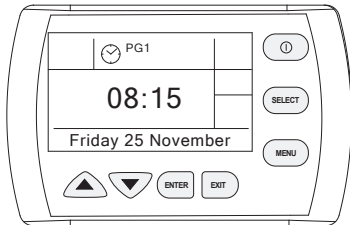
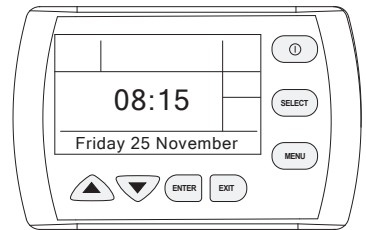

3) Equipment setting with weekly programs: The control's display shows the time and date if one or more weekly programs are active, and the symbol ⌚ with the name of the activated weekly program in the central part (PG1 or PG2 or ALL). The frame around the weekly program's name indicates whether the program is running.

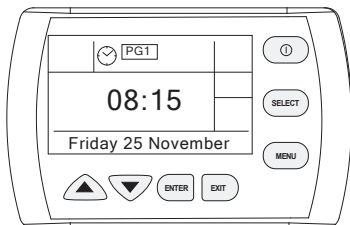

General Menu

From the general menu:

- Create, display and manage the weekly programs.
- Activate special functions which: Energy saving mode, Anti freezing mode.
- Display the equipment status.
- Set the equipment parameters.
- Display the activated alarms.

- Weekly program creation

A weekly work program (7 days) can be set from the control.

The Program can be set for all equipment or for a maximum of two groups of equipment.

Four switch-ons and four switch-offs can be set for each day of the week.

The system can be switched on and off by each daily work program 4 times for every day of the week; e.g. it is possible to set appliances operation period that goes from 8 a.m. to 12 p.m. and from 2 p.m. to 6 p.m.; or a single program from 8 a.m. to 6 p.m..

A different temperature set can be set for each operation period. For example, set the appliance to operate from 8 a.m. to 4 p.m. with a set value of 20°C, and from 4.01 p.m. to 6 p.m. with a set value of 16°C.

Single weekly program for all equipment

All equipment connected to the control can be managed using this program.

Press the menu button and access **2 Create Weekly Prog.**; Select **1 All the Units**;

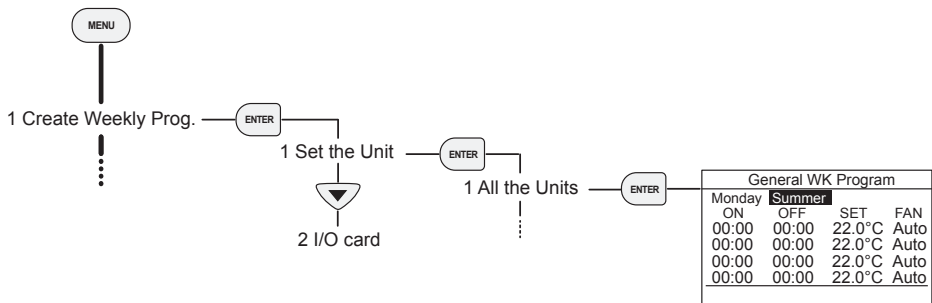

General WK Program			
Monday	Summer		
ON	OFF	SET	FAN
00:00	00:00	22.0°C	Auto
00:00	00:00	22.0°C	Auto
00:00	00:00	22.0°C	Auto
00:00	00:00	22.0°C	Auto

Press **ENTER** to confirm the parameter to be changed.

Press **▲▼** to set the wanted parameter.

Confirm with button **ENTER**.

Automatically goes on to successive parameter setting.

Use buttons **▲▼** to scroll the parameters.

Proceed as above to execute the other settings.

Once data relating to the first day of the week has been entered, go to the day of the week using buttons **▲▼** and press **ENTER** to go on to successive day.

General WK Program			
Next day			
ON	OFF	SET	FAN
00:00	00:00	22.0°C	Auto
00:00	00:00	22.0°C	Auto
00:00	00:00	22.0°C	Auto
00:00	00:00	22.0°C	Auto

General WK Program
Tuesday Summer
New
Copy
Previous day
Next day

Create a new program (**New**) or copy that of previous day (**Copy**). Press **ENTER** to confirm the choice.

Set all days of the week; then press **EXIT**, save the weekly program and go back to main screen.

Weekly program for groups of equipment

All equipment connected to the control can be managed using this program, dividing it into one or maximum two groups. Firstly create the equipment groups:
 Press the menu button and access **2 Create Weekly Prog.**; Select **2 Create Group 1**: select the appliances to be grouped in group 1. If required, repeat the operation to create and associate the appliances for group 2.

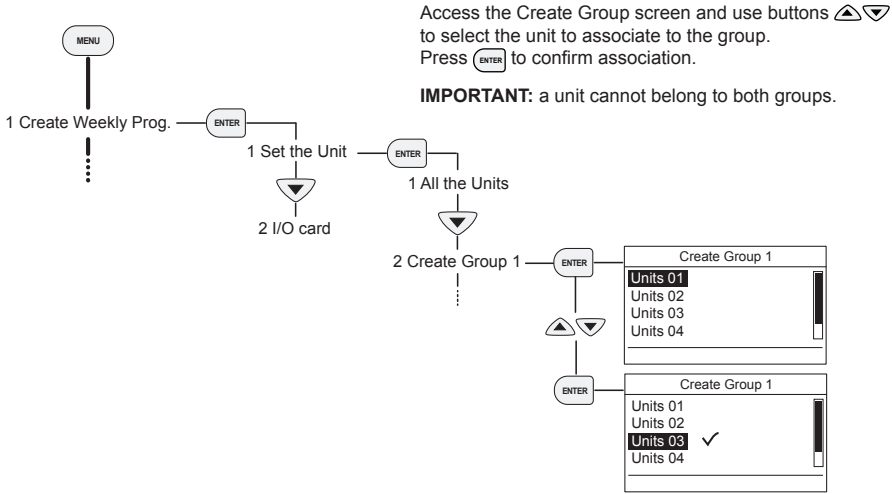

Access the Create Group screen and use buttons to select the unit to associate to the group. Press to confirm association.

IMPORTANT: a unit cannot belong to both groups.

Now the groups have been created, create the weekly program dedicated to it. Press the menu button and access **2 Create Weekly Prog.**; Select **3 WK Program Group 1**:

General WK Program			
Monday	Summer		
ON	OFF	SET	FAN
00:00	00:00	22.0°C	Auto
00:00	00:00	22.0°C	Auto
00:00	00:00	22.0°C	Auto
00:00	00:00	22.0°C	Auto

Press to confirm the parameter to be changed.
 Press to set the wanted parameter.
 Confirm with button .
 Automatically goes on to successive parameter setting.
 Use buttons to scroll the parameters.
 Proceed as above to execute the other settings.

Once data relating to the first day of the week has been entered, go to the day of the week using buttons and press to go on to successive day.

General WK Program			
Next day			
ON	OFF	SET	FAN
00:00	00:00	22.0°C	Auto
00:00	00:00	22.0°C	Auto
00:00	00:00	22.0°C	Auto
00:00	00:00	22.0°C	Auto

General WK Program
Tuesday Summer
New
Copy
Previous day
Next day

Create a new program (**New**) or copy that of previous day (**Copy**). Press to confirm the choice.

Set all days of the week; then press , save the weekly program and go back to main screen.

Weekly program for I/O cards

A weekly work program (7 days) can be set from the control for any I/O card present in the system's network.

A single weekly program can be created for all output relay or create a program for each individual output relay. (I/O card max 8 outputs).

Press the menu button and access **2 Create Weekly Prog.**; Select **2 I/O card**;

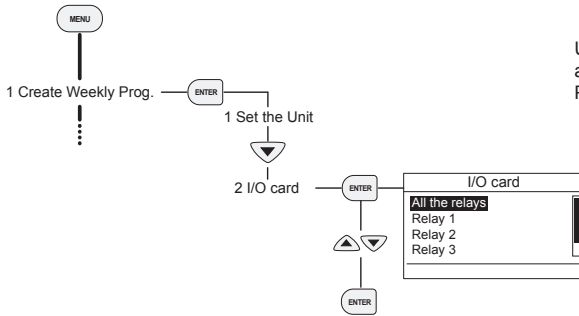

Use buttons ▲▼ to select the relay for program association.

Press ENTER to confirm choice.

Press ENTER to confirm the parameter to be changed.

Press ▲▼ to set the wanted parameter.

Confirm with button ENTER.

Automatically goes on to successive parameter setting.

Use buttons ▲▼ to scroll the parameters.

Relays General WK Prog.	
Monday	
ON	OFF
00:00	00:00
00:00	00:00
00:00	00:00
00:00	00:00

Once data relating to the first day of the week has been entered, go to the day of the week using buttons ▲▼ and press ENTER to go on to successive day.

Relays General WK Prog.	
Next day	
ON	OFF
08:00	18:00
00:00	00:00
00:00	00:00
00:00	00:00

Create a new program (New) or copy that of previous day (Copy).

Relays General WK Prog.
Tuesday
New
Copy
Previous day
Next day

Press EXIT to save the weekly program and go back to the main screen, press ENTER to confirm the program.

NOTE: The control does not enable creating the dedicated weekly program if I/O cards are not present.

- Weekly program activation

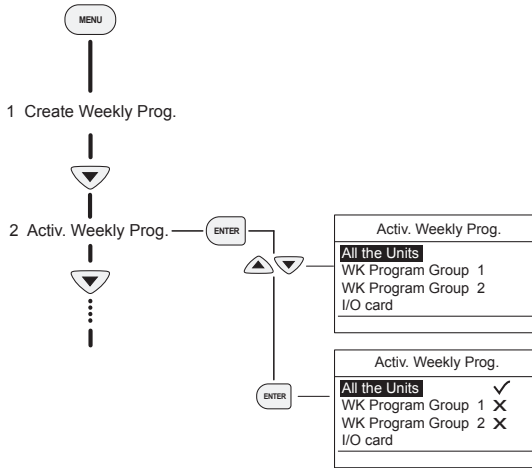

By default the weekly programs are not active once created. Use the "Activ. Weekly Prog." screen in the menu to activate them.

Use buttons ▲▼ to select the program to be activated.
Press ENTER to confirm activation.

IMPORTANT: ✓ Program active
✗ Program not active

or

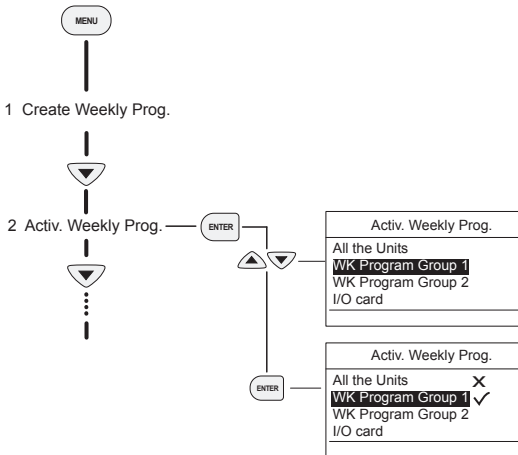

Note: The single weekly program or weekly programs for groups can be activated; both programs cannot be simultaneously activated.

Note: weekly program activation for I/O cards is not linked to the activation of the other weekly programs.

- Show weekly program

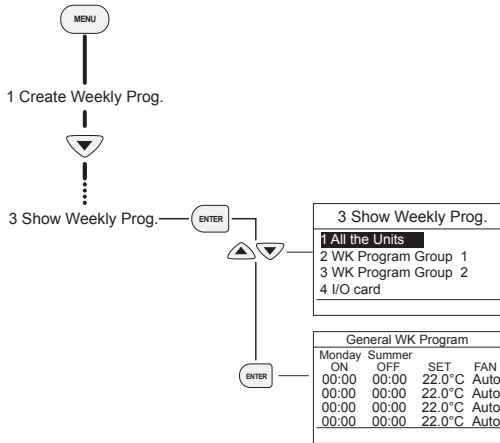

This option is used to display the previously created weekly programs.

Access the menu and select "Show Weekly Prog." Choose the weekly program to be displayed using buttons ▲▼ and press **ENTER** to confirm.

Use buttons ▲▼ to scroll the days of the week.

- Show Unit

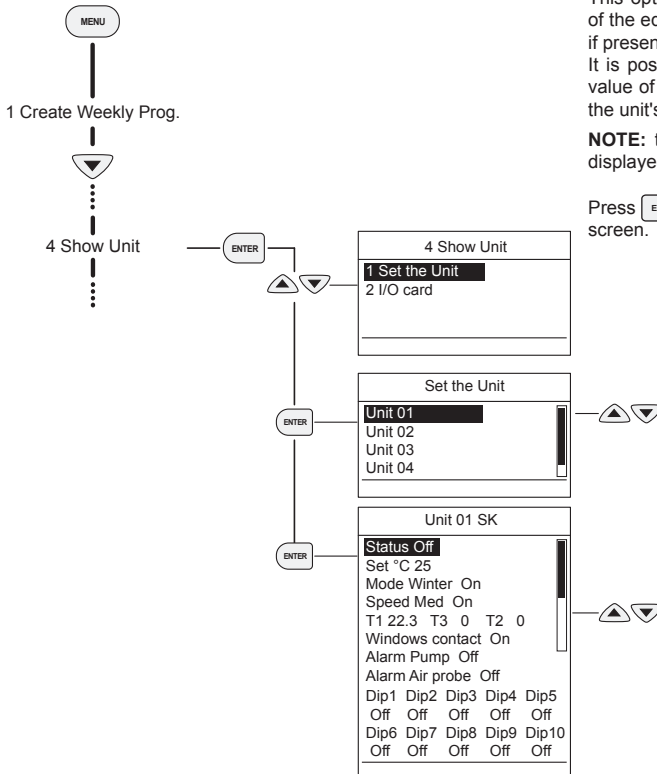

This option is used to display the current status of the equipment in the network and the I/O card, if present.

It is possible to display: status, set, mode, read value of air and water probes, active alarms and the unit's dip switches setting.

NOTE: the output voltage from inverter can be displayed only for the ECM versions.

Press **EXIT** to go back to previous screen.

- Energy saving mode (Changeable Parameters (P_p))

The set temperature set is forcedly changed by enabling this option:

- winter cycle: Energy saving set = Set - 5°C
- summer cycle: Energy saving set = Set +5°C

The display shows a screen for choosing the number of days the function must remain active (including day of activation), once the function is enabled. Set the number of wanted days using the buttons ▲▼ and press **ENTER** to confirm.

The function remains active only for the set number of days.

Press **EXIT** to go back to previous screen.

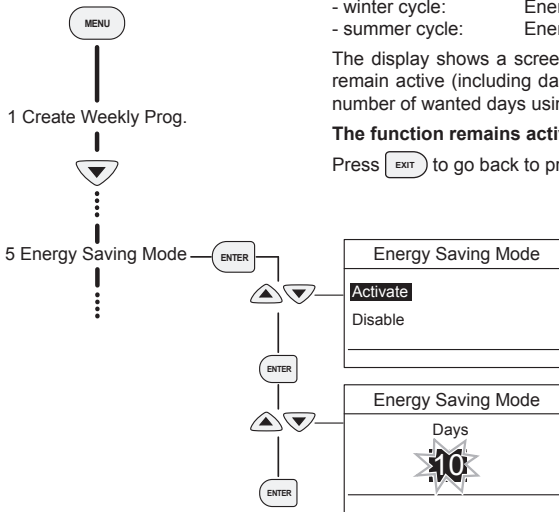

Note: the symbol ☾ is displayed on the main screen to indicate the energy saving function is active.

Activation is univocal for all network equipment.

- Anti freezing mode (Changeable Parameters (P_p))

If the air temperature detected by the individual appliance is below +5°C, by enabling this option the fan is activated at low speed with opening of the hot water valve. With ambient air above 8°C the anti freezing mode ends.

T ≤ +5°C anti freezing mode activates T > +8°C anti freezing mode intervention ends.

IMPORTANT: when control is placed at OFF, but with system electrically powered, this function is run.

Activation is univocal for all network equipment.

The symbol 🌡️ will appear on the main screen once activated.

Press **EXIT** to go back to previous screen.

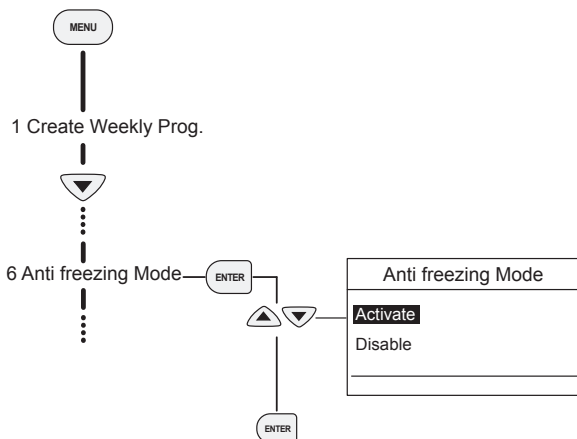

- I/O Card Input

Associate the digital inputs of the I/O card to any alarms with this option.

These alarms are based on the input contact status: OFF = regular operation (Contact CLOSED)

ON = ALARM (Contact OPEN)

Press **menu** and access **9 I/O Card Input**; to activate the inputs alarm signal. Once the function is accessed, the display will show:

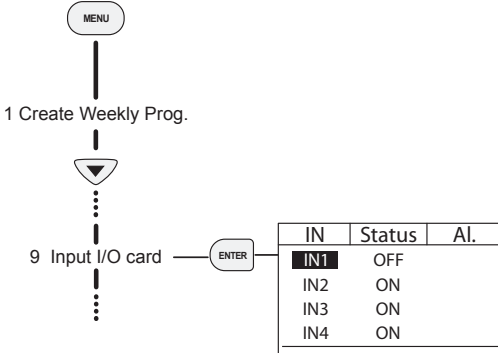

Use buttons to select the input for alarm association. Press to confirm choice.

The symbol will appear next to the chosen input number:

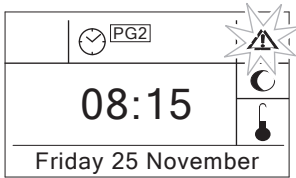

IN	Status	Al.
IN1	OFF	

By enabling the alarms, the symbol will flash on the control's display main screen when the IN input changes from OFF to ON.

Use the "Alarm Activated" function to display which IN input is in alarm.

- Alarm Activated

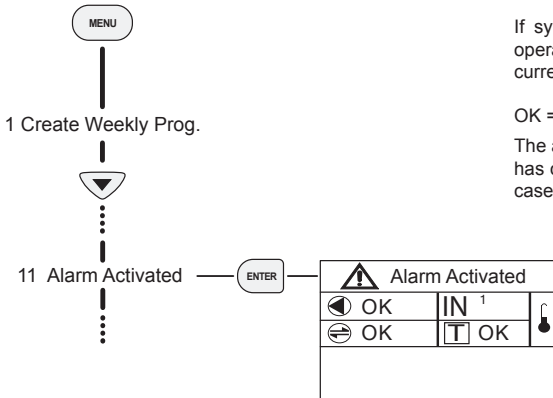

If symbol appears on the display during normal operation, use this option to display which alarm(s) are currently present in the network.

OK = alarm not active

The address number of the appliance where the problem has occurred (see image) appears next to the symbol in case of alarm.

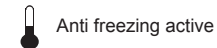
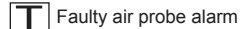

Press to go back to previous screen.

- Parameters

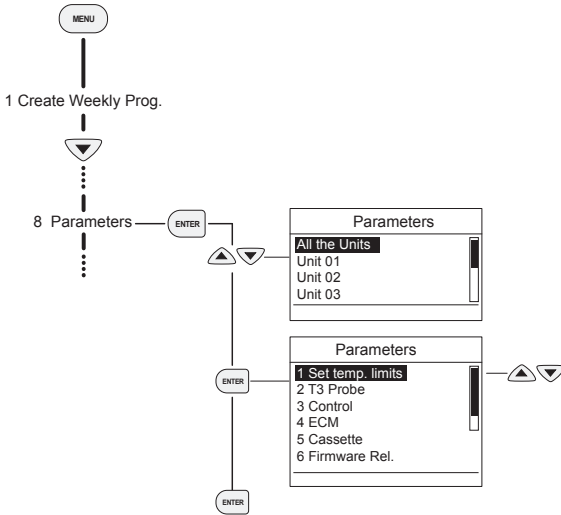

This menu allows modifying the operation parameters of the appliances, electronic motor, of the +/- 3 version and many other parameters (pump cycle, etc..).

It is also possible to check which firmware is present on the selected equipment.

Press Menu and choose the parameters function using buttons \blacktriangle \blacktriangledown and confirm using button ENTER .

Press buttons \blacktriangle \blacktriangledown to choose the parameter to be changed and confirm with button ENTER .

The value can be modified using buttons \blacktriangle \blacktriangledown , once the parameter is selected. Confirm with button ENTER .

Below is a table concerning the changeable parameters.

PSM-DI CHANGEABLE PARAMETERS (P_p)

1 SET TEMP. LIMITS	default	Range
Summer max value	30	10 ÷ 30°C
Summer min value	10	10 ÷ 30°C
Winter max value	30	10 ÷ 30°C
Winter min value	10	10 ÷ 30°C

2 T3 PROBE	default	Range
T3 probe hysteresis	4 °C	2 ÷ 6 °C
Summer T3 probe (Fan ON in cooling mode)	< 22 °C	< 10 ÷ 25 °C
Winter T3 probe (Fan ON in heating mode)	> 36 °C	> 30 ÷ 40 °C

3 CONTROL	default	Range
Therm. Hysteresis	0.7°C	0.5 ÷ 2.0 °C
Anti freezing Mode	5	4 ÷ 8 °C
Energy Saving Mode	5	3 ÷ 8 °C
Dead zone range (dead zone field setting only for 4 Pipe systems)	2°C	1 ÷ 6 °C

5 ECM	default	Range
Min Inverter Volt	1 V	1 ÷ 6
Med Inverter Volt	5 V	3 ÷ 8
Max Inverter Volt	10 V	6 ÷ 10
Heat Min Volt. Value (Minimum automatic speed in heating)	1 V	1 ÷ 6
Heat Max Volt. Value (Maximum automatic speed in heating)	10 V	5 ÷ 10
Cold Min Volt. Value (Minimum automatic speed in cooling)	1 V	1 ÷ 6
Cold Max Volt. Value (Maximum automatic speed in cooling)	10 V	5 ÷ 10
Heat Prop. Band (proportional band in heating setting)	3.5 °C	2,0 ÷ 6,0
Cold Prop. Band (proportional band in cooling setting)	3.5 °C	2,0 ÷ 6,0

4 CASSETTE	default	Range
Pump Delay time (pump post-circulation T. ON)	150 sec.	0 ÷ 300 sec
Summer Pump on t. (post-ventilation time)	3 min.	0 ÷ 5 min.
T1 Compensation (air probe compensation in winter cycle)	1.5 °C	0.5 ÷ 2.0 °C
Summer T. OFF	60 min.	30 ÷ 90 min.

- Priority Pump:

The I/O card can be used to control the switching on and off of various electric devices, among which water pumps for heating and cooling. The relays of the I/O card can be managed individually or through the Weekly Program. The PSM-DI command also allows you to manage the water pumps relays automatically depending on the state of the fan coils connected.

This feature is enabled by selecting the "Priority Pump" by the PSM-DI menu..

With the option "Priority Pump" it is possible to activate the water circulation only at the request of the fan coil thermostats switching on the pumps only when actually needed and improving the power consumption of the system.

Once you have activated the option "Priority Pump" the PSM-DI controller operates on two relays, RL1 and RL2 SIOS card, as follows:

- RL1 - manages the circulation pump hot water - winter mode
- RL2 - manages the circulation pump cold water - summer mode

When enabled the "Priority Pump" option, it is no longer possible to create a Weekly Program for the two relays RL1 and RL2.

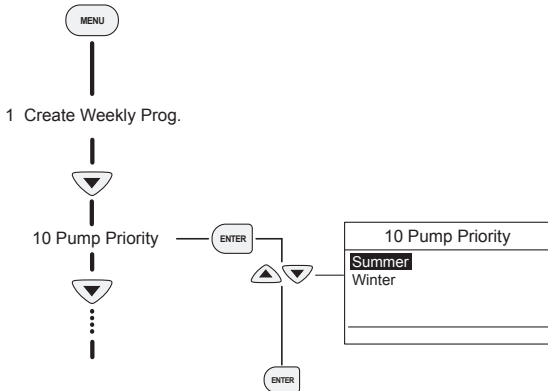

If during the plant operation the Priority Pump feature is disabled, the status of relays RL1 and RL2 is no longer controlled and remains as it previously was.



Use buttons to select the program to be activated.
Press to confirm activation.

IMPORTANT: Program active
 Program not active

- Total reset

The control is equipped with RESET function; the control will reset factory settings by pressing buttons  and  simultaneously for 5 seconds.

The control will go back to OFF status once RESET is executed.

Press  for 5 seconds to switch-on the control.

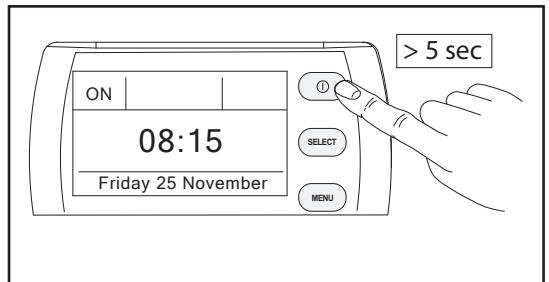
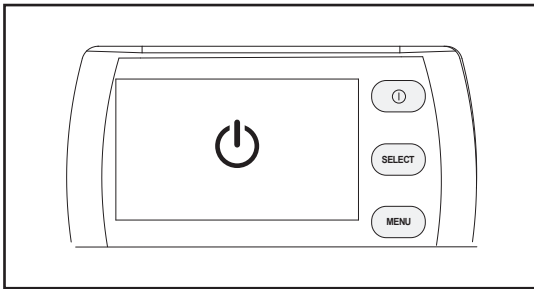
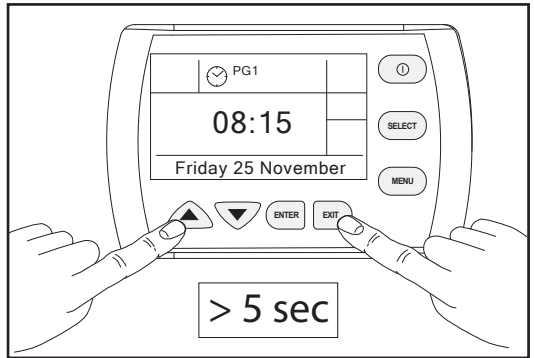

- Master/Slave with PSM-DI

Managing a group of appliances, via serial connection, with the T-MB control

It is possible to connect multiple devices controlling them simultaneously, transmitting settings from the T-MB control to a single MASTER unit.

All other units are defined SLAVE.

The operation of each individual appliance will depend, on the other hand, on the temperature conditions measured by each of these.

Whenever a serial network is set up, the end of the line must be defined by closing jumper MC2 on the last unit connected.

Note: The Master fan coil will have Dip 10 positioned on OFF, while all other devices connected as Slave will have Dip 10 positioned ON.

Serial Connection end network jumper

In the case of RS485 connection (Master/Slave) the network supplying the last machine should be disconnected.

Disconnection is made closing the Jumper MC2.

We recommend using a Belden 9841 cable for the RS 485 serial line

Network addresses

It is important for every unit to have an univocal address when an appliance network is set up, so that the PSM-DI control recognises it and, therefore, manages it.

Example configuration with No. 2 networks Master / Slave

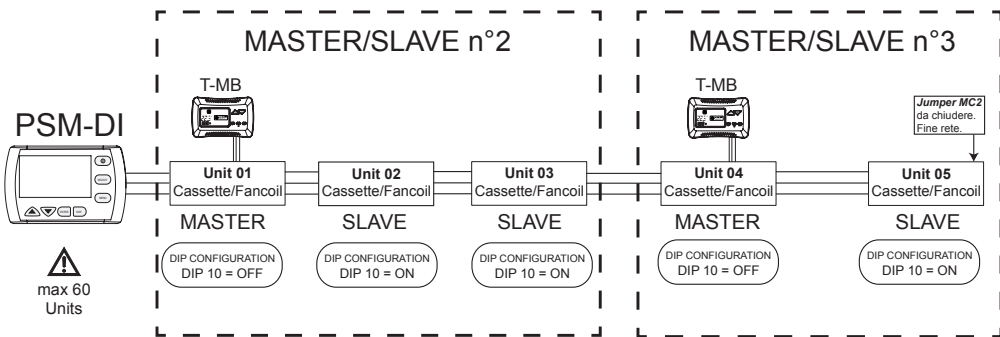

After making the connections and configurations dip cards, we create the Master / Slave network.

- Perform analysis system network from command PSM-DI as described previously (see the section of the manual).

- Verify that the command PSM-DI has detected all units.

- Access the menu **PARAMETERS**.

Press the Menu button and choose the function **parameters** using buttons \triangle ∇ and confirm using button ENTER .

NOTE: At this point you will have to set the number of Master / Slave network of belonging to each unit.

Proceed as follows:

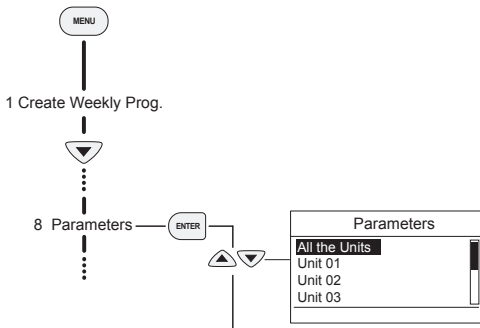

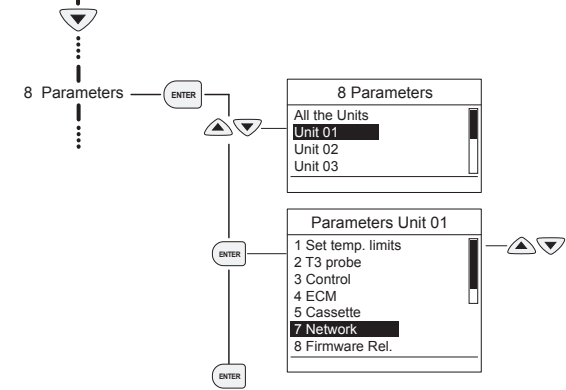

Choose the first unit to be set by pressing the keys and confirm with .

Once you select the unit, select the parameter "NETWORK" using the buttons .

Press to confirm choice.

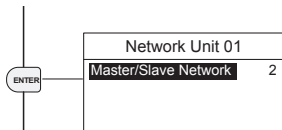

Press again and set by pressing the number of Master / Slave network desired (according to our example, the unit 01 belongs to the network No. 2).

IMPORTANT!: the identifier no. 1 to the Master / Slave network is not available).

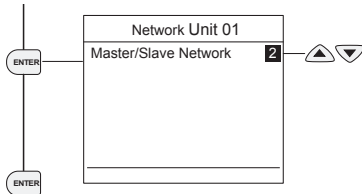

Press to confirm choice.

Perform the same setting for the other units (*units no. 02 and 03 belong to the network No. 2*).

For the units no. 04 and 05 proposed in the example must be set with Master / Slave network of belonging No. 3.

