

# Apply to T7/T10/T14/T17/T21 Tower Parallel Scheme



Important information:

1. Only qualified professional electricians can carry out the parallel connection of the Tower series and all other related work.
2. This solution is a brief description of Tower parallel connection, and cannot replace the original user manual.
3. The total voltage difference between clusters should be less than 10V; the SOC of each cluster should be 100%, and the time interval between new clusters and existing clusters should be less than 6 months.
4. Up to 5 Towers are allowed to be connected in parallel.

## I Parallel scheme introduction

In order to meet the market demand, Dyness has developed the parallel machine function of the Tower series. This parallel solution is applicable to all Tower models.

## II main equipment requirements

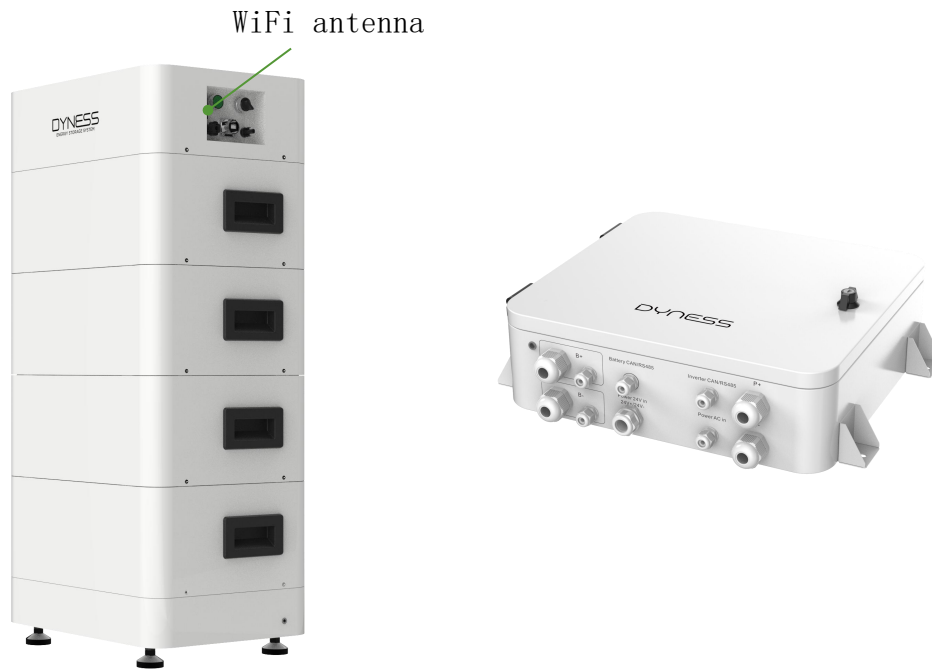

BDU-1.5G + Battery module + Base

Combiner box  
DCB-TW

① Parallel connection

The overall configuration diagram of the Tower parallel system is as follows:

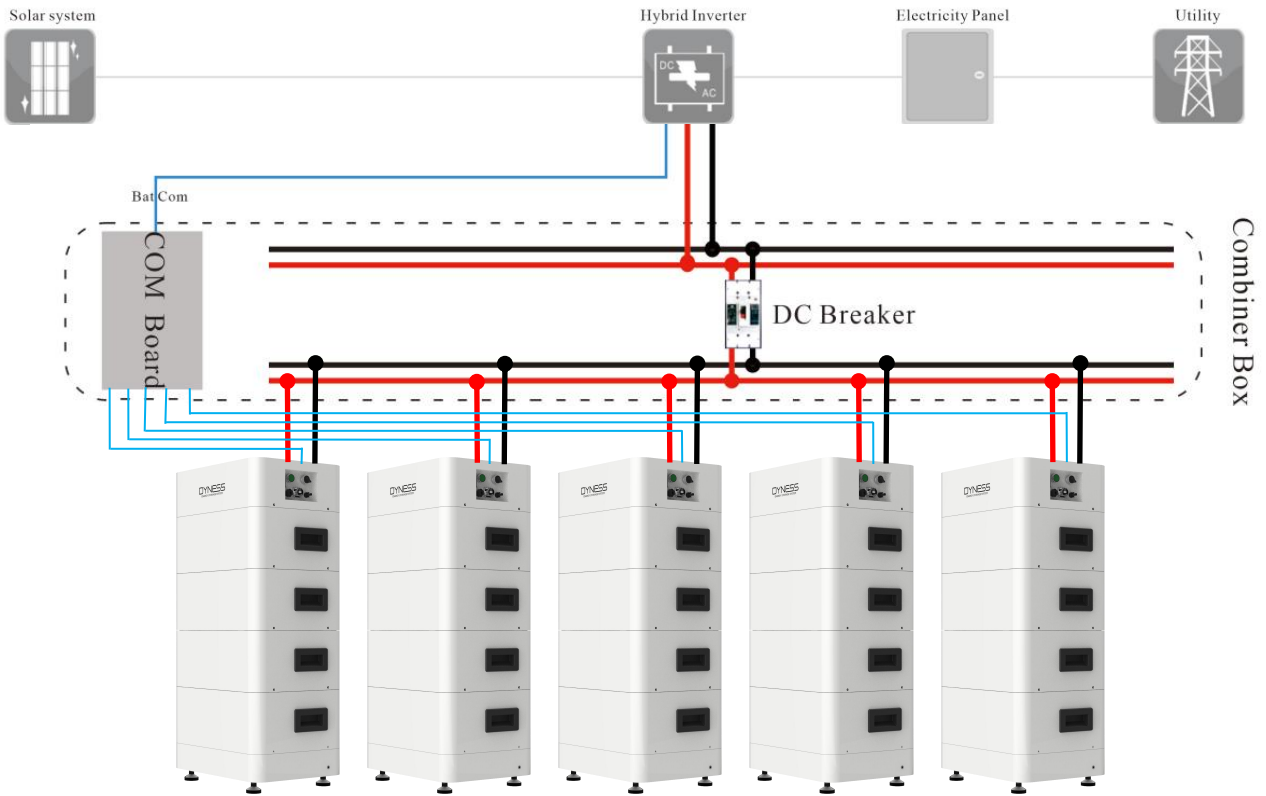

Overall configuration diagram of Tower

The wiring diagram between the Tower and the combiner box is as follows:

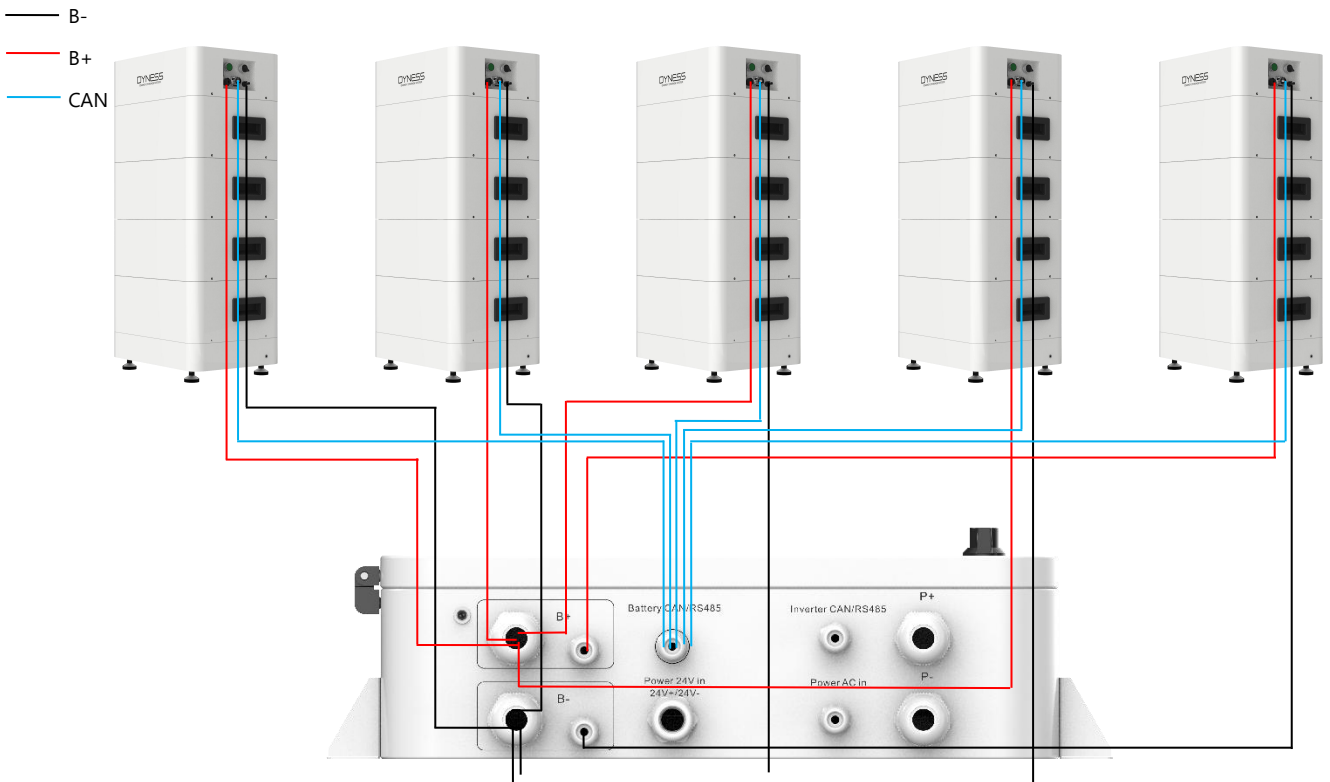

Connection diagram between Tower and Combiner Box

### III Power line connection of the battery terminal of the combiner box

1、Crimp one end of the BDU standard 6mm<sup>2</sup> power harness to the Phoenix waterproof connector terminal, and connect it to the socket of the BDU-1.5G:

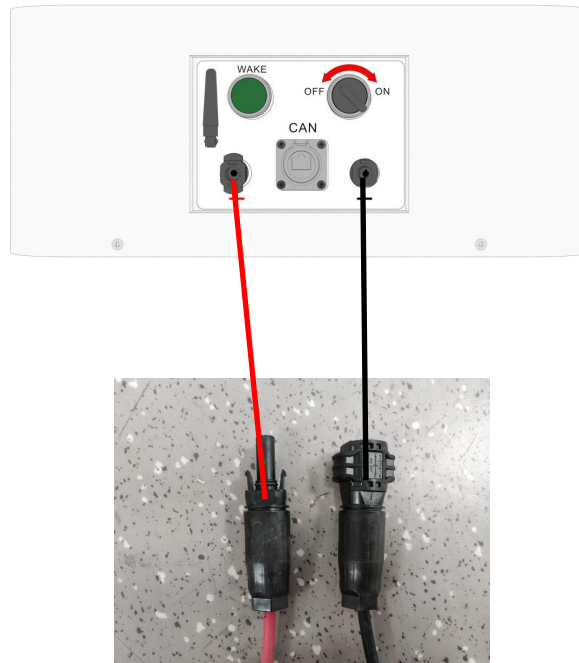

2、Strip the other end of the 6mm<sup>2</sup> power cable as shown in the figure below:



6mm<sup>2</sup> Power Line



Wire Stripper

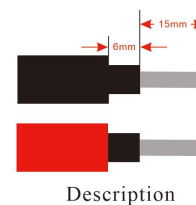
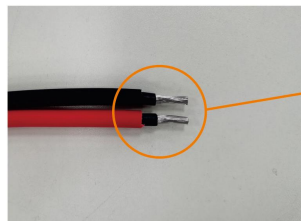

Description

3、Crimp the stripped 6mm<sup>2</sup> wire harness to the tube terminal:



4、Connect the 6mm<sup>2</sup> power harness with crimped tubular terminals to the B+ and B- ports of the combiner box according to the following steps:

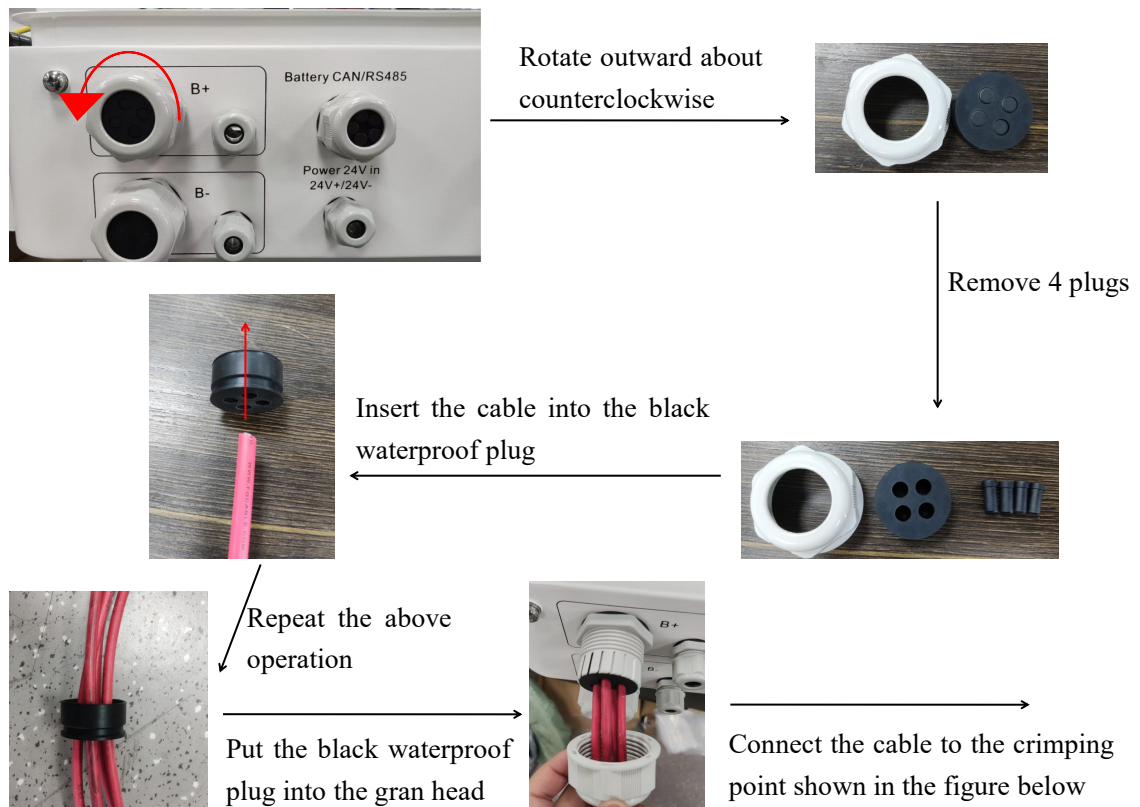

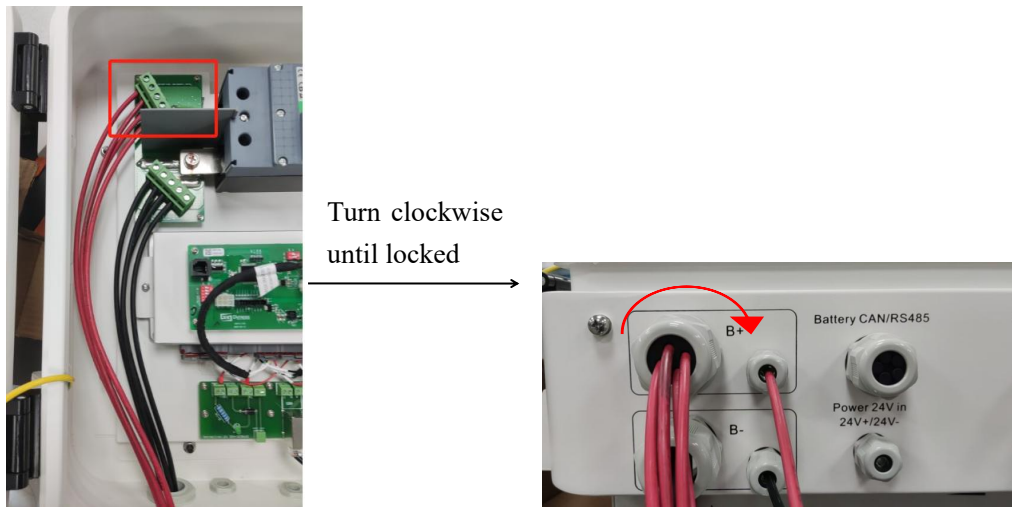

Repeat the above operation for the negative cable

5、 The schematic diagram of the connection of the power line at the battery end of the combiner box is shown below:

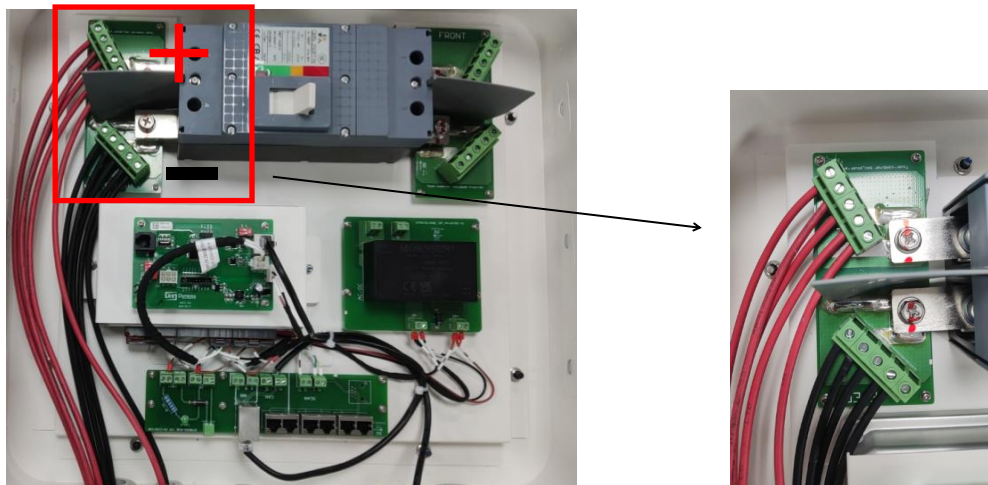

#### IV Connecting the communication cable at the battery end of the combiner box

Use standard communication network cables to connect the 4 clusters of Tower BDU-1.5G to the 1#, 2#, 3#, 4#, 5# interfaces of the combiner box respectively. Be careful not to connect to other ports.

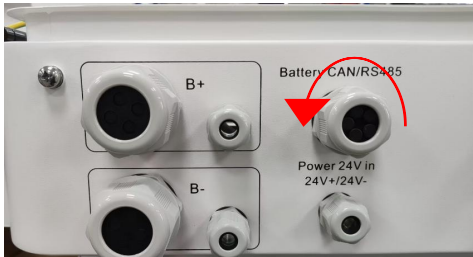
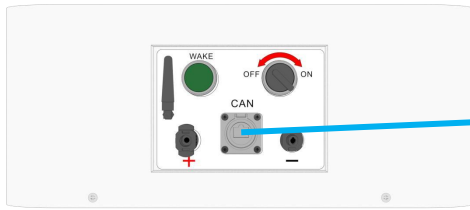

Rotate outward about counterclockwise, Remove 5 plugs



Put the standard Ethernet cable into the waterproof plug



Repeat the above operation



Put the black waterproof plug into the gran head



Insert standard communication network cables in order



Turn clockwise until locked



## V Connect the AC power cord or 24V power supply to the combiner box

### box

1. Connect the AC power cord to the combiner box



Insert the AC power cord into the slot shown below

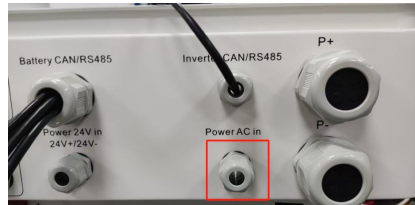

Connect the wiring harness to the L and N terminals

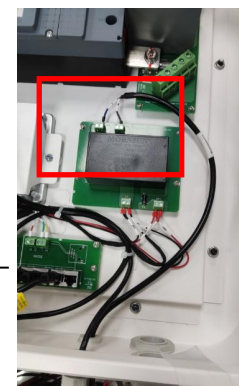

Turn clockwise until locked

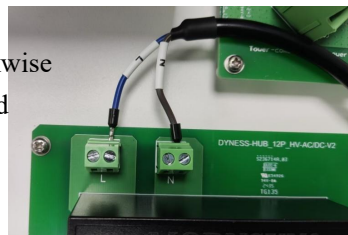

2. Connect the 24V power supply to the combiner box

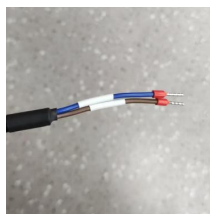

Insert the 24V power cord into the slot shown below



Connect the 24V power cord to the green terminal

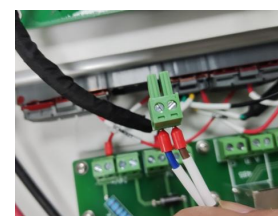

Turn clockwise until locked

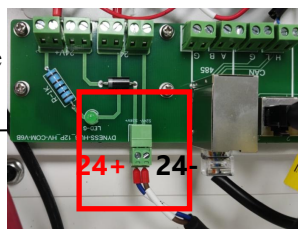

Insert 24V terminal position

**Only one of the AC power supply and 24V power supply can be used, and the simultaneous use of both is prohibited.**

## VI Connection between combiner box and inverter

1. The communication cable is connected to the communication terminal of the inverter through the "Inverter CAN/RS485" interface of the combiner box. The communication method depends on the inverter side (CAN or 485). Connected, can be used directly.

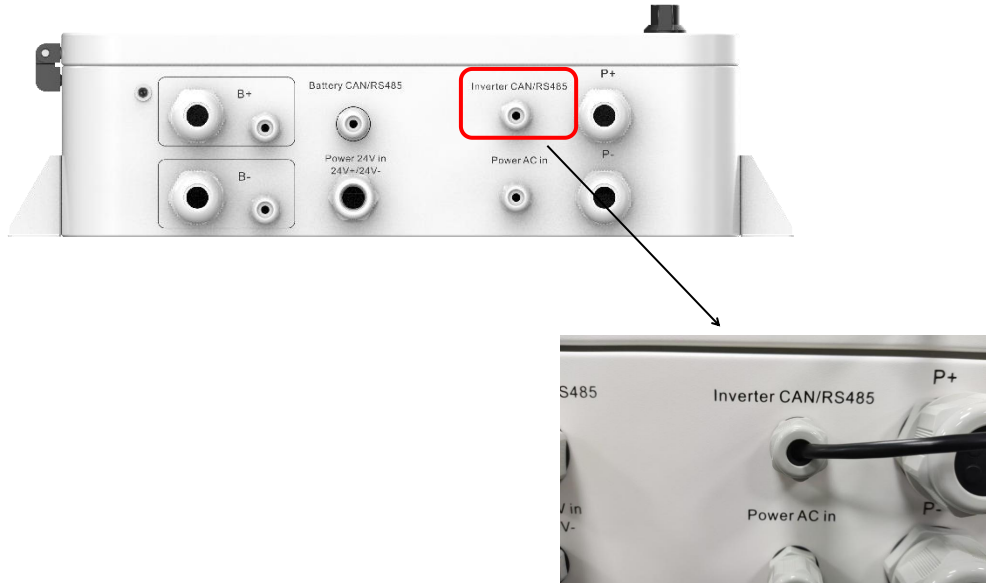

2. The style of the output power harness of the combiner box should be determined by the battery port of the inverter. Cables with an area of  $\leq 6\text{mm}^2$  can be crimped onto the terminal block; For cables larger than  $6\text{mm}^2$ , without considering waterproofing, the waterproof plug of the gland can be removed, and the power line can be connected to the copper busbar through a crimped OT terminal.

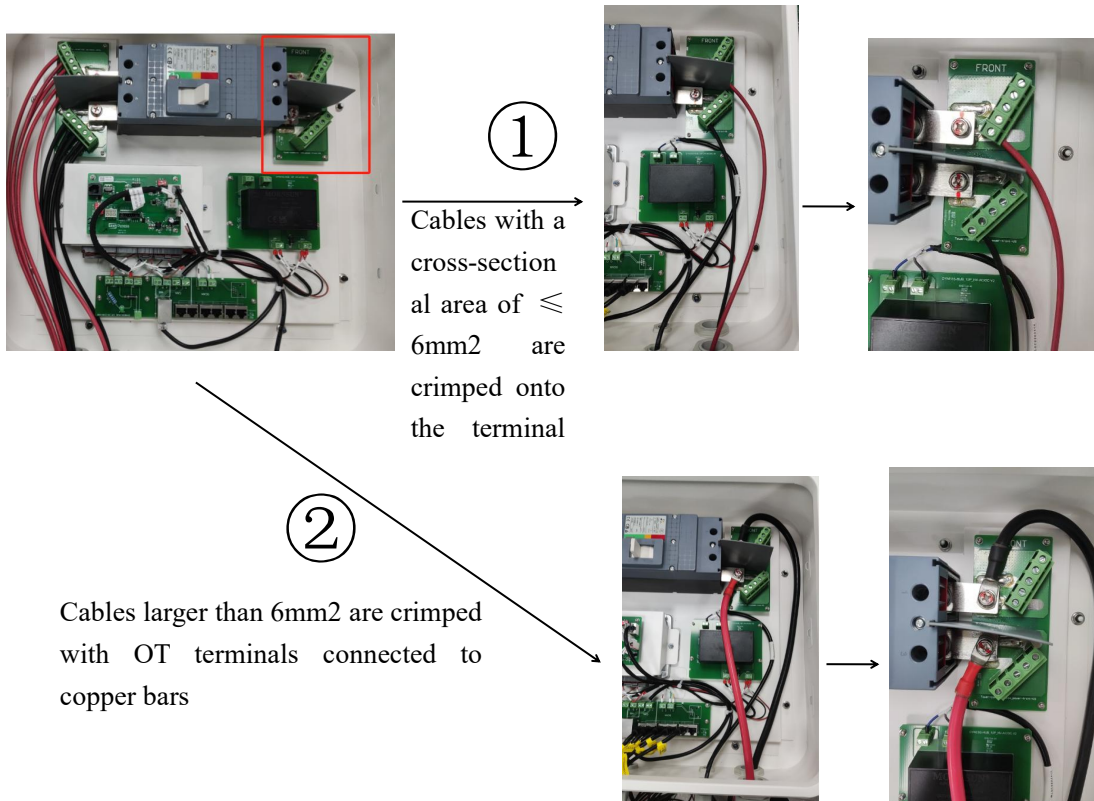

**Appendix:**

1. When Towers are connected in parallel, it is necessary to turn the DIP in the newly **added Tower BDU to the OFF state**, see the table below for details:

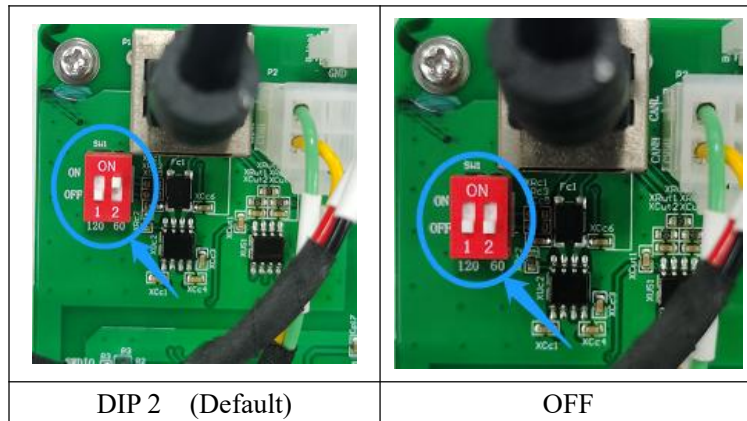

2. Set DIP switches (BDU-1.5G) for 3, 4, or 5 towers. The last cluster needs to set DIP switches to 120 (set 60 to OFF and 120 to ON), while the middle clusters do not need to be set (turn them all off). For detailed information, please refer to the table below:

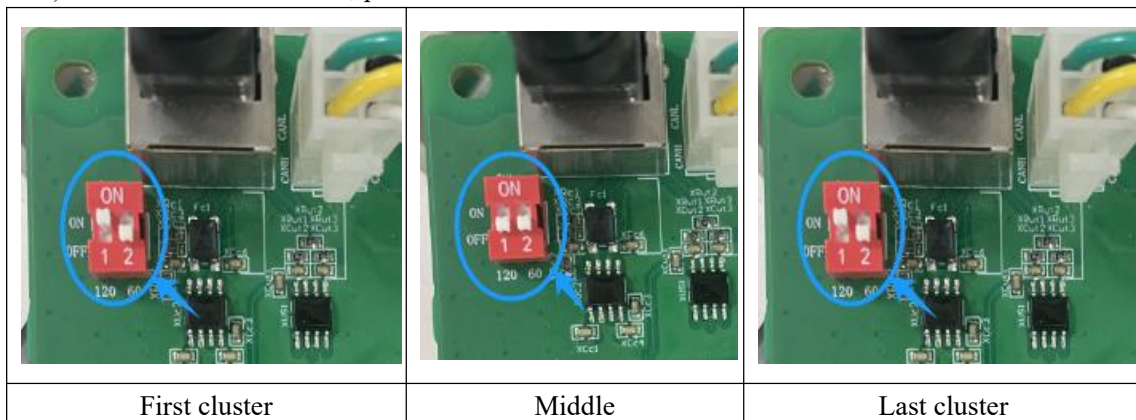

## VII Parallel System Start-up and Shutdown Sequence

### Start-up Sequence:

After the above power wiring harness and communication wiring harness are connected and inspected, push the left air switch of all cluster BDUs to the ON position, and push the DC Breaker in the combiner box from OFF to the ON position;

First turn the knob switch of cluster 1 BDU to the ON position, and press and hold the WAKE button for 8~9s to let go; then perform the same operation on the BDUs of cluster 2, cluster 3, cluster 4 and cluster 5. After all cluster BDUs are powered on, the combiner box After 10 seconds, all cluster BDUs will close the relays and output voltage externally.



### **Shutdown Sequence:**

First disconnect the AC power of the combiner box, and after about 7-8s, the BDU cuts off the output voltage; then turn the BDU knob switches of cluster 1, cluster 2, cluster 3, cluster 4 and cluster 5 to the OFF position.

If the battery is not used for a long time, you need to turn the switch on the left side of the BDU to the OFF position.

## **VIII Inverter Compatibility List**

See Dyness Compatibility List. Please contact Dyness for details if required.

## **IX Attention**

1. The protection level of DCB-TW is IP65.
2. Towers connected in parallel must have the same model and capacity.
3. The time interval between the newly added modules of Tower expansion and the existing modules cannot exceed 6 months. During capacity expansion, ensure that the SOC of each module is 100%.





Discover Your Nature



Official Website



Digital version access

Dyness Digital Energy Technology Co., LTD.

[www.dyness-tech.com](http://www.dyness-tech.com)