

ESVG 32 BK

Pressure compensation cable gland, polyamide, RAL 9005, M32

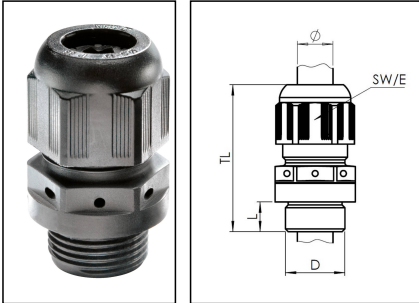

Products may differ in size, colour and appearance to those shown. If you require further information or customisation, please contact us directly.



Material cable gland	Polyamide
Material membrane	ePTFE
Material sealing gasket	EPDM
Airflow at 70mbar	115 l/h
Temp. range min	-40 °C
Temp. range max	100 °C
Glow wire test	750 °C
Protection class	IP68 / IP69
Thread type	M
Ø Connection thread D	32
Lead	1,5
Length screw-in thread L	12 mm
Ø cable diameter min	13 mm
Ø cable diameter max	21 mm
Key width SW	36 mm
Collar diameter (E)	40 mm
Install. torques fitting	4 N m
Install. torques cap nut	3 N m
Total length TL	49 mm - 58 mm
Equipment	Incl. connection thread gasket
Product Color	RAL 9005
Order no. RAL 9005	10100802
Type	ESVG 32 BK
Packing unit	1
EAN number	4007685047302

Your Contact:

WISKA Hoppmann GmbH

Kisdorfer Weg 28 · 24568 Kaltenkirchen · Germany

☎ +49-4191-508-0 · 📠 +49-4191-508-209

contact@wiska.de · www.wiska.com

Tariff number	39269097
ETIM-Classification	EC000441

Recommended accessories

EMUG 32 BK	10061784
RDE 32	10062186
BS 21	10064014
MFD 32/04/070	10064344
MFD 32/06/060	10064345
MFD 32/04/080	10064950
MFD 32/03/080	10101018
MFD 32/05/070	10101140
MFD 32/01/115-01/085	10101256
MFD 32/03/065	10102169
MFD 32/03/090	10102170

20.03.2025

Your Contact:

WISKA Hoppmann GmbH

Kisdorfer Weg 28 · 24568 Kaltenkirchen · Germany

☎ +49-4191-508-0 · 📠 +49-4191-508-209

contact@wiska.de · www.wiska.com

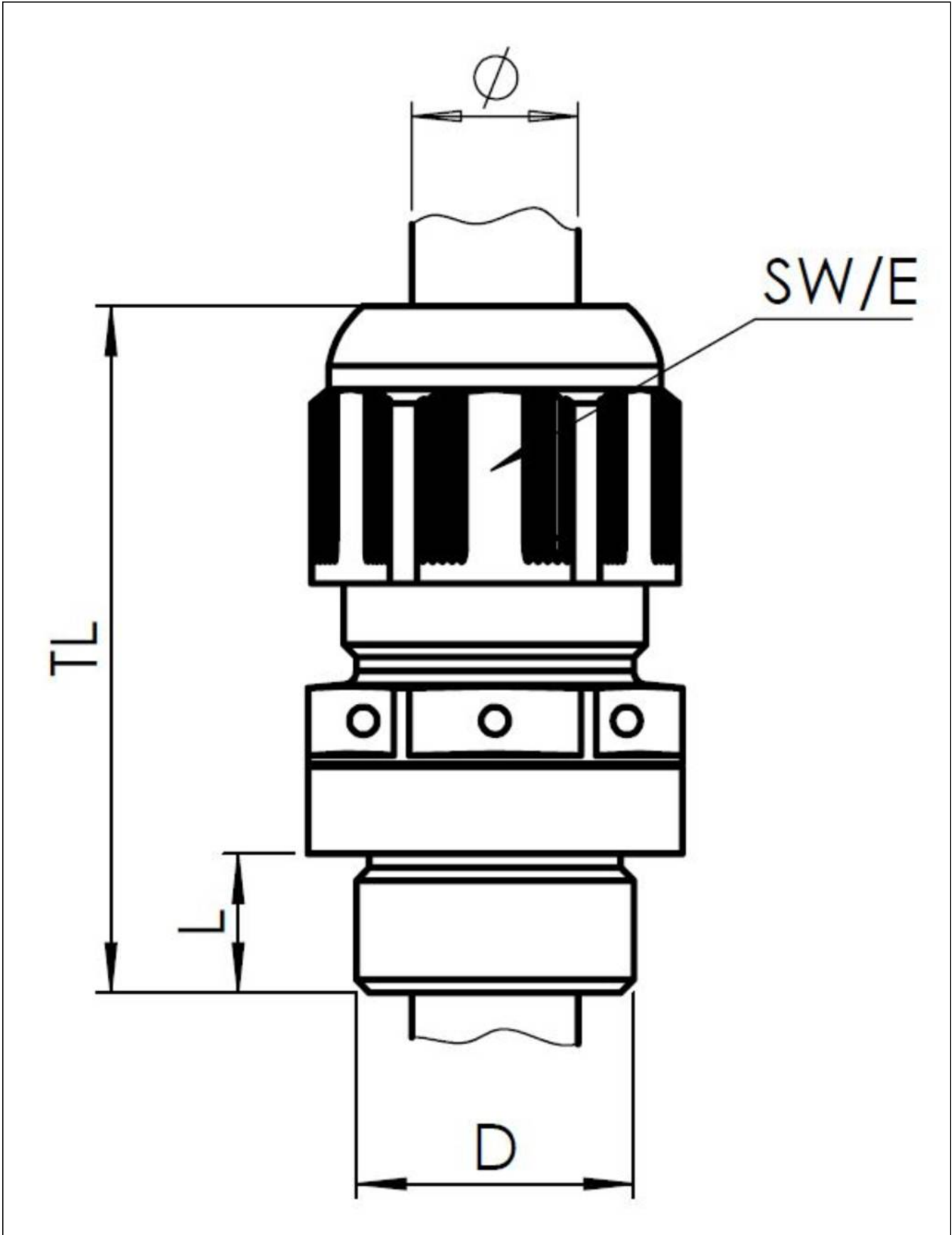

Your Contact:
WISKA Hoppmann GmbH
Kisdorfer Weg 28 · 24568 Kaltenkirchen · Germany
☎ +49-4191-508-0 · 📠 +49-4191-508-209
contact@wiska.de · www.wiska.com