

WDE002420, WDE003420,  
WDE004420, WDE002428,  
WDE002429

**Schneider**  
Electric

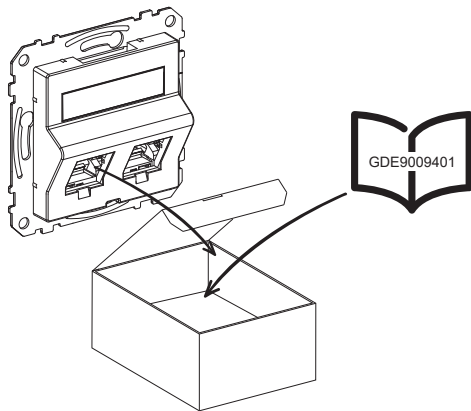

## For your safety / Käyttäjän turvallisuus / För din säkerhet / For din sikkerhet



### HAZARD OF ELECTRIC SHOCK, EXPLOSION, OR ARC FLASH

Safe electrical installation must be carried out only by skilled professionals. Skilled professionals must prove profound knowledge in the following areas:

- Connecting to installation networks
- Connecting several electrical devices
- Laying electric cables
- Safety standards, local wiring rules and regulations

**Failure to follow these instructions will result in death or serious injury.**

### SÄHKÖISKUN, RÄJÄHDYKSEN TAI VALOKAAREN VAARA

Turvallinen sähköasennuksen saavat suorittaa vain pätevät ammattilaiset. Pätevillä ammattilaisilla täytyy olla perusteelliset tiedot seuraavilla alueilla:

- asennusverkkoihin yhdistäminen
  - useiden sähkölaitteiden yhdistäminen
  - sähkökaapeleiden asentaminen
  - turvallisuusstandardit, paikalliset johdotussäännöt ja määräykset
- Näiden ohjeiden noudattamatta jättämisen seurauksena on kuolema tai vakavia vammoja.**

### RISK FÖR ELEKTRISK SHOCK, EXPLOSION OCH BÄGLIXT

Av säkerhetsskäl skall installation endast utföras av utbildad personal. Utbildad personal skall uppvisa djupt kunnande inom följande områden:

- Anslutning till installationsnätverk
- Anslutning till flera elektriska apparater
- Dragning av elkablar
- Säkerhetsstandarder samt lokala kabeldragningsföreskrifter och -regler.

**Om dessa instruktioner inte åtföljs kan det resultera i allvariga skador eller dödsfall.**

### FARE FOR ELEKTRISK STØT, EKSPLOSJON ELLER LYSBUE

Sikre elektroinstallasjoner må utelukkende utføres av kvalifisert personell. Kvalifisert personell må ha inngående kunnskap innen følgende områder:

- Tilkobling til installasjonsnettverk
- Tilkobling av flere elektriske enheter
- Legging av elektriske kabler
- Sikkerhetsstandarder, lokale regler og forskrifter for trekking av kabel

**Hvis disse instruksene ikke overholdes vil dette resultere i dødsfall eller alvorlige skader.**

## Locking System / Lukitusjärjestelmä / Infästningssystem / Låsesystem

S-One DPM: Side mounting / S-One DPM: Kiinnitys liittimen sivuilta /  
S-One DPM: Sidoinfästning / S-One DPM: Sideinnfesting

Keystone: Top and bottom mounting /  
Keystone: Kiinnitys liittimen ylä- ja alapuolelta /  
Keystone: Øvre og nedre fästpunkter /  
Keystone: Øvre og nedre festepunkter

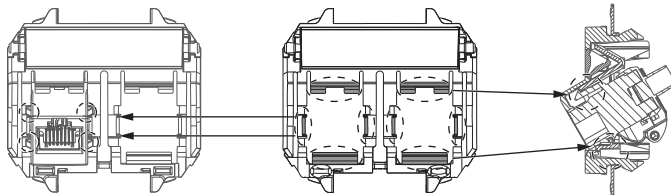

### Note:

1. Actassi S-One DPM connector footprint, fixed through side mechanism.
2. Keystone footprint connectors fixed through top and bottom mechanism.

### Huomautus:

1. Actassi S-One DPM-aukolliset liittimet kiinnitetään sivuilta.
2. Keystone-aukolliset liittimet kiinnitetään ylä- ja alapuolelta.

### Notera:

1. Actassi S-One DPM modularjack, montage via sidoinfästning.
2. Keystone hålbild, montage via övre och nedre fästpunkter.

### Merk:

1. Actassi S-One DPM-konnektor, monteres via sideinnfesting.
2. Keystone hålblide, monteres via øvre og nedre festepunkter.

## Unlocking / Lukituksen / Upplåsning / Unlocking

Removing S-One DPM /  
S-One DPM: n poistaminen /  
Demontera S-One DPM /  
Fjerne S-One DPM

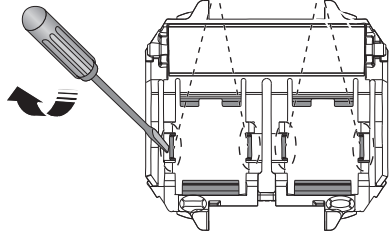

Removing keystone adaptor /  
Poistetaan avainkivi adaptor /  
Demontera keystone adaptor /  
Fjerner keystone adaptor

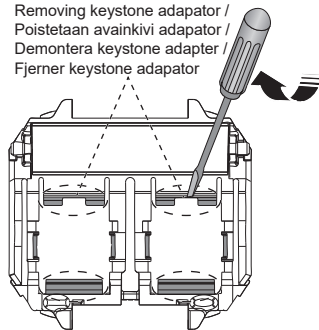

## Mounting Connectors / Asennusliittimet / Monteringskontakter / Monteringskontakter

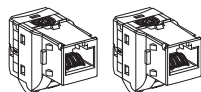

S-One DPM  
+  
S-One DPM

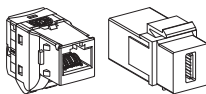

S-One DPM  
+  
USB Keystone adapter

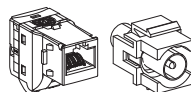

S-One DPM  
+  
IEC keystone adapter

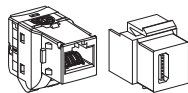

S-One DPM  
+  
HDMI Keystone adapter

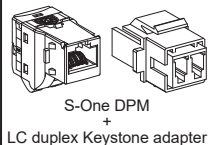

S-One DPM  
+  
LC duplex Keystone adapter

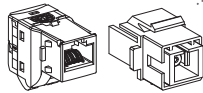

S-One DPM  
+  
SC simplex Keystone adapter

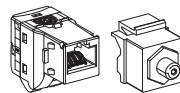
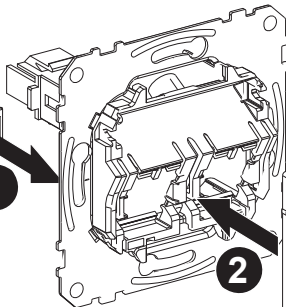

S-One DPM  
+  
F-Connector Keystone adapter

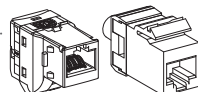

S-One DPM  
+  
Keystone connector

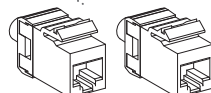

Keystone  
+  
Keystone

**Note:** Universal centre plate for Actassi S-One DPM and Keystone connectors/ adapters

**Huomautus:** Universaali keskiolevy Actassi S-One DPM- ja Keystone-liittimille / adapterille.

**Notera:** Universal centrumpatta för Actassi S-One DPM jack och Keystone jack / adapterar.

**Merk:** Universal senterplate for Actassi S-One DPM og Keystone konnektorer / adaptere

**Schneider Electric Industries SAS**

35 rue Joseph Monier, 92500 Rueil Malmaison - France

Phone: +33 (0) 1 41 29 70 00

www.se.com/contact

© 2020 Schneider Electric. All rights reserved

Released for Manufacturing  
Printed on 2020/10/20