

# 此页为技术要求，无需印刷

ES 商标, ES 商标,白色箱体, 两侧带不锈钢立柱, 带新款内部结构, 6/9/12KW 分体机内机+250L 多功能水箱(带板换)——AWST6/12-R32-S-V8 说明书技术要求

- 1.纸张边角应裁剪整齐;
- 2.印刷字迹清晰、美观, 字体、颜色、图案与附件中的内容一致, 无漏印、错印、印刷不清晰, 没有明显的拖墨和重影等缺陷;
- 3.说明书整洁, 无明显脏污、残缺;
- 4.材质: 双胶纸, 纸质为 80g/m<sup>2</sup>;
- 5.版面为 A4, 共 72P; 采用特殊胶装;
- 6.所有字体及图案均用灰度印刷。

中山市爱美泰电器有限公司					零部件名称	说明书	
					零部件编码	NCSMS00672A00	版本: C
设计	校对	审核	批准	存档	型号、规格	ES 商标, ES 商标,白色箱体, 两侧带不锈钢立柱, 带新款内部结构, 6/9/12KW 分体机内机 +250L 多功能水箱(带板换)——AWST6/12-R32-S-V8 说明书	
					首次使用机型		1/1



**AWST6/12-R32-S-V8**

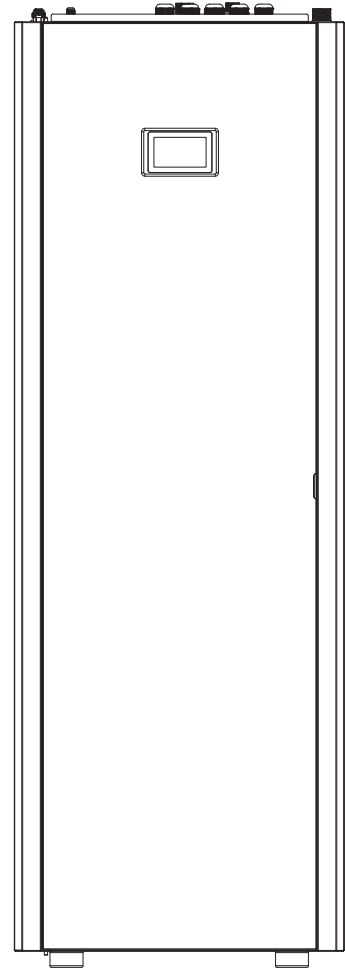
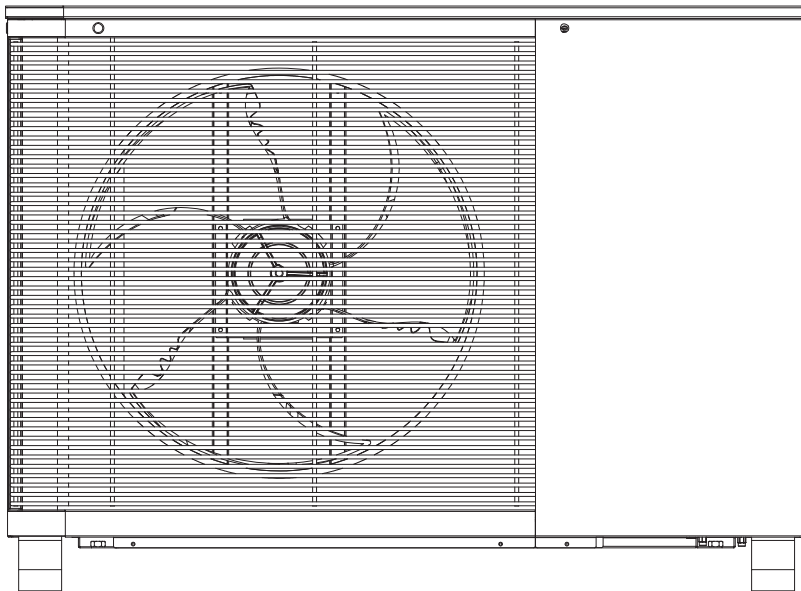

# **DC Inverter Air to Water Heat Pump**

---

# **User's manual**

**Before operating this product, please read the instructions carefully and keep this manual for future use.**



# Catalogue

<b>1.Before use</b> .....	<b>4</b>
1.1.Advanced Important Notice .....	4
<b>2.Introduction</b> .....	<b>11</b>
2.1.Preliminary Information .....	11
2.2.Safety Precautions .....	12
2.3.Functioning Principles .....	14
2.4.Product Component Diagram .....	15
2.5.Technical Specifications .....	16
<b>3.Overview of the Units</b> .....	<b>18</b>
3.1.Functional Diagrams .....	18
3.2.Outlines and Dimensions .....	20
3.3.Exploded Views .....	23
<b>4.Assembly Configurations</b> .....	<b>24</b>
Assembly Configuration Selection Flowchart .....	24
Assembly Drawings, Wiring, and Software .....	25
<b>5.Installation Walkthrough</b> .....	<b>40</b>
5.1.Sanitary Hot Water Applications .....	40
5.2.Heating and Cooling Circuits .....	41
5.3.Indoor Unit Installation .....	44
5.4.Outdoor Unit Installation .....	45
5.5.Refrigerant pipe connection and water pipe connection .....	47
5.6.Installation of the kits in the accessories .....	52
5.7.Wiring .....	53
5.8.Attention .....	62
5.9.Electric heating .....	63
5.10.Test Run .....	65
5.11. Circulating pump .....	66
<b>6.Appendix</b> .....	<b>68</b>
A. Wiring .....	68
B. Wiring Diagrams .....	70



# 1. Before use

## 1.1 Advanced Important Notice

### Cautions:

1. Do not use means to accelerate the defrosting process or to clean, other than those recommended by the manufacturer.
2. The appliance shall be stored in a room without continuously operating ignition sources (for example: open flames, an operating gas appliance or an operating electric heater.).
3. Do not pierce or burn.
4. Be aware that refrigerants may not contain an odour.
5. Appliance shall be installed, operated and stored in a room with a floor area larger than X m<sup>2</sup> (refer to specifications sheet).
6. The installation of pipe-work shall be kept to a minimum X m<sup>2</sup> (refer to specifications sheet).
7. Spaces where refrigerant pipes shall be compliance with national gas regulations.
8. Servicing shall be performed only as recommended by the manufacturer.
9. The appliance shall be stored in a well-ventilated area where the room size corresponds to the room area as specified for operation.
10. All working procedure that affects safety means shall only be carried by competent persons.

### General Notice:

#### 1. Transport of equipment containing flammable refrigerants

Compliance with the transport regulations

#### 2. Marking of equipment using signs

Compliance with local regulations

#### 3. Disposal of equipment using flammable refrigerants

Compliance with national regulations

#### 4. Storage of equipment/appliances

The storage of equipment should be in accordance with the manufacturer's instructions.

#### 5. Storage of packed (unsold) equipment

Storage package protection should be constructed such that mechanical damage to the equipment inside the package will not cause a leak of the refrigerant charge.

The maximum number of pieces of equipment permitted to be stored together will be determined by local regulations.

#### 6. Information on servicing

##### 1) Checks to the area

Prior to beginning work on systems containing flammable refrigerants, safety checks are necessary to ensure that the risk of ignition is minimised. For repair to the refrigerating system, the following precautions shall be complied with prior to conducting work on the system.

##### 2) Work procedure

Work shall be undertaken under a controlled procedure so as to minimise the risk of a flammable gas or vapour being present while the work is being performed.

# 1. Before use

## 3) General work area

All maintenance staff and others working in the local area shall be instructed on the nature of work being carried out. Work in confined spaces shall be avoided. The area around the workspace shall be sectioned off. Ensure that the conditions within the area have been made safe by control of flammable material.

## 4) Checking for presence of refrigerant

The area shall be checked with an appropriate refrigerant detector prior to and during work, to ensure the technician is aware of potentially flammable atmospheres. Ensure that the leak detection equipment being used is suitable for use with flammable refrigerants, i.e. non-sparking, adequately sealed or intrinsically safe.

## 5) Presence of fire extinguisher

If any hot work is to be conducted on the refrigeration equipment or any associated parts, appropriate fire extinguishing equipment shall be available to hand. Have a dry powder or CO<sub>2</sub> fire extinguisher adjacent to the charging area.

## 6) No ignition sources

No person carrying out work in relation to a refrigeration system which involves exposing any pipe work that contains or has contained flammable refrigerant shall use any sources of ignition in such a manner that it may lead to the risk of fire or explosion. All possible ignition sources, including cigarette smoking, should be kept sufficiently far away from the site of installation, repairing, removing and disposal, during which flammable refrigerant can possibly be released to the surrounding space. Prior to work taking place, the area around the equipment is to be surveyed to make sure that there are no flammable hazards or ignition risks. "No Smoking" signs shall be displayed.

## 7) Ventilated area

Ensure that the area is in the open or that it is adequately ventilated before breaking into the system or conducting any hot work. A degree of ventilation shall continue during the period that the work is carried out. The ventilation should safely disperse any released refrigerant and preferably expel it externally into the atmosphere.

## 8) Checks to the refrigeration equipment

Where electrical components are being changed, they shall be fit for the purpose and to the correct specification. At all times the manufacturer's maintenance and service guidelines shall be followed. If in doubt consult the manufacturer's technical department for assistance. The following checks shall be applied to installations using flammable refrigerants:

- The charge size is in accordance with the room size within which the refrigerant containing parts are installed;
- The ventilation machinery and outlets are operating adequately and are not obstructed;
- If an indirect refrigerating circuit is being used, the secondary circuit shall be checked for the presence of refrigerant;
- Marking to the equipment continues to be visible and legible. Markings and signs that are illegible shall be corrected;
- Refrigeration pipe or components are installed in a position where they are unlikely to be exposed to any substance which may corrode refrigerant containing components, unless the components are constructed of materials which are inherently resistant to being corroded or are suitably protected against being so corroded.

# 1. Before use

## 9) Checks to electrical devices

Repair and maintenance to electrical components shall include initial safety checks and component inspection procedures. If a fault exists that could compromise safety, then no electrical supply shall be connected to the circuit until it is satisfactorily dealt with. If the fault cannot be corrected immediately but it is necessary to continue operation, an adequate temporary solution shall be used. This shall be reported to the owner of the equipment so all parties are advised.

Initial safety checks shall include:

- .That capacitors are discharged: this shall be done in a safe manner to avoid possibility of sparking;
- .That there no live electrical components and wiring are exposed while charging, recovering or purging the system;
- .That there is continuity of earth bonding.

## 7.Repairs to sealed components

1)During repairs to sealed components, all electrical supplies shall be disconnected from the equipment being worked upon prior to any removal of sealed covers, etc. If it is absolutely necessary to have an electrical supply to equipment during servicing, then a permanently operating form of leak detection shall be located at the most critical point to warn of a potentially hazardous situation.

2) Particular attention shall be paid to the following to ensure that by working on electrical components, the casing is not altered in such a way that the level of protection is affected. This shall include damage to cables, excessive number of connections, terminals not made to original specification, damage to seals, incorrect fitting of glands, etc.

Ensure that apparatus is mounted securely.

Ensure that seals or sealing materials have not degraded such that they no longer serve the purpose of preventing the ingress of flammable atmospheres. Replacement parts shall be in accordance with the manufacturer's specifications.

NOTE: The use of silicon sealant may inhibit the effectiveness of some types of leak detection equipment. Intrinsically safe components do not have to be isolated prior to working on them.

## 8.Repair to intrinsically safe components

Do not apply any permanent inductive or capacitance loads to the circuit without ensuring that this will not exceed the permissible voltage and current permitted for the equipment in use.

Intrinsically safe components are the only types that can be worked on while live in the presence of a flammable atmosphere. The test apparatus shall be at the correct rating.

Replace components only with parts specified by the manufacturer. Other parts may result in the ignition of refrigerant in the atmosphere from a leak.

# 1. Before use

---

## **9.Cablling**

Check that cabling will not be subject to wear, corrosion, excessive pressure, vibration, sharp edges or any other adverse environmental effects. The check shall also take into account the effects of aging or continual vibration from sources such as compressors or fans.

## **10.Detection of flammable refrigerants**

Under no circumstances shall potential sources of ignition be used in the searching for or detection of refrigerant leaks. A halide torch (or any other detector using a naked flame) shall not be used.

## **11.Leak detection methods**

The following leak detection methods are deemed acceptable for systems containing flammable refrigerants.

Electronic leak detectors shall be used to detect flammable refrigerants, but the sensitivity may not be adequate, or may need re-calibration. (Detection equipment shall be calibrated in a refrigerant-free area.) Ensure that the detector is not a potential source of ignition and is suitable for the refrigerant used. Leak detection equipment shall be set at a percentage of the LFL of the refrigerant and shall be calibrated to the refrigerant employed and the appropriate percentage of gas (25% maximum) is confirmed.

Leak detection fluids are suitable for use with most refrigerants but the use of detergents containing chlorine shall be avoided as the chlorine may react with the refrigerant and corrode the copper pipe-work.

If a leak is suspected, all naked flames shall be removed/ extinguished.

If a leakage of refrigerant is found which requires brazing, all of the refrigerant shall be recovered from the system, or isolated (by means of shut off valves) in a part of the system remote from the leak. Oxygen free nitrogen (OFN) shall then be purged through the system both before and during the brazing process.

## **12.Removal and evacuation**

When breaking into the refrigerant circuit to make repairs – or for any other purpose –conventional procedures shall be used. However, it is important that best practice is followed since flammability is a consideration. The following procedure shall be adhered to:

- Remove refrigerant;
- Purge the circuit with inert gas;
- Evacuate;
- Purge again with inert gas;
- Open the circuit by cutting or brazing.

The refrigerant charge shall be recovered into the correct recovery cylinders. The system shall be “flushed” with OFN to render the unit safe. This process may need to be repeated several times. Compressed air or oxygen shall not be used for this task.

Flushing shall be achieved by breaking the vacuum in the system with OFN and continuing to fill until the working pressure is achieved, then venting to atmosphere, and finally pulling down to a vacuum. This process shall be repeated until no refrigerant is within the system. When the final OFN charge is used, the system shall be vented down to atmospheric pressure to enable work to take place. This operation is absolutely vital if brazing operations on the pipe-work are to take place. Ensure that the outlet for the vacuum pump is not close to any ignition sources and there is ventilation available.

# 1. Before use

## 13. Charging procedures

In addition to conventional charging procedures, the following requirements shall be followed.

- Ensure that contamination of different refrigerants does not occur when using charging equipment. Hoses or lines shall be as short as possible to minimise the amount of refrigerant contained in them.
- Cylinders shall be kept upright.
- Ensure that the refrigeration system is earthed prior to charging the system with refrigerant.
- Label the system when charging is complete (if not already).
- Extreme care shall be taken not to overfill the refrigeration system.

Prior to recharging the system it shall be pressure tested with OFN. The system shall be leak tested on completion of charging but prior to commissioning. A follow up leak test shall be carried out prior to leaving the site.

## 14. Decommissioning

Before carrying out this procedure, it is essential that the technician is completely familiar with the equipment and all its detail. It is recommended good practice that all refrigerants are recovered safely. Prior to the task being carried out, an oil and refrigerant sample shall be taken in case analysis is required prior to re-use of reclaimed refrigerant. It is essential that electrical power is available before the task is commenced.

- a) Become familiar with the equipment and its operation.
- b) Isolate system electrically.
- c) Before attempting the procedure ensure that:
  - .Mechanical handling equipment is available, if required, for handling refrigerant cylinders;
  - .All personal protective equipment is available and being used correctly;
  - .The recovery process is supervised at all times by a competent person;
  - .Recovery equipment and cylinders conform to the appropriate standards.
- d) Pump down refrigerant system, if possible.
- e) If a vacuum is not possible, make a manifold so that refrigerant can be removed from various parts of the system.
- f) Make sure that cylinder is situated on the scales before recovery takes place.
- g) Start the recovery machine and operate in accordance with manufacturer's instructions.
- h) Do not overfill cylinders. (No more than 80% volume liquid charge).
- I) Do not exceed the maximum working pressure of the cylinder, even temporarily.
- j) When the cylinders have been filled correctly and the process completed, make sure that the cylinders and the equipment are removed from site promptly and all isolation valves on the equipment are closed off.
- k) Recovered refrigerant shall not be charged into another refrigeration system unless it has been cleaned and checked.

## 15. Labelling

Equipment shall be labelled stating that it has been de-commissioned and emptied of refrigerant. The label shall be dated and signed. Ensure that there are labels on the equipment stating the equipment contains flammable refrigerant.

## 16. Recovery

When removing refrigerant from a system, either for servicing or decommissioning, it is recommended good practice that all refrigerants are removed safely.

When transferring refrigerant into cylinders, ensure that only appropriate refrigerant recovery cylinders are employed. Ensure that the correct number of cylinders for holding

# 1. Before use

---

the total system charge is available. All cylinders to be used are designated for the recovered refrigerant and labelled for that refrigerant (i.e. special cylinders for the recovery of refrigerant). Cylinders shall be complete with pressure relief valve and associated shut-off valves in good working order. Empty recovery cylinders are evacuated and, if possible, cooled before recovery occurs. The recovery equipment shall be in good working order with a set of instructions concerning the equipment that is at hand and shall be suitable for the recovery of flammable refrigerants. In addition, a set of calibrated weighing scales shall be available and in good working order. Hoses shall be complete with leak-free disconnect couplings and in good condition. Before using the recovery machine, check that it is in satisfactory working order, has been properly maintained and that any associated electrical components are sealed to prevent ignition in the event of a refrigerant release.

Consult manufacturer if in doubt.

The recovered refrigerant shall be returned to the refrigerant supplier in the correct recovery cylinder, and the relevant Waste Transfer Note arranged. Do not mix refrigerants in recovery units and especially not in cylinders.















If compressors or compressor oils are to be removed, ensure that they have been evacuated to an acceptable level to make certain that flammable refrigerant does not remain within the lubricant. The evacuation process shall be carried out prior to returning the compressor to the suppliers. Only electric heating to the compressor body shall be employed to accelerate this process. When oil is drained from a system, it shall be carried out safely.



# Included Accessories



Below are the accessories that are included with your purchase. Please check to ensure that none are missing or damaged. If so, please contact your local distributor.

<b>1</b>		<b>2</b>		<b>3</b>		<b>4</b>		<b>5</b>	
X1		X1		X1		X1		X1	
									
Installation Manual		User's Manual		Mixing Circuit 1 Temperature Sensor		Extension cable for Mixing Circuit 1 Temperature Sensor		Mixing Circuit 2 Temperature Sensor	
<b>6</b>		<b>7</b>		<b>8</b>		<b>9</b>		<b>10</b>	
X1		X1		X1		X1		X1	
									
Extension cable for Mixing Circuit 2 Temperature Sensor		TR-Room Temperature Sensor		Extension cable for Room Temperature Sensor		Communication Cable between Indoor and Outdoor Unit		Automatic air purging valve	
<b>11</b>		<b>12</b>		<b>13</b>		<b>14</b>			
X2		X2		X1		X1			
									
5/8" nut		3/8" nut		TC-Heating/cooling temp. sensor		Extension cables for TC			

## 2. Introduction

---

### 2.1 Preliminary Information

---

Thank you for your purchase of our quality heat pump.

This manual is intended to provide detailed instructions for the successful installation of your newly purchased heat pump product. Please ensure that this manual, along with the User's and Service manuals, are kept in an easy-to-access location for your reference later on.

#### DISCLAIMER

Proper adherence to the directions provided herein is vital for both the smooth operation of this system, as well as for your safety and the safety of those around you. ES Heat Pumps AB. is not responsible or liable for any losses incurred due to misuse or mishandling of this product, which includes, but is not limited to:

- Purchasing, installing, and/or operating this product with the intention of using it outside of its established, technical purpose.
- Carrying out improper work upon the unit, or any of its components, that has not been given explicit, prior consent in the form of writing.
- Installation attempts of this system by anyone other than a properly trained and licensed professional.
- Negligence of properly-worn personal protection (safety glasses, gloves, etc.) while performing installation, maintenance, or servicing of this product.
- The operation of this system during ambient temperatures which are below or beyond the temperature range intended (-25°C to 45°C)

#### SAFETY

If unsure of what installation procedures to use, please contact your local distributor for information and/or advisement. Any accessories used with this product must be official only. Any electrical work must be carried out by certified electricians only. The manufacturer is not responsible for any alterations or modifications that are made without explicit, written approval. The design of this unit complies and conforms to all necessary and relevant safety regulations, and is otherwise safe to operate for its intended use.

Please pay attention to the following pages, which detail important precautions that should be closely followed, to ensure safe installation and operation .



## 2. Introduction

### 2.2.Safety Precautions

To ensure both your personal safety, as well as the safety of the product, note the symbols below and be sure to understand their correlation to each of the precautions depicted.





Warning





Caution

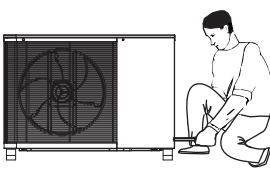



Prohibition

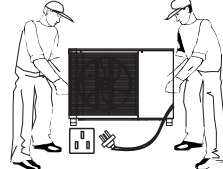

The installation, dismantlement and maintenance of the unit must be performed by qualified personnel. It is forbidden to do any changes to the structure of the unit. Otherwise injury of person or unit damage might happen.



To avoid electrical shock, make sure to disconnect the power supply 1 minute or more before servicing the electrical parts. Even after 1 minute, always measure the voltage at the terminals of main circuit capacitors or electrical parts and, before touching, make sure that those voltages are lower than the safety voltage.

Be sure to read this manual before use.

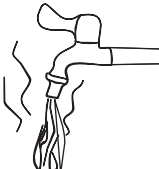

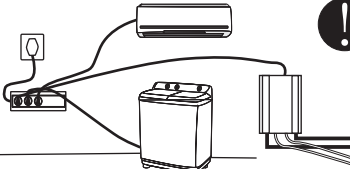

For sanitary hot water, please always add a mixture valve before water tap and set it to proper temperature.



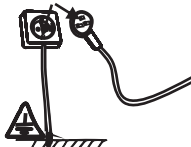

Use a dedicated socket for this unit, otherwise malfunction may occur.



Ground wire



The power supply to the unit must be grounded.

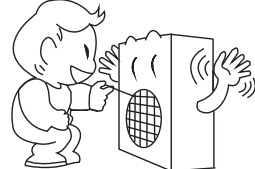

This appliance can be used by children aged from 8 years and above and persons with reduced physical, sensory or mental capabilities or lack of experience and knowledge if they have been given supervision or instruction concerning use of the appliance in a safe way and understand the hazards involved. Children shall not play with the appliance. Cleaning and user maintenance shall not be made by children without supervision.

Do not touch the air outlet grill when fan motor is running.



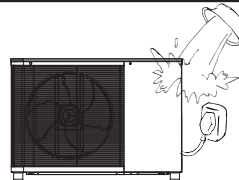

Do not touch the power plug with wet hands. Never pull out the plug by pulling the power cable.

Water or any kind of liquid is strictly forbidden to be poured into the product, or may cause electric creepage or breakdown of the product.

## 2. Introduction

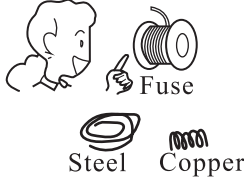
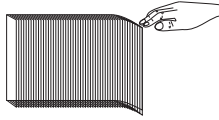
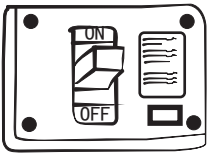
### 2.2.Safety Precautions

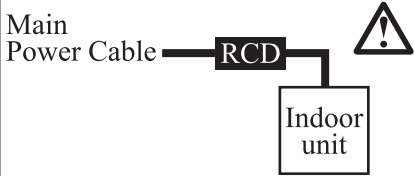
 <p>When the power cord gets loose or damaged, always get a qualified person to fix it.</p>	 <p>Please select the correct fuse or breaker as per recommended. Steel wire or copper wire cannot be taken as substitute for fuse or breaker. Otherwise, damages maybe caused.</p>	 <p>Be aware fingers might be hurt by the fin of the coil.</p>
 <p>It is mandatory to use a suitable circuit breaker for the heat pump and make sure the power supply to the unit corresponds to the specifications. Otherwise the unit might be damaged.</p>	 <p>Disposal of Scrap Batteries (if there is) . Please discard the batteries as sorted municipal waste at the accessible collection point.</p>	 <p>Installation of a residual current device (RCD) having a rated residual operating current not exceeding 30 mA is advisable.</p>
<p> <b>System water filling</b></p> 		
<p>1. It's suggested to use pure water for filling the system.          2. If use city water for filling, please soften the water and add a filter.          Note: After filling, the system of water system should be 0.15~0.6MPa.</p>		
	<p>This marking indicates that this product should not be disposed with other household wastes throughout the EU. To prevent possible harm to the environment or human health from uncontrolled waste disposal, recycle it responsibly to promote the sustainable reuse of material resources. To return your used device, please use the return and collection systems or contact the retailer where the product was purchased. They can take this product for environmental safe recycling.</p>	

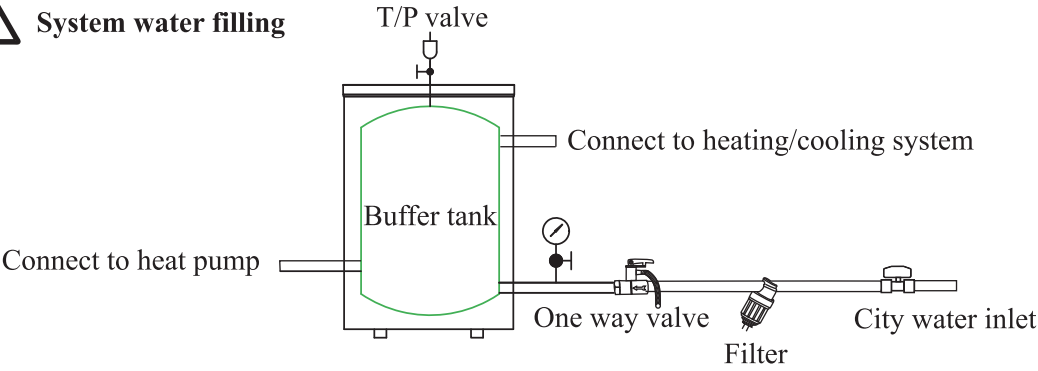
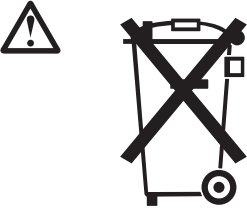
## 2. Introduction

### 2.3. Functioning Principles

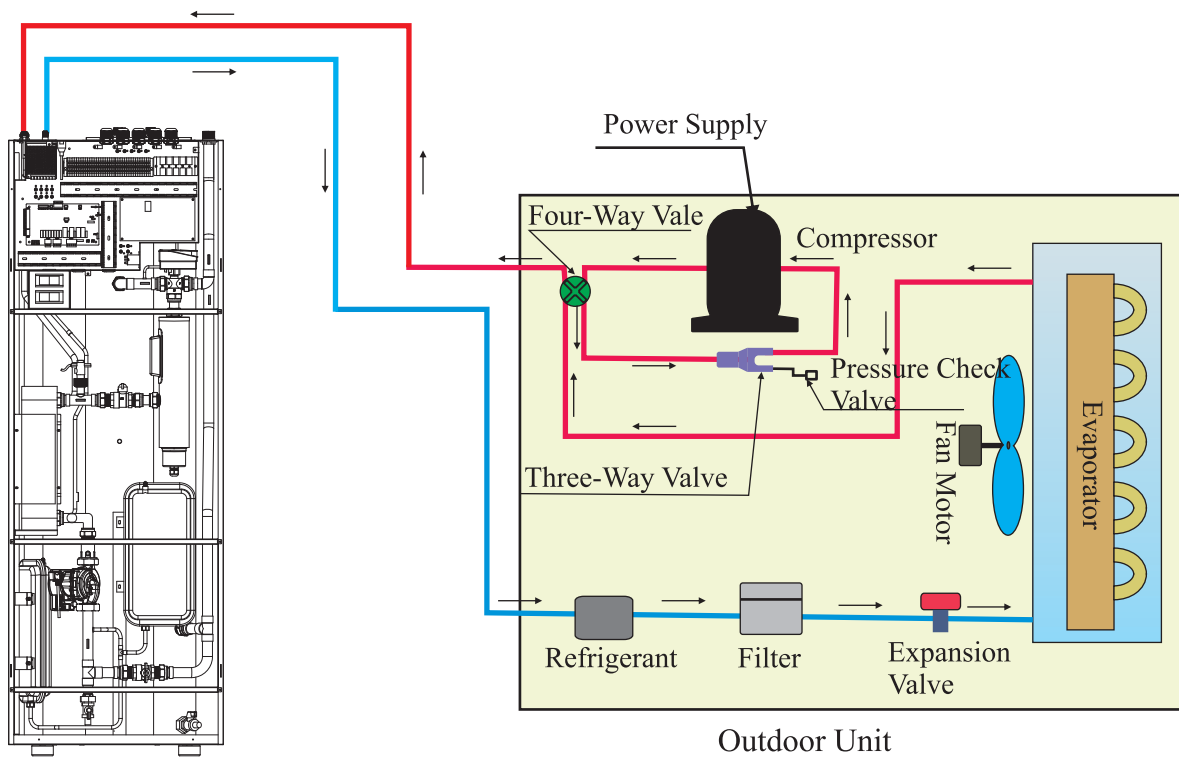

#### System sketch

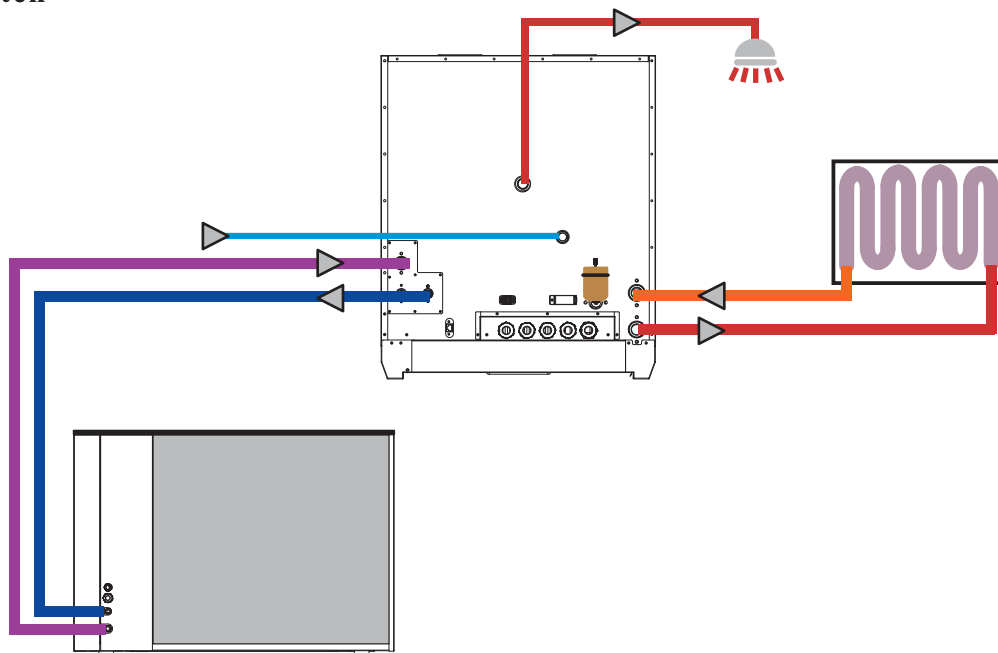

# 2. Introduction

## 2.4. Product Components Diagram

Below is a general system application of the heat pump. Any specific configurations should be a variation of this “master” system drawing. All suggested assembly variations are given in Chapter 3.

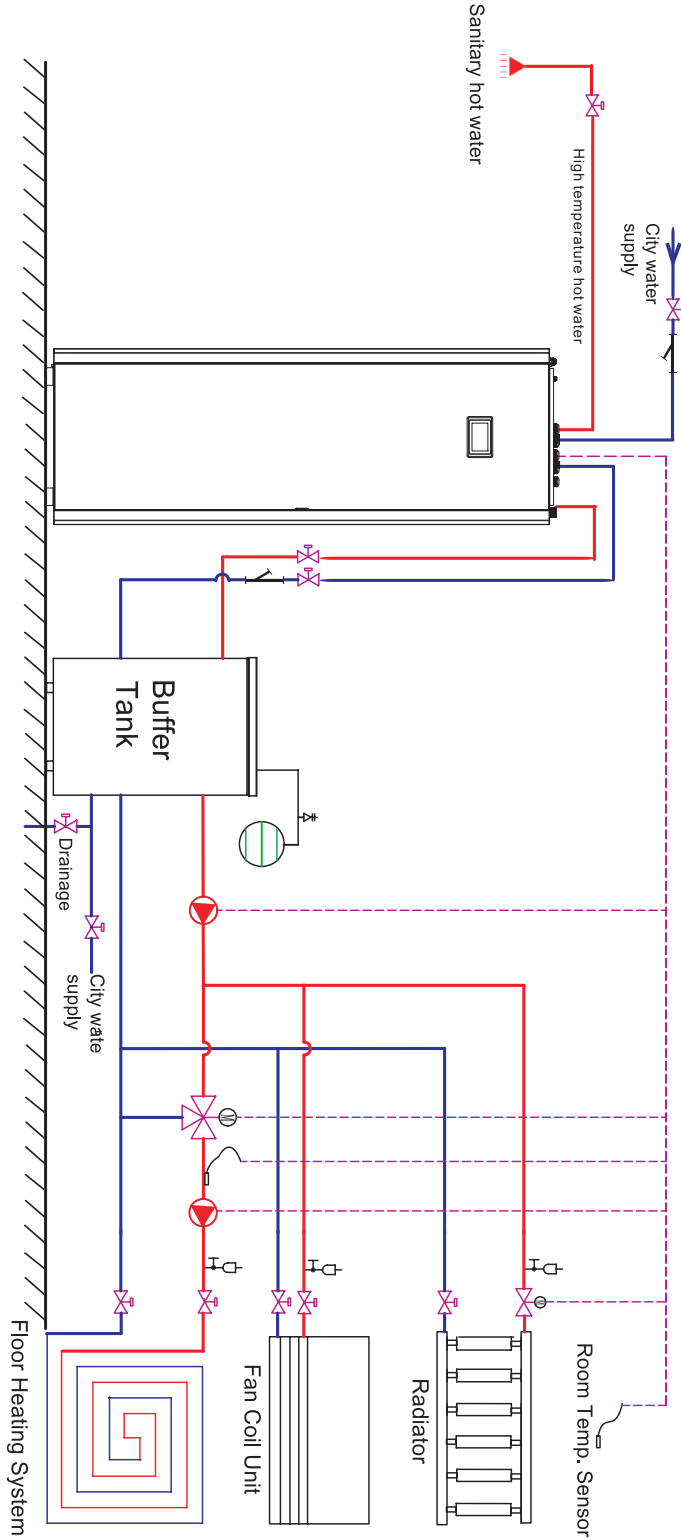

Name	Symbol	Name	Symbol
Temp. Sensor		Water pump	
Safety valve Kit		Mixing valve	
Ball valve		Motorized valve	
Water filter		Expansion tank	
Air purging valve			

Note: Dotted lines mean “able to be controlled by the Heat Pump” .

## 2. Introduction

### 2.5. Technical Specifications

Model	Outdoor unit		AW6-R32-S-V8	AW9-R32-S-V8	AW12-R32-S-V8
IP rating		IPXX	IP44	IP44	IP44
Indoor unit tank version					
Model	Indoor unit tank version		AWST6/12-R32-S-V8		
IP rating		IPXX	IP34		
Min/max heating capacity(1)		kW	3.5/6.5	4.3/9.2	5.5/11.6
El. heating power input min/max(1)		W	750/1410	920/2090	1100/2680
C.O.P min/max(1)		W/W	4.5/4.7	4.38/4.71	4.3/4.9
Min/max heating capacity(2)		kW	2.3/5.9	3.9/8.6	4.9/11.2
El. heating power input min/max(2)		W	909/1917	1120/2510	1401/3263
C.O.P min/max(2)		W/W	2.6/3.1	3.46/3.66	3.4/3.6
SCOP - Average climate, low temperature		W	4.72	4.72	4.71
Energy class			A+++	A+++	A+++
Min/max cooling capacity(3)		kW	6.22/7.41	8.48/9.5	7.0/9.8
El. cooling power input min/max(3)		W	1374/1806	1860/2200	1728/2510
E.E.R. min/max(3)		W/W	4.1/4.5	4.31/4.56	3.9/4.05
Min/max cooling capacity(4) (A35/W7)		kW	3.5/4.5	4.9/7.2	4.9/8.5
El. cooling power input min/max(4)		W	1330/1680	1450/2360	1350/2440
E.E.R. min/max(4)		W/W	2.5/2.74	2.8/3.1	2.6/3.5
Min/max ambient working temp. in heating mode		°C	-30~45		
Min/max ambient working temp. in cooling mode		°C	8~65		
Max flow temp. in heating mode		°C	58		
Min flow temp. in heating mode		°C	20		
Min flow temp. in cooling mode		°C	7		
Defrost upon demand			yes		
Heating cable for defrosting			yes		
Compressor pre-heat			yes		
Electronic expansion valve			yes		
Max. Operation High Pressure		bar	42		
Min. Operation Low Pressure		bar	14		
PS Hydraulics circuit		bar	3		
Min. Floor Area for installation, operation and storage		m <sup>2</sup>	3.1		
Min. Area Pipe-work		m <sup>2</sup>	3.1		
DHW tank indoor unit data					
DHW tank volume neto	Indoor unit tank version	L	250		
DHW tank tube exchanger length	Indoor unit tank version	m	30		
DHW tank tube exchanger diameter	Indoor unit tank version	mm	28		
El. heater for heating water ( flow)	Indoor unit tank version	kW	9 ( 3 X 3)		
Expansions vessel 1 upper one	Heating water tank version	L	5		
Expansions vessel 2 lower one	Heating water tank version	L	5		
DHW tank piping connection	Piping connection heating water	Inch	G1"		
	Piping connection city water	Inch	G3/4"		

## 2. Introduction

			AW6-R32-S-V8	AW9-R32-S-V8	AW12-R32-S-V8
Model					
ErP approved circulation pump	Manufacturer		Shimge		
	type		APM25-9-130/180 PWM1		
	ErP classification		EEI≤0.21-Part3		
Compressor	Manufacturer		Mitsubishi		
	type		DC inverter (twin rotary)		
Fan	Quantity	pcs	1	1	1
	Airflow	m³/h	2500	3150	3150
	Rated power	W	35	45	45
	Blade diameter	mm	φ496	φ550	φ550
	Fan rotation	Direction	counter-clockwise	counter-clockwise	counter-clockwise
Sound power level	Outdoor unit	dB (A)	52	53	52
	Indoor unit tank version	dB (A)	44	45	45
Plate heat exchanger	Manufacturer		SWEP		
	Water press. drop	kPa	26	26	26
	Piping connection	Inch	G1"	G1"	G1"
Minimum water flow for triggering the flow switch		m³/h - l/s	0.75/0.21	0.94/0.26	1.44/0.40
Nominal water flow		m³/h	1.04	1.55	2.05
Residual current device and overvoltage protection			Required		
Power supply (grounded) Outdoor unit	Outdoor unit	V/N/Hz	230/1/50	230/1/50	230/1/50
	Fuse Outdoor unit	A	10A/C	16A/C	16A/C
Power supply (grounded) Indoor unit tank version	Indoor unit tank version	V/N/Hz	400/3/50 or 230/1/50 or 230/3/50		
	Fuse Indoor unit tank version	A	16A/C-400V or 40A/C-230V or 25A/C-230V		
Refrigerant	type		R 32		
	charge	kg	1	1.6	1.8
	GWP (global warming potential)	GWP	GWP: 675	GWP: 675	GWP: 675
	Quantity of hydrofluorocarbons in tonnes of CO2 equivalent	t CO <sub>2</sub> Equiv.	0.675	1.08	1.215
Dimensions net (L x D x H)	Outdoor unit	mm	1025x397x748	1207x412x898	1207x412x898
	Indoor unit tank version	mm	707 x 600 x 1720		
Dimensions Brutto (L x D x H) including carton box and palette	Outdoor unit	mm	1085x500x920	1270x510x1055	1270x510x1055
	Indoor unit tank version	mm	785 x 670 x 1920		
Net weight	Outdoor unit	kg	70	85	92
	Indoor unit tank version	kg	140		
Brutto weight including carton box, added manuals, sensors and palette	Outdoor unit	kg	85	104	111
	Indoor unit tank version	kg	160		

- (1) Heating condition: water inlet/outlet temperature: 30 °C/35°C, Ambient temperature: DB 7 °C /WB 6 °C
- (2) Heating condition: water inlet/outlet temperature: 40°C/45°C, Ambient temperature: DB 7 °C /WB 6 °C
- (3) Cooling condition: water inlet/outlet temperature: 23 °C/18°C, Ambient temperature: DB 35 °C /WB 24 °C
- (4) Cooling condition: water inlet/outlet temperature: 12°C/7°C, Ambient temperature: DB 35 °C /WB 24 °C

# 3. Overview of the Units

## 3.1. Functional Diagrams

【 Split indoor unit 】

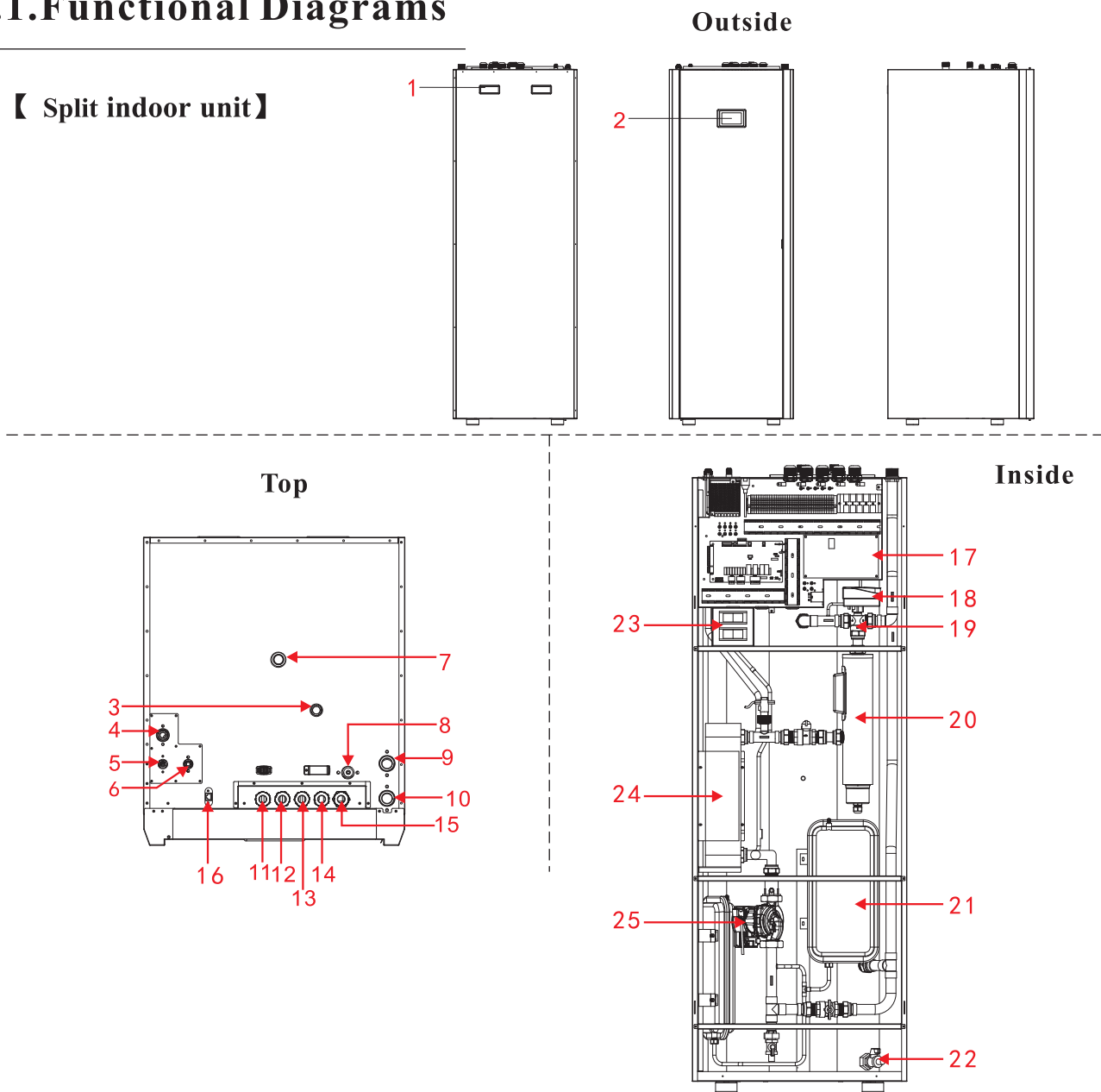

NO.	Name	NO.	Name
1	Handle	16	LAN connector
2	Touch screen operation panel	17	Electric box
3	Cold sanitary water (G3/4")	18	Three-way valve coil
4	Refrigerant connector (5/8")	19	Three-way valve
5	Service valve 1/2-UNF	20	9KW Electric heater
6	Refrigerant connector (3/8")	21	Buffer tank
7	Hot sanitary water (G1")	22	Drainage
8	Automatic air vent	23	Digital thermostat
9	Heating / cooling return line (G1")	24	Plate heat exchanger
10	Heating / cooling flow line (G1")	25	Water pump
11-15	Cable gland		

# 3. Overview of the Units

## 3.1. Functional Diagrams

### 【 Split indoor unit 】

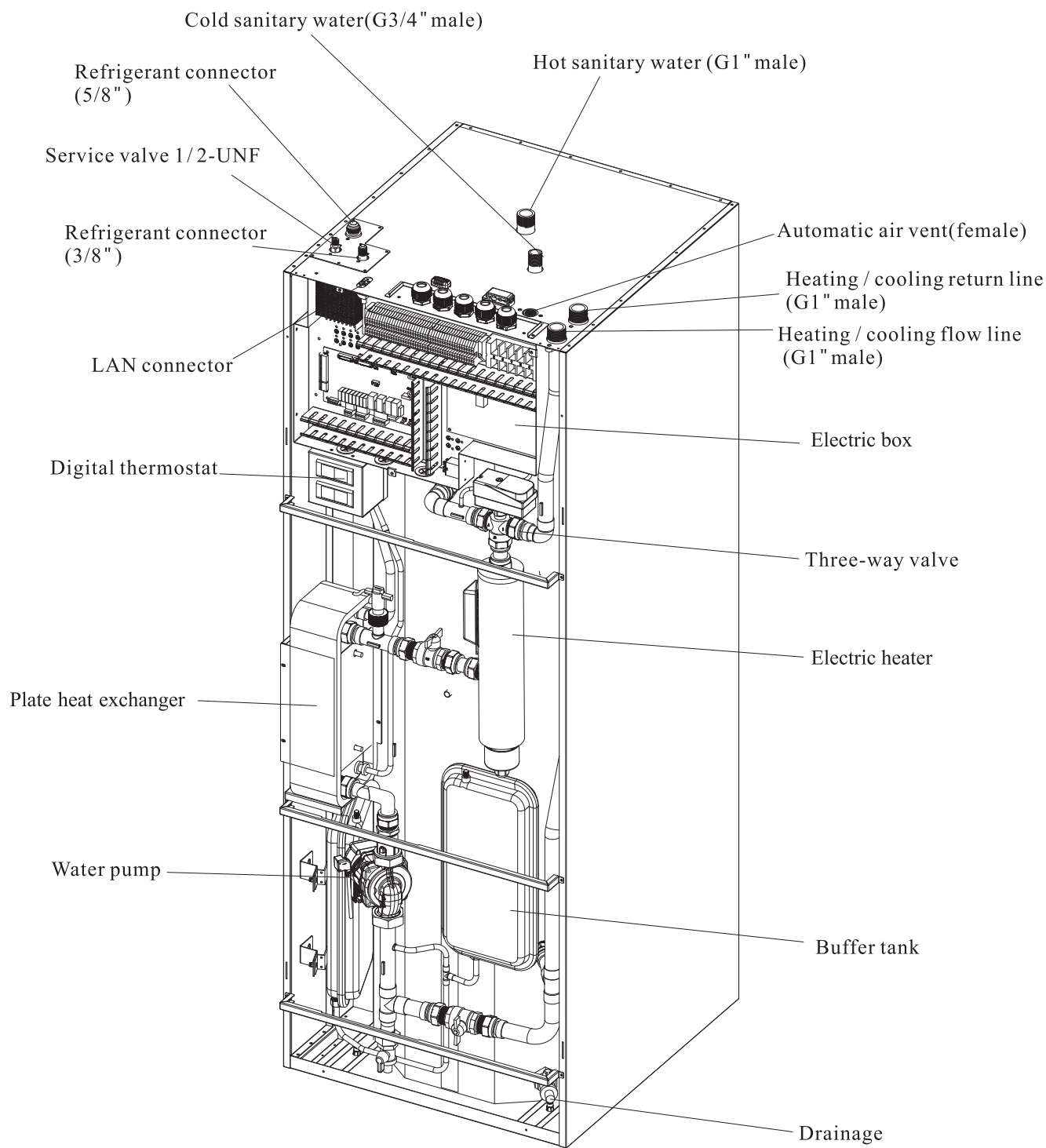



# 3. Overview of the Units

## 3.2.Outlines and Dimensions

【 Split indoor unit 】

Unit:mm

AWST6/12-R32-S-V8

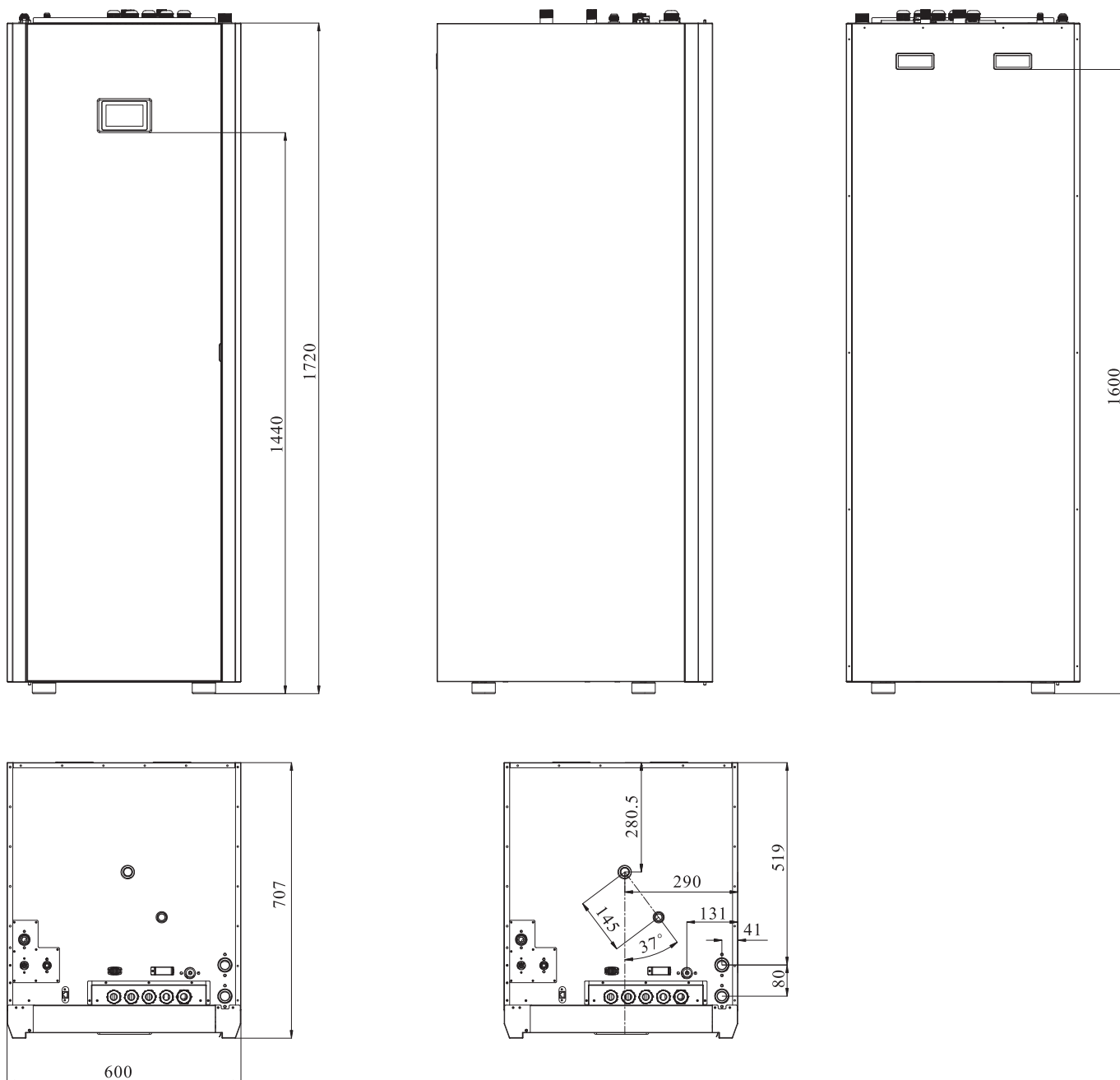

# 3. Overview of the Units

## 3.2.Outlines and Dimensions

【 Split outdoor unit 】

AW6-R32-S-V8

Unit:mm

Liquid pipe O.D:  $\phi 6.35(1/4")$

Gas pipe O.D:  $\phi 12.7(1/2")$

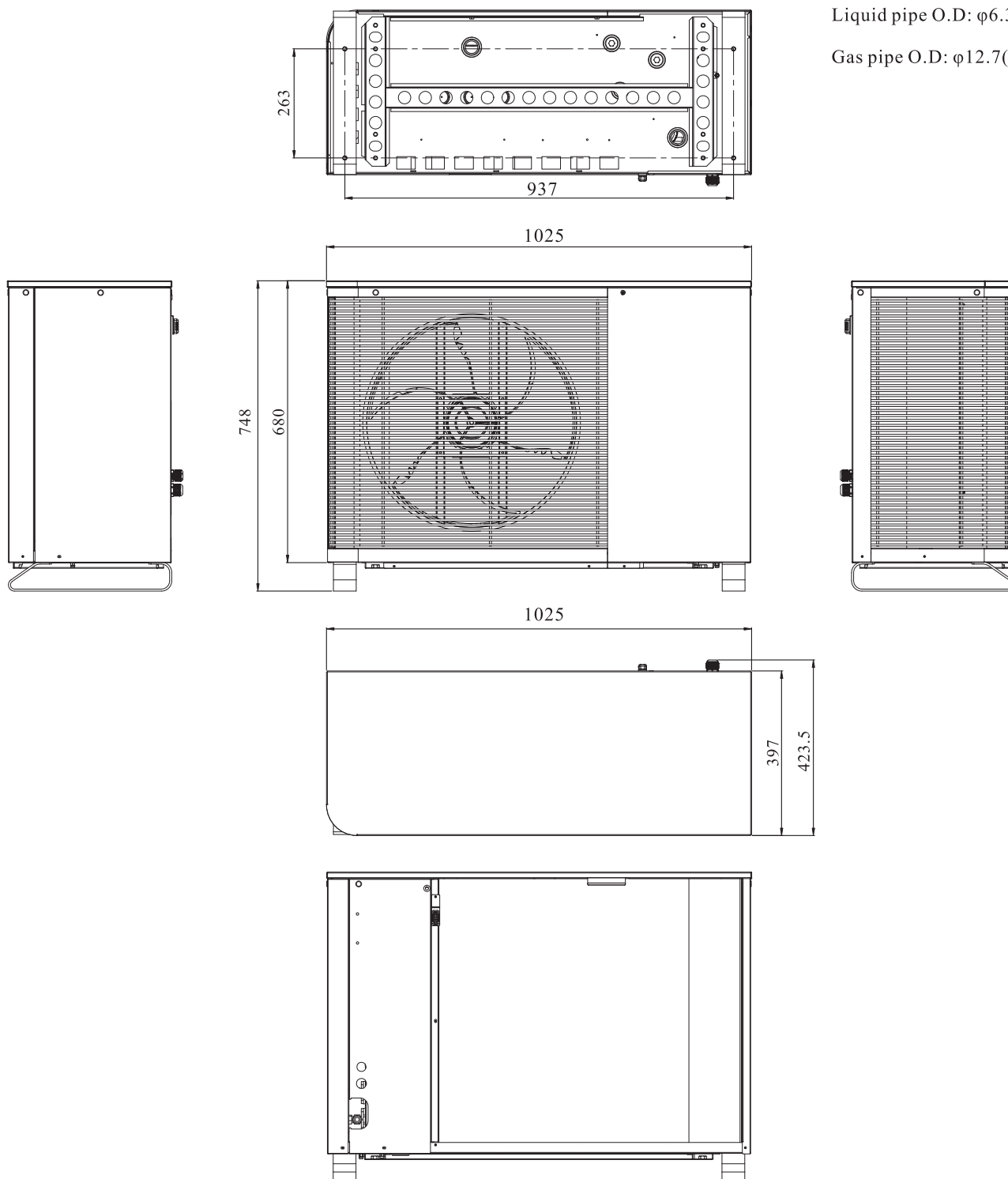

# 3. Overview of the Units

## 3.2.Outlines and Dimensions

### 【 Split outdoor unit 】

AW9-R32-S-V8

AW12-R32-S-V8

Unit:mm

Liquid pipe O.D:  $\phi 9.52(3/8")$

Gas pipe O.D:  $\phi 15.88(5/8")$

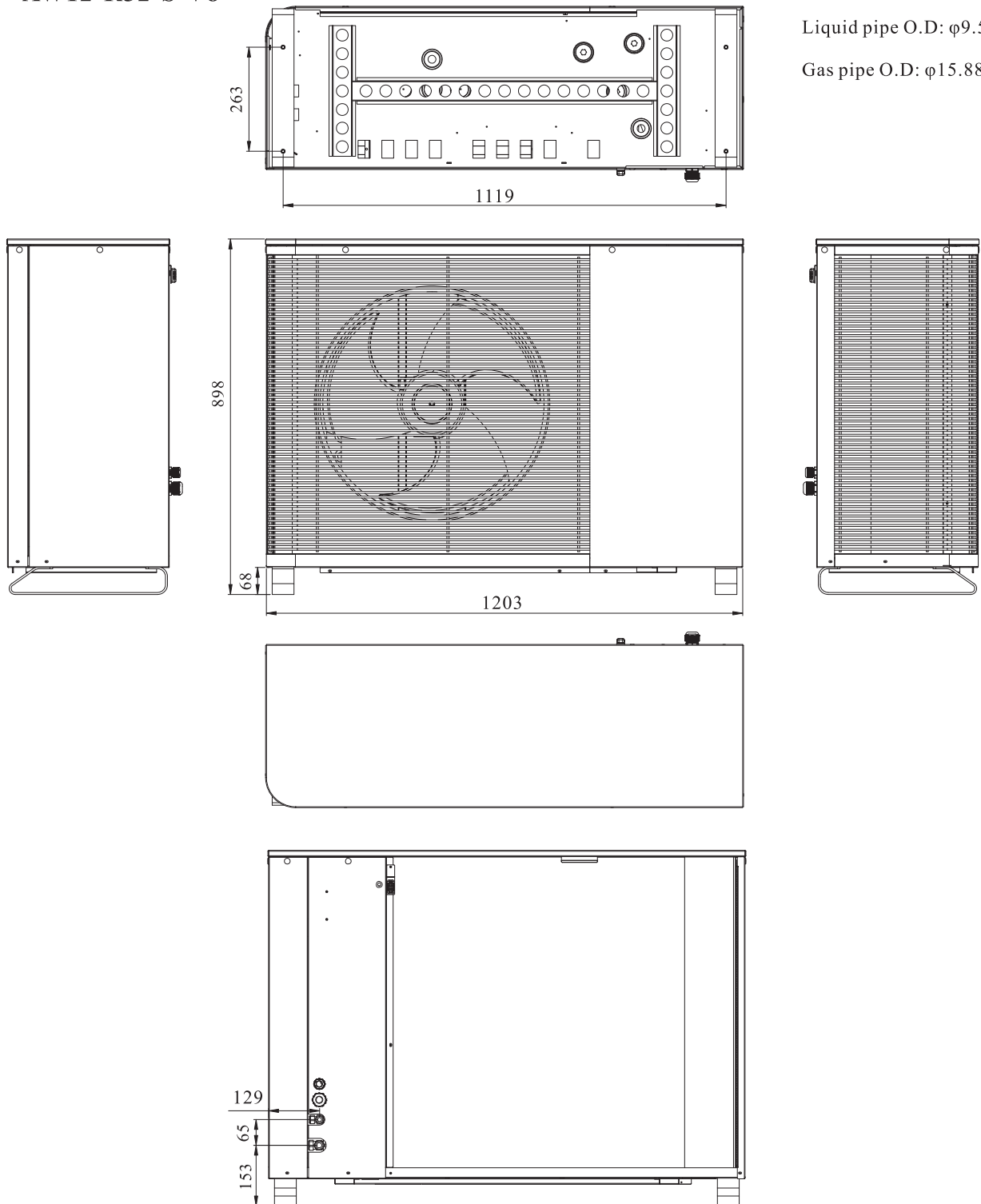

# 3. Overview of the Units

## 3.3. Exploded view

Split outdoor unit:  
AW6/9/12-R32-S-V8

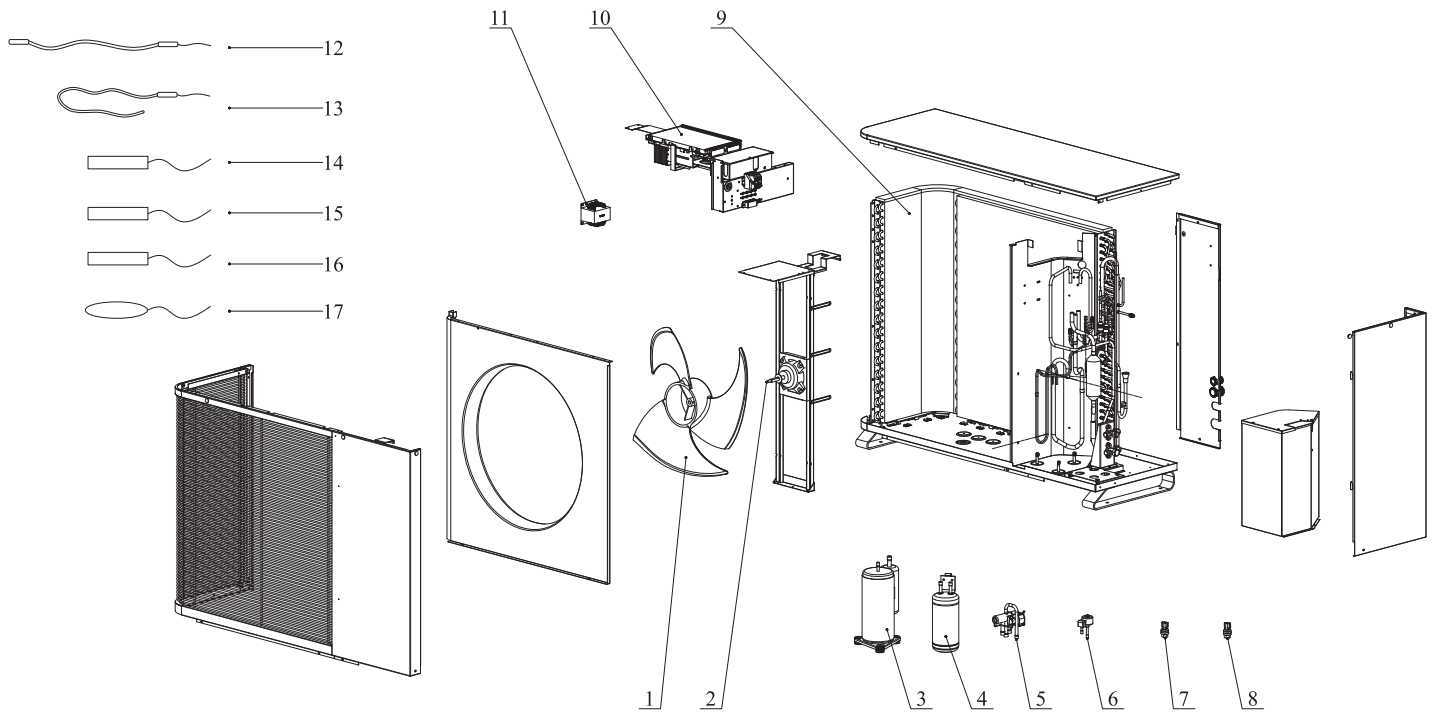

NO	Name	NO	Name
1	Fan	8	Low pressor sensor
2	Fan motor	9	Evaporater
3	Compressor	10	Main PCB
4	Liquid receiver	11	Reactor
5	Four-way valve	12	Bottom plate heater
	Four-way valve coil	13	Compressor heater
6	EEV	14	Discharge temp. sensor
	EEV coil	15-17	Suction/Coil/Ambient temp. sensor
7	High pressor sensor		

# 4. Assembly Configurations - Flowchart

## Locate the Configuration that Meets Your Needs

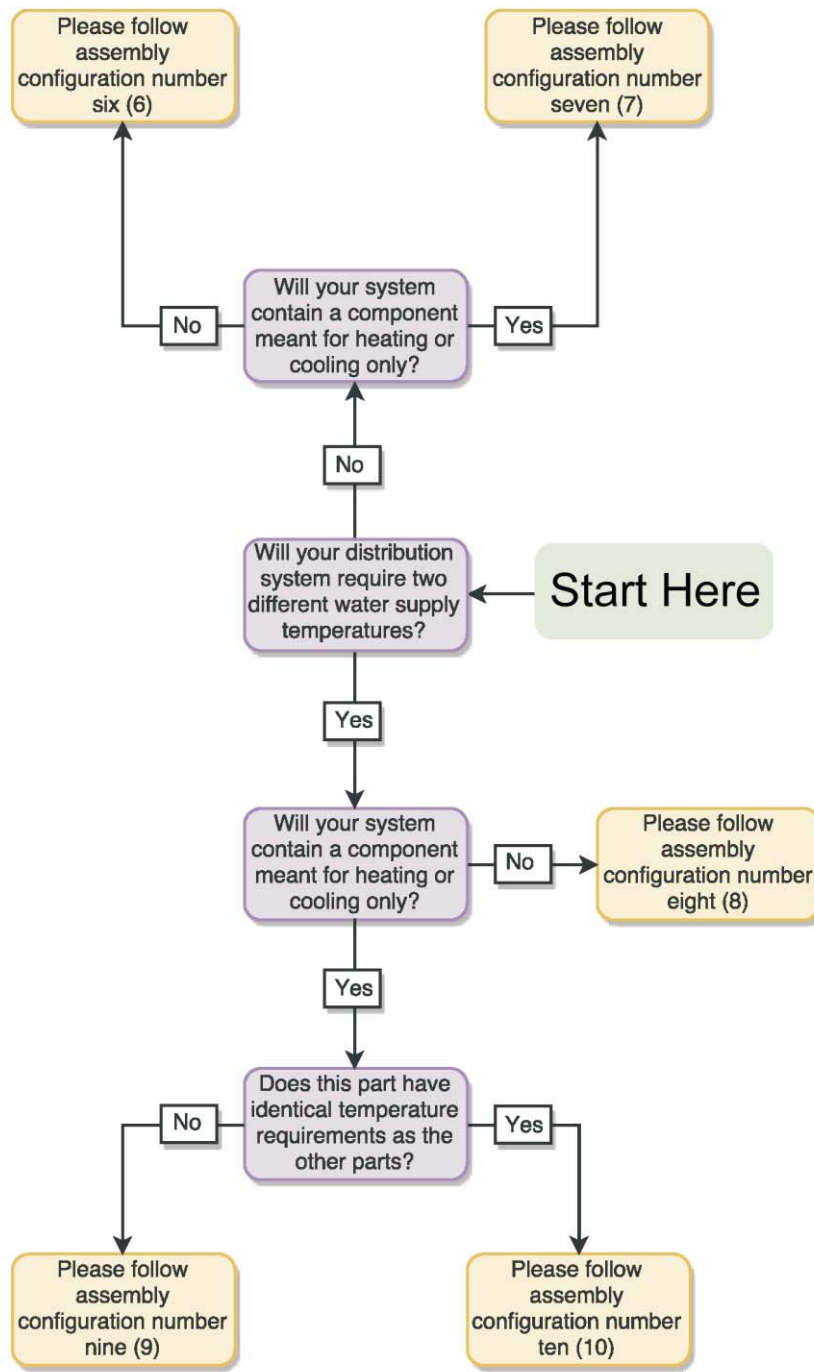

Follow the flowchart on the right in order to locate which of the assembly configuration matches the needs of the end user, each of which contains specific assembly and wiring diagrams, with software instructions.

Beginning from the green “Start Here” bubble, follow the appropriate arrows to each question, which are dependent on the needs of the user.

The corresponding assembly instructions will be found by turning to the page number in the end bubble.

**Note:** *The instructions in this section are meant to achieve the minimum requirements for successful system operation only.*

*For more in-depth settings explanations, please refer to the user’s manual.*

# 4. Assembly Configurations – Drawing 1

Please ensure that the configuration matches the assembly drawing depicted on the right for a one temperature zone setup that includes domestic hot water.

*Note: Refer to the next page for wiring and software operation instructions.*

Name	Symbol	Name	Symbol
Temp. Sensor		Water pump	
Safety valve Kit		Expansion tank	
Ball valve			
Water filter			
Air purging valve			

*Note: Dotted lines mean "able to be controlled by the Heat Pump". distribution systems.*

*Notice: The Fan Coil Unit, Floor Heating System, and Radiator are placeholder distribution systems only and can be substituted by any other appropriate distribution systems.*

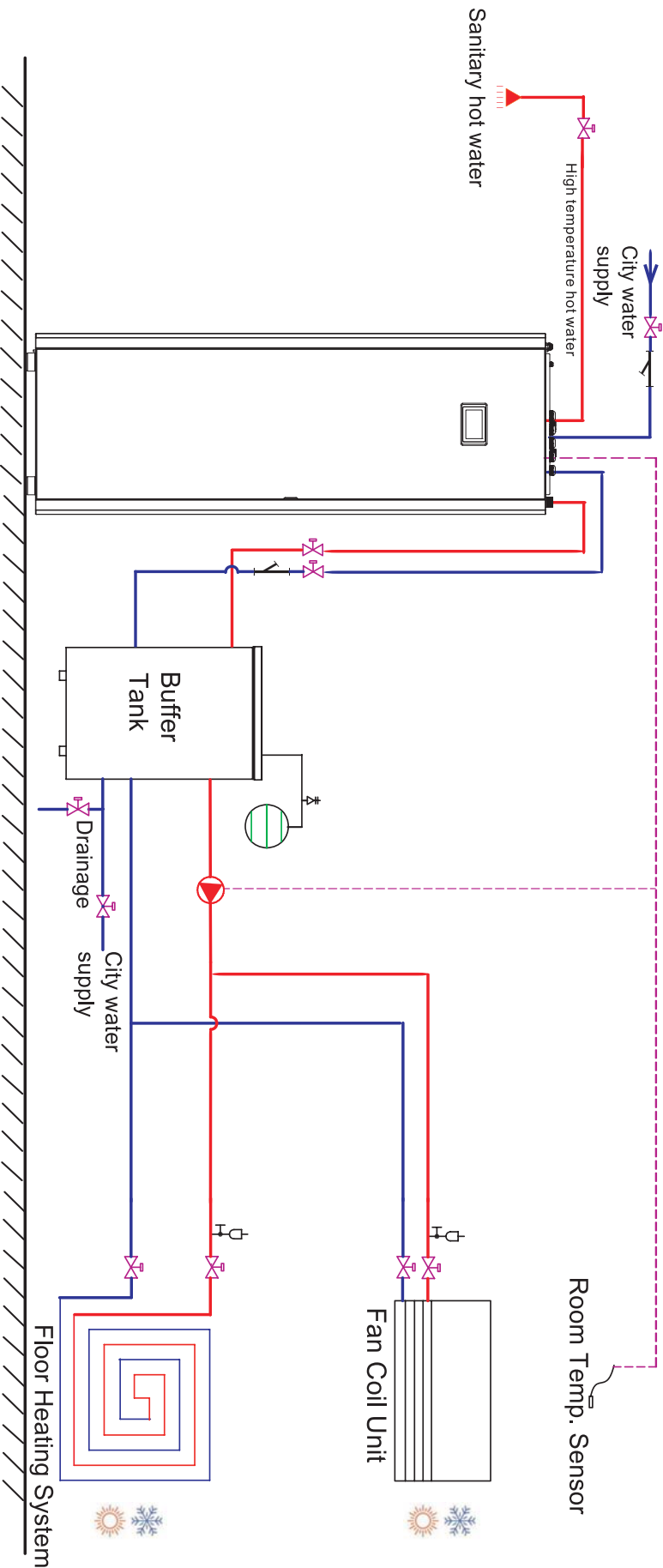

One Temperature Zone, without DHW

# 4. Assembly Configurations – Drawing 1

## Assembly 1: Wiring Diagram

To achieve successful operation at a minimum, ensure the ports below are properly connected.

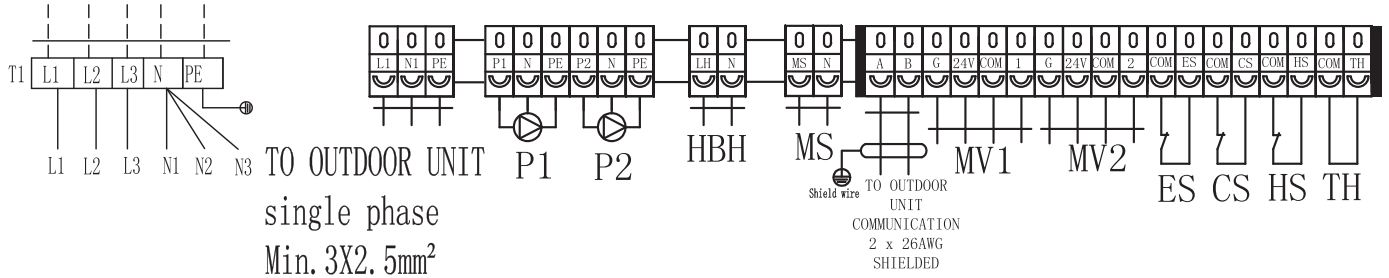

## Software: Basic Settings

1. Set the needed working modes of the unit via the menu

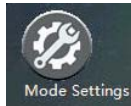

2. Temperature configuration options for Heating/Cooling circuit 1 are found under



H. Configuring the set water heating temperatures:

H.1. Setting a heating curve:



Ambient Temp. 1	-25°C
Ambient Temp. 2	-15°C
Ambient Temp. 3	-5°C
Ambient Temp. 4	5°C
Ambient Temp. 5	10°C

Water Temp. A/Ambient Temp. 1	40°C
Water Temp. B/Ambient Temp. 2	37°C
Water Temp. C/Ambient Temp. 3	33°C
Water Temp. D/Ambient Temp. 4	29°C
Water Temp. E/Ambient Temp. 5	25°C

H.2. If no heating curve is desired:

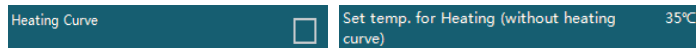

C. Configuring the set water cooling temperature (if applicable):

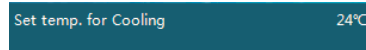

If cooling function is desired, ensure these sections are configured.

3. Locate and activate the buffer tank and appropriate pumps under

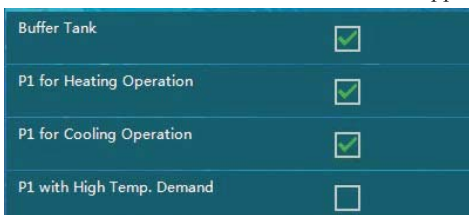

## 4. Assembly Configurations – Drawing 1

---

### Software: Basic Settings (continued)

4. Double-check to ensure that the Domestic Hot Water option is enabled under



5. Configure the desired setpoint for water temperature (default set to 50°C):





# 4. Assembly Configurations – Drawing 2

Please ensure that the configuration matches the assembly drawing depicted on the right for a one temperature zone setup that includes domestic hot water; that also includes a component circuit capable of heating or cooling only, through the use of a two-way motorized valve.

Note: For the cooling-only or heating-only circuit, a motorized two-way valve can be connected to the unit, to cut the water supply during heating or cooling operation.

Refer to the next page for wiring and software operation instructions.

Name	Symbol	Name	Symbol
Temp. Sensor		Water pump	
Safety valve Kit		Motorized valve	
Ball valve		Expansion tank	
Water filter			
Air purging valve			

Notice: The Fan Coil Unit, Floor Heating System, and Radiator are placeholder distribution systems only and can be substituted by any other appropriate distribution systems.

Note: Dotted lines mean "able to be controlled by the Heat Pump".

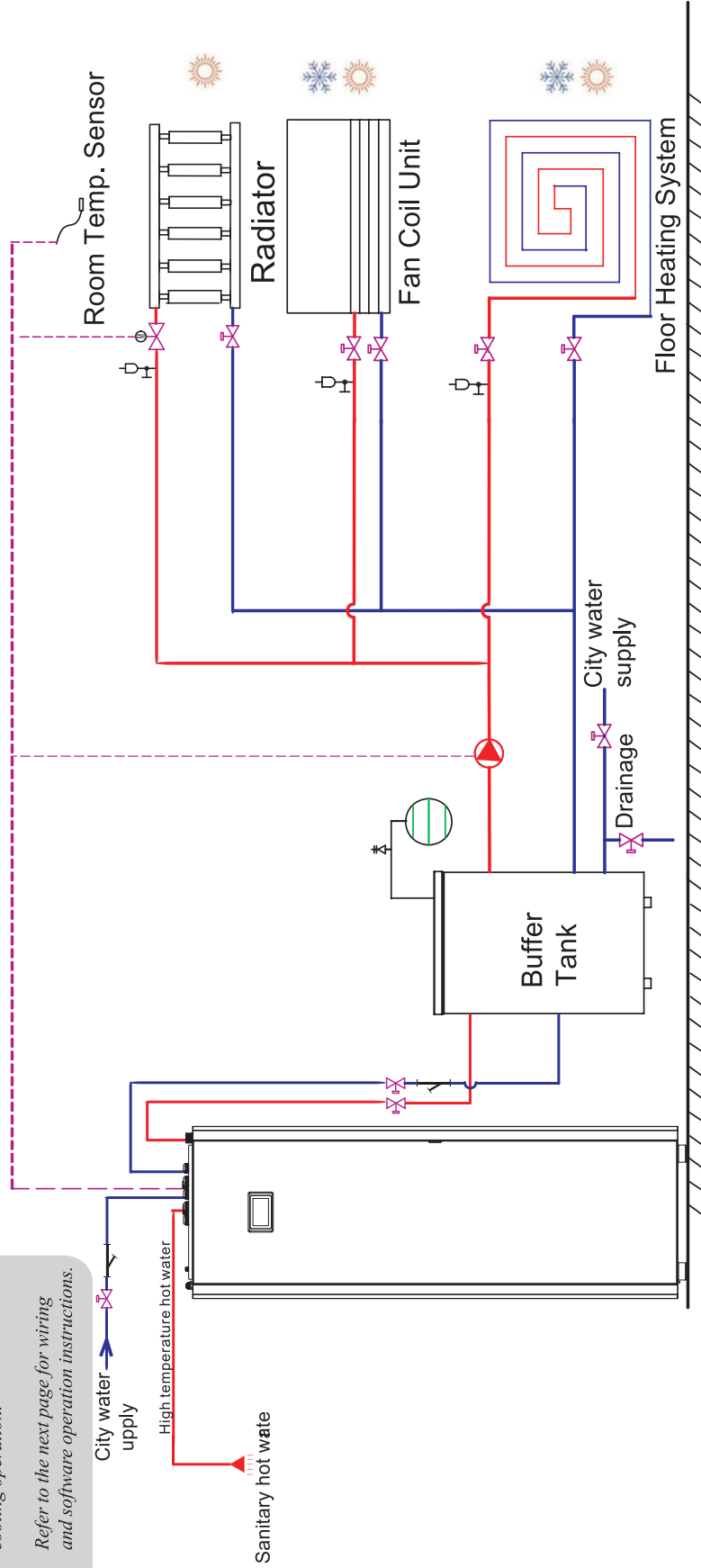

One Temperature Zone, without DHW, with a heating-only (or cooling-only) circuit, by usage of a motorized 2-way valve

# 4. Assembly Configurations – Drawing 2

## Assembly 2: Wiring Diagram

To achieve successful operation at a minimum, ensure the ports below are properly connected.

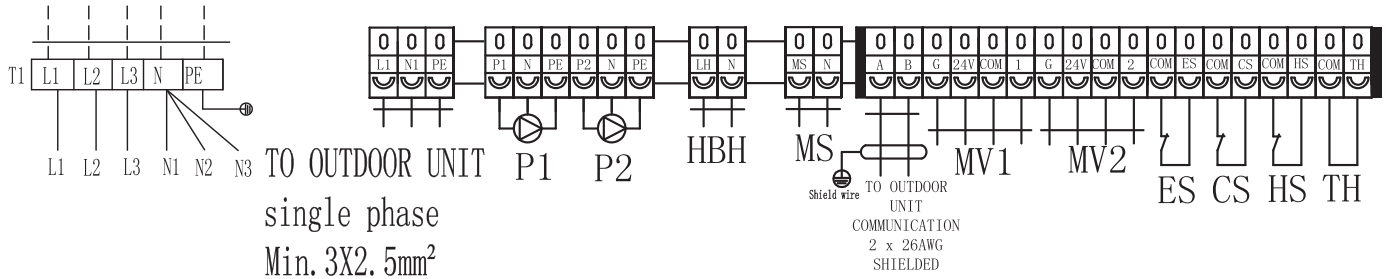

## Software: Basic Settings

1. Set the needed working modes of the unit via the menu

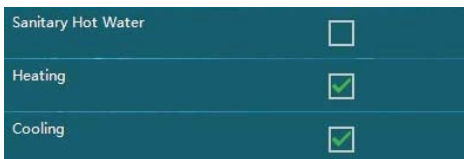
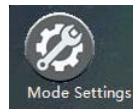

2. Temperature configuration options for Heating/Cooling circuit 1 are found under



**H.** Configuring the set water heating temperatures:

**H.1.** Setting a heating curve:



Ambient Temp. 1	-25°C
Ambient Temp. 2	-15°C
Ambient Temp. 3	-5°C
Ambient Temp. 4	5°C
Ambient Temp. 5	10°C

Water Temp. A/Ambient Temp. 1	40°C
Water Temp. B/Ambient Temp. 2	37°C
Water Temp. C/Ambient Temp. 3	33°C
Water Temp. D/Ambient Temp. 4	29°C
Water Temp. E/Ambient Temp. 5	25°C

**H.2.** If no heating curve is desired:

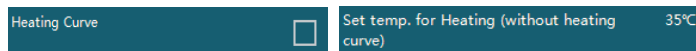

**C.** Configuring the set water cooling temperature (if applicable):

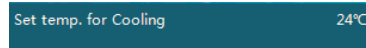

If cooling function is desired, ensure these sections are configured.

3. Locate and activate the buffer tank and appropriate pumps under

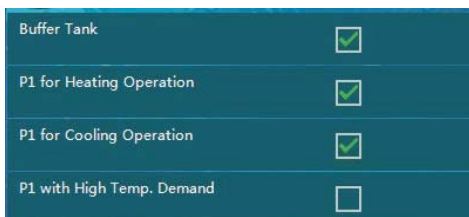
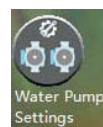

## 4. Assembly Configurations – Drawing 2

### Software: Basic Settings (continued)

4. The location of the configuration for heating-only or cooling-only system is under

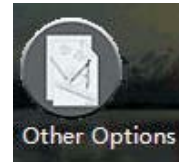

5. Double-check to ensure that the Domestic Hot Water option is enabled under

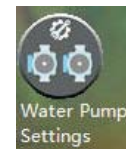

6. Configure the desired setpoint for water temperature (default set to 50°C):



# 4. Assembly Configurations – Drawing 3

Please ensure that the configuration matches the assembly drawing depicted on the right for a two temperature zone setup that includes domestic hot water.

*Note: Refer to the next page for wiring and software operation instructions.*

Name	Symbol	Name	Symbol
Temp. Sensor		Water pump	
Safety valve Kit		Mixing valve	
Ball valve		Expansion tank	
Water filter			
Air purging valve			

*Note: Dotted lines mean "able to be controlled by the Heat Pump".*

*Notice: The Fan Coil Unit, Floor Heating System, and Radiator are placeholder distribution systems only and can be substituted by any other appropriate distribution systems.*

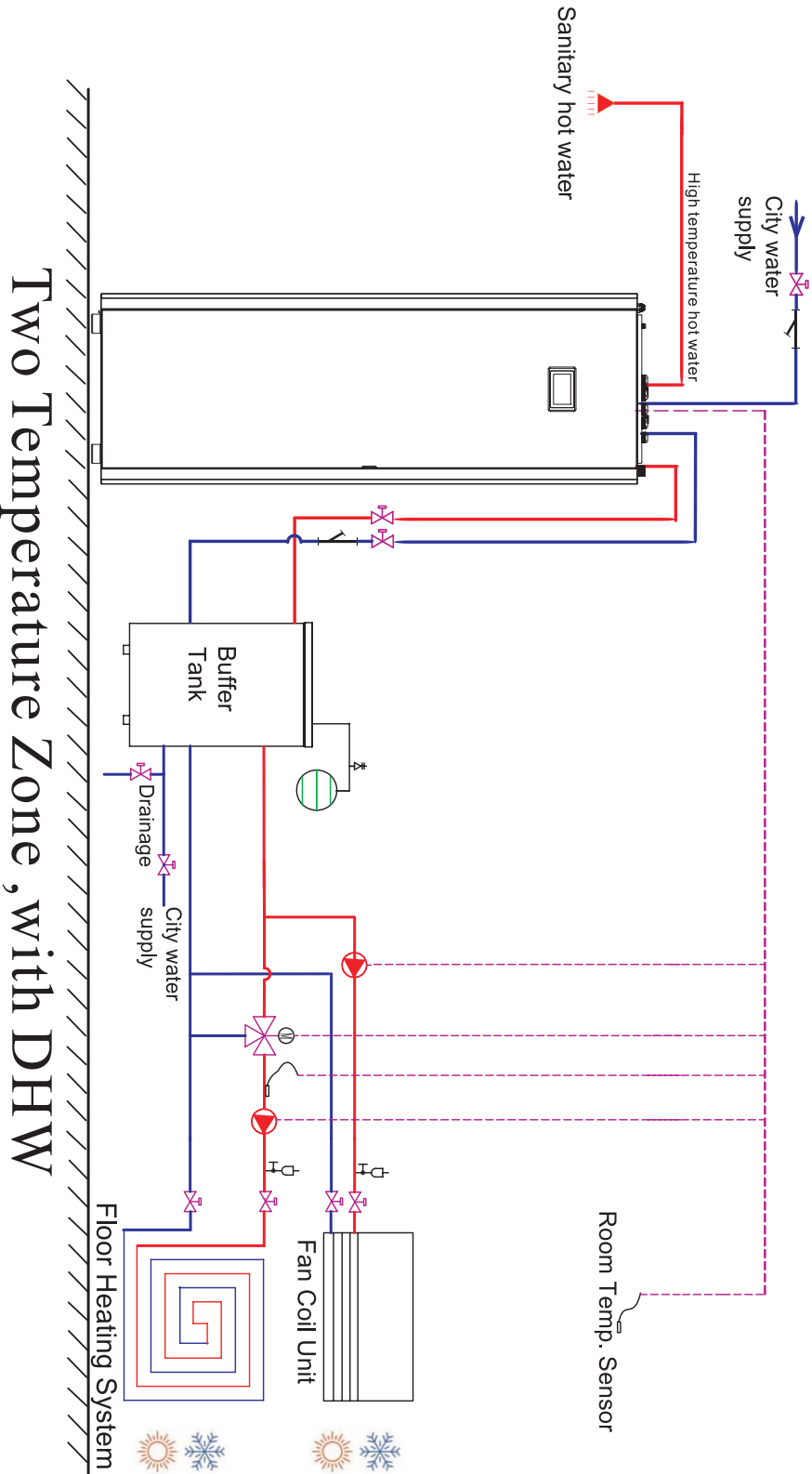

Two Temperature Zone, with DHW

# 4. Assembly Configurations – Drawing 3

## Assembly 3: Wiring Diagram

To achieve successful operation at a minimum, ensure the ports below are properly connected.

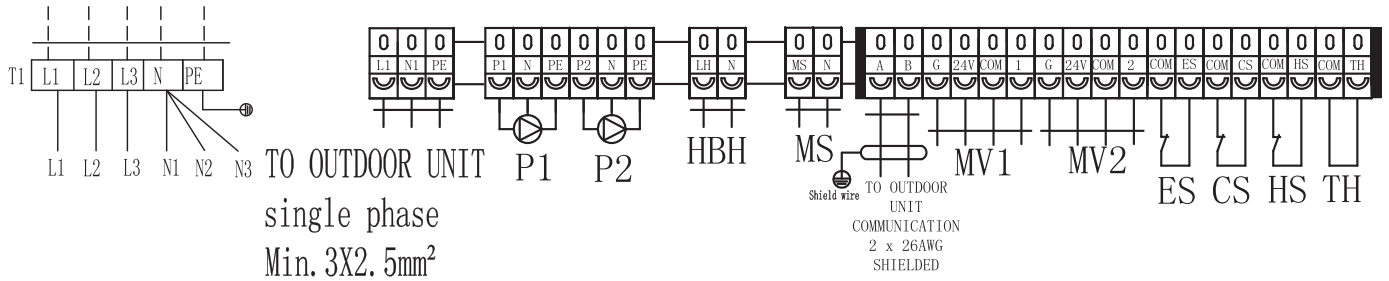

For connection for mixing valve 2, please refer to the appendix A (on page 68-69) of this manual for more information.

## Software: Basic Settings

1. Set the needed working modes of the unit via the menu

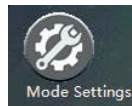

Sanitary Hot Water	<input type="checkbox"/>
Heating	<input checked="" type="checkbox"/>
Cooling	<input checked="" type="checkbox"/>

2. Temperature configuration options for Heating/Cooling circuit 1 are found under



H. Configuring the set water heating temperatures:

H.1. Setting a heating curve:

Heating Curve	<input checked="" type="checkbox"/>
---------------	-------------------------------------

Ambient Temp. 1	-25°C
Ambient Temp. 2	-15°C
Ambient Temp. 3	-5°C
Ambient Temp. 4	5°C
Ambient Temp. 5	10°C

Water Temp. A/Ambient Temp. 1	40°C
Water Temp. B/Ambient Temp. 2	37°C
Water Temp. C/Ambient Temp. 3	33°C
Water Temp. D/Ambient Temp. 4	29°C
Water Temp. E/Ambient Temp. 5	25°C

H.2. If no heating curve is desired:

Heating Curve	<input type="checkbox"/>	Set temp. for Heating (without heating curve)	35°C
---------------	--------------------------	-----------------------------------------------	------

C. Configuring the set water cooling temperature (if applicable):

Set temp. for Cooling	24°C
-----------------------	------

If cooling function is desired, ensure these sections are configured.

3. Locate and activate the buffer tank and appropriate pumps under



Buffer Tank	<input checked="" type="checkbox"/>
P1 for Heating Operation	<input checked="" type="checkbox"/>
P1 for Cooling Operation	<input checked="" type="checkbox"/>
P1 with High Temp. Demand	<input type="checkbox"/>

# 4. Assembly Configurations – Drawing 3

## Software: Basic Settings (continued)

3.(cont.) Configure the water pump to operate for heating or cooling:

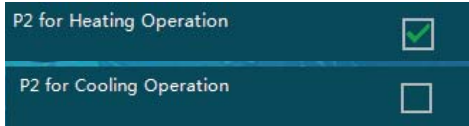

4. Temperature configuration options for Heating/Cooling circuit 2 are found under

Please activate entire Heating/Cooling circuit 2 setting



H. configuring the set water heating temperatures:



H.1. Setting a heating curve:



Water Temp. A/Ambient Temp. 1	40°C
Water Temp. B/Ambient Temp. 2	37°C
Water Temp. C/Ambient Temp. 3	33°C
Water Temp. D/Ambient Temp. 4	29°C
Water Temp. E/Ambient Temp. 5	25°C

H.2. If no heating curve is desired:

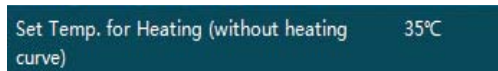

C. Configuring the set water cooling temperature (if applicable):



4.1. Activate the mixing valve to manage the second circuit:



*Note: This pair of settings will interpret “Heating/Cooling Circuit 2 as the low demand distribution system, requiring a lower set temperature for heating and higher set temperature for cooling.*

5. Double-check to ensure that the Domestic Hot Water option is enabled under

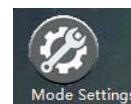

6. Configure the desired setpoint for water temperature (default set to 50°C):



Dependent on whether cooling is needed

# 4. Assembly Configurations – Drawing 4

Please ensure that the configuration matches the assembly drawing depicted on the right for a two temperature zone setup that includes domestic hot water, also that includes a component circuit capable of heating or cooling only, through the use of a two-way motorized valve.

*Note: For the cooling-only or heating-only circuit, a motorized two-way valve can be connected to the unit, to cut the water supply during heating or cooling operation.*

*Refer to the next page for wiring and software operation instructions.*

*Notice: The Fan Coil Unit, Floor Heating System, and Radiator are placeholder distribution systems only and can be substituted by any other appropriate distribution systems.*

Name	Symbol	Name	Symbol
Temp. Sensor		Water pump	
Safety valve Kit		Mixing valve	
Ball valve		Motorized valve	
Water filter		Expansion tank	
Air purging valve			

Note: Dotted lines mean "able to be controlled by the Heat Pump".

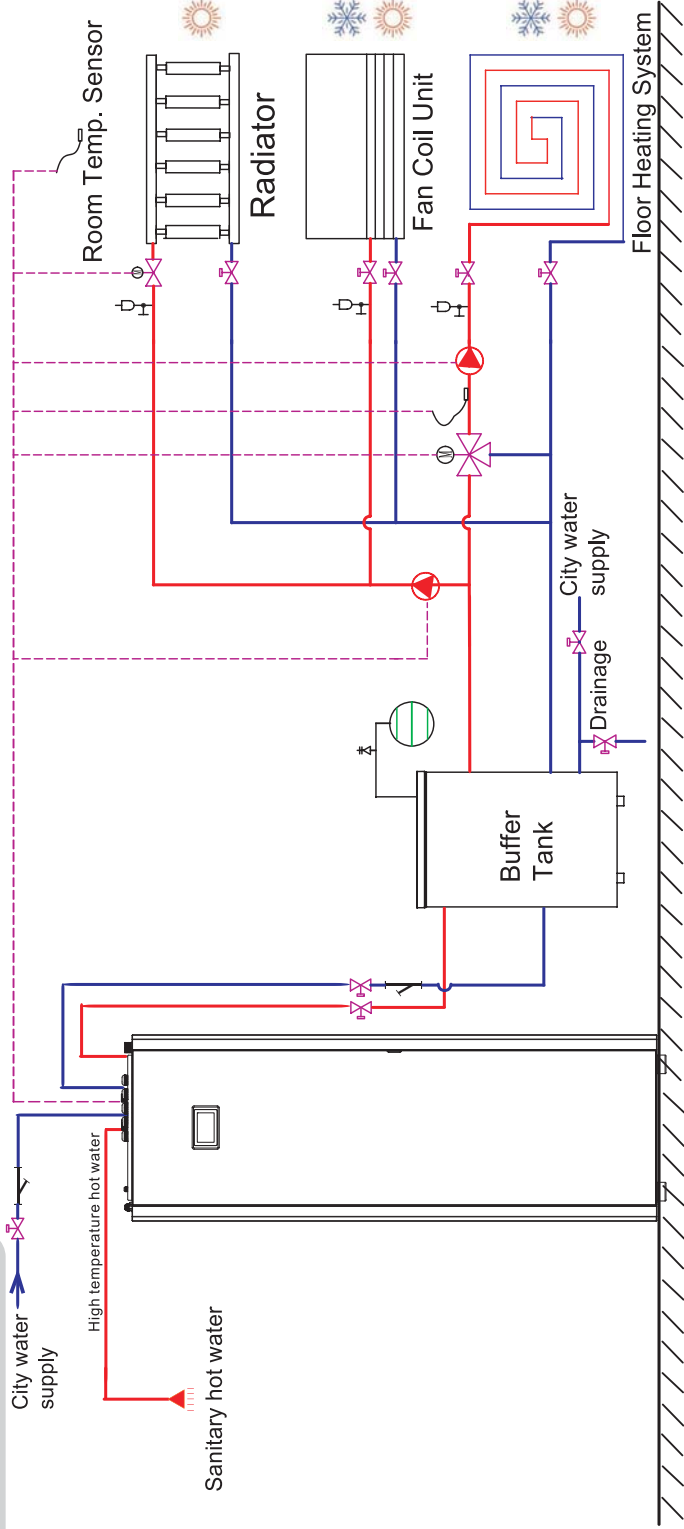

Two Temperature Zones , without DHW, with a heating-only (or cooling-only) circuit, by usage of a motorized 2-way valve



# 4. Assembly Configurations – Drawing 4

## Assembly 4: Wiring Diagram

To achieve successful operation at a minimum, ensure the ports below are properly connected.

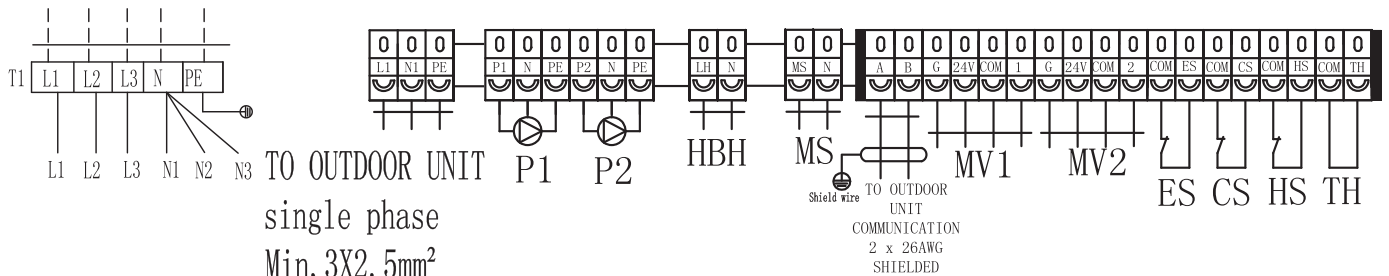

For connection for mixing valve 2, please refer to the appendix A (on page 68-69) of this manual for more information.

## Software: Basic Settings

1. Set the needed working modes of the unit via the menu

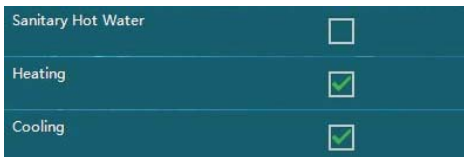
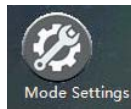

2. Temperature configuration options for Heating/Cooling circuit 1 are found under



**H.** Configuring the set water heating temperatures:

**H.1.** Setting a heating curve:



Ambient Temp. 1	-25°C
Ambient Temp. 2	-15°C
Ambient Temp. 3	-5°C
Ambient Temp. 4	5°C
Ambient Temp. 5	10°C

Water Temp. A/Ambient Temp. 1	40°C
Water Temp. B/Ambient Temp. 2	37°C
Water Temp. C/Ambient Temp. 3	33°C
Water Temp. D/Ambient Temp. 4	29°C
Water Temp. E/Ambient Temp. 5	25°C

**H.2.** If no heating curve is desired:

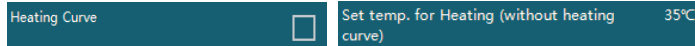

**C.** Configuring the set water cooling temperature (if applicable):

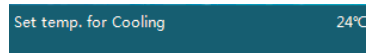

If cooling function is desired, ensure these sections are configured.

3. Locate and activate the buffer tank and appropriate pumps under

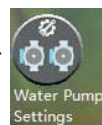



# 4. Assembly Configurations – Drawing 4

## Software: Basic Settings (continued)

3.(cont.) Configure the water pump to operate for heating or cooling:

P2 for Heating Operation

P2 for Cooling Operation

4. The location of the configuration for heating-only or cooling-only system is under

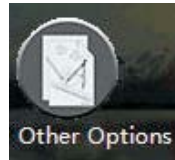

Mode Switch during Defrosting

Mode Signal Output Heating

5. Temperature configuration options for Heating/Cooling circuit 2 are found under



H. configuring the set water heating temperatures:

H.1. Setting a heating curve:

Heating Curve

Water Temp. A/Ambient Temp. 1	40°C
Water Temp. B/Ambient Temp. 2	37°C
Water Temp. C/Ambient Temp. 3	33°C
Water Temp. D/Ambient Temp. 4	29°C
Water Temp. E/Ambient Temp. 5	25°C

H.2. If no heating curve is desired:

Heating Curve

Set Temp. for Heating (without heating curve) 35°C

C. Configuring the set water cooling temperature (if applicable):

Set temp. For Cooling 24°C

5.1. Activate the mixing valve to manage the second circuit:

Mixing Valve

*Note: This pair of settings will interpret "Heating/Cooling Circuit 2 as the low demand distribution system, requiring a lower set temperature for heating and higher set temperature for cooling.*

6. Double-check to ensure that the Domestic Hot Water option is enabled under

Sanitary Hot Water

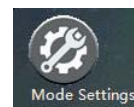

7. Configure the desired setpoint for water temperature (default set to 50°C):

Setpoint DHW 50°C

Dependent on whether cooling is needed

# 4. Assembly Configurations – Drawing 5

Please ensure that the configuration matches the assembly drawing depicted on the right for a two temperature zone setup that includes domestic hot water, also that utilizes the secondary pump for a heating-only operation.

*Note: For the heating-only circuit, a motorized two-way valve can be connected to the unit, to cut the water supply during heating operation.*

*Refer to the next page for wiring and software operation instructions.*

Name	Symbol	Name	Symbol
Temp. Sensor		Water pump	
Safety valve Kit		Mixing valve	
Ball valve		Expansion tank	
Water filter			
Air purging valve			

*Note: Dotted lines mean "able to be controlled by the Heat Pump".*

*Notice : The Fan Coil Unit, Floor Heating System, and Radiator are placeholder distribution systems only and can be substituted by any other appropriate distribution systems.*

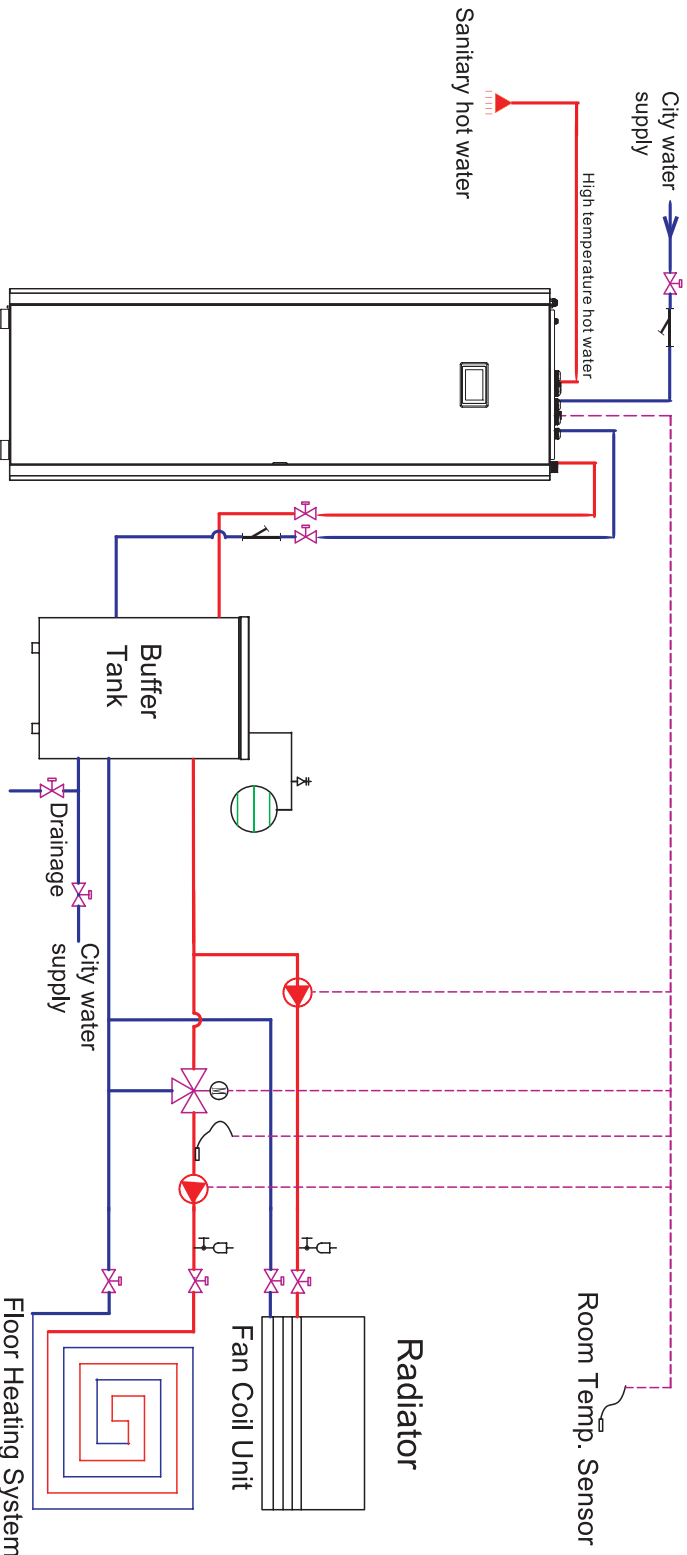

**Two Temperature Zones , without DHW, with a heating-only circuit, by setting the secondary pump to heating-only**

# 4. Assembly Configurations – Drawing 5

## Assembly 5: Wiring Diagram

To achieve successful operation at a minimum, ensure the ports below are properly connected.

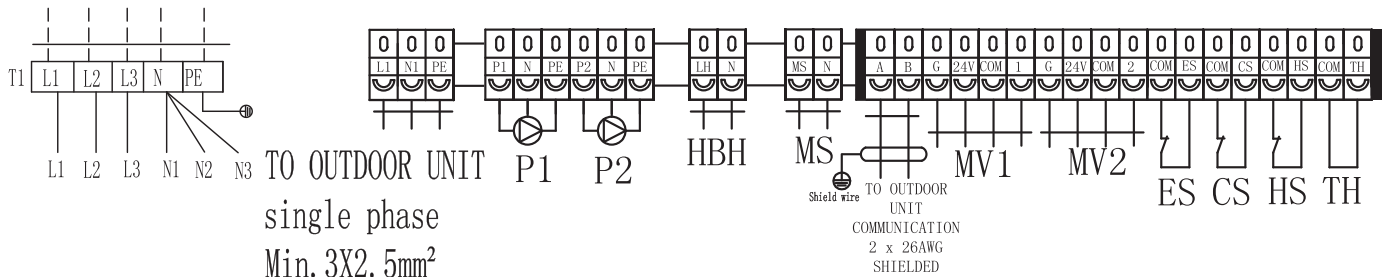

For connection for mixing valve 2, please refer to the appendix A (on page 68-69) of this manual for more information.

## Software: Basic Settings

1. Set the needed working modes of the unit via the menu

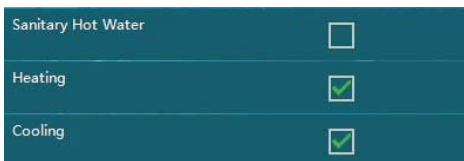
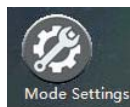

2. Temperature configuration options for Heating/Cooling circuit 1 are found under



**H.** Configuring the set water heating temperatures:

**H.1.** Setting a heating curve:



Ambient Temp. 1	-25°C
Ambient Temp. 2	-15°C
Ambient Temp. 3	-5°C
Ambient Temp. 4	5°C
Ambient Temp. 5	10°C

Water Temp. A/Ambient Temp. 1	40°C
Water Temp. B/Ambient Temp. 2	37°C
Water Temp. C/Ambient Temp. 3	33°C
Water Temp. D/Ambient Temp. 4	29°C
Water Temp. E/Ambient Temp. 5	25°C

**H.2.** If no heating curve is desired:

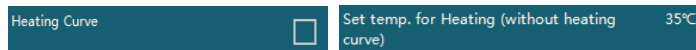

**C.** Configuring the set water cooling temperature (if applicable):

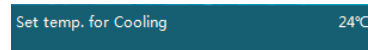

If cooling function is desired, ensure these sections are configured.

3. Locate and activate the buffer tank and appropriate pumps under

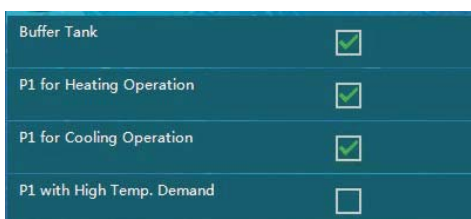
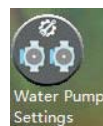

# 4. Assembly Configurations – Drawing 5

## Software: Basic Settings (continued)

3.(cont.) Configure the water pump to operate for heating or cooling:



4. Temperature configuration options for Heating/Cooling circuit 2 are found under

H. configuring the set water heating temperatures:

H.1. Setting a heating curve:



Water Temp. A/Ambient Temp. 1	40°C
Water Temp. B/Ambient Temp. 2	37°C
Water Temp. C/Ambient Temp. 3	33°C
Water Temp. D/Ambient Temp. 4	29°C
Water Temp. E/Ambient Temp. 5	25°C

H.2. If no heating curve is desired:



Set Temp. for Heating (without heating curve)	35°C
-----------------------------------------------	------

C. Configuring the set water cooling temperature (if applicable):



4.1. Activate the mixing valve to manage the second circuit:



*Note: This pair of settings will interpret “Heating/Cooling Circuit 2 as the low demand distribution system, requiring a lower set temperature for heating and higher set temperature for cooling.*

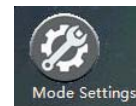

5. Double-check to ensure that the Domestic Hot Water option is enabled under



6. Configure the desired setpoint for water temperature (default set to 50°C):



# 5. Installation Walkthrough

---

## 5.1. Sanitary Hot Water Configurations

---

### 5.1.1. Note about the Heating/Cooling Distribution System

Users are heavily recommended to install a buffer tank into the chosen configuration, especially when the method of hot water distribution is below 20L/kW of water volume.

The buffer tank should be installed between the heat pump and the distribution system, in order to:

- Ensure the heat pump unit provides a stable and sufficient water flow rate.
- Minimize fluctuation of the system's heating/cooling load by storing unused heat.
- Increase capacity of water volume distribution, which helps ensure proper heat pump operation.

If the method of hot water distribution is capable of dispersing a large enough flow rate, a buffer tank can be excluded from installation into the configuration. If so, please move the cooling/heating temperature sensor (TC, #10 on page 1) to the water return pipe, so that fluctuations of water temperature due to compressor speed changes are minimized.

# 5. Installation Walkthrough

## 5.2. Heating and Cooling Circuits

This heat pump unit is capable of controlling two completely different heating and cooling circuits, as shown in the following images.

Configuring the temperatures for circuits 1 and 2 can be done via the “Heating and Cooling Circuit” menus.

If only one circuit is desired, then “Heating and Cooling Circuit 2” can be set to OFF.

### 5.2.1. Heating & Cooling Circuits

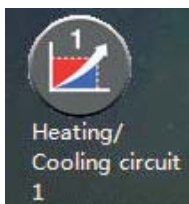

Heating/Cooling Stops Based on Water $\Delta T$	2°C
Heating/Cooling Restarts Based on Water $\Delta T$	2°C
$\Delta T$ Compressor Speed-reduction	2°C
Set temp. for Cooling	24°C
Heating Curve	<input checked="" type="checkbox"/>



Heating/Cooling Circuit 2	<input type="checkbox"/>
Set temp. For Cooling	24°C
Set Temp. for Heating (without heating curve)	35°C
Mixing Valve	<input type="checkbox"/>
Heating Curve	<input checked="" type="checkbox"/>

The basic understanding of these settings is found under your the software section of your particular assembly walkthrough in Chapter 3. A more detailed explanation can be located in the user’s manual.

# 5. Installation Walkthrough

## 5.2. Heating and Cooling Circuits

### 5.2.2. Mixing Valves MV1 and MV2



If the system water temperature may be higher (or lower) than the temperatures needed for circuit 1 (or circuit 2) in a heating or cooling operation, then a mixing valve can be added to the circuit, and connected to the MV1 (or MV2) port on the indoor unit.

The unit will control the mixing valve, continuously mix the supply, and return the water of the circuit to have its temperature read via the TV1 (or TV2) until the value set under the above menus is achieved.

TV1 and/or TV2 should be activated on the installer's level via the "Heating and Cooling Circuit" menu.

Note: A mixing valve is needed, if:

- The system has two circuits that require different water temperatures. The heat pump will have to take the higher/lower (depending on whether heating/cooling) settings of the two circuits as the set temperature for the heat pump. The mixing valve ensures correct water temperature circulation in this instance.
- The system has other heating sources inside that are not controlled by the heat pump. In this case, the actual water temperature may exceed the set temperature.



# 5. Installation Walkthrough

## 5.2. Heating and Cooling Circuits

### 5.2.3. Circulation Pump Control



Buffer Tank	<input type="checkbox"/>
P1 for Heating Operation	<input type="checkbox"/>
P1 for Cooling Operation	<input type="checkbox"/>
P1 with High Temp. Demand	<input type="checkbox"/>
P2 for Heating Operation	<input type="checkbox"/>
P2 for Cooling Operation	<input type="checkbox"/>
P2 with High Temp. Demand	<input type="checkbox"/>

*Note: P1 is circulation pump 1, P2 is pump 2*

- “Buffer Tank” should be checked if one is installed between the heat pump and distribution system.
- “P1/P2 for Heating/Cooling Operation” sets that circuit’s pump to work for heating or cooling.

If “Buffer Tank” is NOT checkmarked, both P1 and P2 will only work when the compressor is working in the same mode that the pump is set to. So, if P1 is set to “P1 for Heating Operation”, P1 will activate ONLY when the compressor is working in heating mode. If P1 is checkmarked for both “Heating” and “Cooling” operations, then P1 will be ON when the compressor is working in both heating and cooling modes. The pump stops when switched to DHW mode, or after the set temperature is reached.

If “Buffer Tank” IS checkmarked, both P1 and P2 will work as long as there is demand from the distribution system, as per the pump setting. The following must also be fulfilled:

- Actual temperature in the buffer tank (detected via TC) is equal or above 20°C (in heating)
- Actual temperature in the buffer tank (detected via TC) is equal or below 23°C (in cooling)

Even if the unit is working in DHW mode, or the set temperature is reached, the circulation pump will start to work as long as there are heating/cooling demands, and TC is fulfilled as per the above.

- “P1/P2 with High Temp. Demand” sets P1/P2 to automatically stop if the signal for “high demand” is off. For more information regarding this setting, please refer to part D on page 62.

**NOTE:** It is very important to place the temperature sensor (TR) in a central location with good circulation, with no hot or cold equipment nearby, in a column or interior wall, or somewhere similar.



# 5. Installation Walkthrough

---

## 5.3. Indoor Unit Installation

---

### 5.3.1. Choosing an installation location

- A. The indoor unit can be located in a room, corridor, balcony, garage or warehouse.
- B. Indoor unit should be placed on flat and solid ground.
- C. The unit is recommended to be put in a space close to water supply, and drainage.
- D. The outdoor and indoor unit should be placed close, to save the copper tube as well as the energy.
- E. The indoor unit shall be placed in dry and well-ventilated environment.
- F. Indoor unit mustn't be installed in an environment where volatile, corrosive or flammable liquid or gas exists.
- G. During the movement, please be careful to keep the unit vertically. If the unit is tilted by  $30^{\circ}$  , it may fall down and cause damage to itself or the porter.
- H. Don't expose the operation panel under direct sunshine.
- I. Enough space should be left around the indoor unit for futher maintenance.

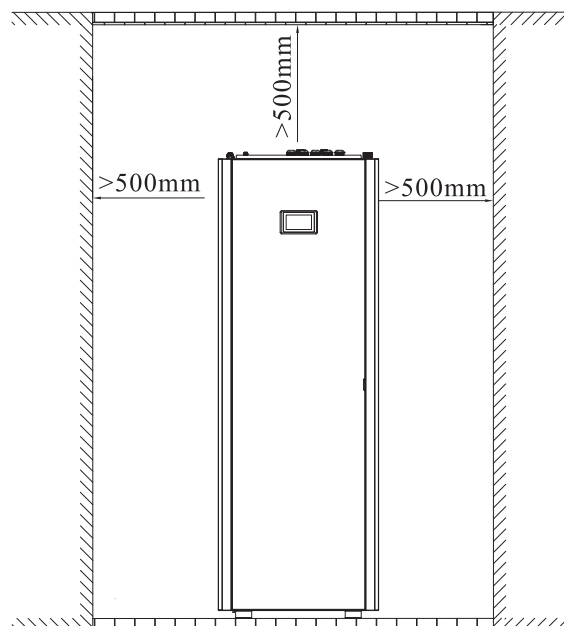

# 5. Installation Walkthrough

## 5.4. Outdoor Unit Installation

### 5.4.1. Choosing an installation location

- A. The outdoor unit can be located in a room, corridor, balcony, and roof or hanged on the wall.
- B. Please don't install outdoor unit close to bedroom or living room, because there is some noise when it's running.
- C. The outdoor unit shall be placed in dry and well-ventilated environment.
- D. Outdoor unit mustn't be installed in an environment where volatile, corrosive or flammable liquid or gas exists.
- E. Please cover a protecting roof over the outdoor unit, lest ice or snow blocks the air inlet. Shield the unit from direct sunshine, rain or snow, but never cover the unit which will cause the bad ventilation.
- F. Please ensure there is drainage system around the location, to drain the condensed water under defrosting mode.
- G. Please don't install the indoor and outdoor unit in damp locations, otherwise it may cause short-circuit or corrosion of some components. The unit should be free from corrosive and moisture surrounding. Otherwise the lifetime of the unit might be shortened.
- H. When installing the unit in harsh climatic conditions, sub-zero temperatures, snow, humidity area, please raise the unit above the ground by about 20cm.
- I. When installing the unit, tilt it by 1cm/cm to left side of the unit (see from front), for better water drainage.
- J. Outdoor unit should be placed on flat and solid ground. When installing the outdoor unit, please ensure enough space around the outdoor unit, for better ventilation and maintenance. Please refer to the illustration below.

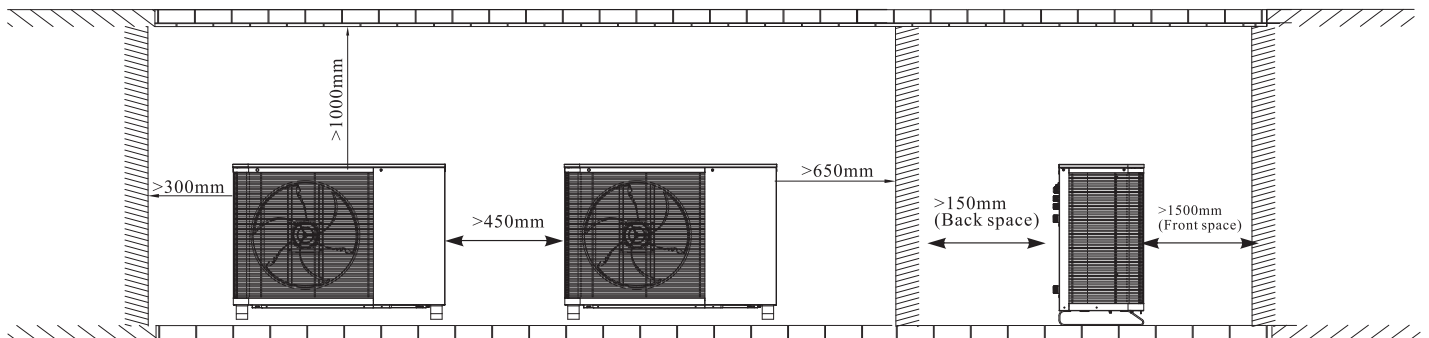

# 5. Installation Walkthrough

## 5.4. Outdoor Unit Installation



Please add rubber absorber under the outdoor unit, to reduce the vibration.

### 【A. On a concrete stand】

1. The unit must be located on a flat, solid, preferably cemented surface.
2. When installing the unit, introduce a tilt of 1cm/m for rain water evacuation.
3. When installing the unit in harsh climatic conditions, sub-zero temperature, snow, humidity..., it is recommended to raise the unit off the ground by about 50cm.
4. It is recommended to have a base with following size for these units:
5. Rubber vibration absorbing mountings are recommended.
6. When sitting he unit, take care to leave sufficient free space all around it for carrying out maintenance.

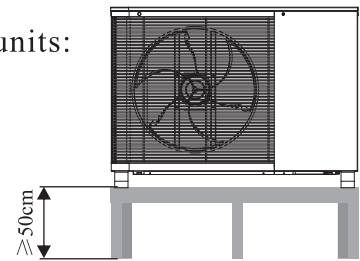

### 【B. On brackets on the wall】

**A: If needs to hang the outdoor unit on the wall, please do as followings:**

1. Adjust the location of the wall brackets according to the distance between two feet of the unit.
2. Fix the brackets on the wall with expansion bolts.
3. Place the outdoor unit on the brackets. A Vibration absorbers are recommended to reduce vibration and noise.
4. Fix the unit to the bracket.

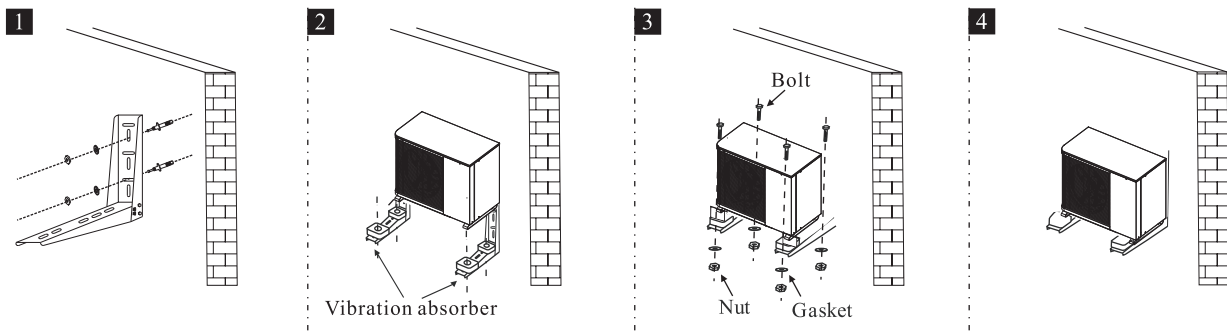

The refrigerant piping and signal cable between indoor and outdoor unit should go through the wall by using a wall sleeve.

The hole should lean to outside a little bit ( $\geq 8$  degrees), to avoid rain water or condensate water flow back to the indoor.

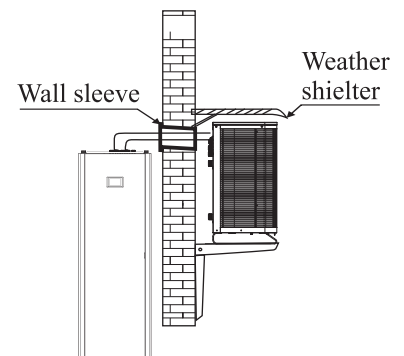

# 5. Installation Walkthrough

## 5.5.Refrigerant pipe connection and water pipe connection

### 5.5.1. Refrigerant Pipe Connection

When insulating the refrigerant pipe, please insulate each pipe separately (refer to figure 1 below), don't insulate the refrigerant pipes together (refer to figure 2 below).

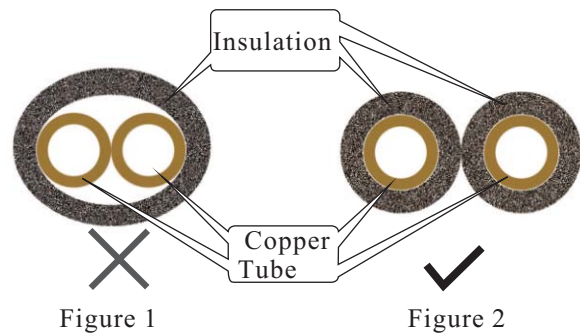

### 【Holes】



Start by drilling with the detection drill to check that there are no obstacles in the way and that the hole on the outside will be correct. Holding the detection drill sideways, feel inside the wall if there is anything in the way around the detection drill's hole.

If there is nothing obstructing the detection drill, the wall bracket can be fitted and the hole (about 80mm) drilled. Check the dimension or the supplied wall bushing.

Set the drill at low speed to prevent a build-up of heat and the saw teeth becoming "sticky". It is also a good idea to pre-drill with a 12-15mm bit so that any chips in the wall can run out.

# 5. Installation Walkthrough

## 【Pipe Routing】

### IMPORTANT:

Continue the pipe from the indoor unit to the outdoor unit and connect the pipe fittings in the same way. The radius at pipe bends must not be less than 15 cm. Use a cardboard template to check this. Run the power cord along with the pipes. Create the bends gradually and carefully. You must not bend the pipe straight across, for example, to the edge of the hole in the wall.

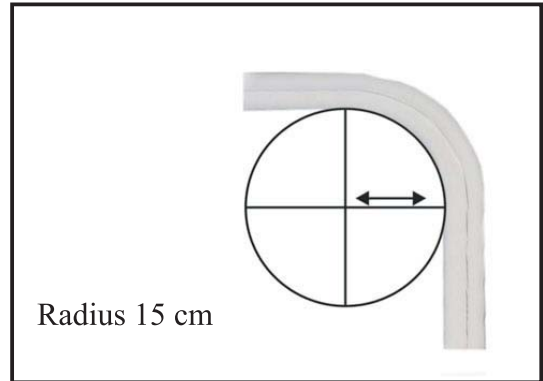

**Note:** When vacuuming the system, please don't turn on the high/low pressure valve. Otherwise refrigerant leaks.

6kW

A-1/4" liquid valve

B-1/2" gas valve

9/12kW

A-3/8" liquid valve

B-5/8" gas valve

Connector of vacuum pump

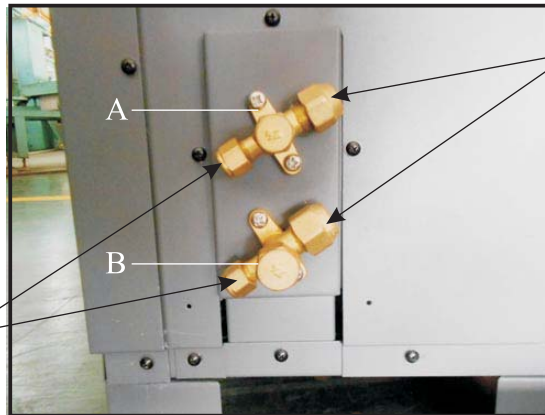

Connector for refrigerant pipe

**Note:** When vacuuming the system, please don't turn on the high/low pressure valve. Otherwise refrigerant leakage.

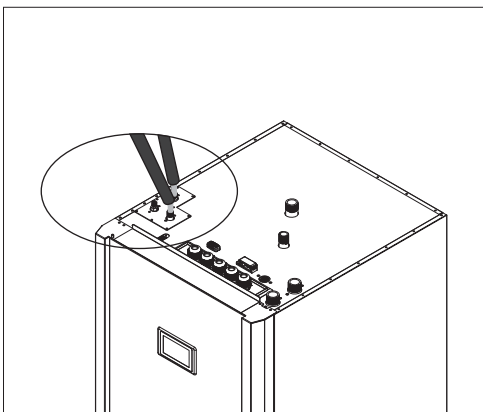

1. Connect the refrigerant piping to the indoor unit.

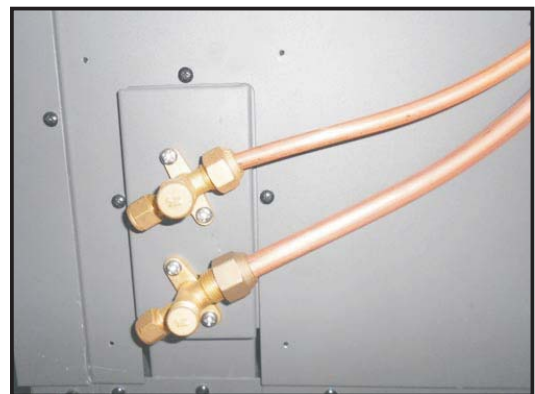

2. Connect the other ends of the refrigerant pipe to the outdoor unit.

# 5. Installation Walkthrough

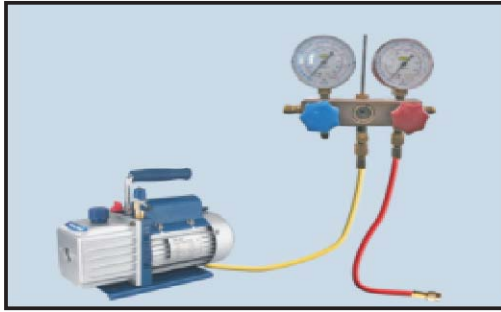

3. Prepare a vacuum pump and a pressure gauge, connect one tube of the pressure gauge to the vacuum pump.

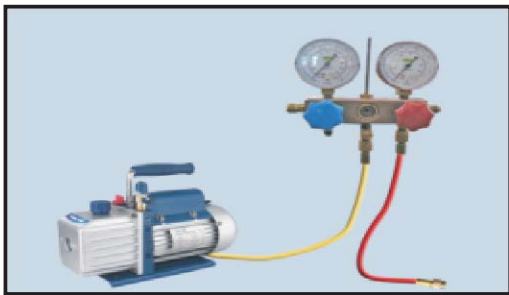

6. Take off the copper nut of the gas and liquid valves, open the valves with hexagon spanner as much as possible.

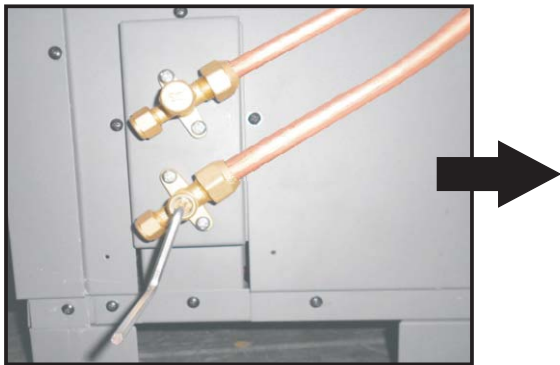

7. Check with leakage detector or soap water if there is any leakage. If not, then put back the copper nuts onto the valves.

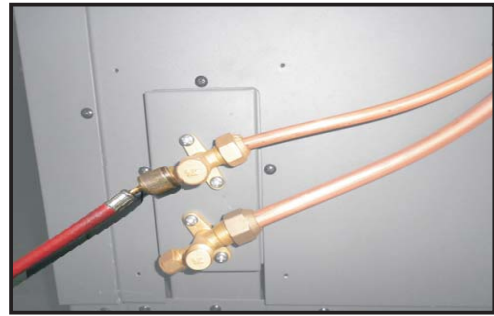
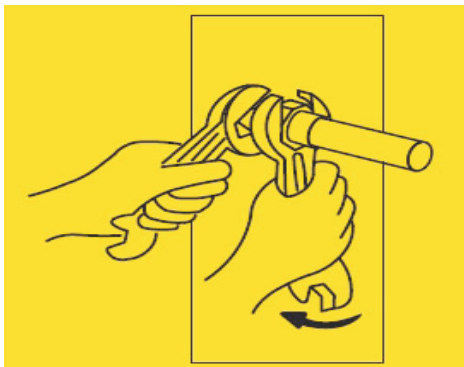

4. Connect the other tube of the pressure gauge to the outdoor unit.

5. Open pressure gauge, and start the vacuum pump to vacuum the unit for around 10 minutes. When the pressure gauge shows negative pressure, close the pressure gauge and stop vacuuming.



**Attention:** The liquid valve can't be opened until the vacuumizing has been totally finished.



Hexagon Spanner: M5

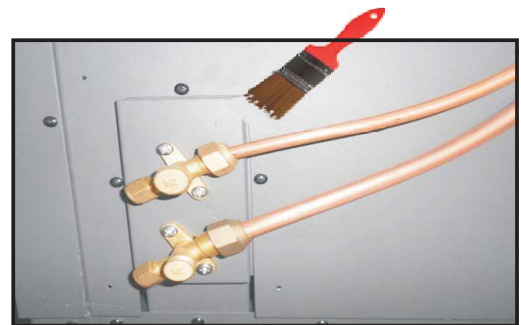

**CAUTION:** When loosening a connector, always use two wrenches together. When connecting the piping, always use a spanner and torque wrench together to tighten the flare nut to prevent flare nut cracking and leaks.

## 5. Installation Walkthrough

---

Gas piping length and gas amount for 6/9/12kW R32 split unit		
Model no.	R32 gas piping length and gas amount	Model no. of compressor oil
6kW 9kW 12kW	<ol style="list-style-type: none"><li>1. The gas in the unit is enough for 7.5m long pinping, if the piping is beyond 7.5m, please add 30g per meter.</li><li>2. It's recommended that the gas piping should not exceed 20m.</li></ol>	FW68S (The oil in the compressor is enough for 20m long piping)



# 5. Installation Walkthrough

## 5.5.2. Water pipe connection

After installing the unit, please connect the water inlet and outlet pipe according to the local instructions. Please carefully select and operate the water pipe.

After connection, the water piping should be pressure tested, cleaned before use.

### 【Water filling】

#### ▲ One way valve:

One way valve must be installed to water filling connector, to avoid back-flow of water when water supply stops or water pressure not enough (one way valve is packed with the unit).

#### ▲ Filter:

A filter (20 mesh/cm<sup>2</sup>) should be installed at the water inlet of water tank as well as that of indoor unit, to avoid sediments and guarantee water quality.

#### ▲ Ball valve:

A ball valve is recommend for easy operation of drainage or filter cleaning.

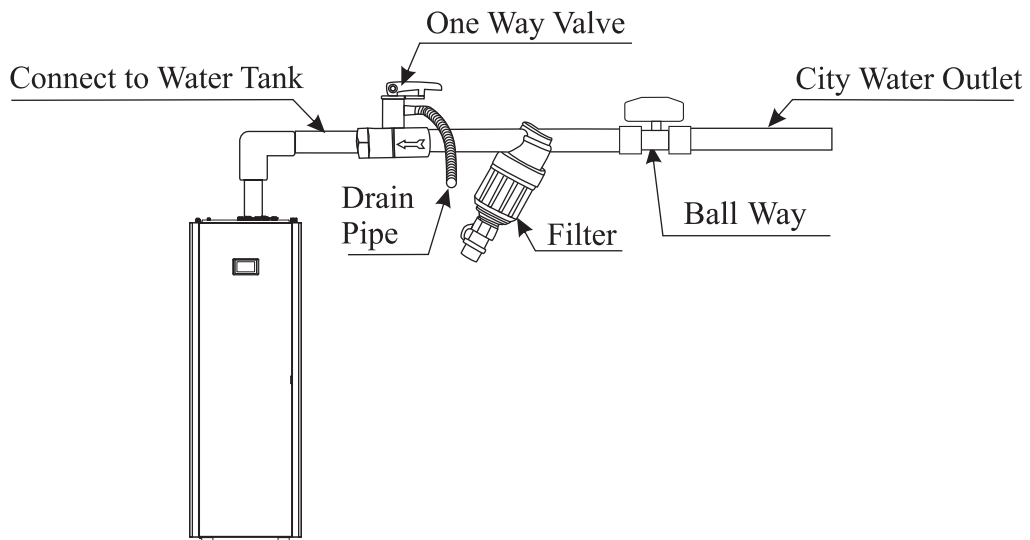

### 【Connect of drainage pipe】

When the tank need to be drained, please do as per following instruction:

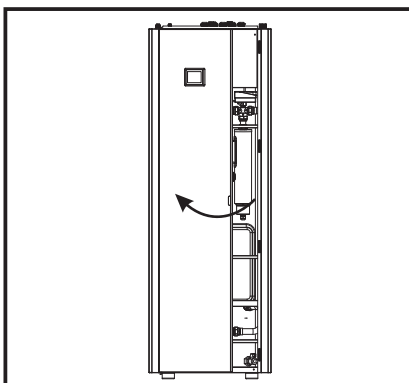

1. Open the door.

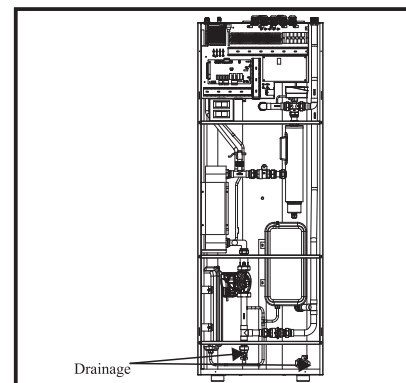

2. A soft pipe and ball valve have already been connected to the tank. please pull it out from the unit.



## 5. Installation Walkthrough

### 5.6. Installation of the kits in the accessories

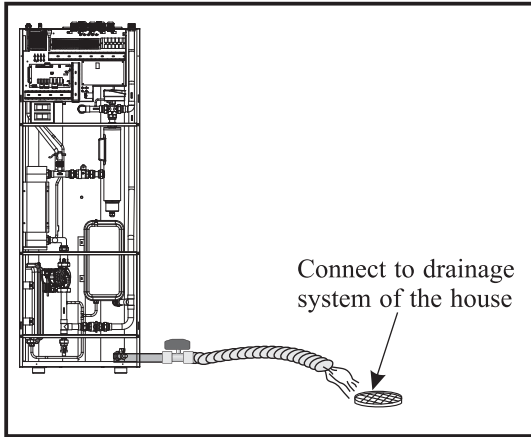

1. Drain the water to drainage system of the house, and open the ball valve to drain out all water inside the tank. Please extend the drainage pipe by connecting another water pipe, if the distance between the unit and drainage system is long.

#### 【Insulation】

All pipes running hot water should be well insulated. The insulation must be tied up tightly without gap (But please don't wrap up the check valve for future maintenance).



*Please ensure enough water pressure to deliver the water to the required height. If the water pressure is not enough, please add water pump to increase the pumping head.*

#### 【Automatic air purging valve】

The automatic air purging valve is in the accessories.

1. Take the air purging valve from the accessories.
2. Apply sealant on threads of the G1/2" male connector upon the water tank according to the industry standards.
3. Find the connector "automatic air vent" on the top of water tank according to the label and install the air purging valve onto it.

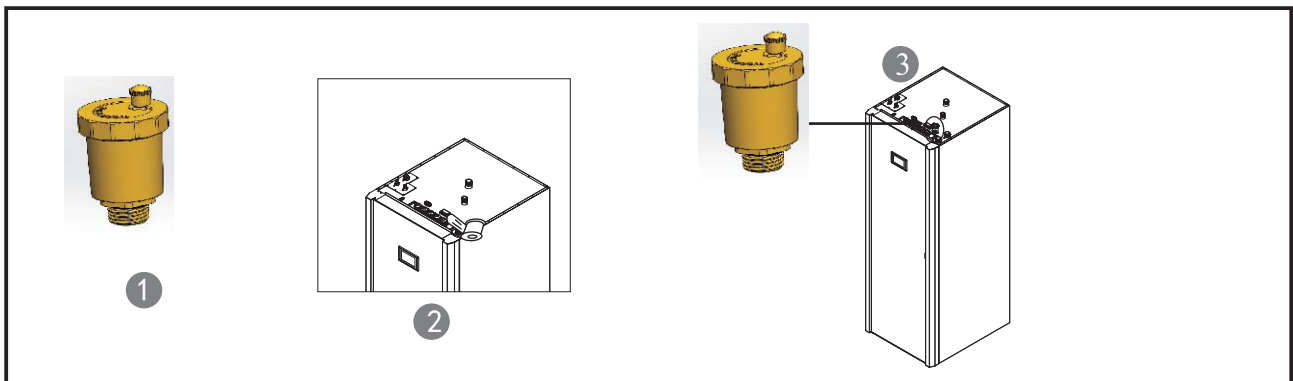

# 5. Installation Walkthrough

## 5.7. Wiring

### 5.7.1. Explanation of Terminal Block 1

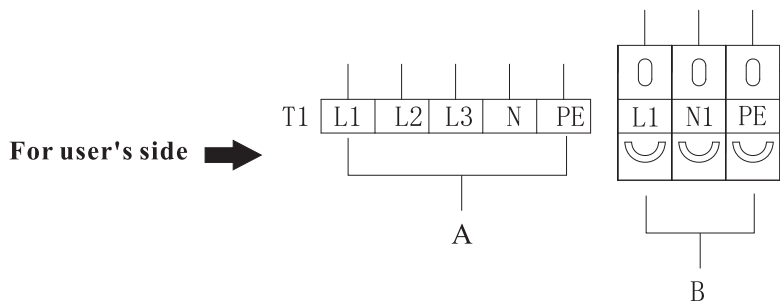

#### **A: Unit power supply**

This should be connected directly to the city power supply.

For all units, ensure that a cable of sufficient gauge is used. (found on nameplate)

#### **B: Outdoor unit power supply(for split units)**

If the outdoor unit draws power from the indoor unit, this terminal should be connected through cable between the appropriate ports (see Appendix for wiring diagrams).

# 5. Installation Walkthrough

---

## 5.7. Wiring

---

### 5.7.2. Explanation of Terminal Block 2

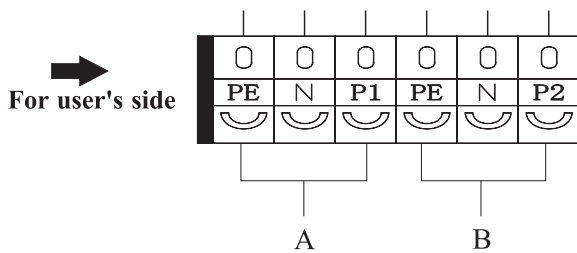

#### A, B: Water Pump

A-Pump 1: Pump for Heating & Cooling Circuit 1,  
B-Pump 2: Pump for Heating & Cooling Circuit 2,

If there is an external water pump in heating, cooling and hot water system, it can be connected to these ports, to be under the control of heat pump,

# 5. Installation Walkthrough

## 5.7. Wiring

### 5.7.3. Explanation of Terminal Block 3

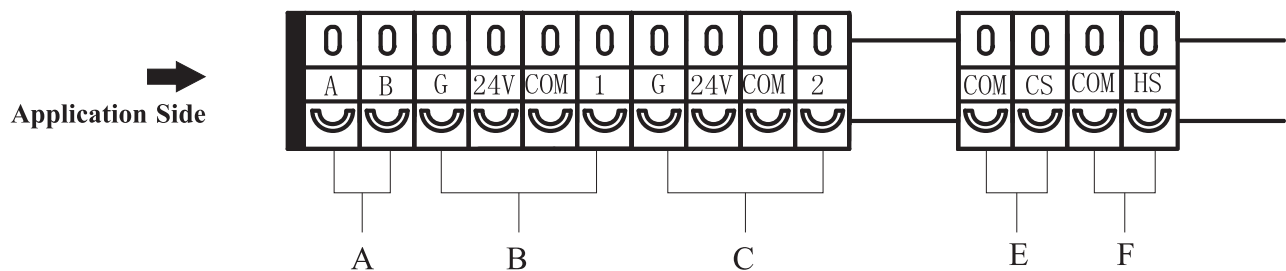

**A:** Signal cable between indoor and outdoor unit.

**B,C: Motorized Water mixture valve 1&2:**

As explained in System illustration chapters, this unit can have two water mixture valves for distribution system under its control. Water Mixture Valve 1 for Heating & Cooling circuit 1  
Water Mixture Valve 2 for Heating & Cooling circuit 2

**E,F: Cooling and Heating Mode Switchovers**

This unit is capable of switching between heating and cooling automatically, according to the ambient temperature, or external signal input. Please refer to the user’s manual for more detailed explanations on ambient temperature setting. For external signal input, the external signal should be connected to “Cool Mode Switch” for cooling operation, and “Heat Mode Switch” for heating operation.

# 5. Installation Walkthrough

## 5.7. Wiring

### 【Important Notice】

#### With 400V/50Hz/3Ph power supply (as default):

Use wiring diagram A1. L1, L2 and L3 from terminal block T2 should be connected to terminal R, S and T of terminal block T1; N1, N2 and N3 from terminal block T2 should be connected to terminal N of terminal block T1. Power supply cable must be able to carry the maximum running current of the system (recommand to use power cable no smaller than 2.5mm<sup>2</sup>).

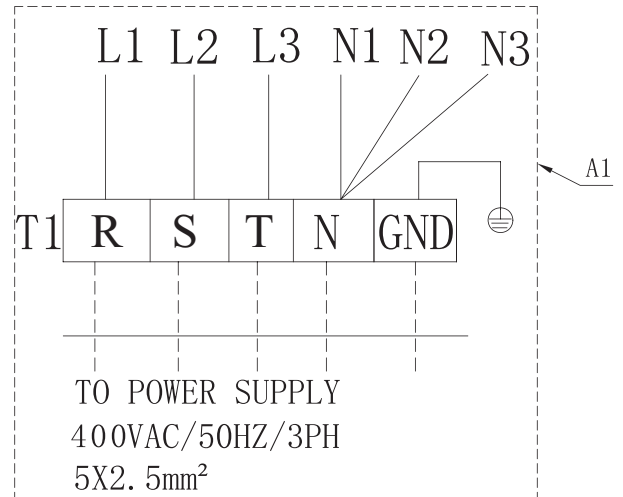

#### With 230V/50Hz/1Ph power supply:

Use wiring diagram A2. L1, L2 and L3 from terminal block T2 should be connected to terminal R of terminal block T1; N1, N2 and N3 from terminal block T2 should be connected to terminal N of terminal block T1. Power supply cable must be able to carry the maximum running current of the system (recommand to use power cable no smaller than 10mm<sup>2</sup>).

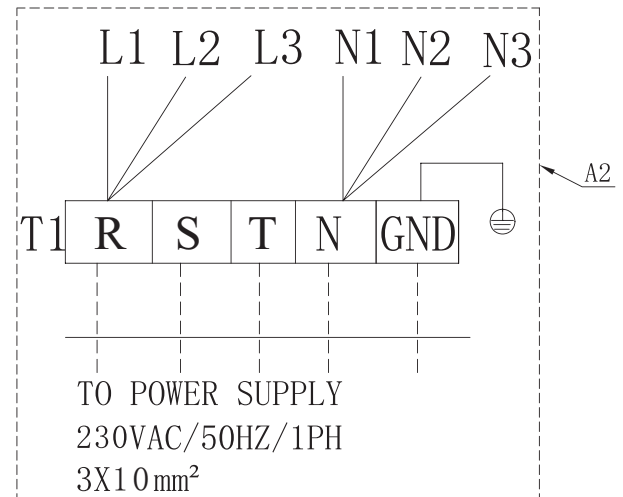

#### With 230V/50Hz/3Ph power supply:

Use wiring diagram A3. L1 and N1 from terminal block T2 should be connected to terminal R of terminal block T1; L2 and N2 from terminal block T2 should be connected to terminal S of terminal block T1; L3 and N3 from terminal block T2 should be connected to terminal T of terminal block T1; Power supply cable must be able to carry the maximum running current of the system (recommand to use power cable no smaller than 6mm<sup>2</sup>).

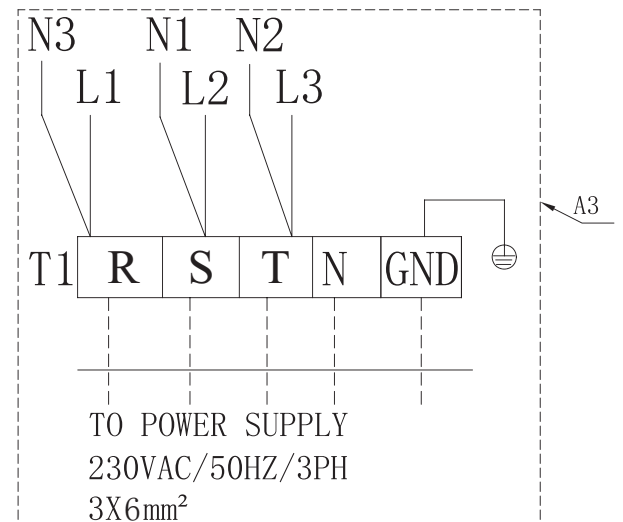

# 5. Installation Walkthrough

## 5.7. Wiring

### Power supply and electric connections

This unit has a maximum combined output (hot water and heating) of 16,5/18,5/20,5 kW (depending on model). To get maximum output, the unit needs a total of 11 kW power input. However, the unit's output and consumption can be adjusted in accordance to the available power input in the building, and type of backup heater you want to connect. The minimum input is 3 kW.

**Observe! If internal back up heaters are not connected, the heat pump must be connected to external automatic backup heating device for space heating and hot water.**

Before doing the electric installation you need to plan how much of the unit's total capacity you wish to use, and what kind of power supply that is available (230V or 400V, single phase or three phase). Below it is listed different power consumers built in the unit, and the power input and voltage needed to run them.

Power consumer	Power	Voltage	Circuit breaker	Explanation
Heat pump + hot water heater	3,5-4 kW	230V/1-ph	25A	Can be individually connected with 1-4 individual 230V/1-ph power supply
Backup heater 1	3,0 kW	230V/1-ph	16A	
Backup heater 2	3,0 kW	230V/1-ph	16A	
Heat pump + hot water heater + Backup Heater 1 + Backup heater 2	9,5-10 kW	400V/3-ph or 230V/3-ph	25A	Heating system connected to 400V/3-ph or 230V/3-ph power supply

**Note:** There has a "Emergency Switch" inside the unit. This switch should only be switched ON when compressor system is break down. When it is set to ON, it will activate the power connection to a 3kW heater, which shares the power supply of heat pump unit.

# 5. Installation Walkthrough

## 5.7. Wiring

### 5.7.4. Wiring Process Preliminary Precautions



- Please ensure that a suitable circuit breaker is used for the heat pump.
- The power supply to the heat pump unit must be grounded.
- Wiring should be done by a licensed professional, and comply with industry regulations.
- The unit should be completely powered off before any wiring is done.
- Cables should be properly fastened into place, to prevent loosening from occurring.
- No cable should be fastened to another.
- The power supply should be compliant to all standards located in the rating label.
- The power supply, necessary cables, and sockets should fully meet the input power requirements of the unit.

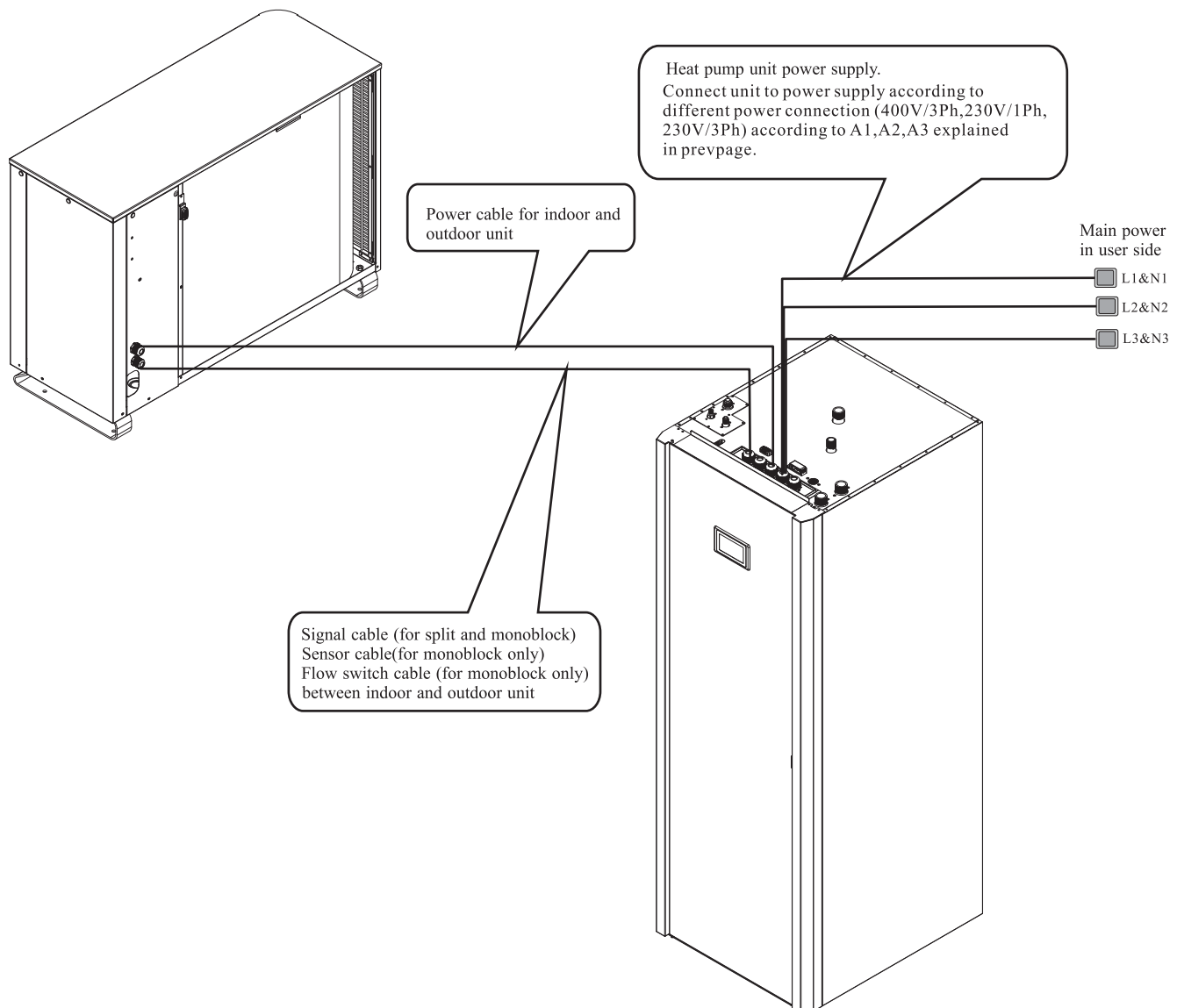

# 5. Installation Walkthrough

## 5.7. Wiring

### 5.7.5. Wiring Process

- 1) Open the indoor unit's front panel and remove the electrical box cover.

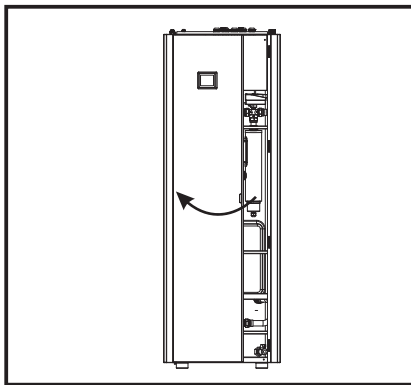

1. Open the door.

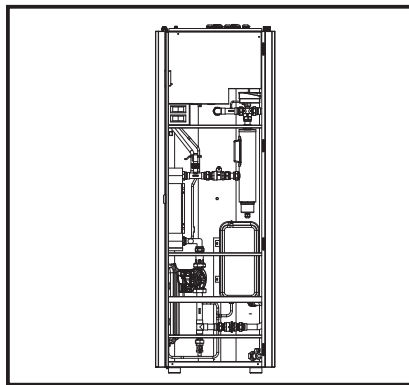

2. Remove the screws on the electric box.

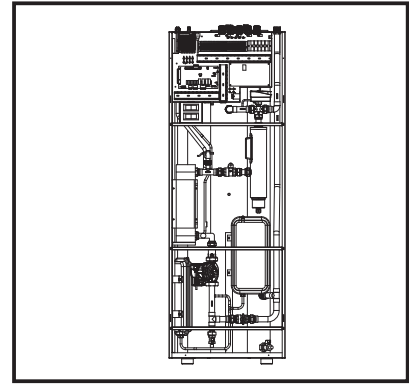

- 2) Acquire power cables of suitable length that is compliant to all local safety regulations.

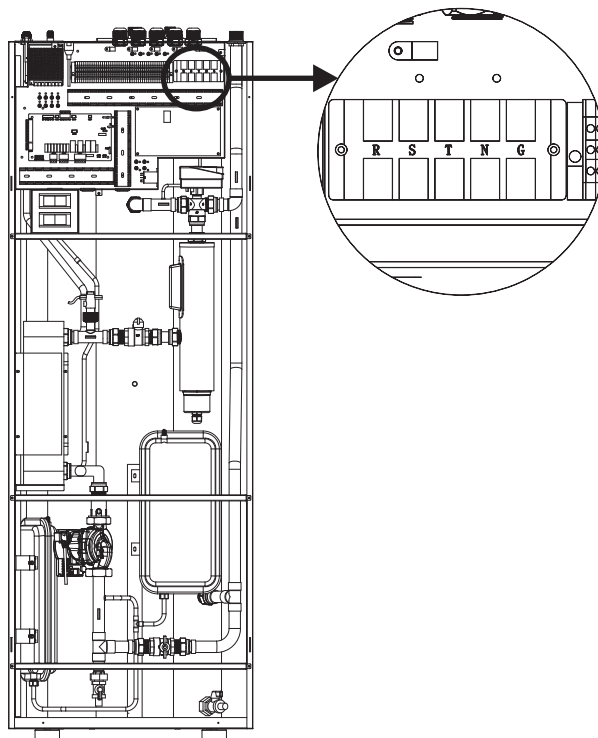

Connect power cables to the power supply terminal inside the unit.



# 5. Installation Walkthrough

## 5.7. Wiring

3) Connect the signal cable between the indoor and outdoor unit:

Retrieve the signal cable from the accessories bag.

4) Connect the Plate electrical heating power cord between the indoor and outdoor unit .

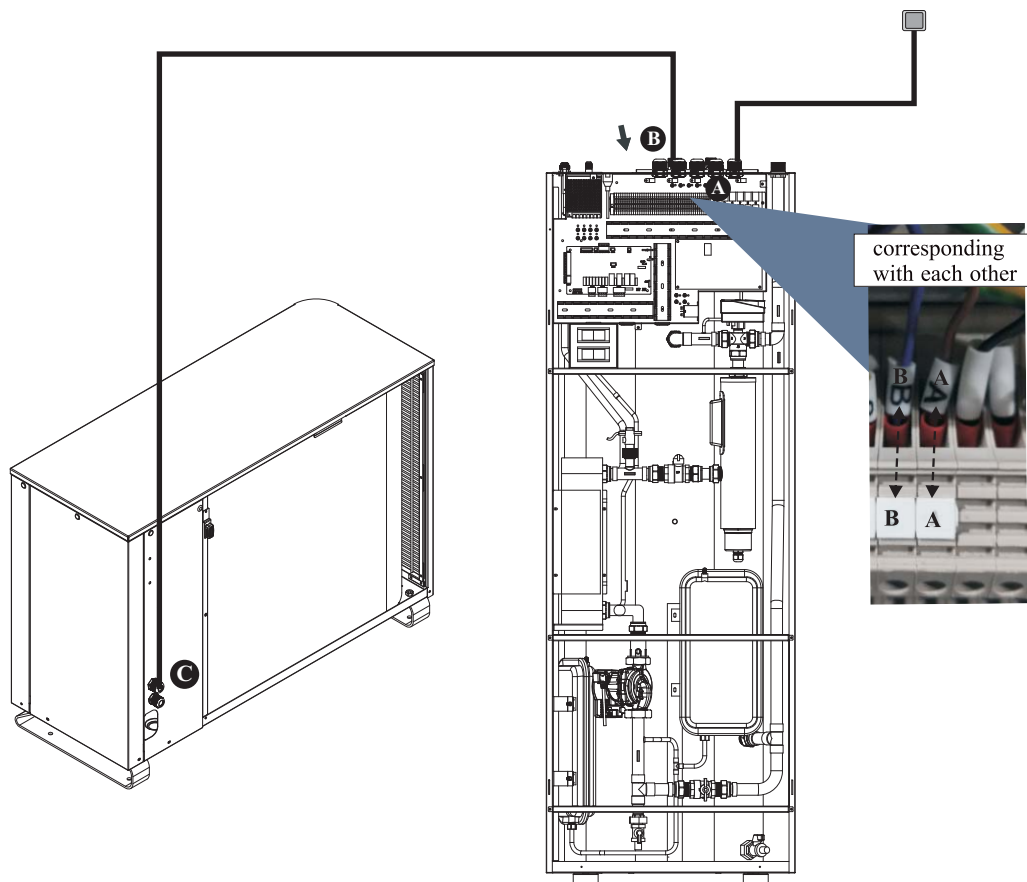

- A. Insert one end of this cable through the cable gland on the top of the indoor unit, and connect it to A ,B on the appropriate terminal block.
- B. Fasten the cable gland to ensure the cable won't get loosen.
- C. Connect the other end of the cable to the terminal block on the outdoor unit. A ,B on the indoor unit should be connected with A, B on the outdoor unit, otherwise communication failure error may occur.

For monoblock unit, connect sensor cables and flow switch cables between indoor and outdoor unit as per wiring diagram and marks on the cable.

## 5. Installation Walkthrough

### 5.7. Wiring

- 5) Tc (cooling&heating water temperature sensor) and Tr (room temperature sensor) are pre-connected and put inside the indoor unit. Following below instructions if they need to be moved to another place.

- Retrieve all sensors and communication cables from the accessories bag.
- Connect all sensors to the communication cables, and insert the male end into the indoor unit through the cable glands.
- Connect them to the female quick connectors inside the indoor units.
- Place all sensors in the correct positions.
- After everything is connected, fasten the cable glands to prevent cables from loosening.

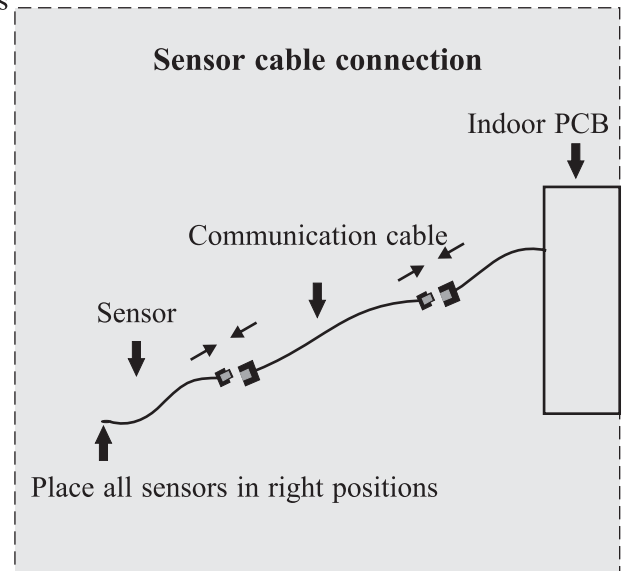

- 6) Re-install the electrical box cover, the side panel, and close the indoor unit door.

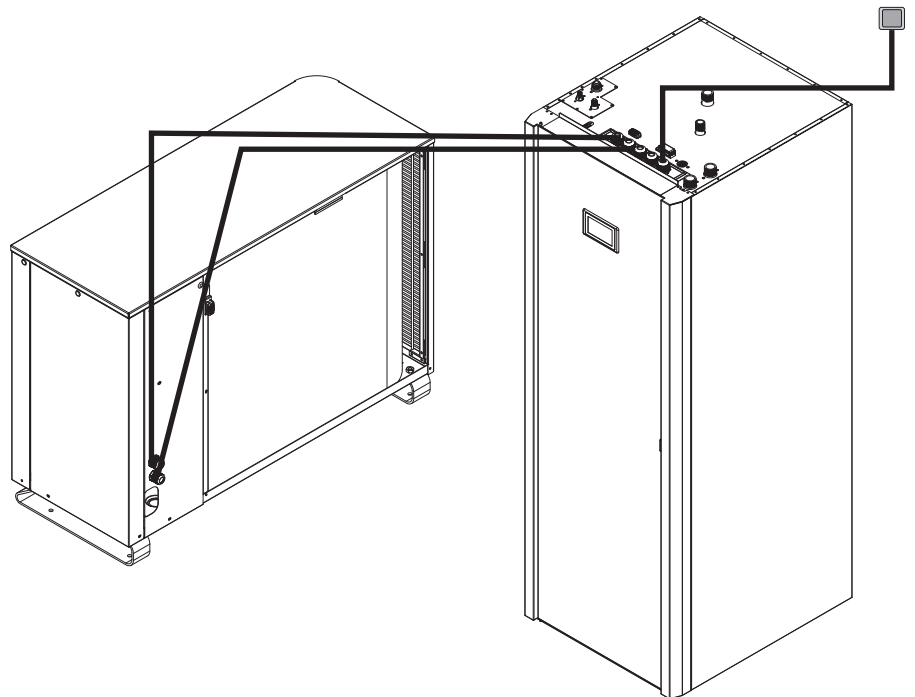

The wiring process is then complete.

## 5. Installation Walkthrough

---

### 5.8. Attention

---



- A. The user mustn't change the structure or wiring inside the unit.
- B. The service and maintenance should be performed by qualified and well-trained technician. When the unit fails to run, please cut off power supply immediately.
- C. The smart control system can automatically analyze various protection problems during daily use, and display the failure code on the controller. The unit may recover by itself. Under normal operation, the pipings inside the unit don't need any maintenance.
- D. Under normal running, the user only needs to clean the surface of the outdoor heat exchanger per month or quarter of a year.
- E. If the unit runs in a dirty or oily environment, please clean the outdoor heat exchanger and heat exchanger by professionals, using specified detergent, to ensure the performance and efficiency of the unit.
- F. Please pay attention to the ambient environment, to check if the unit is installed firmly, or if the air inlet and outlet of the outdoor unit is blocked or not.
- G. Unless the water pump is damaged, no service or maintenance should be taken to the water system inside the unit. It's recommended to clean water filter regularly or change it when it's very dirty or blocked.

# 5. Installation Walkthrough

## 5.9. Electric heating

This unit has included one electric heaters inside. One electric heaters are used to keep the water temperature when heat pump capacity is not enough or heat pump fail to work, as well as heat the water up more rapidly when water temperature is low.

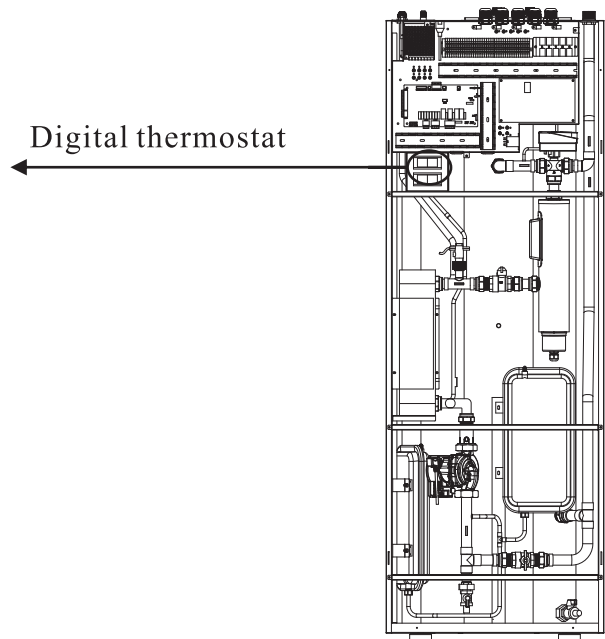
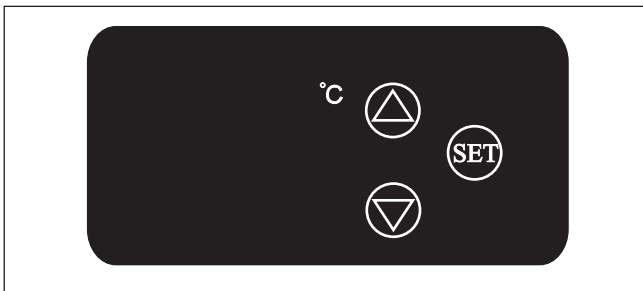

### 【Digital thermostat】

Power supply: 110~240V.

Indicator light OUT

When the electric heater is turned on, the indicator light is always ON.

When the electric heater is turn off, the indicator light is OFF.

Temperature setting: Press SET, the set temperature flickers, press ▲ or ▼ to increase or decrease the set temperature. The controller will save the setting.

Press SET again to exit and show the actual water tempeture in the display. If SET is not pressed, the controller will also exit the setting after 3 seconds and show the actual water temperature in the display.

Control logic

When the thermostat is powered on, the display shows the actual water temperature. When the actual water tempeture is lower than (the set tempeture-3°C), the electric heater is turned on.

When the actual water temperature equals or higher than the set temperature, the electric heater stops.

Failure code

When the actual temperature which sensor detects is higher than 120 °C or the sensor for thermostat is short circuit, the display shows the failure code HH, and the electric heater stops.

When the actual temperature which sensor detects is lower than -45 °C or the sensor for thermostat is open circuit, the display shows the failure code LL, and the electric heater stops.

# 5. Installation Walkthrough

## 5.9. Electric heating

Notice:

1. Please connect the cables according the wiring diagram.
2. The sensor cable can't be packed with power cable or communication cable, please connect them separately, in order to avoid interference.
3. Sensor can't be dip into the hot water for a long time.
4. The thermostat initilize the setting the first second after power on,
5. When the thermostat start to work, please remove the film on the display.

Analog back-up is a function that will kick in as the last reserve, meaning if teh unit has a fatal failure. All circulation pumps will start to run and the integrated el.heater will work for heating and DHW via the two digital thermostats.

**Uper thermostat is for heating.  
Lower thermostat is for DHW.**

The thermostats will controll the 3-way valve to heat up teh sanitary water according to the setting on the thermostat.

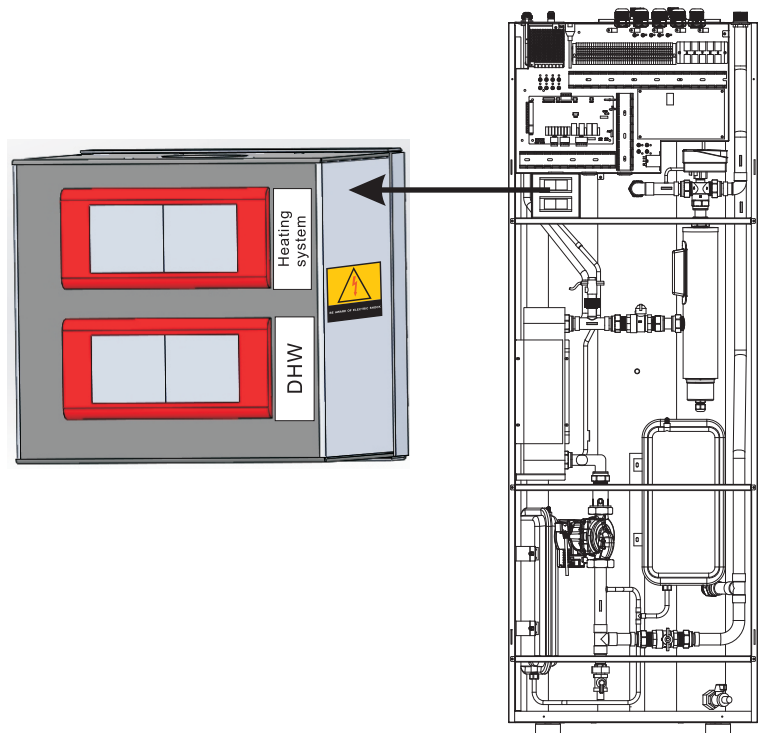

Important: during installation / start-up of the unit the installer must set the digital thermostats accordingly to metch the system. To disable the Analog back-up set the temperatures to 10°C which means that if there is a major failure the thermostats will work only to prevent the water from freezing.

**Note: When the end device is floor heating, the setting water temp. should be lower than 35°C, otherwise there will be a risk of floor cracking.**

# 5. Installation Walkthrough

---

## 5.10. Test run

---



After installation finished, please fulfill the water system with water and purge out air in the system before start-up.

### 5.10.1. Before start-up

The list of verifications below must be performed before the unit starts up, to ensure best possible conditions for smooth long-term operation. The list is not exhaustive, and should only be used on a minimum reference basis:

- 1) Make sure the fans are rotating freely.
- 2) Confirm correct flow directions in water piping.
- 3) Verify all system piping matches installation instructions.
- 4) Check the voltage of the unit power supply and make certain it complies to authorized limitations.
- 5) The unit must be properly grounded.
- 6) Check for the presence of any damaged devices
- 7) Check all electrical connections and ensure they are secure.
- 8) Make sure there are no leaks in the piping and the space is well-ventilated.

Fix any problems above if they occur. If everything above is satisfied, the unit can start up.

### 5.10.2. Starting Up

When the installation of the unit is completed, all water system pipes are confirmed to be well-connected, air purging is done, there are no leakages or other problems, the unit can be powered on.

Turn on the unit by pressing the on/off button on the operation panel. Listen carefully for any abnormal noise or vibrations, and ensure the display of the wired controller is normal.

After the unit has been on for 10 minutes and no abnormalities have occurred, the start-up process is complete. For problems and troubleshooting, please refer to the Service and Maintenance manual.

*Final note: It is suggested to not run "heating" or "hot water" mode during ambient temperatures above 32°C , otherwise the unit may easily enter protection mode.*

## 5. Installation Walkthrough

### 5.11. Circulating pump

#### Technical Parameters

Parameters	Specification description
Electric pump form	Centrifugal circulation pump (non-self-priming)
Power supply (AC/DC)	AC
Voltage	230V
Frequency	50/60Hz
Input power	4~95W
Current	0.04~0.75A
Range of speed	1000-4500r/m
IP protection class	IP 44
Insulation grade	Class F
EEI	≤0.21-Part3
Noise	≤45dB
Maximum lift	9m
Maximum flow	4.5m <sup>3</sup> /h
Matching pipe diameter	DN25
Matching inlet and outlet thread	G1.5
Rotating direction of the rotor	Clockwise from the control box to the pump body

#### Product Functions



No.	Items	Function description
1	Operation and control mode	Internal operation at the maximum constant power + PWM external speed control
2	Start	Maximum torque start
3	PWM external speed control	PWM signal automatically recognizes the entering and exiting speed adjustment mode
4	Display	LED digital tube, display of speed control mode, display of fault code
5	Protection function	Overcurrent protection, over/undervoltage protection, phase loss protection, locked rotor protection, dry running protection
6	PWM feedback	0-4.5m <sup>3</sup> /h, electric pump flow feedback, fault feedback

# 5. Installation Walkthrough







## 5.11. Circulating pump

### Mode display

After the power is turned on, all green LED lights flash 3 times, and the speed control mode is displayed as follows:

Pump status	Display light status	Pump status	Display light status
No PWM signal		PWM signal speed control	

### Fault display

Description of fault protection:		
Function name	Description	Panel display code
Locked-rotor protection	When the rotor shaft of the electric pump is stuck, the electric pump will attempt to restart, and restart every 5s; when attempting to restart, the electric pump reports a blocking error and the panel displays the fault code, and the pump will stop after 5cycles of restart	
Overtoltage/un dervoltage protection	Under abnormal circumstances where the input voltage is less than 170V or higher than 270V, the electric pump will enter the protection state and stop, and report an electrical fault and the panel will display the fault code, so as not to operate beyond the range and cause damage; and when the voltage returns to 170V-270V, and the electric pump will resume running	
Phase loss protection	When the phase loss fault occurs to the electric pump, the electric pump will attempt to restart, and restart every 1s; when attempting to restart, the electric pump reports an electrical error and the panel displays a fault code; finally, the pump will stop after 5 cycles of restart	
Overcurrent (short circuit) protection	When such faults as short circuit or overheating occur to the electric pump, the electric pump will attempt to restart, and restart every 5s; when attempting to restart, the electric pump reports an electrical error and the panel displays the fault code	
Dry running protection	When the water pump runs without water for 1 minute, the water pump will stop and report a fault, and restart after 10 minutes; finally, the pump will stop after 5 cycles of restart.	
Over-temperatu re protection	When the power module is overheated, the water pump stops and reports a fault code	



# Appendix A: Wiring

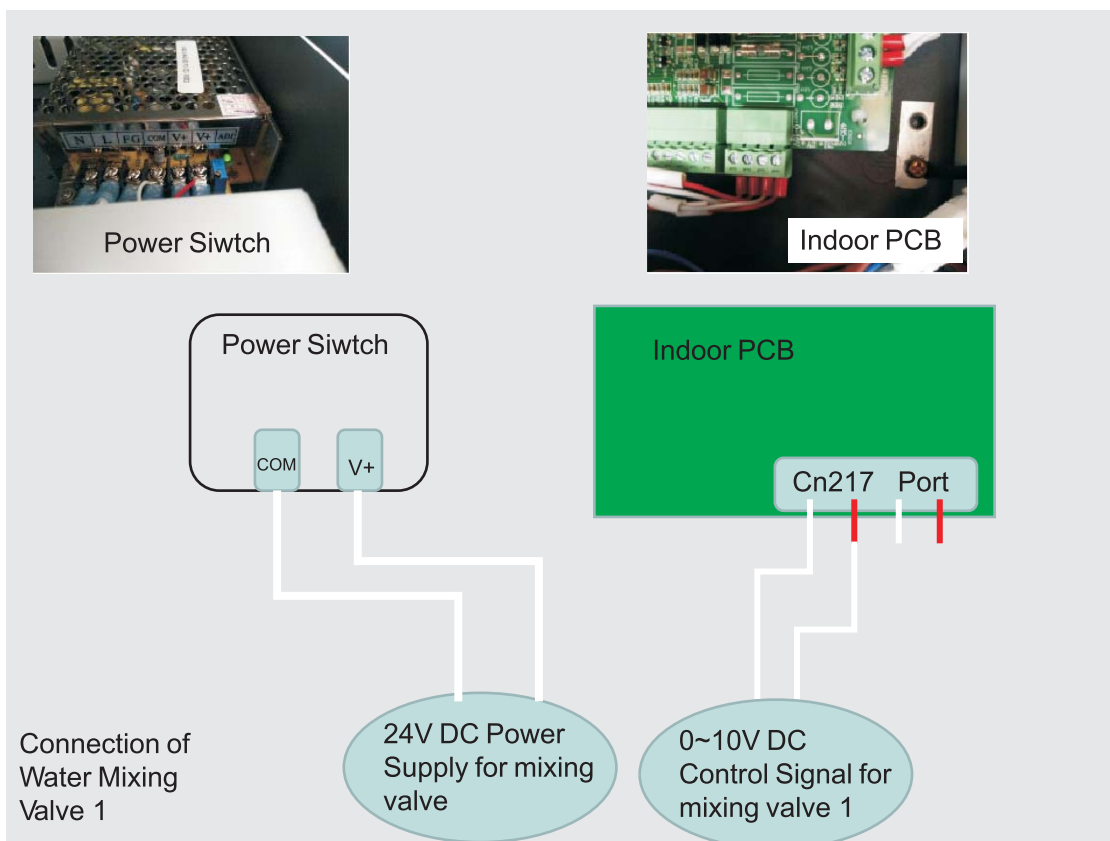
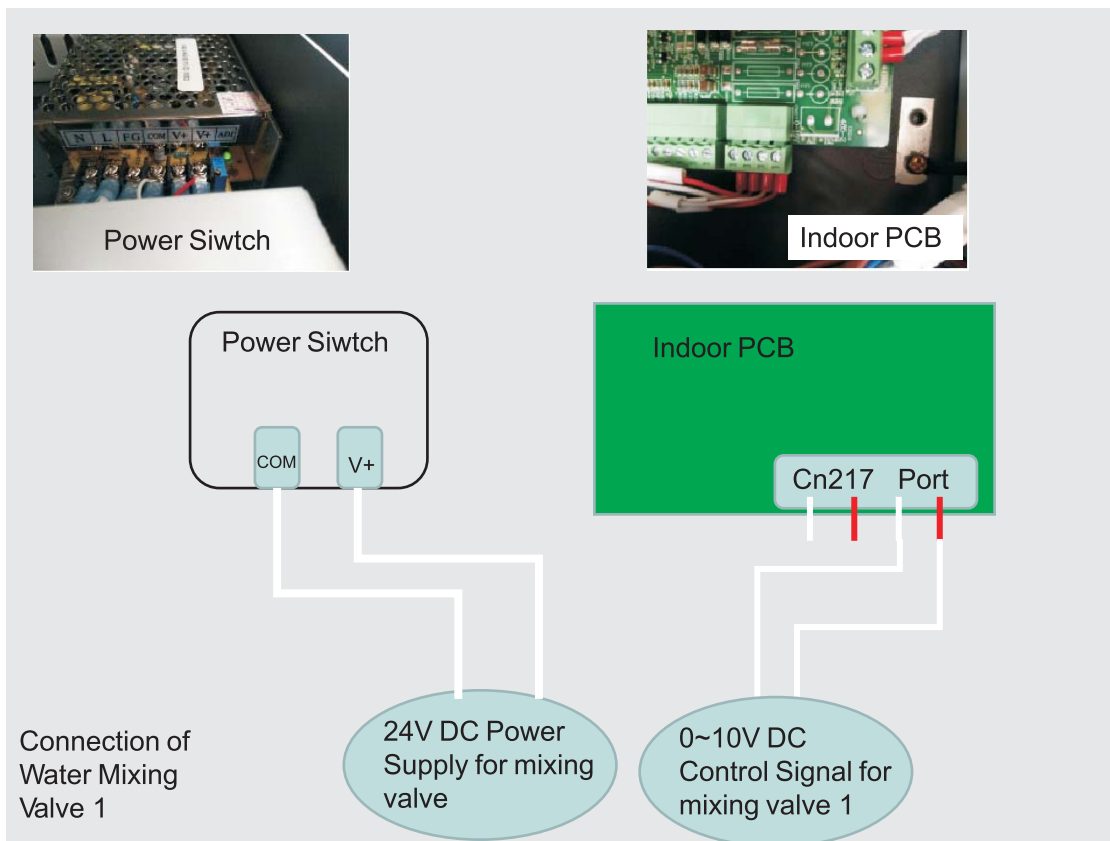

# Appendix A: Wiring

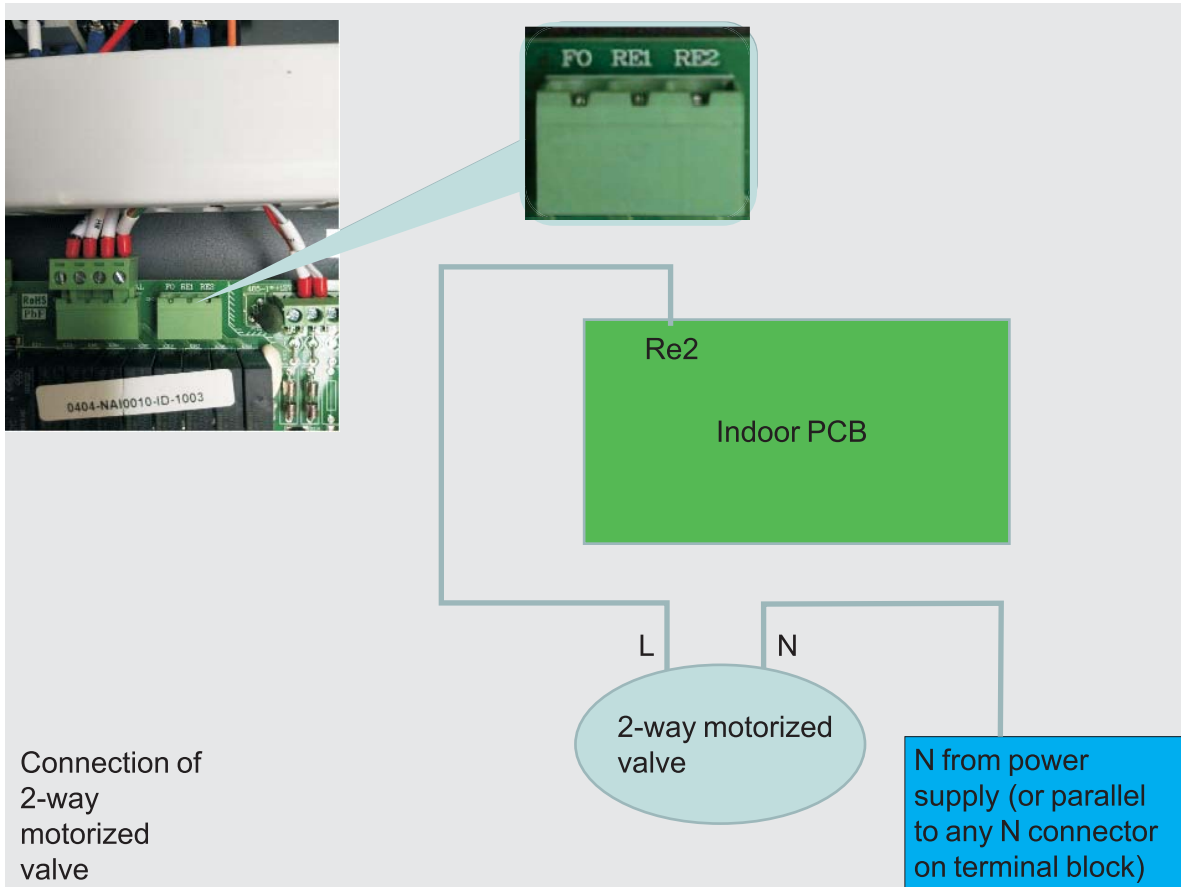

# Appendix B: Wiring

## Split indoor unit — AWST6/12-R32-S-V8

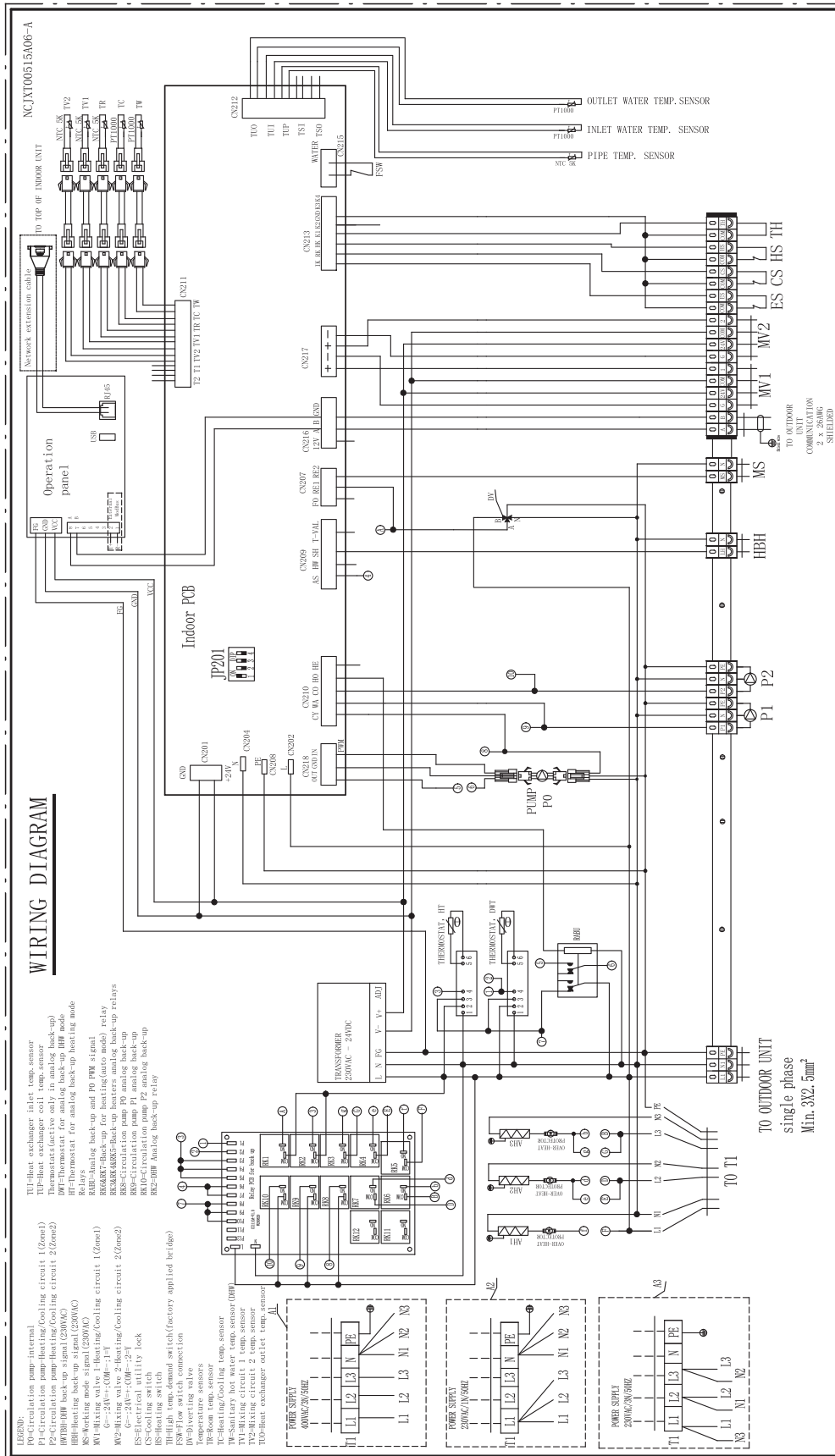

# Appendix B: Wiring

## Split outdoor unit — AW6/9/12-R32-S-V8

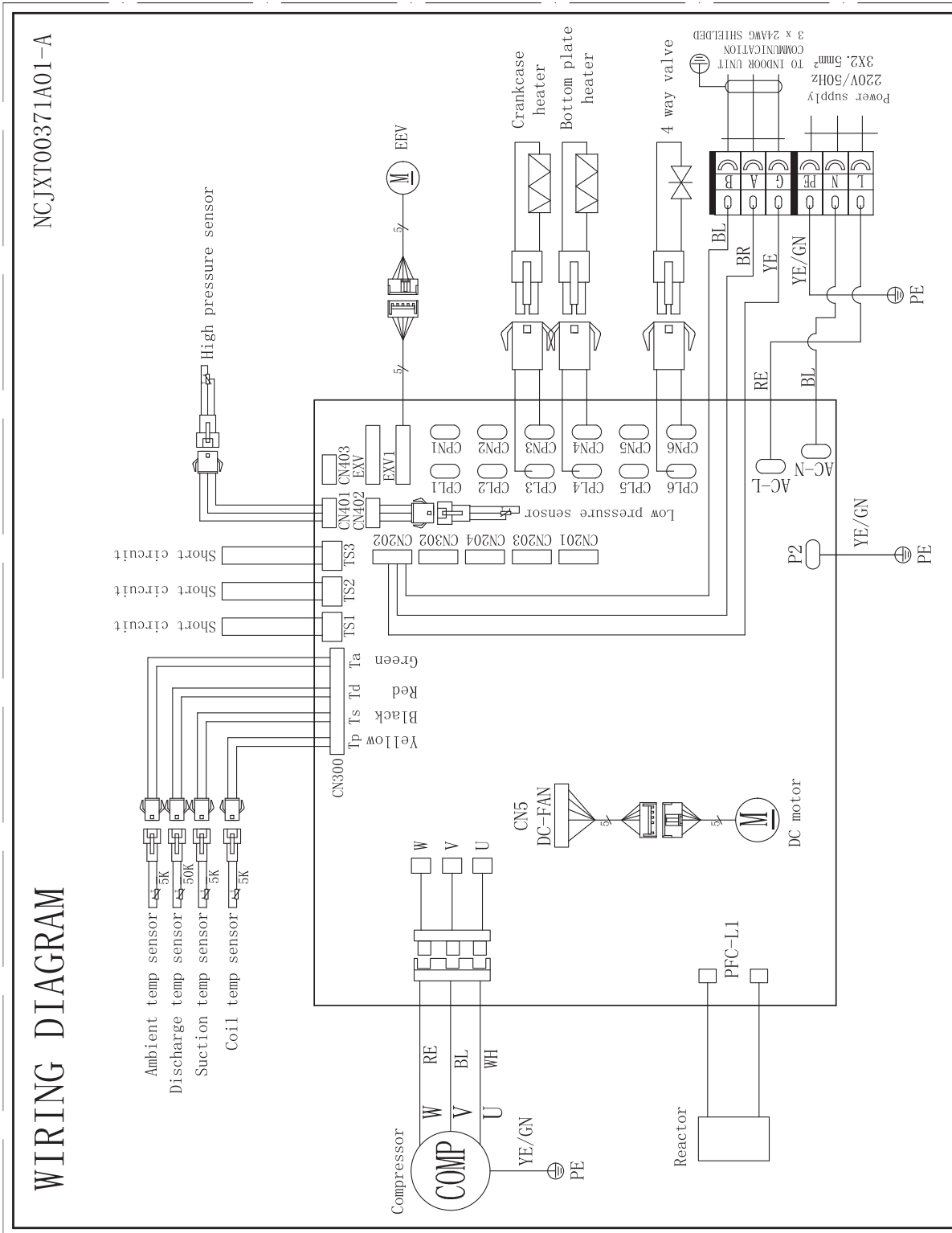

**TAKE CARE!**  
 The specifications are subject to change without prior notice.  
 For actual specifications of the unit, please refer to the specification stickers on the unit.



ES Heat Pumps AB, 44138 Alingsås, Sweden  
info@energysave.se  
www.energysave.se

Thank you for purchase of our quality product.  
Please read this manual thoroughly before use , and  
follow the instructions carefully in operating the unit  
in order to prevent damages to either the device or persons.

Product specifications are subject to change with improvements ,  
without prior notice. Please refer to the specification sticker on  
the unit for the most recent specifications.

Please refer to the contact information  
below for technical support and enquiries:

**E-mail:**

**Telephone:**