

VRF

Commercial Air Conditioners



Service Manual

Touch Screen Centralized Controller 6.2-inch



CCM-180A/WS

Content

1 General Safety Precautions	2
1.1 General	2
1.2 Installation Site.....	2
1.3 Electrical.....	2
2 Packing List	4
2.1 Specifications	4
3 Installation Procedure.....	5
3.1 Mounting the Controller	5
3.2 Centralized Controller Wiring Diagram	7
3.3 Debugging the Centralized Controller.....	8
4 Getting Started	9
4.1 Home Page Button and Display Description.....	9
4.2 Control Page	12
4.3 Schedule Page Description	19
4.4 Fault Report Page	24
4.5 Installation Interface.....	27
4.6 Settings Page	30
4.7 Help Interface.....	42





1 General Safety Precautions

Please read these general safety precautions carefully before installing the CCM-180A/WS.

After completing the installation, make sure the power supply and CCM-180A/WS operate properly during the startup operation.

1.1 General



If you are not sure how to install or operate CCM-180A/WS, contact your dealer.

	<p>NOTICE</p> <p>Improper installation or attachment of equipment or accessories could result in electric shock, short-circuit, leaks, fire or other damage to the equipment. Only use accessories, optional equipment and spare parts made or approved by Midea.</p>
	<p>WARNING</p> <p>Make sure installation, testing and applied materials comply with the applicable legislation.</p>
	<p>CAUTION</p> <p>Wear adequate personal protective equipment (protective gloves, safety glasses,...) when installing, maintaining or servicing the system.</p>
	<p>WARNING</p> <p>Tear apart and throw away plastic packaging bags so that nobody, especially children, can play with them. Possible risk: suffocation.</p>

1.2 Installation Site

Do NOT install the equipment in a potentially explosive atmosphere.

1.3 Electrical

	<p>DANGER: RISK OF ELECTROCUTION</p> <ul style="list-style-type: none"> ■ Turn OFF all power supply before connecting electrical wiring or touching electrical parts. ■ Disconnect the power supply for more than 1 minute, and measure the voltage at the terminals of main circuit capacitors or electrical components before servicing. The voltage must be less than 50 V DC before you can touch electrical components. For the location of the terminals, see the wiring diagram. ■ Do NOT touch electrical components with wet hands. ■ Do NOT leave the equipment unattended when the service cover is removed.
	<p>WARNING</p> <p>A main switch or other means for disconnection, having a contact separation in all poles providing full disconnection under overvoltage category III condition, shall be installed in the fixed wiring.</p>
	<p>WARNING</p> <ul style="list-style-type: none"> ■ Only use copper wires. ■ Make sure the field wiring complies with the applicable legislation. Do NOT touch electrical components with wet hands. ■ All field wiring must be performed in accordance with the wiring diagram supplied with the product. ■ Make sure to install earth wiring. Do NOT earth the unit to a utility pipe, surge absorber, or telephone earth. Incomplete earth may cause electrical shock. ■ Make sure to use a dedicated power circuit. NEVER use a power supply shared by another appliance.





- Make sure to install the required fuses or circuit breakers.
- Make sure to install an earth leakage protector. Failure to do so may cause electric shock or fire.

Note: Install the wires at least 1 meter away from televisions or radios to prevent interference. Depending on the radio waves, a distance of 1 meter may not be sufficient.

**WARNING**

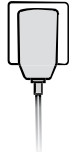
- After finishing the electrical work, confirm that each electrical component and terminal inside the electrical cabinet is securely connected.
- Make sure all covers are closed before starting up the units.

2 Packing List

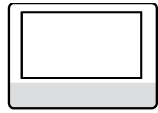
Name	Qty (specification)	Picture
Adapter	x1 (output 12V DC)	
Manual	x1	
Cable tie	x1	
Screw	x4 (ST3.9*16)	
Centralized controller	x1	

2.1 Specifications

Table 1 Specifications

Adapter	Input (AC)	100-240V, 50/60Hz, 800mA
	Output (DC)	12.0V, 2A
Centralized controller	Input voltage	12VDC
	Ambient Temperature	23~110°F (-5~43°C)
	Ambient Humidity	RH40%~RH90%
	Dimensions (mm)	181x124x30

3 Installation Procedure

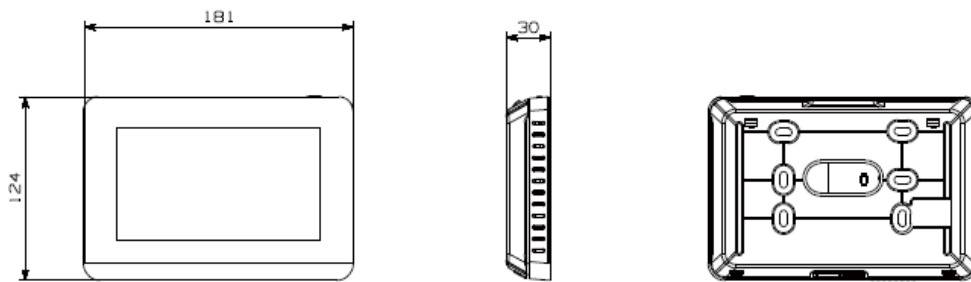

Figure 1 Front view and back view of the centralized controller (unit: mm)

3.1 Mounting the Controller

3.1.1 Remove the back cover from the controller using a Phillips-head screwdriver. See Figure 2.

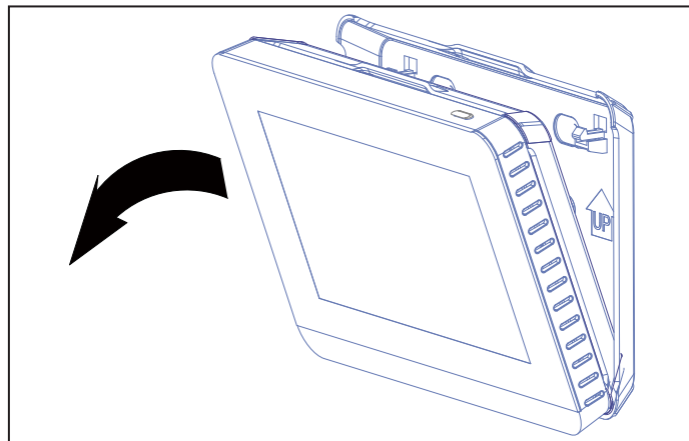

Figure 2 Remove back cover from controller

3.1.2 Attach the back cover to the wall using screws. See Figure 3.

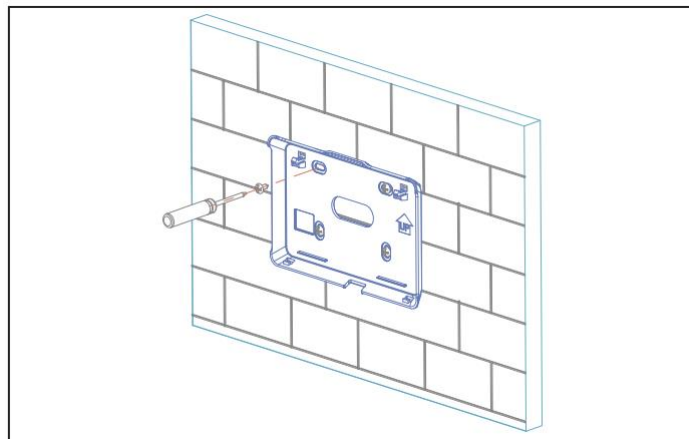

Figure 3 Attach back cover to wall

3.1.3 This product adopts a concealed installation mode. The communication cable and power cord are fixed to the positions shown in Figure 4 using cable ties.

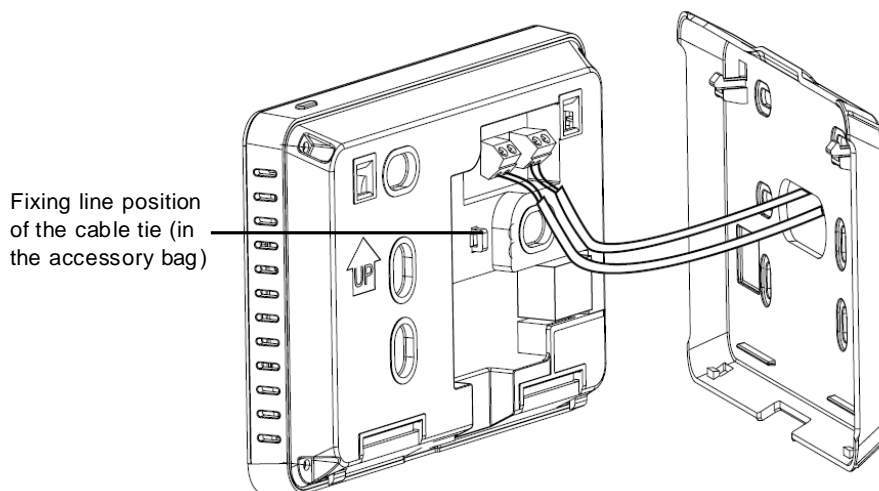

Figure 4 Centralized controller wiring diagram and cable tie fixing hole

3.1.4 Insert the centralized controller into two buckles slantwise at the bottom of back cover, as shown in Figure 5.

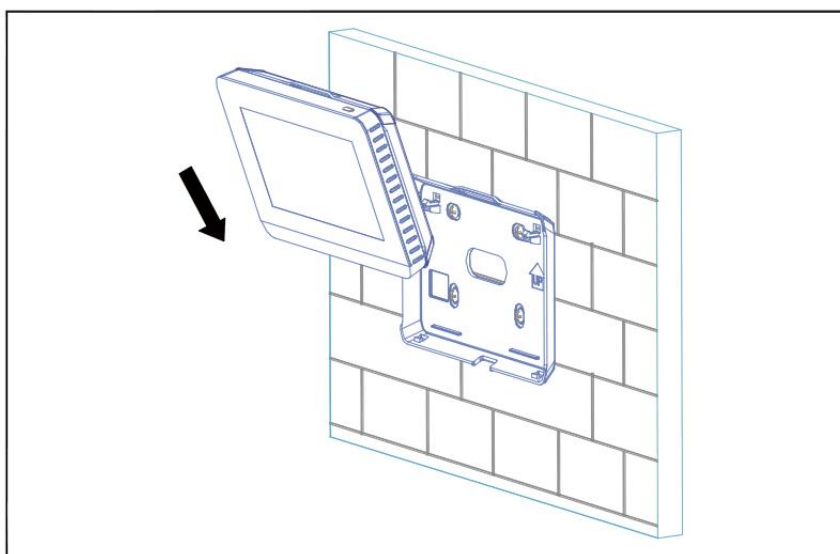

Figure 5 Insert controller into back cover

3.1.5 Press the upper part of the centralized controller into the back cover, so it gives a click sound , as shown in Figure 6.

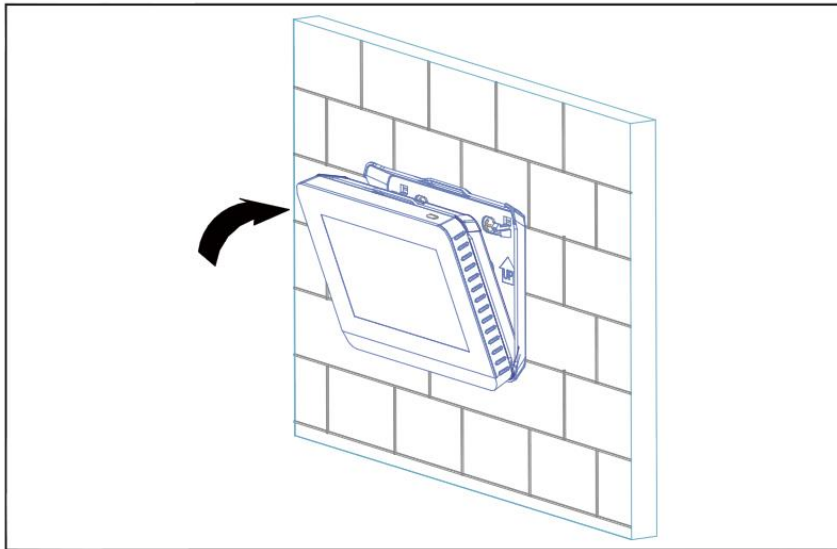

Figure 6

3.2 Centralized Controller Wiring Diagram

This centralized controller can connect to up to eight refrigerant systems and control up to 64 IDUs. Automatic addressing needs to be set for the ODU main board according to the manual.

Connect the centralized controller to the XY terminal of the communication board of the ODU through the shielded wire using the method shown in Figure 7(a).

Alternatively, connect the XY terminal of the centralized controller to the XY terminal of the first-generation AC/DC IDU, as shown in Figure 7(b).

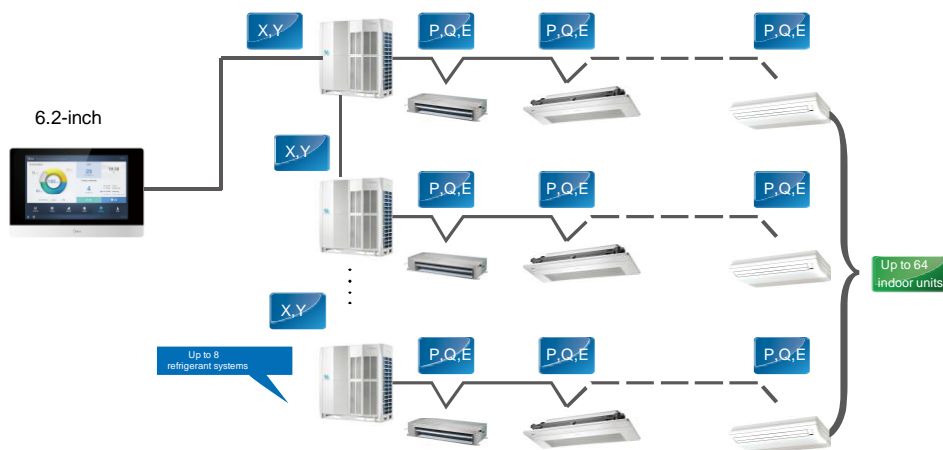

Figure 7(a) Connecting the centralized controller to the ODU



Figure 7(b) Connecting the centralized controller to the IDU (the first generation of AC/DC IDU)

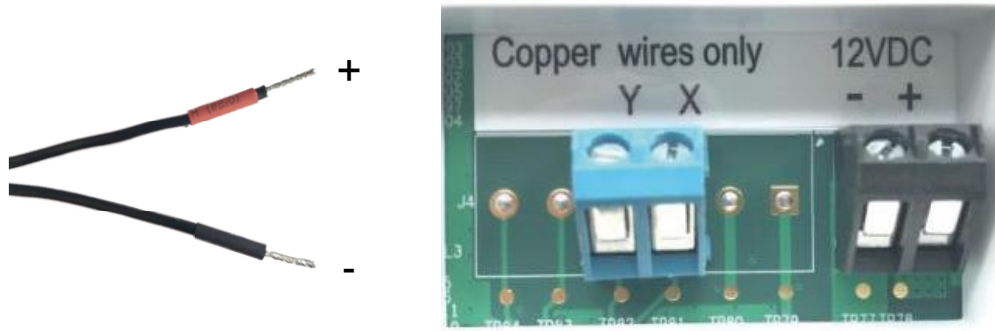

Figure 7(c) Adapter outlet terminal (12 VDC) shown in the left figure has a red positive pole and black negative pole. Connect it to the corresponding wiring terminal on the centralized controller back

3.3 Debugging the Centralized Controller

The technician installing the products needs to perform debugging. For the detailed steps, **see section 4.5.**

Note: The centralized controller will automatically search for connected devices when it is powered on for the first time. If other devices are used later, they must be searched for again on the installation interface.

4 Getting Started

4.1 Home Page Button and Display Description

This section includes the descriptions for login page and home page and provides the instructions related to these two pages.



Figure 8

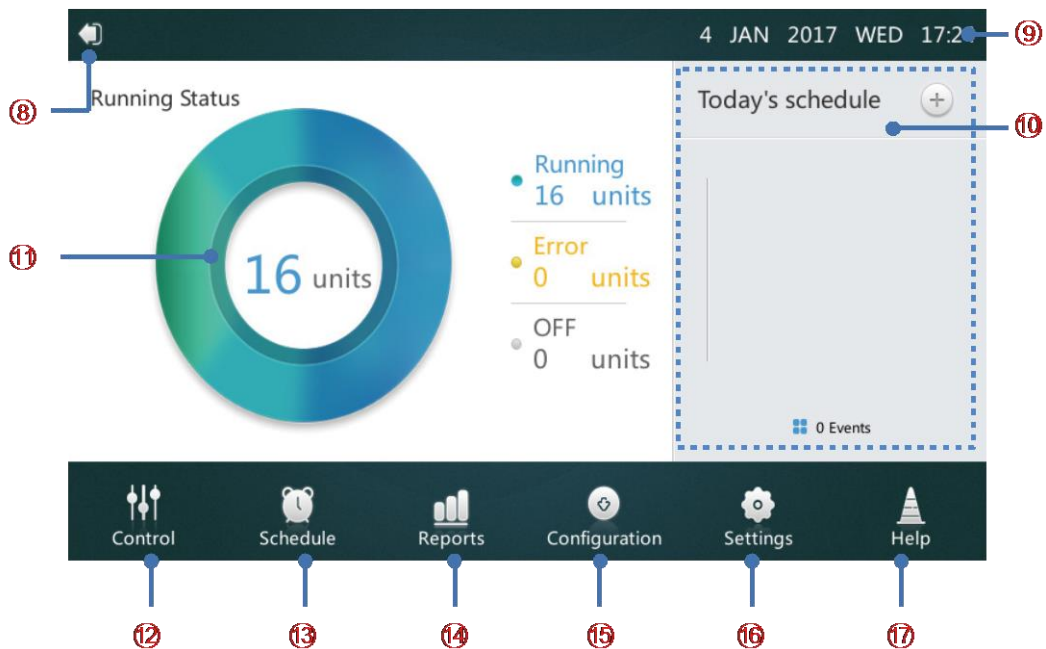

Figure 9

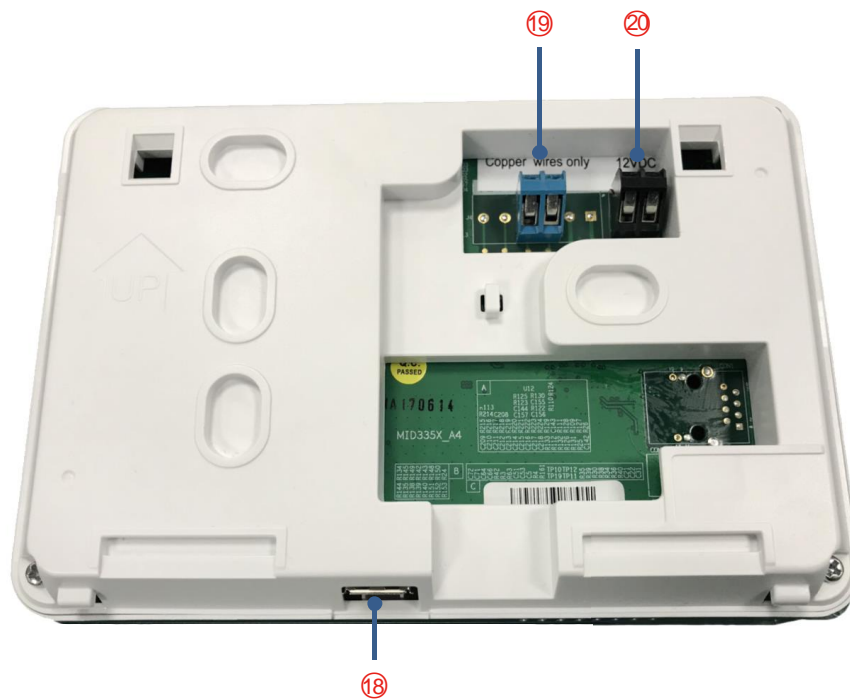

Figure 10

Table 2 Home Page Button and Display Description

NO.	Button and Display	Description
1	Screen ON/OFF button	Turn the Screen on/off
2	Username	Enter login username
3	Password	Enter login password
4	Save Password	Enable/disable the automatic login password saving function
5	Auto-login	Allow automatic login after powering on again
6	Login	Login
7, 18	USB2.0 socket (at the bottom of centralized controller)	Externally connecting to the USB storage device to provide the software upgrading and error code exporting functions
8	Logout	Back to login page
9	Date and Time	Display date and time
10	Today's Schedule	Display the list of schedules
11	Advanced information of IDU and ODU	Display the IDU and ODU spot inspection parameters
12	Control menu	Enter the control page
13	Schedule menu	Enter the schedule page
14	Reports menu	Enter the report page
15	Configuration menu	Enter the configuration page
16	Settings menu	Enter the setting page
17	Help menu	Enter the help page
19	Communication terminal	Connect to the control device through the XY shield line
20	Power supply terminal	Connect to the 12VDC adapter

4.1.1 Login

1. Power on the centralized controller.
2. Enter the user name and password on the login interface and tap the Login **button**.

Note: 1. For users, the technician will provide the user name and password to you .

2. For technicians, please use the administrator account to debug the controller. The default account name is "**admin**", password is "**123456**".

3. After you tap to save the password and select automatic login, the centralized controller will log in to the home interface automatically. It will then skip the login interface after it is powered on each time.

4.1.2 Logout

Tap the icon marked "8" in the top left corner of the home page to exit the login interface.

4.1.3 Turning on the Screen

If the user does not touch the interface for a long time after login, the screen backlight will turn off automatically. The user can press the on/off button "1" on the top of the centralized controller or tap any position on the screen to turn on the screen.

4.1.4 Turning off the Screen

After login, press the on/off button marked "1" on the top of the centralized controller to turn off the screen backlight or set the automatic off time for the backlight in general settings.

4.2 Control Page

This section describes the functions and operations of the Control page.

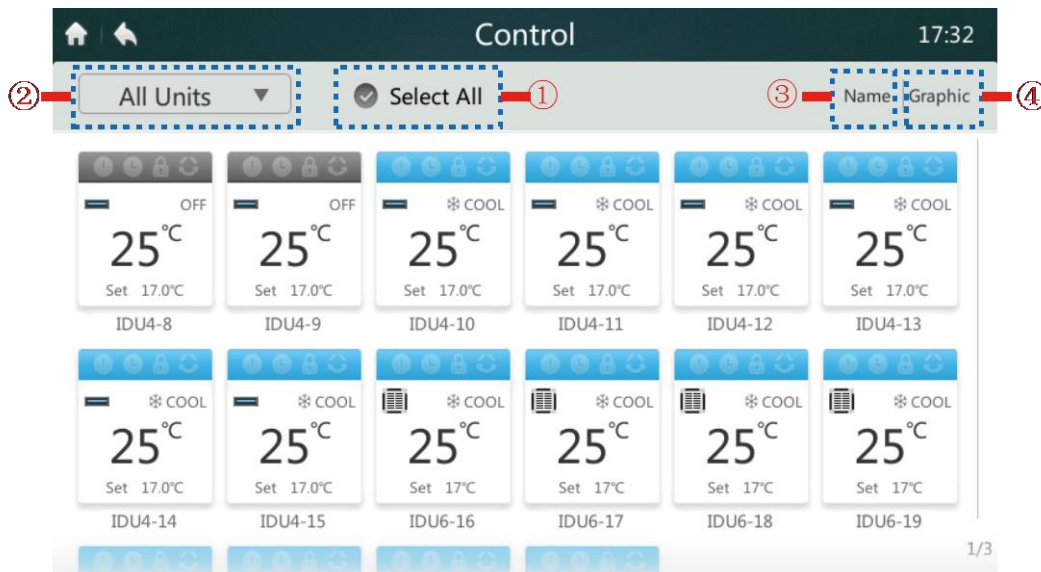

Figure 11 Homepage 1 of the Control Page

4.2.1 Select/Deselect All IDUs

Tap the "Select All" position marked "1" in Figure 11. If the tick is displayed in blue, all the IDUs are selected. Tap the "Select All" position. The tick changes to gray, indicating that no IDU is selected.

4.2.2 Choosing IDU Group

Tap the position marked "2" in Figure 11 to open the drop-down menu, as shown below. Select the set IDU group for group control. Group editing is detailed on the installation interface in section 3.5.

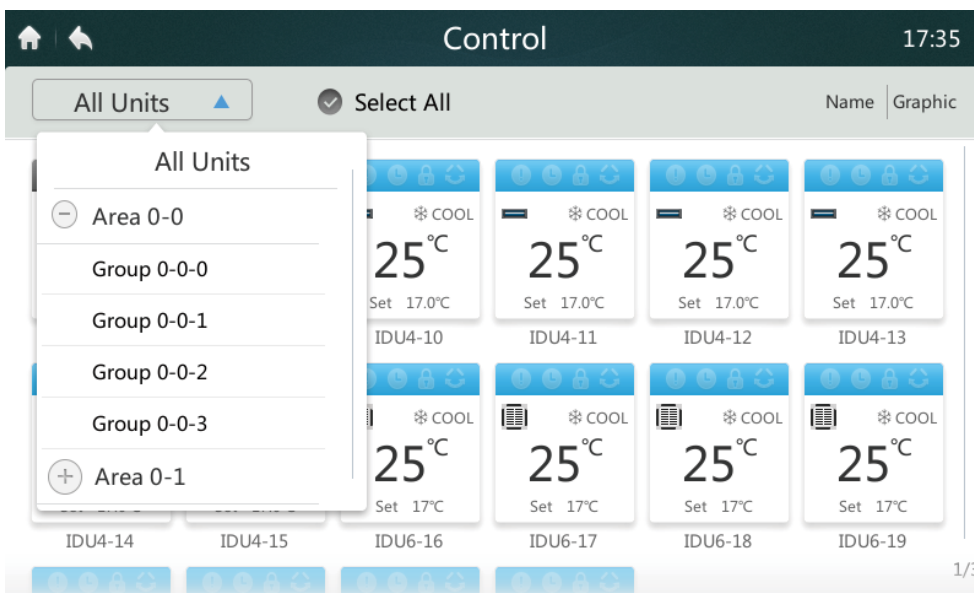

Figure 12

4.2.3 Sorting IDUs in Order

Tap the position marked "3" in Figure 11, as shown in the following figure. You can select whether to sort the IDUs by name, operating mode or model.

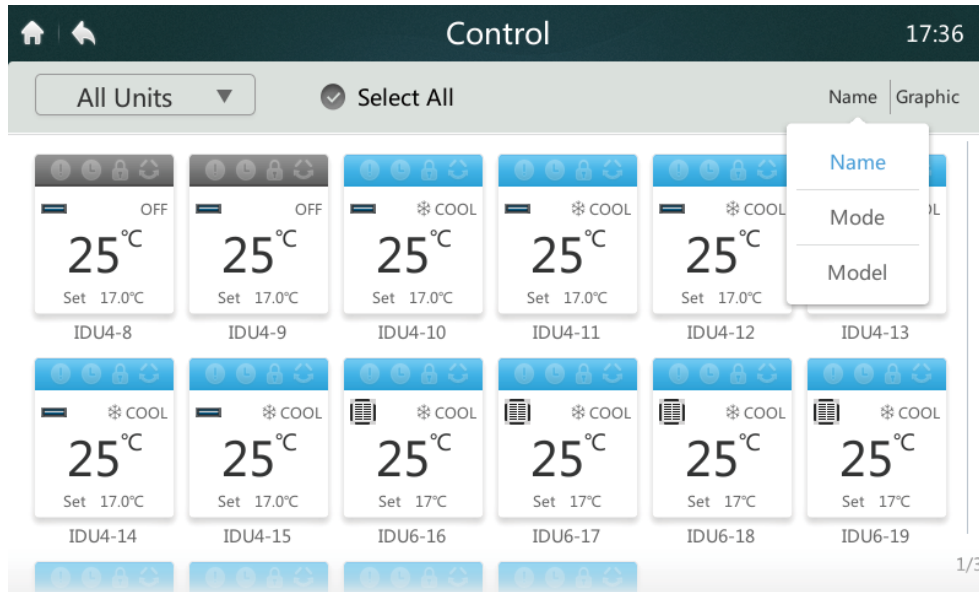

Figure 13

4.2.4 Setting the IDU Display

Tap the position marked "4" in Figure 11. The display mode can be switched to icon (as shown in Figure 11) or list (as shown in the figure below). For the list display mode, only the status parameters of the IDU can be viewed. Table 3 provides the parameter abbreviations and corresponding description. IDUs can be selected for operations on in the icon display mode.

IDU	Mode	Temp.	Fan Speed	Swing	Lock	Lower	Upper	--
IDU4-8	OFF	17°C	OFF	OFF	OFF	-	-	-
IDU4-9	OFF	17°C	OFF	OFF	OFF	-	-	-
IDU4-10	COOL	17°C	1	OFF	OFF	-	-	-
IDU4-11	COOL	17°C	1	OFF	OFF	-	-	-
IDU4-12	COOL	17°C	1	OFF	OFF	-	-	-
IDU4-13	COOL	17°C	1	OFF	OFF	-	-	-
IDU4-14	COOL	17°C	1	OFF	OFF	-	-	-

Figure 14

Table 3 Displayed parameter description of Control page list

No.	Parameter	Description
1	IDU	Device name
2	Mode	Current operating mode
3	Temp.	Current set temperature
4	Fan Speed	Current fan speed
5	Swing	Swing switch

6	Lock	Locking switch
7	Lower	Lower limit of cooling temperature
8	Upper	Upper limit of heating temperature

IDU icon

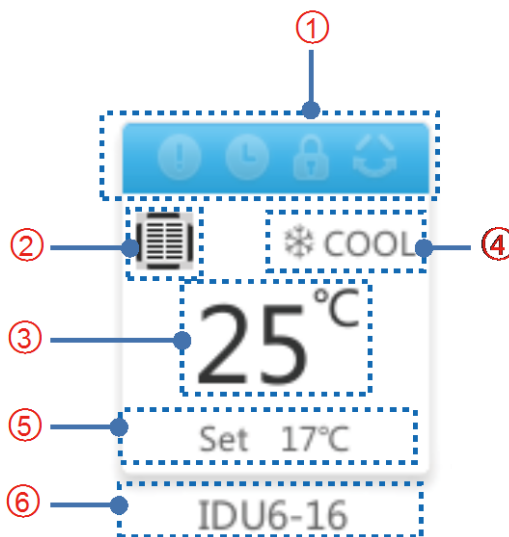

Figure 15

Table 4 icon function description of Control page

Mark	Function	Description
1	Operation Mode and Device Status Icon	The icon changes according to different operating modes and IDU statuses (refer to Table 5).
2	Model icon	The icon will change according to the model (refer to Table 6). The icon may be different from the actual appearance.
3	Room Temperature	Display the indoor temperature.
4	Operation Mode	Display the operating mode of the IDU.
5	Set temperature	Display the set temperature (Note: In auto mode, the autocoooling temperature is displayed in the cooling status, and the auto heating temperature is displayed in the heating status)
6	IDU name	Display the device name

Table 5 Operating mode, status and corresponding color

Color	Operation Mode
Blue	AUTO (automatic)
Red	HEAT (heating)
Green	FAN (air supply)
Light blue	COOL (cooling)
Purple	DRY (dehumidifying)
Gray	ERROR/OFFLINE/OFF



















IDU function description and icon	Invalid	Valid
Fault 	Off	On
Schedule 	Off	On
Lock 	Off	On
Swing 	Off	On

Table 6 Icons and corresponding models

Icon	Model	Icon	Model
	Low static pressure and middle static pressure (L-DUCT/M-DUCT)		Vertical concealed installation/vertical surface mounting (FS)
	High static pressure (H-DUCT)		Four-way Cassette
	Purifier (FAPU)		Compact Four-way Cassette (COMPACT)
	Wall mounting (WALL)		Ceiling-floor type (C&F)
	Old IDU (1st Gen. IDU)		Two-way Cassette
	One-way Cassette		CONSOLE
	Group control device icon		New ODU (New generation ODU)

4.2.5 Turning IDUs on/off

Tap the "  " icon to power the system on/off in the area marked "1" in Figure 16.

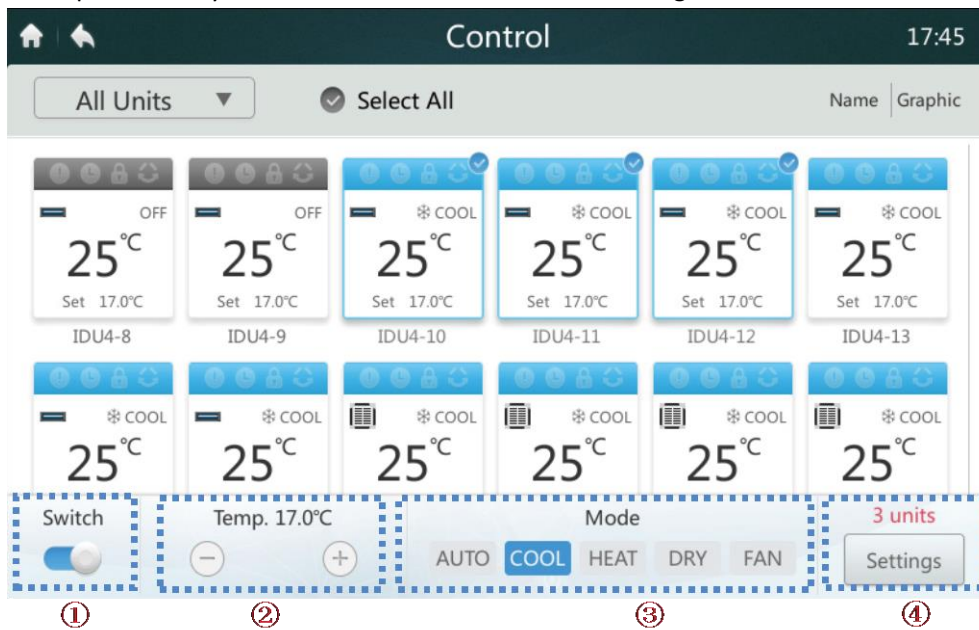



Figure 16 Homepage 2 of the Control page

4.2.6 Setting the Temperature

Tap the "  /  " button of the icon marked "2" in Figure 16 to increase or reduce the set temperature of the IDU in the range of 17°C to 30°C (62°F to 86°F).

Note: The centralized controller automatically identifies whether the connected system is in auto mode. If yes, two temperature points will be displayed. If no, only one temperature point is available, as shown in the above figure.

4.2.7 Setting Mode



Directly tap the area marked "3" in Figure 16. Select one of the five modes.

Note: The centralized controller automatically identifies if the connected system is in auto mode. If yes, the auto mode button will be displayed. If no, the auto mode button will not be available. Auto mode and dry mode are not available when only the purifier is selected.

4.2.8 More Setting Options

Select an IDU. Tap the "Settings" button marked "4" in Figure 16 to enter the interface below.

4.2.9 Setting Fan Speed

Tap the "  /  " icon marked "1" in Figure 17 to increase or reduce the fan speed. Auto fan speeds 1 to 7 or high/middle/low speed is displayed according to the selected IDU.

Note: If the fan has an AC motor, 1 and 2 indicate "Low" fan speed, 3 and 4 indicate "Mid" fan speed, and 5, 6 and 7 indicate "High" fan speed.

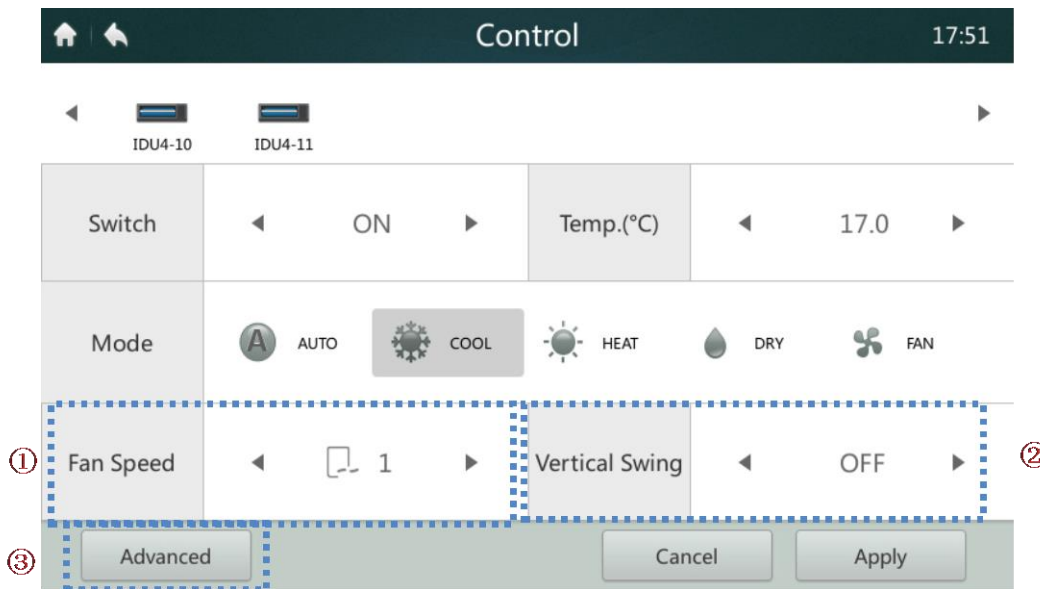

Figure 17 Settings 1 of the Control page

4.2.10 Setting Auto Swing

Tap the "◀ / ▶" icon marked "2" in Figure 17 to set the Vertical automatic swing switch.

4.2.11 Lock Control Panel

Tap the "Advanced" option marked "3" in Figure 17 to access the interface below. The locking panel function is detailed in Table 7.

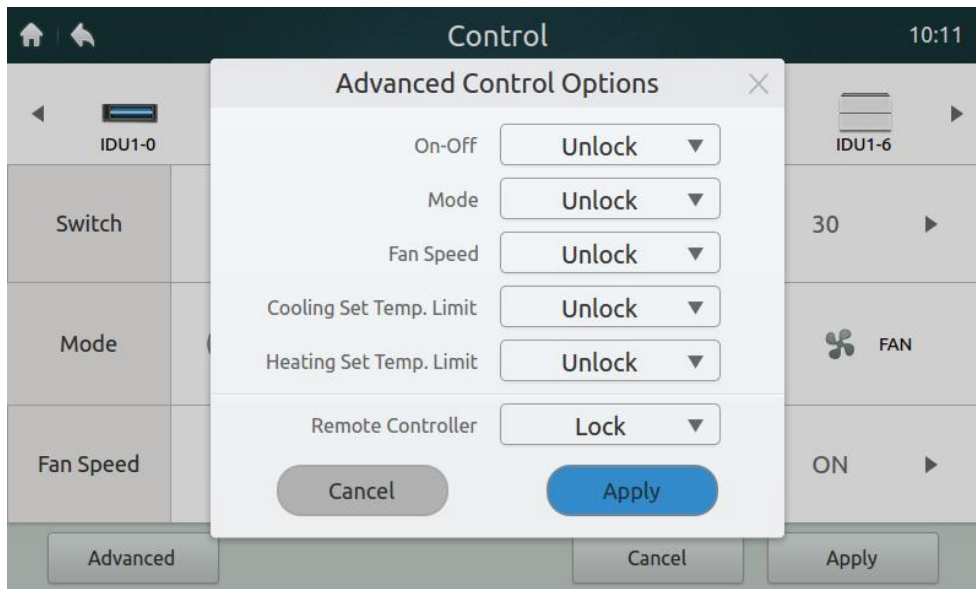

Figure 18

Table 7 Lock control panel function description

Item	Description
On-Off	[Lock-OFF] button: Disable turning on IDUs [Lock-ON] button: Disable turning off IDUs [Unlock] button: Disable the lock
Mode	[Lock] button: Disable changing mode [Unlock] button: Disable the lock
Cooling Set Temp. Limit	[17°C~30°C / 62°F~86°F] button: Set the lowest temperature limitation [17°C~30°C / 62°F~86°F]: [Unlock] button: Disable the lock
Heating Set Temp. Limit	[17°C~30°C / 62°F~86°F] button: Set the highest temperature limitation [17°C~30°C / 62°F~86°F]: [Unlock] button: Disable the lock
Remote controller	[Lock] button: Disable remote control for all features [Unlock] button: Disable the lock.

4.3 Schedule Page Description

This section provides the descriptions and instructions for the Schedule page.

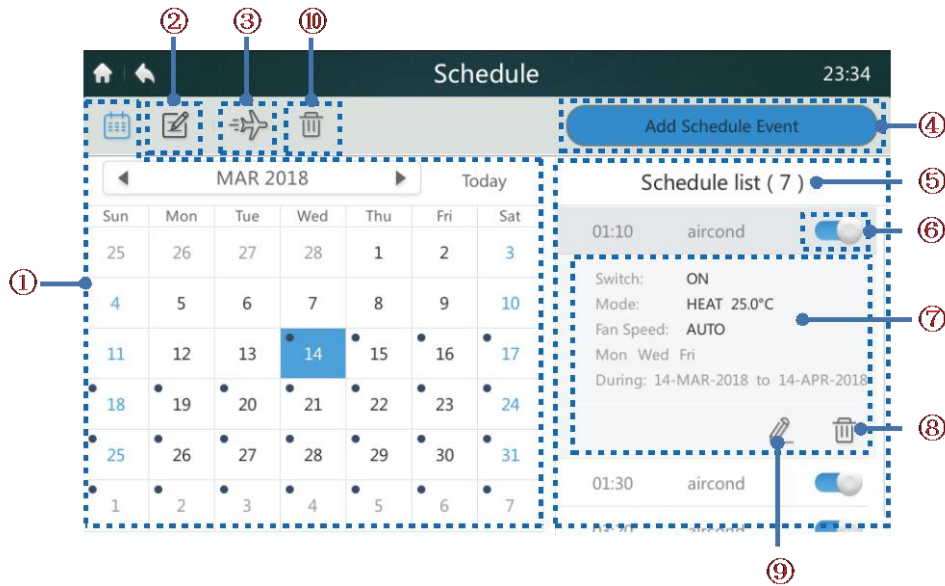

Figure 19 Homepage of Schedule page

Table 8 Schedule page icons and description

Mark	Function	Description
1	Date	Display the date. Use the [◀] and [▶] buttons to select a date. Tap any date to add a schedule. Tap the position of “today” to return to the current date quickly. AA black spot in the upper left of a date means there is a set schedule for that day.
2	Edit the schedule for the current day	Display and edit the schedule list information for the current day
3	Holiday settings	Add or edit the schedule list
4	Add Schedule Event	Create a new schedule plan
5	Schedule list	Display the schedule list and schedule information for the current date
6	Enable/disable a schedule	Enable or disable the selected schedule command
7	Schedule information	Display the schedule information
8	Delete the current schedule	Delete the current schedule
9	Edit	Edit the selected schedule
10	Delete all the schedules	Delete all the schedule settings

4.3.1 Adding a New Schedule Plan

1. Tap the add schedule button marked "4" in Figure 19 to enter the interface, as shown in Figure 20.

Figure 20 Page for adding a schedule

2. Tap the position marked "1" in Figure 20 to display the input keyboard below. Create a schedule name and tap the "Confirm" button to save the name.

Figure 21

- Tap the area marked "2" in Figure 20, and set the start time and date range, as shown in the two figures below. Tap the "Save" button to save the settings, or the "Cancel" button to cancel the settings.

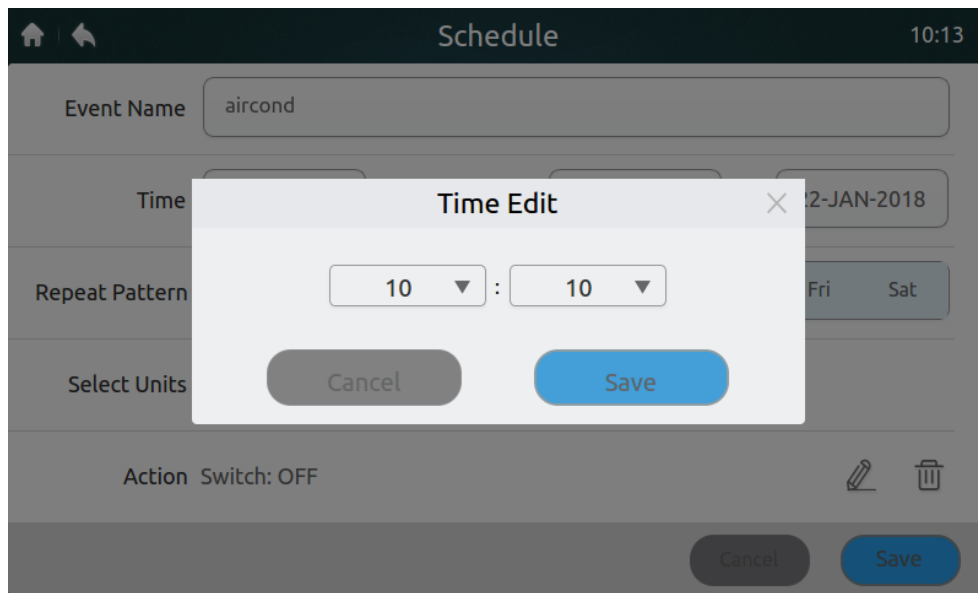

Figure 22

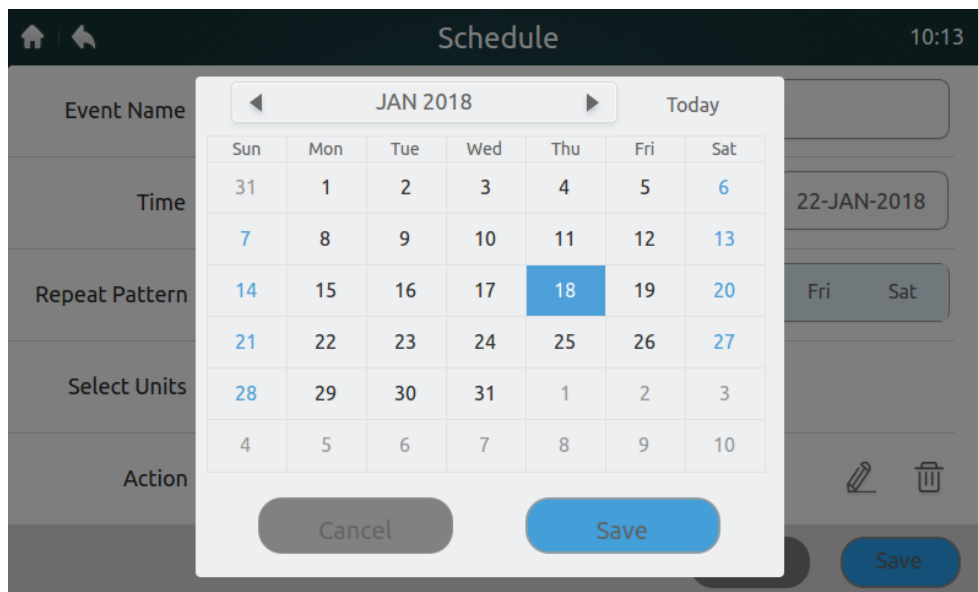

Figure 23

- At the position marked "3" in Figure 20, tap the drop-down menu next to the repeat pattern. Select "Everyday", a work day, or customize a pattern.

Note: The command is executed every day in the selected date range. Work days are in the range Monday to Friday. The customized pattern is a free combination.

- Press the "Edit Unit" button marked "4" in Figure 20 to add an IDU separately or a group to the schedule, as shown below. Tap the "Save" button to save the selected device or the "Cancel" button to cancel the selection.

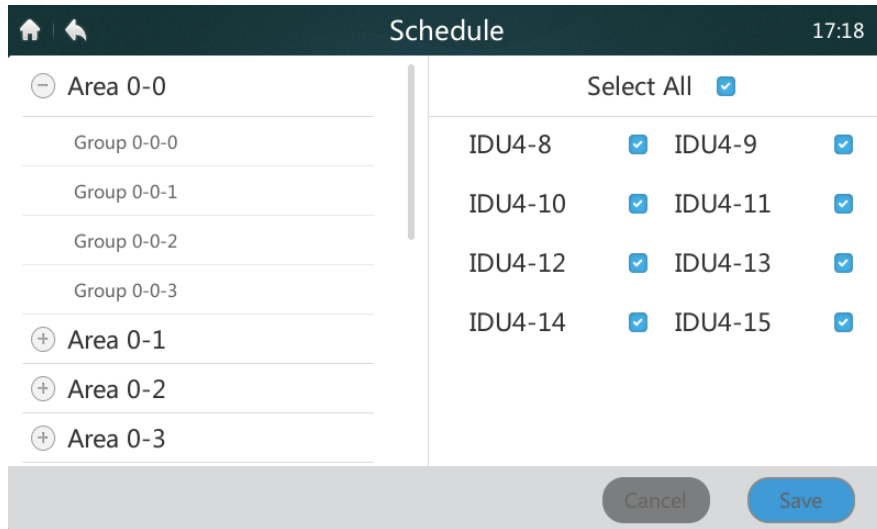



Figure 24

- Tap the “” icon, as shown in the lower right corner in Figure 20. Then set the scheduled operating mode, temperature, and fan speed, as shown below. Tap the "Save" button to save the settings, or the "Cancel" button to cancel the settings.

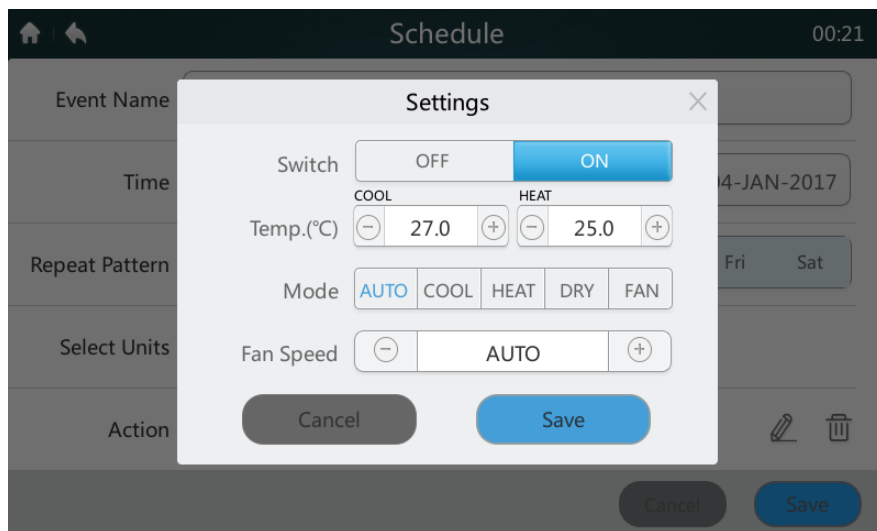

Figure 25

- Tap the "Save" button in the lower right corner of Figure 20 to save and execute the schedule or tap the "Cancel" button to cancel the save operation.

4.3.2 Creating Holiday Settings

1. Tap the "➔" button marked "3" in Figure 19 to enter holiday settings, as shown below. Schedules are not implemented during the holiday period.

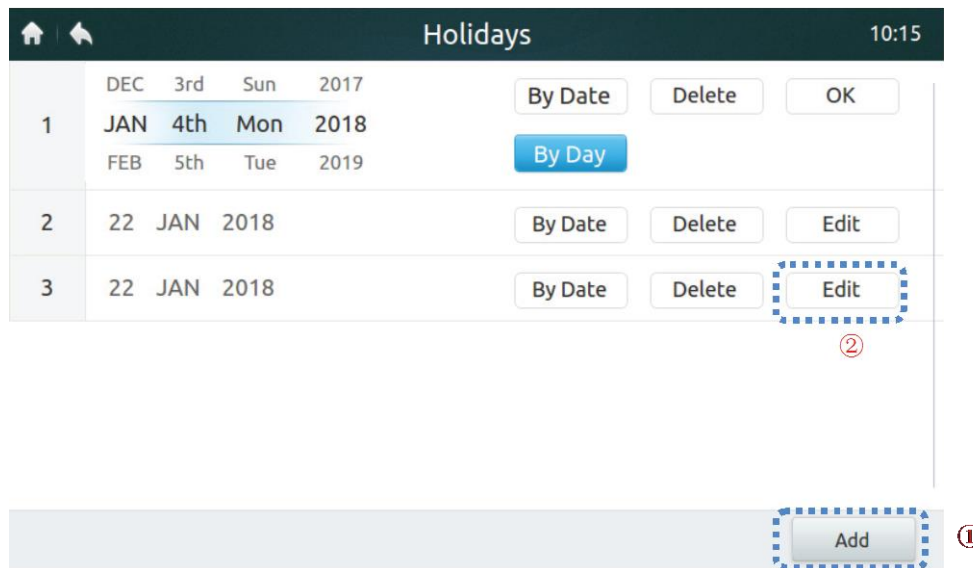

Figure 26

2. Tap the "Add" button marked "1" in the above figure.
3. Tap the "Edit" button marked "2" in the above figure.
4. Slide upward and downward to select a date.

Note: "By Date" and "By Day" are available. "By Date" means setting by month, date and year; "By Day" means setting by a day in a week of a month.

5. Tap "OK" to save the date or "Delete" to delete the date.

4.3.3 Deleting All Schedules

Tap the "🗑️" button marked "10" in Figure 19 to delete all the schedules settings. The following prompt appears, as shown below. Tap "Delete" to delete the schedule or tap "Cancel" to cancel the operation.

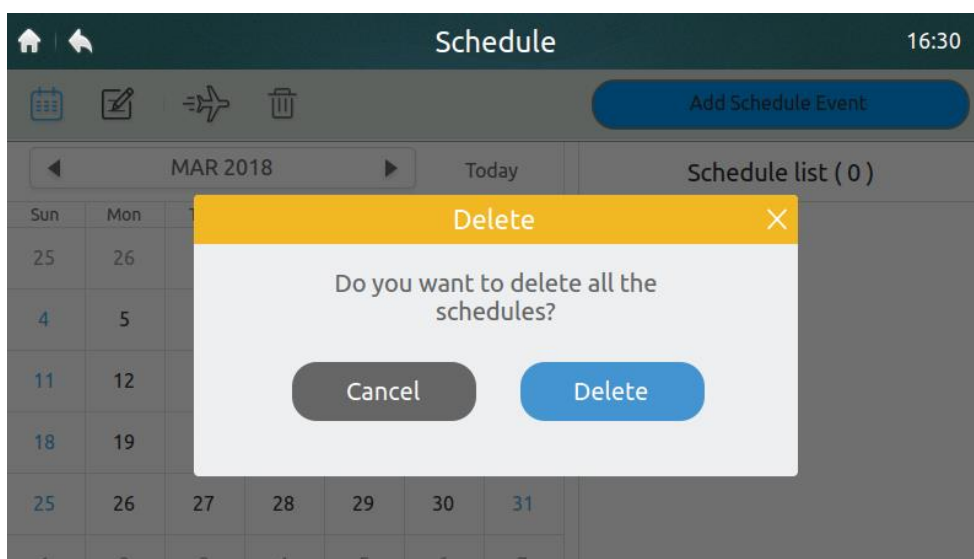

Figure 27

4.4 Fault Report Page

Only the installation technician and administrator have access permissions.

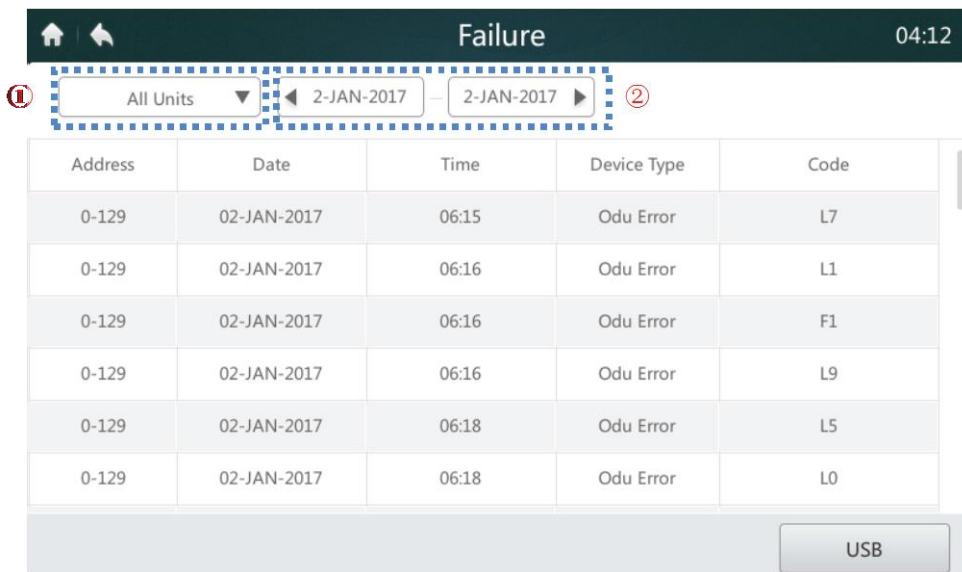

Figure 28 Homepage 1 of the Report page

1. Tap the drop-down list in the area marked "1" in Figure 28, and select the group or all the devices to be viewed.

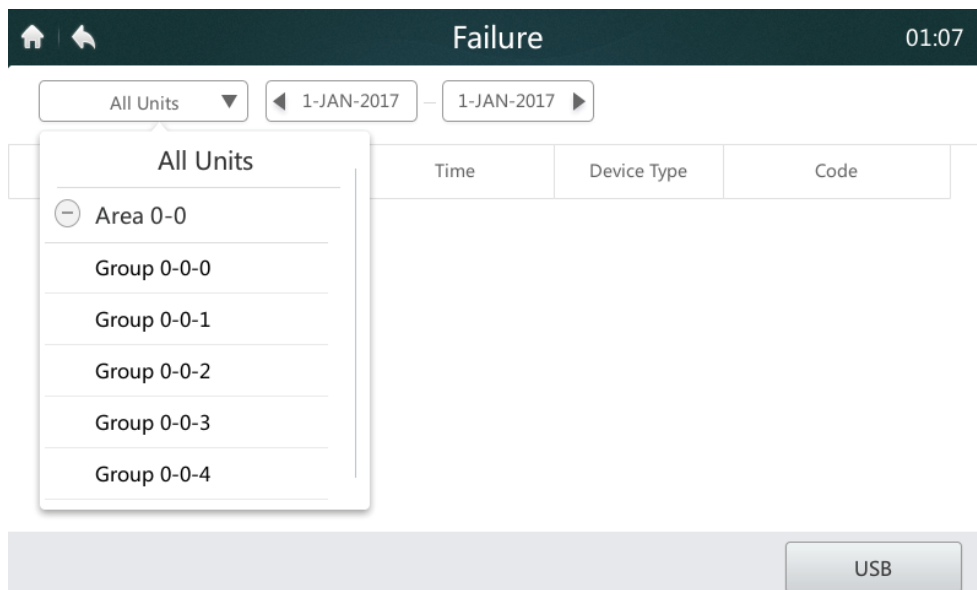

Figure 29

2. Tap the area marked "2" in Figure 28 to display the date window, as shown below. Tap the left area to select the start date. Select the end date in the right area.

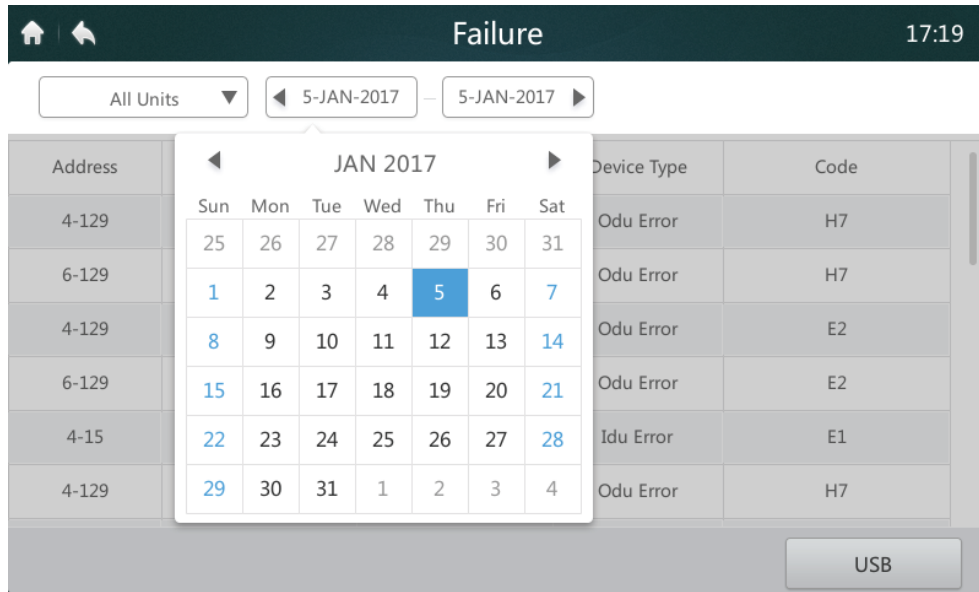

Figure 30

- If there is a historical fault record in the system after the start date and end date are selected, the interface shown in Figure 31 will be displayed.

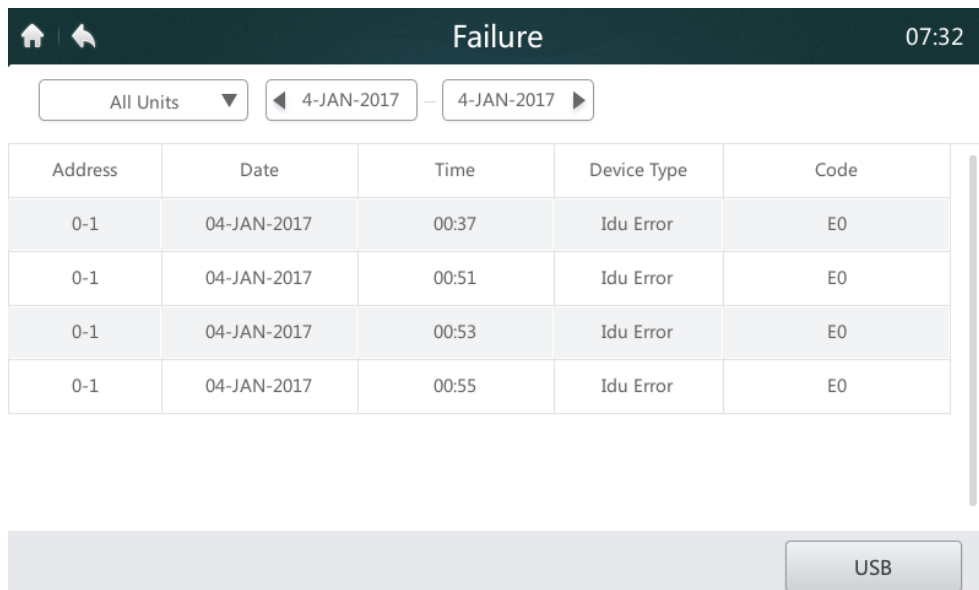

Figure 31 Homepage 2 of the Report page

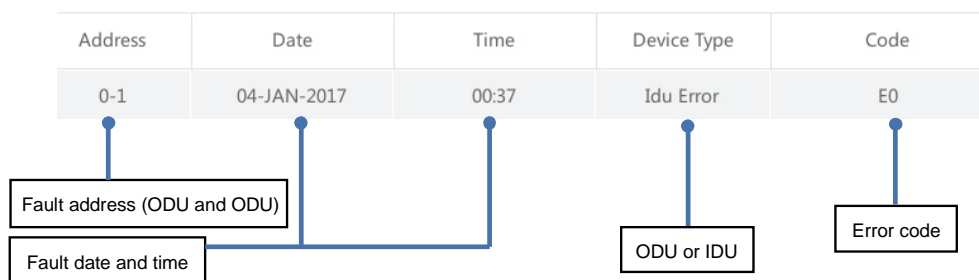

Figure 32

4. Insert the USB storage device and tap the "USB" button marked "1" in Figure 31. The fault data will be exported to the mobile device in "csv" format. The fault data content includes the address, date, time, model and error code (as shown in the above figure) to facilitate queries. The screen will display the success message after the data is exported successfully, as shown below.

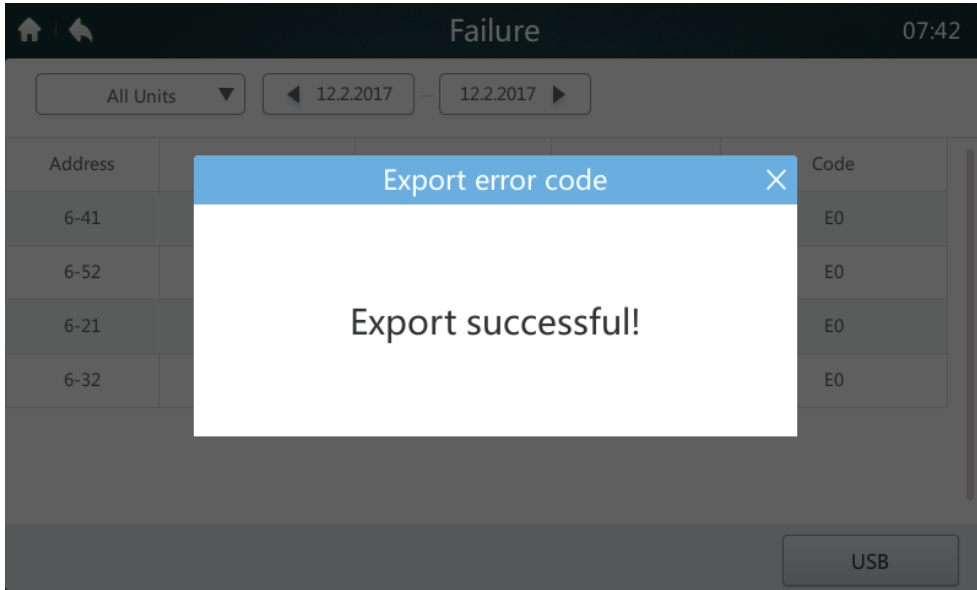

Figure 33

5. Open the exported file through Excel, as shown below:

	A	B	C	D	E
1	Address	Date	Time	Device Type	code
2	6-129	02-JAN-2017	05:33	Odu Error	"E4"
3	6-49	02-JAN-2017	05:34	Idu Error	"E2"
4	6-4	02-JAN-2017	05:36	Idu Error	"E0"
5	6-0	02-JAN-2017	05:37	Idu Error	"E0"
6	6-1	02-JAN-2017	05:37	Idu Error	"E0"
7	6-2	02-JAN-2017	05:37	Idu Error	"E0"
8	6-3	02-JAN-2017	05:37	Idu Error	"E0"
9	6-5	02-JAN-2017	05:37	Idu Error	"E0"
10	6-6	02-JAN-2017	05:37	Idu Error	"E0"
11	6-7	02-JAN-2017	05:37	Idu Error	"E0"
12	6-8	02-JAN-2017	05:37	Idu Error	"E0"
13	6-9	02-JAN-2017	05:37	Idu Error	"E0"
14	6-10	02-JAN-2017	05:37	Idu Error	"E0"
15	6-11	02-JAN-2017	05:37	Idu Error	"E0"
16	6-12	02-JAN-2017	05:37	Idu Error	"E0"

Figure 34

4.5 Installation Interface

This section describes the installation interface operations and provides instructions. Only the installation technician and administrator have operation permissions.

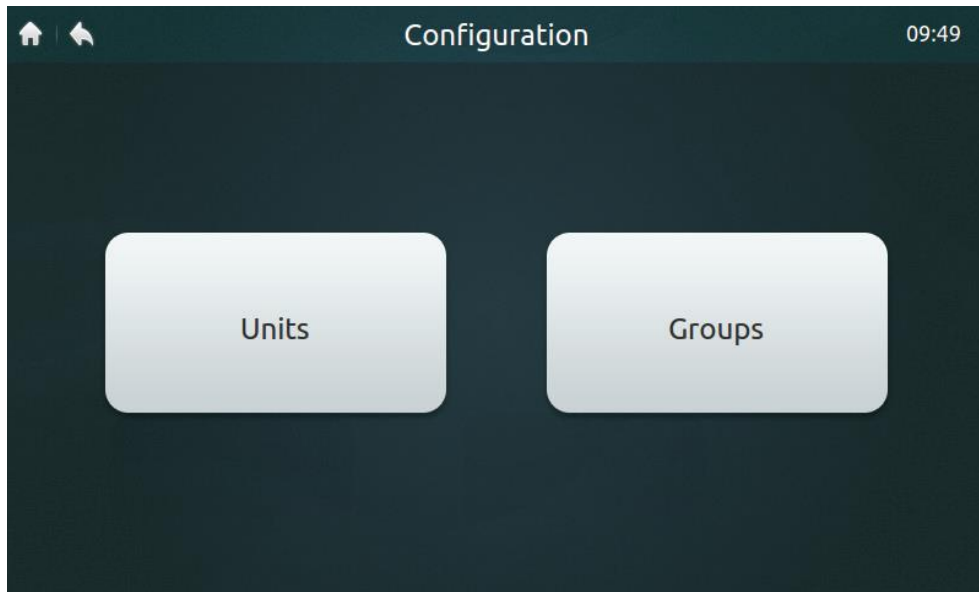

Figure 35 Homepage of Installation interface

Table 9 Setting Interface Icons and Descriptions

No.	Item	Description
1	Installation	Perform automatic searches and edit the device name
2	Group view	Query group devices and edit groups

4.5.1 Auto Searches and Naming Devices

1. Tap the "Units" button, as shown in Figure 35, to enter the interface, as shown in Figure 36.

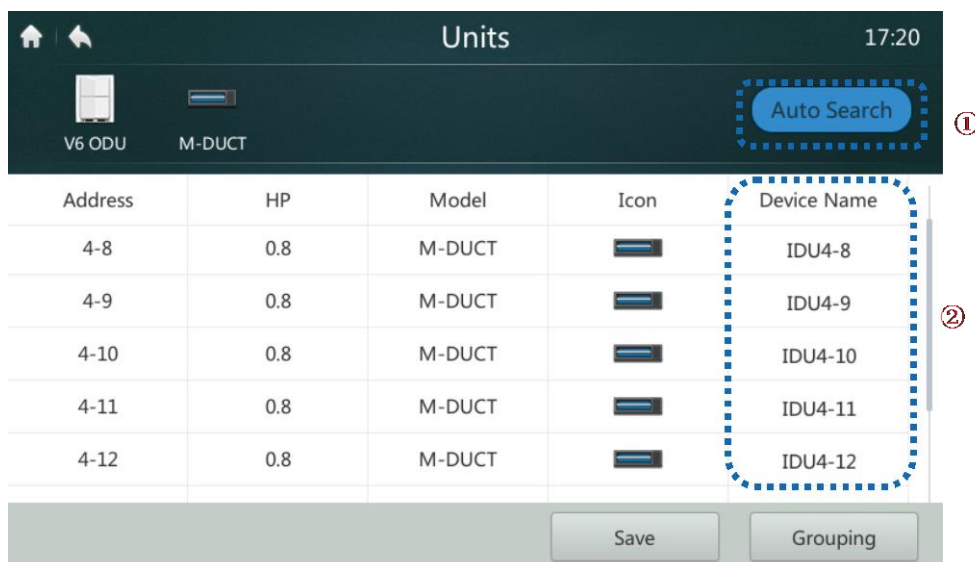

Figure 36 Device installation page

2. Tap the "Auto Search" button marked "1" in Figure 36. The connected device will be displayed on the interface. The table displays the IDU HP, IDU type (the correct type can be displayed correctly for second-generation IDUs only. Other types are first-generation IDUs), type icon (the correct type can be displayed correctly for the second-generation IDUs only. The Four-way Cassette icon is displayed for other units), and device name.

3. The default device name is "IDU + ODU network address-IDU address". The user can rename a device. Tap the area marked "2" in Figure 36 to display the input keyboard in the lower part of the screen, as shown below. Edit the device name of the corresponding address, and tap "Confirm".



Figure 37

4.5.2 Creating/Deleting/Renaming a Group

1. Tap the "Groups" button marked "2" in Figure 35 to access the group view page in Figure 38. Figure 38 shows the interface where no groups are created.

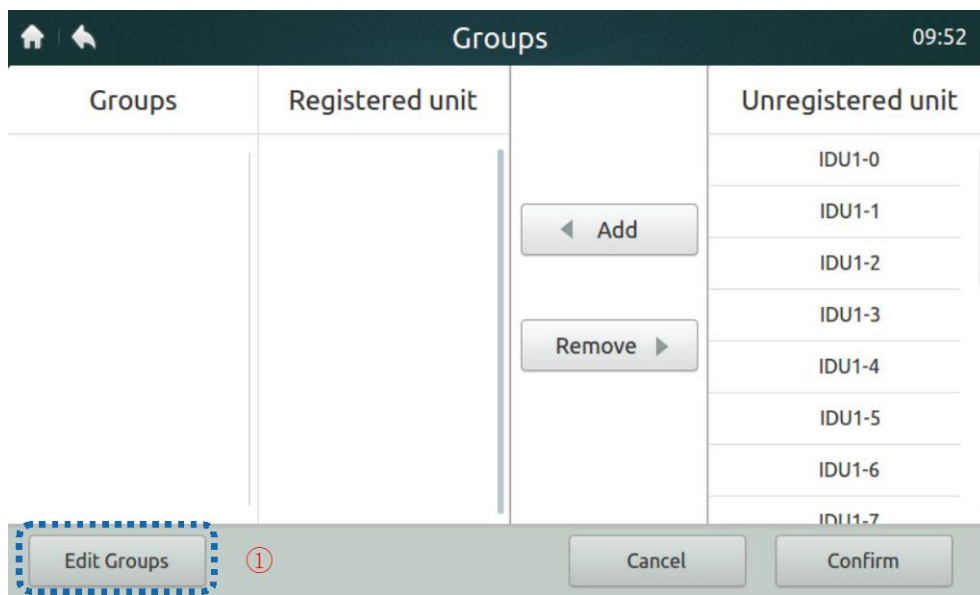

Figure 38 Homepage 1 of Group View page

2. First create a group. Tap the "Edit Groups" button marked "1" in Figure 38 to access the interface shown in Figure 39.

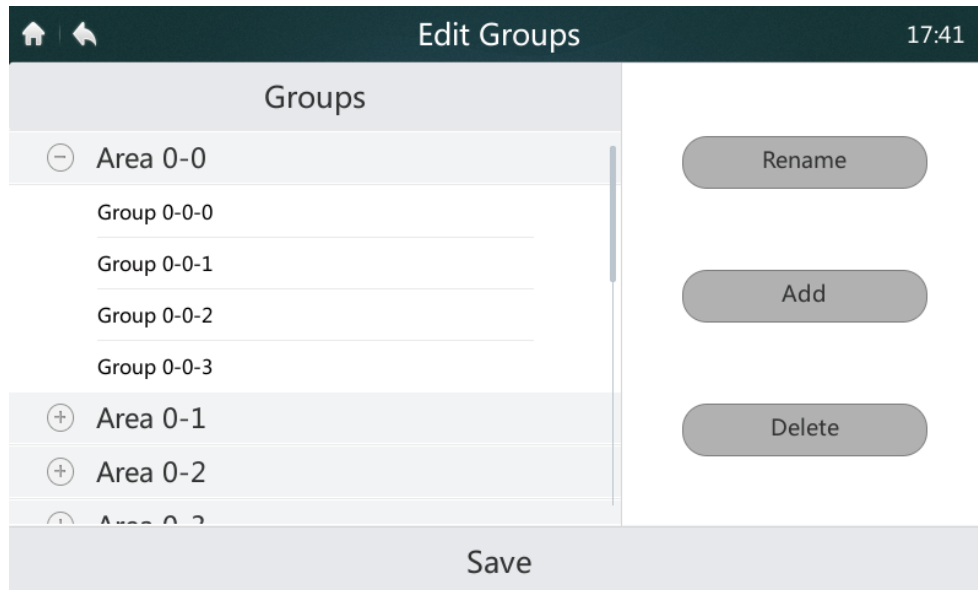

Figure 39 Editing a group

3. Groups can be classified into two levels (e.g.: level 1 - Area; level 2 - Group). Up to 10 groups can be created at level 1. Up to 5 groups can be created at level 2. Tap the "Add" button, as shown in Figure 38, to add the first level group by default. Tap to select the first level Area. Tap the "Add" button to add the second level group. To delete a group, select this group, and tap "Delete".
4. Select a group and tap "Rename", as shown in Figure 39, to edit the selected group name.
5. Tap the "Save" button, as shown in the lower part of Figure 39, to save the edited information.

4.5.3 Adding/Deleting a Device in Group

1. The user needs first to create groups. After groups are created, the group view page is displayed, as shown in Figure 40.

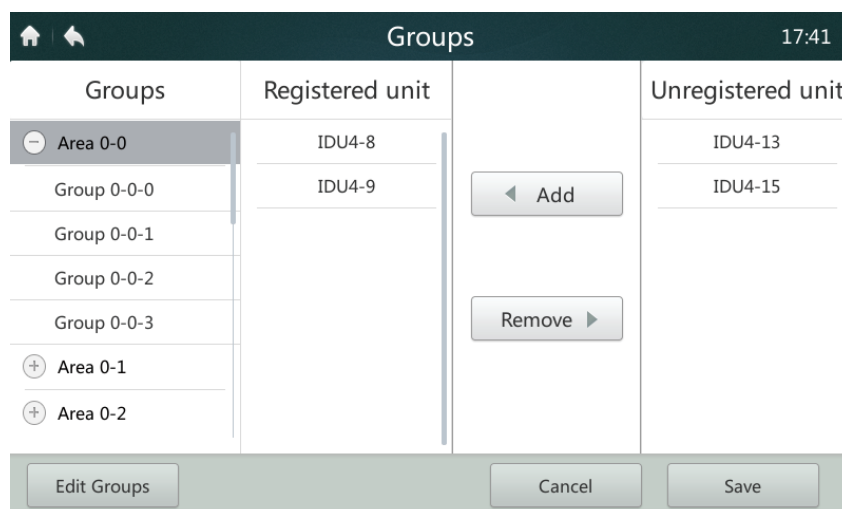

Figure 40 Homepage 2 of Group View page

2. Tap to select the group on the left for adding or deleting IDUs, as shown in Figure 40.
3. Tap to select a group on the right ungrouped device list, as shown in Figure 40. Tap the "Add" button to add it to the selected group. The device will be displayed in the grouped device list.
4. Alternatively, tap a device in the grouped device list. Tap the "Remove" button to delete the device from the group.

The device will go back to the ungrouped device list.

- After performing the above operation, tap the "Save" button in the lower right corner to save the setting, or tap "Cancel" to cancel the setting.

4.6 Settings Page

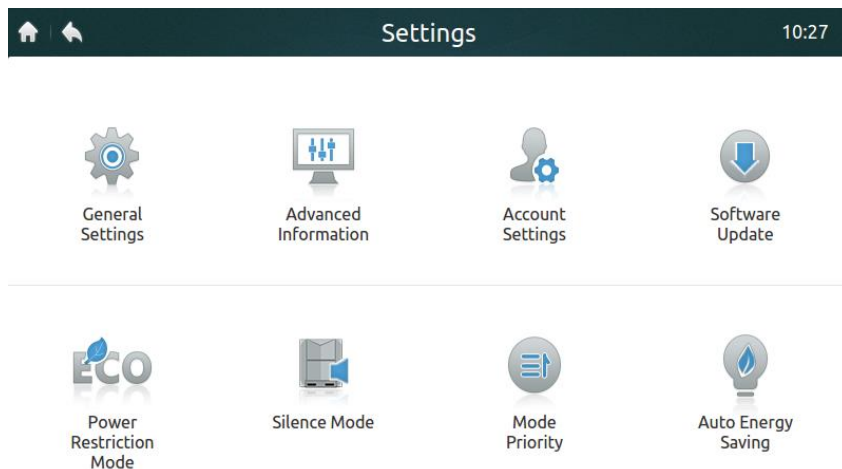

Figure 41 Homepage of Settings page

Table 10 Setting interface icons and description

Icon	Description
General Settings	Sets the date, time, locking time, backlight brightness, language and temperature unit, and provides the emergency power-off function
Advanced Information	Views the spot inspection information for the ODU and IDU
Account Settings	Edits the user account
Software Upgrade	Updates the centralized controller software version
Power Restriction Mode	ODU power restriction settings (refer to the section about energy saving DIP settings in the new generation ODU manual)
Silence Mode	ODU silence mode settings (refer to the section about silence mode settings in the new generation ODU manual)
Mode Priority	ODU mode priority settings (refer to the priority operation settings in the ODU manual)
Auto Energy Saving	ODU auto energy saving settings (refer to the energy saving operation settings in the ODU manual)

Note: Power Restriction Mode, Silence Mode, Mode Priority and Auto Energy Saving are valid for the new generation ODU only. The related operations can be performed by the installation technician and administrator only.

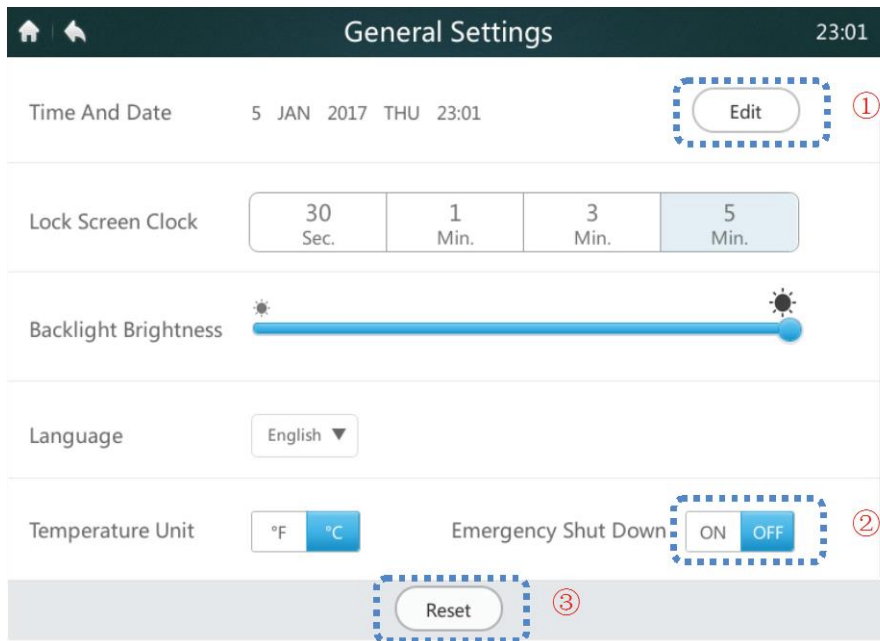

Figure 42 Homepage of General Settings

Table 11 Icons and description of General Settings

Icon	Description
Time And Date	Edits the date, time, 24-hour display and daylight saving time
Lock Screen Clock	Selects timed locking when there is no operation on the centralized controller
Backlight Brightness	Selects backlight brightness
Language	Chinese and English
Temperature Unit	Switches between °C and °F
Emergency Shut Down – ON/OFF	After the Emergency Shut Down function is enabled, all the IDUs are shut down and the remote controller is locked. The IDUs can start only after this function is disabled.
Reset	Resets the default settings and deletes user parameters

4.6.1 Setting Date and Time

1. Tap "General Settings" in Figure 41 to enter the interface, as shown in Figure 42.
2. Tap the "Edit" button marked "1" in Figure 42 to access the interface below.

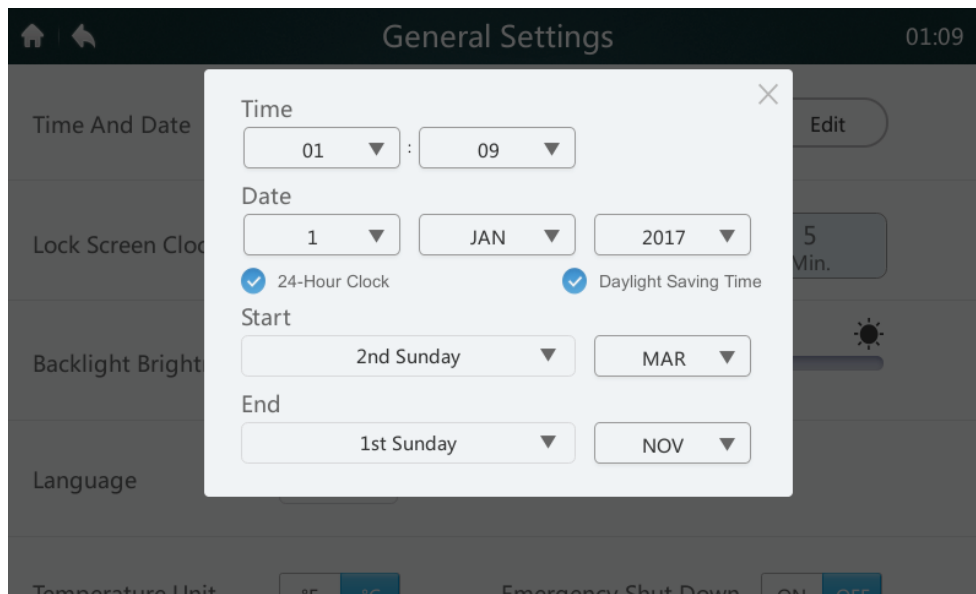

Figure 43

3. Tap the drop-down button to edit time and date. Note: The valid date range is January 1, 2000 to December 31, 2037.
4. Select "**24-Hour Clock**" to enable or disable the 24-hour clock display format.
5. Select "**Daylight Saving Time**" to enable or disable the daylight saving time setting. The default daylight saving time is the second Sunday of March to the first Sunday of November. The user can tap the drop-down menu to edit the start time and end time of daylight saving time according to actual conditions. Note: The daylight saving time is disabled by default.

4.6.2 Emergency Shut Down – ON/OFF

If an emergency occurs, tap the button marked "2" in Figure 42 to enable emergency shutdown. The centralized controller will send a shutdown command to all the IDUs and lock the remote controller. The IDUs can be restored only after the emergency switch is disabled.

4.6.3 Resetting

Only the installation technician or administrator can enable the reset function. Tap the "Reset" button marked "3" in Figure 42 to delete user information (including the schedules, groups, common user accounts and reports), and restore the default settings (including the date, screen locking time, backlight, language, temperature and daylight saving time). The prompt will be displayed by tapping the "Reset" button. To confirm the operation, tap the "Yes" button to continue and restart the centralized controller. Tap the "No" button to cancel the reset.

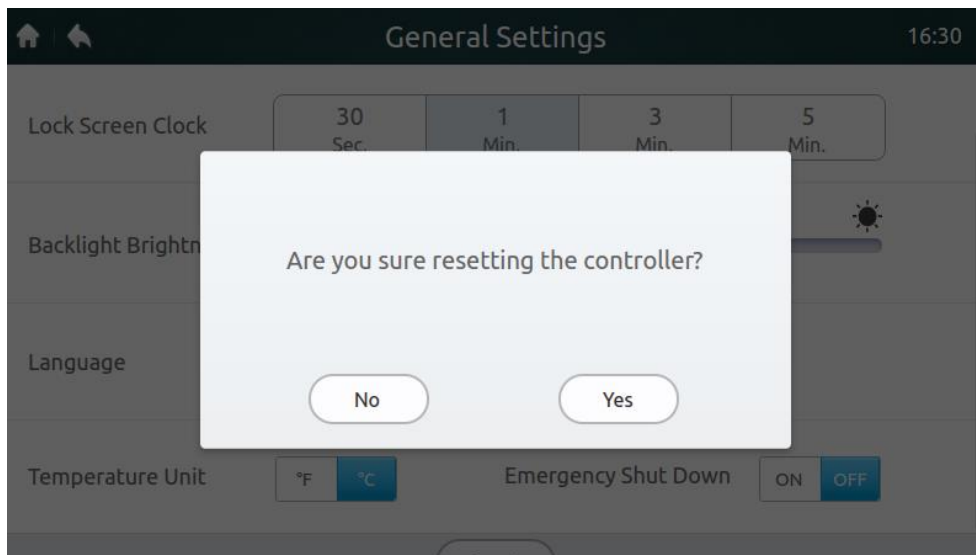

Figure 44

4.6.4 Advanced Information of IDU and ODU

1. Only the identity of the installation technician or administrator can be used to log in to the centralized controller and view parameter information. The system will prompt a common user that viewing permission is not available, as shown below:

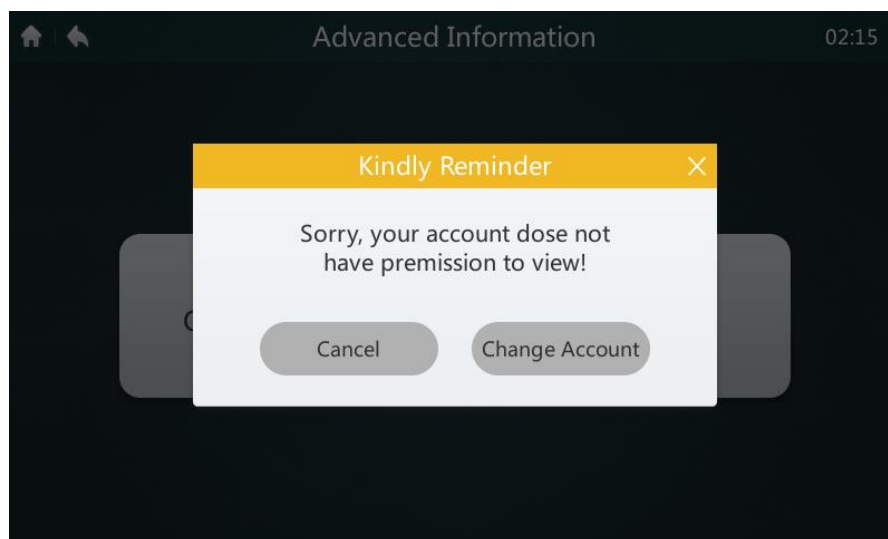

Figure 45

2. Tap "Advanced Information", as shown in Figure 41, to enter the interface below. You can select to view the ODU or IDU parameters. For details, see Tables 12 and 13.

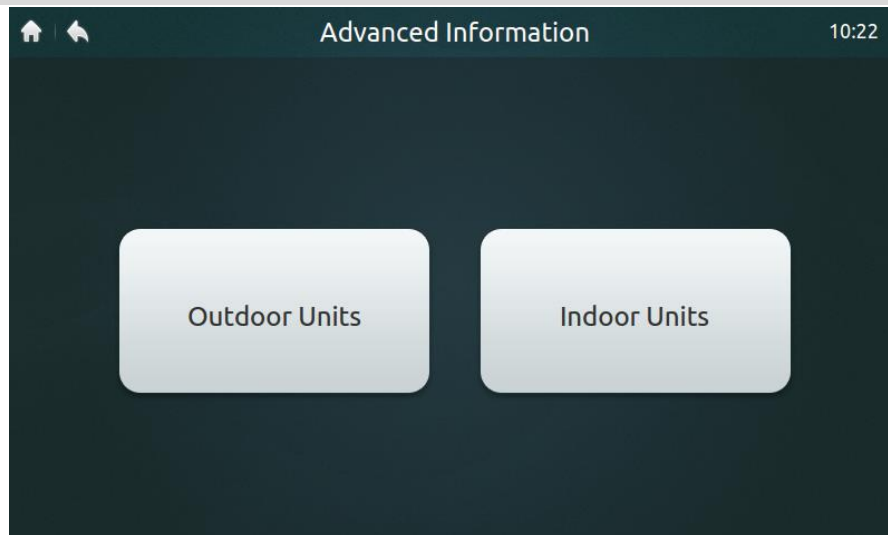

Figure 46

Table 12 Advanced information parameters of new generation ODU

No.	Parameter	Description
1	Address	ODU address
2	T4	T4 ambient temperature
3	T2/T2B	T2/T2B average temperature (corrected)
4	T3	T3 condenser tube temperature
5	TpA	Inverter compressor A discharge temperature
6	TpB	Inverter compressor B discharge temperature
7	IA	Inverter compressor A current
8	IB	Inverter compressor B current
9	Fan A	DC fan A/A1 speed
10	Fan B	DC fan B/B1 speed
11	EXV A	Electronic expansion valve A opening
12	EXV B	Electronic expansion valve B opening
13	EXV C	Electronic expansion valve C opening
14	OP Mode	Operating mode
15	Pri Mode	Mode priority
16	Running Cap.	ODU running capability (reserved)
17	ODU Qty	Number of modular ODUs (reserved)
18	ODU Cap.	ODU capacity
19	Tf1	Tf1 inverter module A temperature
20	Tf2	Tf2 inverter module B temperature (reserved)
21	T6B	T6B plate heat exchanger outlet temperature

22	T6A	T6A plate heat exchanger inlet temperature
23	Superheat	System discharge superheat degree
24	IDU No.	Number of IDUs (reserved)
25	IDU Run No.	Number of operating IDUs
26	ODU demand	Actual energy demand of the ODU
27	H pressure	High pressure of the system
28	L pressure	Low pressure of the system (reserved)
29	Last error	Last error (current)
30	Freq. A	Compressor 1 frequency
31	Freq. B	Compressor 2 frequency
32	Version	Program version No.

Table 13 Advanced Information Parameters of 2nd generation IDU

No.	Parameter	Description
1	Address	IDU and ODU communication address
2	Group	Wired controller group No.
3	HP	Capacity HP of IDU
4	Net. Addr	IDU address
5	Ts	Actual set temperature Ts
6	T1	Actual T1 indoor temperature
7	T2	Actual T2 indoor temperature
8	T2A	Actual T2A indoor temperature
9	T2B	Actual T2B indoor temperature
10	Comp. temp	Compressor discharge temperature (reserved)
11	Superheat	Target superheat degree (reserved)
12	EXV degree	EXV opening (actual opening/8)
13	Version	Software version No.
14	Error code	Error code

4.6.5 Adding/Deleting Common User Accounts (up to 15)

1. The identity of the installation technician or administrator must be used to log in to the centralized controller.
2. Tap "Account Settings", as shown in Figure 41, to enter the interface, as shown in Figure 47.

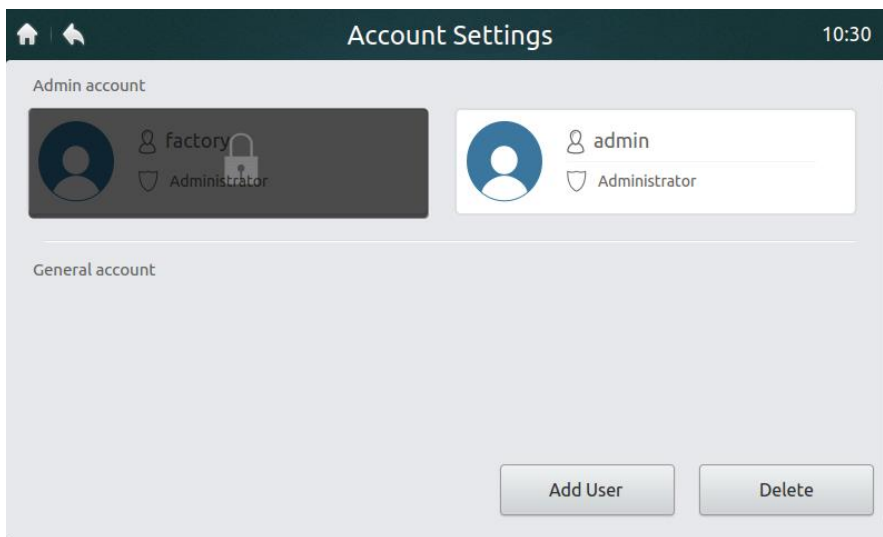

Figure 47 Homepage of Account Settings page

3. Tap the "Add User" button in the lower right corner of Figure 47 to display the interface below. Enter the user name and password (enter the password twice), and then tap the "Add" button to save the setting. Tap the "Cancel" button to cancel the setting.

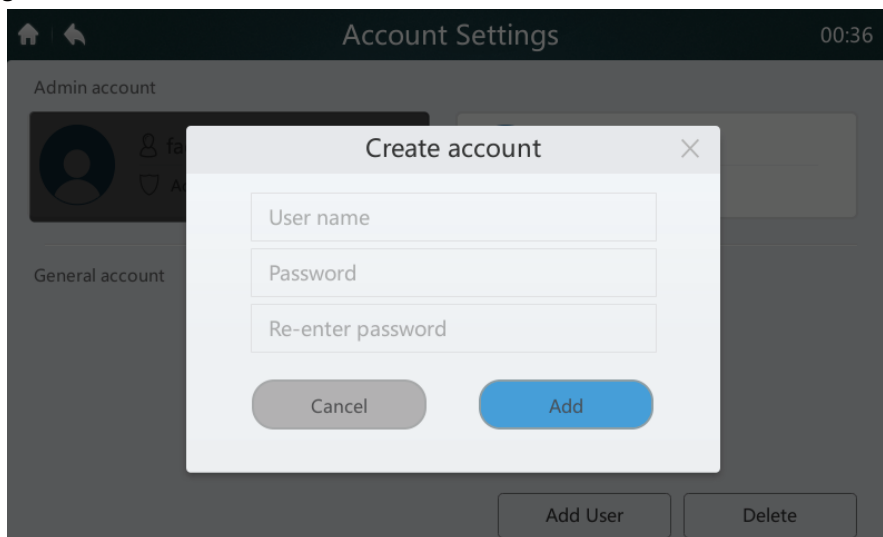

Figure 48

- Tap the "Delete" button in the lower right corner, as shown in Figure 47, to display the icon in the top right corner of common user account, as shown below. Tap the icon in the top right corner of the user to be deleted.

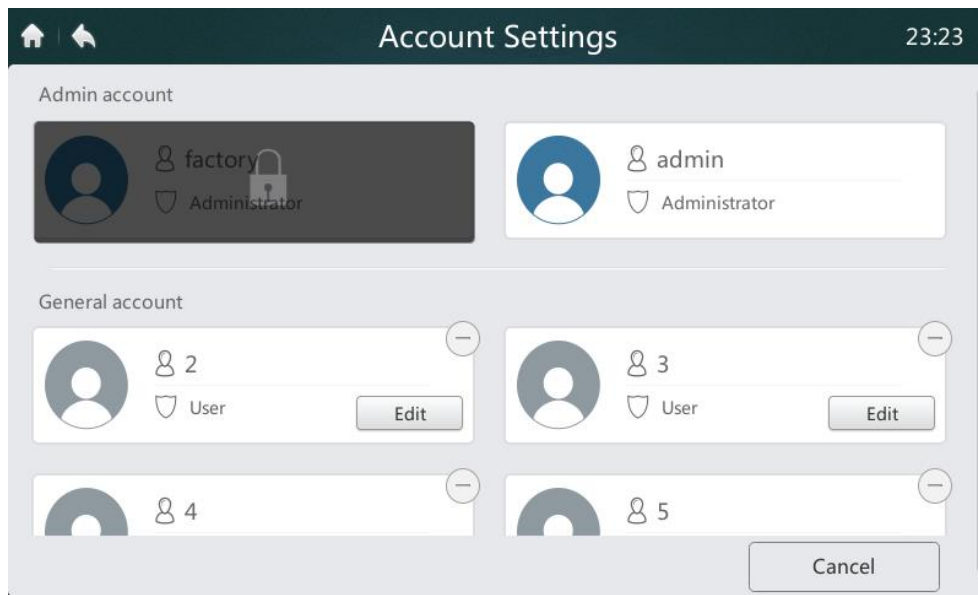

Figure 49

- Enter the administrator name in the prompt box below. Tap the "Delete" button to delete the user. Tap the "Cancel" button to cancel the deletion.

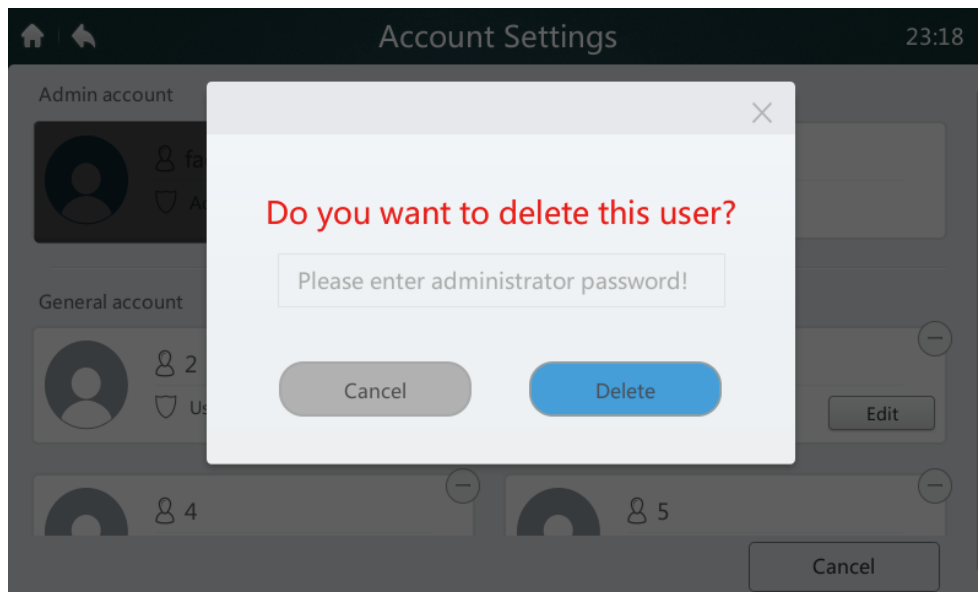

Figure 50

4.6.6 Upgrading Software Version

- Download the upgrade software and the corresponding check code to the root directory of the USB storage device. Then, insert it into the USB interface at the bottom of the centralized controller. Update cannot be executed if the check code is not downloaded.
- Tap "Software Update" in Figure 41 to enter the interface below. If the centralized controller finds valid upgrade packages, the number of valid upgrade packages will be displayed at the position marked with 1.



Figure 51

3. Tap the position marked "1" in the above figure to enter the interface below, which displays the upgrade packages (e.g., MD.00.XX).

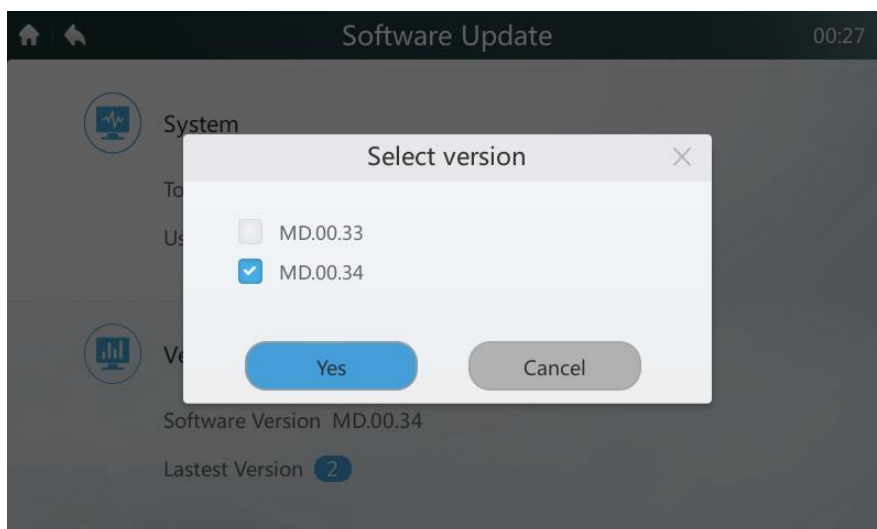

Figure 52

4. Select the version to be upgraded in the upgrade list. A small blue tick is displayed when the version is selected. After you tap "Yes", the system will ask you again whether to start the installation, as shown below. Tap the "Yes" button to start the upgrade.

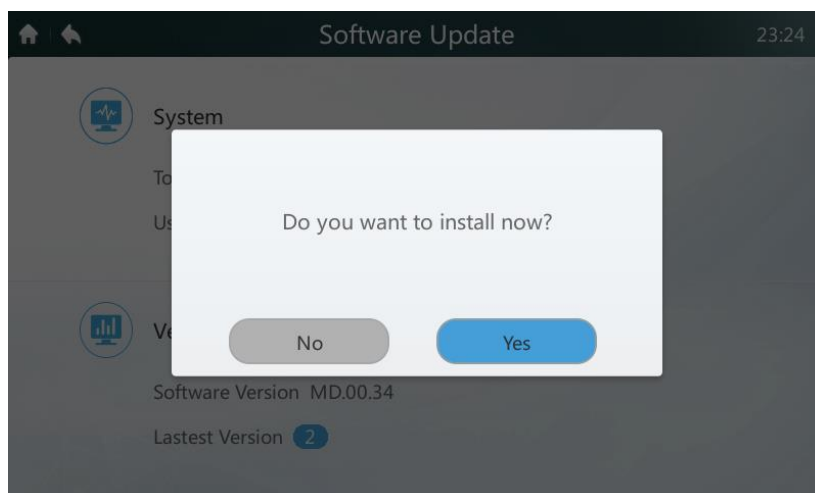

Figure 53

4.6.7 Setting Power Restriction Mode

The setting is valid for new generation ODU. Only the installation technician and administrator can perform the operation. For the options description, see Table 14.

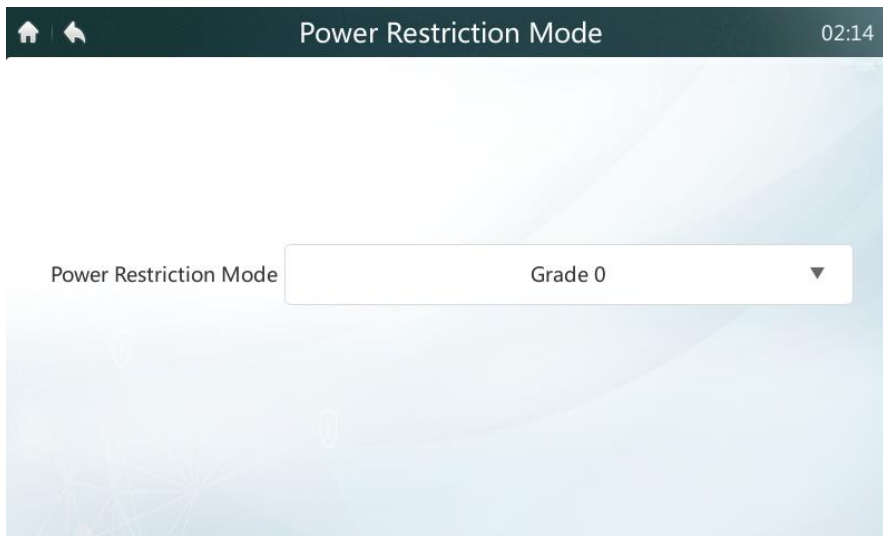

Figure 54

4.6.8 Setting Silent Mode

The setting is valid for new generation ODU. Only the installation technician and administrator can perform the operation. For the options description, see Table 14.

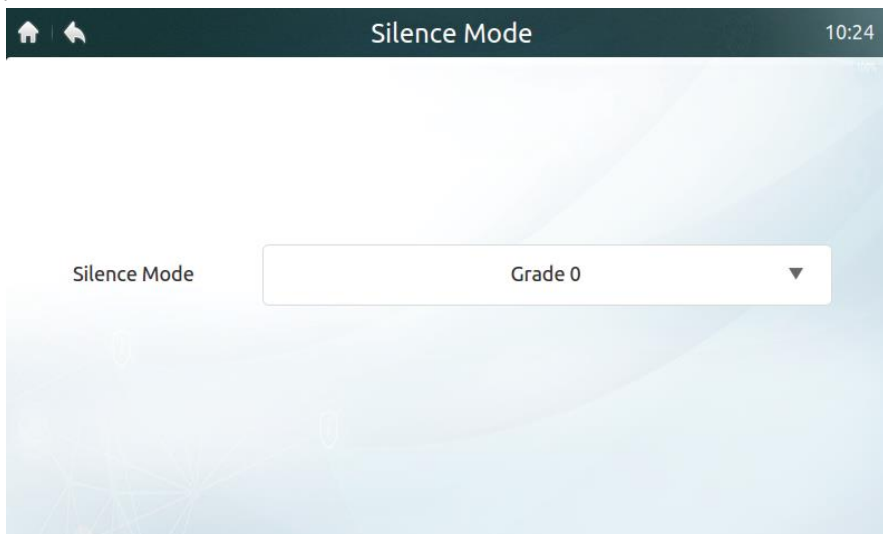

Figure 55

4.6.9 Setting Mode Priority

The setting is valid for new generation ODU. Only the installation technician and administrator can perform the operation. For the options description, see Table 14.

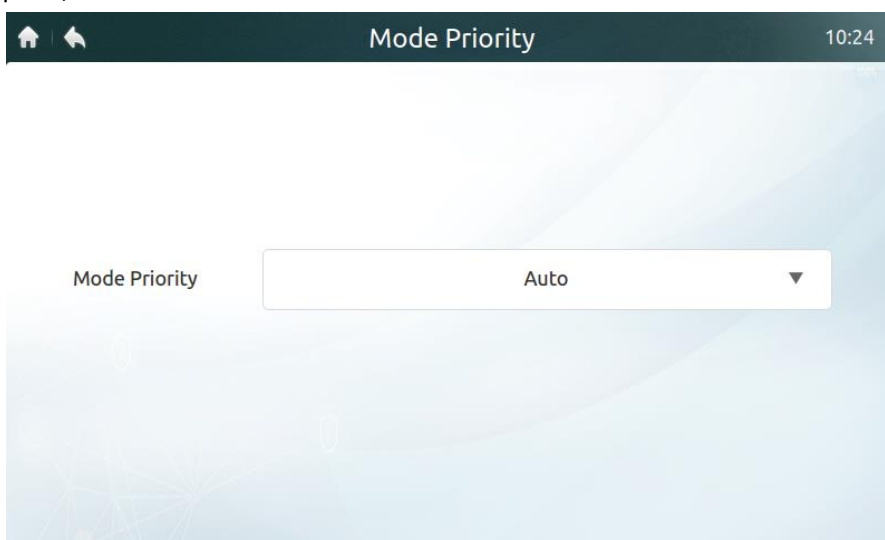

Figure 56

4.6.10 Setting Auto Energy Saving

The setting is valid for new generation ODU. Only the installation technician and administrator can perform the operation. For the options description, see Table 14.

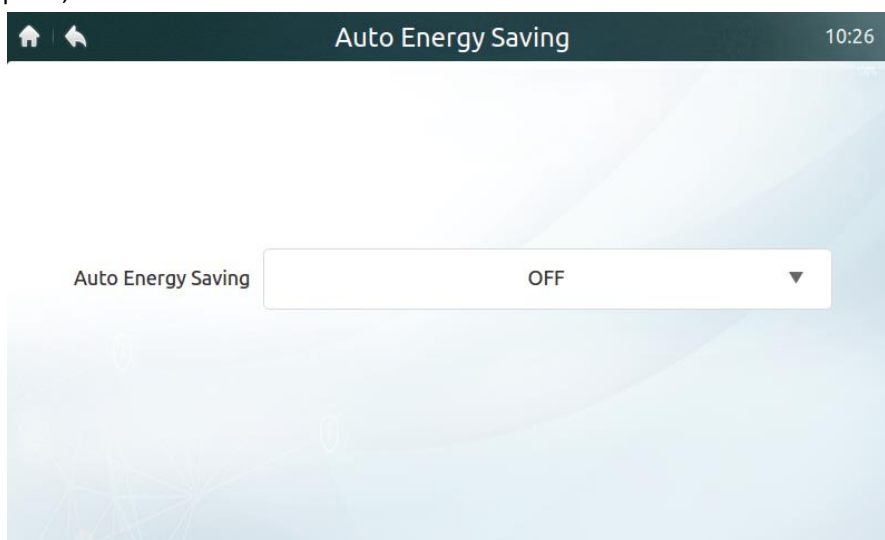

Figure 57

Table 14 Set DIP table and centralized controller options of new generation ODU

Definition	ODU parameter	Centralized Controller Options
Power Restriction Mode	n41: Power limitation mode 1 (Only available for the master unit, 100% capacity output)	Grade 0
	n42: Power limitation mode 2 (Only available for the master unit, 90% capacity output)	Grade 1
	n43: Power limitation mode 3 (Only available for the master unit, 80% capacity output)	Grade 2
	n44: Power limitation mode 4 (Only available for the master unit, 70% capacity output)	Grade 3
	n45: Power limitation mode 5 (Only available for	Grade 4

	the master unit, 60% capacity output)	
	n46: Power limitation mode 6 (Only available for the master unit, 50% capacity output)	Grade 5
	n47: Power limitation mode 7 (Only available for the master unit, 40% capacity output)	Grade 6
Silent Mode	0: Night silent time is 6h/10h (default)	8
	1: Night silent time is 6h/12h	9
	2: Night silent time is 8h/10h	10
	3: Night silent time is 8h/12h	11
	4: No silent mode	0
	5: Silent mode 1 (only limit max fan speed)	1
	6: Silent mode 2 (only limit max fan speed)	2
	7: Silent mode 3 (only limit max fan speed)	3
	8: Super silent mode 1 (limit max. fan speed and compressor frequency)	4
	9: Super silent mode 2 (limit max. fan speed and compressor frequency)	5
	A: Super silent mode 3 (limit max. fan speed and compressor frequency)	6
	B: Super silent mode 4 (limit max. fan speed and compressor frequency)	7
	F: Set silent mode via the centralized controller (To use the software settings, the corresponding function's DIP switch code must be configured in the outdoor units)	
Mode Priority	000: Auto Priority	Auto Priority
	001: Cool Priority	Cool Priority
	010: VIP	VIP
	011: Heat Only	Heat Only
	100: Cool Only	Cool Only
	111: Set silent mode via the centralized controller (To use the software settings, the corresponding function's Dip switch code must be configured in the outdoor units)	
Auto Energy Saving	nb3: Exit auto power saving mode	OFF
	nb4: Enter auto power saving mode	ON

4.7 Help Interface

This manual is intended for reference only. Refer to the error shown on the actual device for troubleshooting.

Please consult a Midea engineer to check if the error code of the specific model belongs to a "new-generation refrigerant system".

Table 15 Error codes for new generation ODU

Code	ODU Error Description
E0	Communication error between outdoor units
E1	Phase sequence error
E2	Communication error between an indoor unit and the master unit
E4	Outdoor heat exchanger temperature sensor (T3) error or outdoor ambient temperature sensor (T4) error
E5	Abnormal power supply voltage
E6	Abnormal module temperature or Tf temperature sensor
E7	Compressor top or discharge pipe temperature sensor (T7C1/2) error
E8	Outdoor unit address error
xE9	EEPROM mismatch
xF1	PTC error
F3	Plate heat exchanger cooling refrigerant outlet temperature sensor (T6B) error
F5	Plate heat exchanger cooling refrigerant inlet temperature sensor (T6A) error
F6	Electronic expansion valve (EEV) connection error
xH0	Communication error between the main control chip and inverter driver chip
H2	Number of slave units detected by the master unit has decreased
H3	Number of slave units detected by the master unit has increased
xH4	Inverter module protection
H5	P2 protection appears three times in 60 minutes
H6	P4 protection appears three times in 100 minutes
H7	The number of indoor units detected by the master unit is different to the number set on main PCB
H8	High pressure sensor error
H9	P9 protection appears ten times in 120 minutes
C7	PL protection appears three times in 100 minutes
P1	Discharge pipe high-pressure protection
P2	Suction pipe low-pressure protection
xP3	Compressor current protection
P4	Discharge temperature protection
P5	Outdoor heat exchanger temperature protection
P9	Fan module protection
PL	Inverter module temperature protection
PP	Compressor discharge insufficient superheat protection
xL0	Inverter module protection
xL1	DC bus low voltage protection
xL2	DC bus high voltage protection
xL4	MCE error

xL5	Zero speed protection
xL7	Phase sequence error
xL8	The compressor frequency variation is greater than 15 Hz within one second of protection
xL9	The actual compressor frequency differs from the target frequency by more than 15 Hz protection
yHD	Slave unit malfunction

Note:

1. 'x' is a placeholder for the compressor system (compressor and related electrical components), with 1 representing compressor system A and 2 representing compressor system B.
2. For some error codes, a manual restart is required before the system can resume normal operations.
3. Once the EEV is connected properly, a manual restart is required before the system can resume normal operations.

Table 16 Error codes for IDUs

Error code	Content
FE	Indoor unit has not been assigned an address
Ed	Outdoor unit error
EE	Water level error
E0	Mode conflict
Eb	EEV error
E1	Communication error between indoor and outdoor units
E2	Indoor ambient temperature sensor error
E3	Indoor heat exchanger mid-point temperature sensor error
E4	Indoor heat exchanger outlet temperature sensor error
E6	Fan error
E7	EEPROM mismatch



Midea CAC After-service Application



iOS Version



Android Version

Commercial Air Conditioner Division Midea Group

Add.: Midea Headquarters Building, 6 Midea Avenue, Shunde, Foshan, Guangdong, China

Postal code: 528311

Tel: +86-757-26338346 Fax: +86-757-22390205

cac.midea.com global.midea.com

Note: Product specifications change from time to time as product improvements and developments are released and may vary from those in this document.