



improve your life

# GREENSTYLE PLUS SINGLE SPLIT AIR CONDITIONERS – R32

## USER MANUAL and INSTALLATION GUIDE

---



### INDOOR UNIT

GREENSTYLE PLUS 9000 UI  
GREENSTYLE PLUS 12000 UI  
GREENSTYLE PLUS 18000 UI  
GREENSTYLE PLUS 24000 UI

### OUTDOOR UNIT

GREENSTYLE PLUS 9000 UE  
GREENSTYLE PLUS 12000 UE  
GREENSTYLE PLUS 18000 UE  
GREENSTYLE PLUS 24000 UE

**Please read this manual carefully before installing and using the air conditioner, and retain for future reference.**

V 11/21

# INDEX

---

General warnings.....	44
Safety precautions.....	45
Notices for usage.....	47
Description of parts.....	49
Remote controller Guide.....	50
Wifi Guide.....	55
Clean and care.....	59
Troubleshooting.....	61
Notices for installation.....	63
Indoor unit installation.....	68
Outdoor unit installation.....	71
Maintenance notes.....	74
Warnings for the refrigeration system specialist.....	77

## REQUIREMENTS FOR INSTALLATION AND MAINTENANCE PERSONNEL

All personnel who carry out installation and / or maintenance operations on the units must be equipped with PEF (European Refrigerators License) as required by the D.P.R. n. 146/2018 implementing Regulation (EU) no. 517/2014. If another technician is required to maintain and repair the equipment, this will need to be supervised by the person who is qualified to use flammable refrigerants.

The repair must be performed according to the methodology indicated by the manufacturer of the equipment.

If you need to install, move or service the air conditioner, please contact your dealer or local service center for the procedure first. The air conditioner must be installed, moved or maintained by authorized personnel. Failure to do so could result in serious damage, personal injury or death.

## General warnings



Appliance filled with flammable gas R32.



Before using the appliance, read the owner's manual.



Before installing the appliance, read the installation manual.



Before repairing the appliance, read the service manual.

## The Refrigerant

- To realize the function of the air conditioner unit, a special refrigerant circulates in the system. The refrigerant is the fluoride R32 = GWP (Global warming potential). This refrigerant is flammable and inodorous. It can lead to explosions under certain conditions, however the flammability of this refrigerant is very low and it can be ignited only by fire.
- Compared to other common refrigerants, R32 is a non-polluting refrigerant with no harm to the ozonosphere and a lower effect upon the greenhouse effect. R32 has very good thermodynamic features which lead to a really high energy efficiency. The units therefore need less filling.

### Warning:

Do not try to accelerate the defrosting process or to clean the appliance in different ways other than those recommended by the manufacturer. Should repair be necessary, contact your nearest authorized Argoclima Service Centre. Any repairs carried out by unqualified personnel may be dangerous. The appliance has to be stored in a room that doesn't have any continuously operating ignition sources. (for example: open flames, an operating gas appliance or an operating electric heater.) Do not pierce or burn.

Appliance has to be installed, operated and stored in a room with a floor area larger than X m<sup>2</sup>. (Please refer to table "a" in section of " Safety Operation of Inflammable Refrigerant" for Space X.)



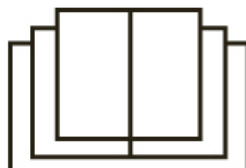



For repairs, strictly follow manufacturer's instructions only for appliances filled with R32 flammable gas. Be aware that refrigerants do not have any odour.

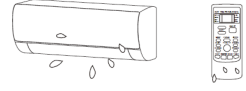

## SAFETY PRECAUTIONS

### WARNING

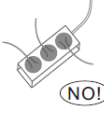
This appliance can be used by children aged from 8 years and above and persons with reduced physical, sensory or mental capabilities or lack of experience and knowledge if they have been given supervision or instruction concerning use of the appliance in a safe way and understand the hazards involved. Children shall not play with the appliance. Cleaning and user maintenance shall not be made by children without supervision.

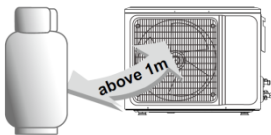
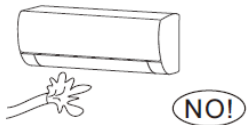
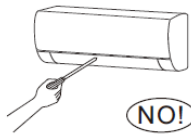
 <p><b>The air conditioner must be grounded. Incomplete grounding may result in electric shocks.</b></p> <p>Do not connect the earth wire to the gas pipeline, water pipeline, lightning rod, or telephone earth wire.</p>	 <p><b>Always switch off the device and cut the power supply when the unit is not in use for long time so as to ensure safety.</b></p>	<p><b>Take care not let the remote control and the indoor unit watered or being too wet.</b></p>  <p><b>NO!</b></p> <p>Otherwise, it may cause short circuit.</p>
 <p><b>If the supply cord is damaged, it must be replaced by the manufacturer, its service agent or similarly qualified persons in order to avoid a hazard.</b></p>	<p><b>Don't cut off main power switch during operating or with wet hands.</b></p>  <p><b>NO!</b></p> <p>It may cause electric shock.</p>	<p><b>Don't share the socket with other electric appliance.</b></p>  <p><b>NO!</b></p> <p>Otherwise, it may cause electric shock even fire and explosion.</p>
<p><b>Always switch off the device and cut the power supply before performing any maintenance or cleaning.</b></p>  <p>Otherwise, it may cause electric shock or damage</p>	<p><b>Don't pull the power cable.</b></p>  <p><b>NO!</b></p> <p>The damage of pulling power cord will cause serious electric shock.</p>	<p><b>A warning that ducts connected to an appliance shall not contain an ignition source.</b></p>
 <p><b>Don't install air conditioner in a place where there is flammable gas or liquid. The distance between them should above 1m.</b></p> <p>It may cause fire even explosion.</p>	 <p><b>NO!</b></p> <p><b>Don't use liquid or corrosive cleaning agent wipe the air conditioner and sprinkle water or other liquid either.</b></p>	 <p><b>NO!</b></p> <p><b>Don't attempt to repair the air conditioner by yourself.</b></p> <p>Incorrect repairs may cause fire or explosion. Contact a qualified service technician for all service requirement.</p>

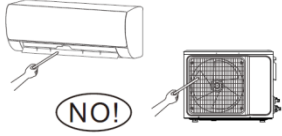
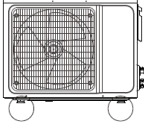
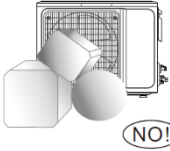
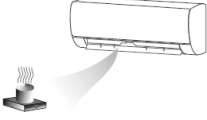
 <p><b>Don't use air conditioner in lightning storm weather.</b></p> <p>Power supply should be cut in time to prevent the occurrence of danger.</p>	 <p><b>Don't put hands or any objects into the air inlets or outlets.</b></p> <p>This may cause personal injury or damage to the unit.</p>	 <p><b>Please note whether the installed stand is firm enough or not.</b></p> <p>If it is damaged, it may lead to the fall of the unit and cause the injury.</p>
 <p><b>Don't block air inlet or air outlet.</b></p> <p>Otherwise, the cooling or heating capacity will be weakened, even cause system stop operating.</p>	 <p><b>Don't let the air conditioner blow against the heater appliance.</b></p> <p>Otherwise it will lead to incomplete combustion, thus causing poisoning.</p>	<p><b>The appliance shall be installed in accordance with national wiring regulations.</b></p> <p><b>An earth leakage breaker with rated capacity must be installed to avoid possible electric shocks.</b></p>



**INFORMATION FOR CORRECT DISPOSAL OF THE PRODUCT IN ACCORDANCE WITH THE EUROPEAN DIRECTIVE 2012/19/EU**

At the end of its working life this equipment must not be disposed of as an household waste. It must be taken to special local community waste collection centres or to a dealer providing this service. Disposing of electrical and electronic equipment separately avoids possible negative effects on the environment and human health deriving from an inappropriate disposal and enables its components to be recovered and recycled to obtain significant savings in energy and resources. In order to underline the duty to dispose of this equipment separately, the product is marked with a crossed-out dustbin.

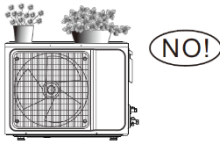
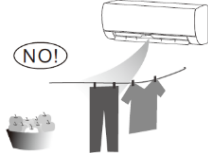
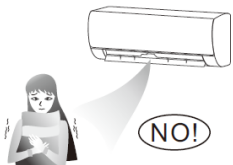
<p><b>Don't open the windows and doors for long time when the air conditioner is running.</b></p>  <p>Otherwise, the cooling or heating capacity will be weakened.</p>	 <p><b>Don't stand on the top of the outdoor unit or place heavy things on it.</b> This could cause personal injuries or damage the unit.</p>	 <p><b>Don't use the air conditioner for other purposes, such as drying clothes, preserving foods, etc.</b></p>
 <p><b>Don't apply the cold air to the body for a long time.</b> It will deteriorate your physical conditions and cause health problems.</p>	<p><b>Set the suitable temperature.</b></p> <p>It is recommended that the temperature difference between indoor and outdoor temperature should not be too large.</p> <p>Appropriate adjustments of the setting temperature can prevent the waste of electricity.</p>	<p><b>If your air conditioner is not fitted with a supply cord and a plug, an anti-explosion all-pole switch must be installed in the fixed wiring and the distance between contacts should be no less than 3.0 mm.</b></p>

Fuse Type: T3.15AH250V, the electricity passing through the fuse cannot be higher than 3.15A.

For the air conditioner permanently connected to an outlet, equip the line with a power switch. The current switch must be single-pole, with a distance between the contacts greater than 3 mm and a residual nominal value not greater than 30mA.

The power supply circuit must have a leakage protection device and an air switch whose rated capacity should be greater than 1.5 times the maximum current.

**NOTICES FOR USAGE**

**OPERATING RANGE**

Cooling mode: from +16°C to +49°C (outdoor temperature)  
 Heating mode: from -15°C to +30°C (outdoor temperature)

- When the temperature is too high, the air conditioner may activate the automatic protection device, so that the air conditioner could be shut down.
- When the temperature is too low, the heat exchanger of the air conditioner may freeze, leading to water dripping or other malfunction.
- In long-term cooling or dehumidification with a relative humidity of above 80% (doors and windows are open), there may be water condenses or dripping near the air outlet.

## NOTES FOR HEATING FUNCTION

---

- When the heating function is started, the indoor unit fan will not work immediately to avoid the introduction of insufficiently hot air into the environment.
- When the outdoor temperature is very low and the humidity is high, ice may form on the heat exchanger of the outdoor unit. Then the air conditioner will start defrost function.
- During defrost, the air conditioner will stop heating for about 5-12 minutes.
- Vapor may come out from the outdoor unit during defrost. This is not a malfunction, but a result of fast defrost.
- Heating will resume after defrost is complete.

## NOTES FOR TURNING OFF

---

- When the air conditioner is turned off, the unit may continue to ventilate for a few minutes to help dry the battery of the indoor unit.

## EMERGENCY OPERATION

---

- If the remote control is faulty, use the emergency button located under the front panel of the indoor unit (see image).
- If this button is pushed with the unit OFF, the air conditioner will operate in Auto mode.
- If this button is pushed with the unit ON, the air conditioner will stop running.

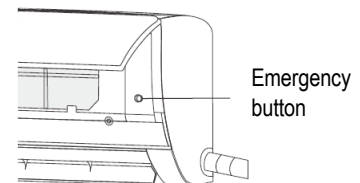

## AIRFLOW DIRECTION ADJUSTMENT

---

1. Use the vertical oscillation button on the remote control to set the direction of the air flow.
2. It is possible to direct the air flow also horizontally; this operation is only possible manually, by moving the air delivery flaps as desired (see image).

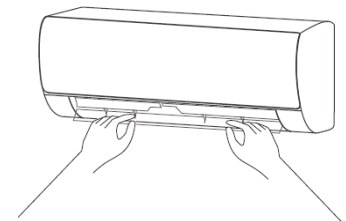

**Note:** Move the air vents before the unit is in operation, or your finger might be injured.

**Never place your hand into the air inlet or outlet when the air conditioner is in operation.**

## DESCRIPTION OF PARTS

### INDOOR UNIT

---

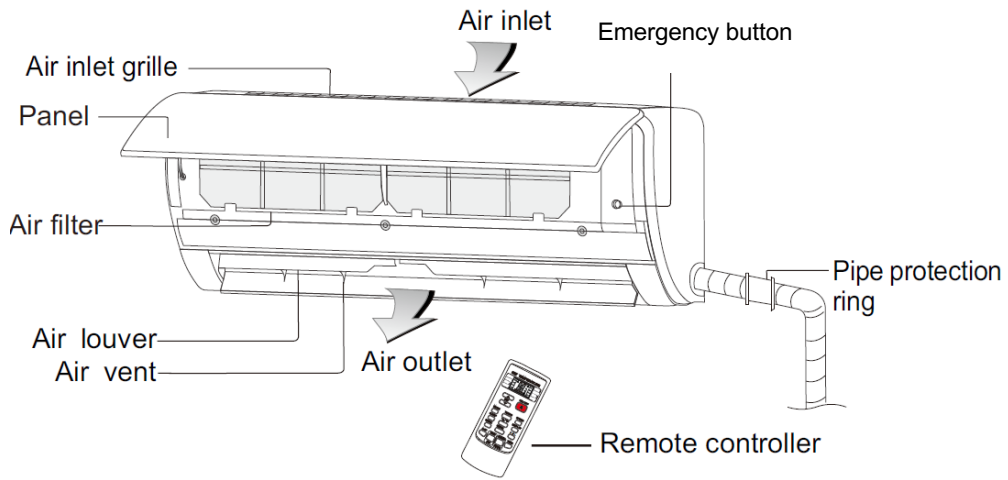

### OUTDOOR UNIT

---

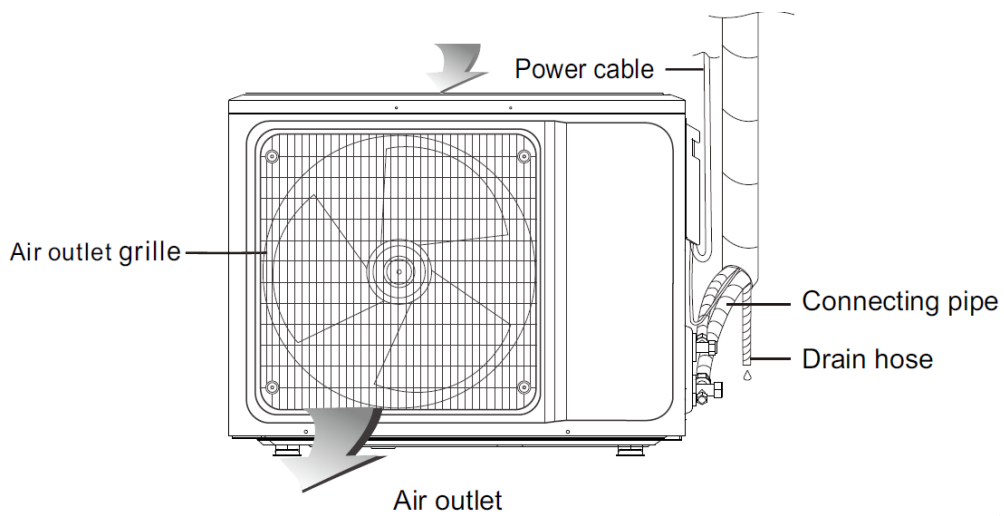

**Note:** All the illustrations in this manual are for explanation purpose only. Your air conditioner may be slightly different. The actual shape shall prevail.



## REMOTE CONTROL USER GUIDE

1. At first time use of the remote controller, install the batteries and ensure that the "+" and "-" poles are correctly positioned. To insert the batteries, follow the instructions below:

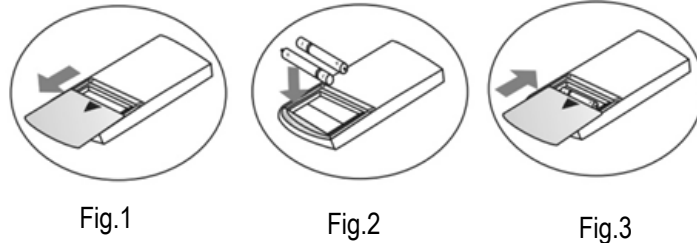

- Slide to open the cover according to the direction indicated by the arrowhead (Fig.1)
- Insert two brand new batteries, and position the batteries to the right electric poles (Fig.2).
- Put back the cover according to the direction indicated by the arrowhead (Fig.3)

2. Ensure the remote controller is pointed to the signal receiving window, and that there is no obstruction in between and the distance is 8m at the maximum.

3. Do not let the remote controller drop or fling it at will. Do not let any liquid in the remote controller.

4. Do not expose the remote controller directly to the sunlight or excessive heat.

5. If the remote controller does not work normally, remove the batteries for 30 seconds before reinstall them. If that doesn't work, replace the batteries.

6. When replacing the batteries, do not mix the new batteries with old ones or mix batteries of different types, which could cause failure of the remote controller.

7. If the remote controller is not to be used for a long period of time, remove the batteries first, lest the leakage from them may damage the remote controller.

8. Properly dispose the discarded batteries.



### **INFORMATION FOR THE CORRECT DISPOSAL OF BATTERIES IN ACCORDANCE WITH EUROPEAN DIRECTIVE 2006/66/EC and MODIFICATIONS INTRODUCED BY DIRECTIVE 2013/56/EU**

Replace batteries when they are depleted. At the end of their life, batteries must be disposed of separately from unsorted waste. They must be taken to designated recycling centres or returned to a retailer providing this service. Separate disposal of batteries helps to reduce the potential harmful effects on the environment and human health caused by their improper disposal and also enables the recovery and recycling of component materials, saving significant energy and resources. The requirement for separate disposal is indicated by the crossed-out wheeled bin label affixed to the appliance. Illegal disposal of the product by the user is subject to administrative penalties as per current regulations.

## BUTTONS DESCRIPTION

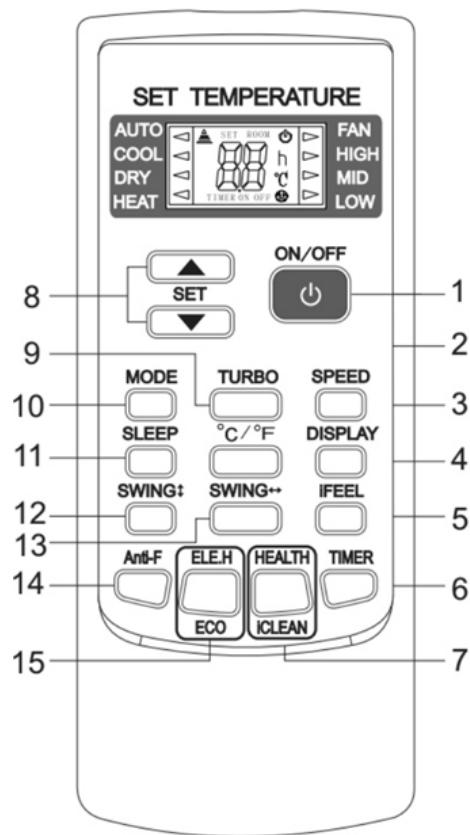

### 1. ON/OFF button

With this button you can turn the unit on or off. This button can also be used to reset the timer and the SLEEP function.

### 2. °C/ °F button

Press this button to select the temperature unit of measurement, the selectable units are Fahrenheit (° F) or Celsius (° C) which is the default unit. When pressed for the first time, ° F will be selected, and the ° C symbol will no longer appear on the display. Press again to select ° C.

**NOTE: Some models do not have the possibility to select the temperature in ° F; this means that when the ° C / ° F" button is pressed, the °F symbol may appear on the remote control display, but the temperature will continue to be displayed in ° C on that of the air conditioner.**

### 3. SPEED button

- Press this button, you can select the fan speed as follows:



**Note: AUTO air speed is not available in FAN mode.**

### 4. DISPLAY button

It is possible to turn the remote control display on or off, while the unit is running, to extend the life of the batteries.

## 5. iFEEL button

Pressing this button activates the IFeel function. The LCD screen shows the room temperature and when the function is canceled it shows the set temperature. This function is not active in AUTO and FAN mode.

## 6. TIMER button

When the air conditioner is on, press this button to deactivate the TIMER function, or when it is off to activate it. When the button is pressed, the display will show "ON (OFF)" flashing. It is possible to press the "▲" and "▼" buttons to set the timer, each press will increase or decrease the timer by 0.5h up to 10h, then the time interval will be 1h. The settable range is 0.5-24h. Press the "TIMER" button again to activate the function, the "ON (OFF)" symbol will stop flashing. If the "TIMER" button is not pressed for 10 seconds while the "ON (OFF)" symbol flashes on the display, the TIMER function will be canceled. If the TIMER function is active, pressing this button will deactivate it.

**NOTE: When the TIMER function is active, all function buttons (except SLEEP, DISPLAY and iFEEL) are usable.**

## 7. HEALTH/iCLEAN button

This button has two functions.

- a. HEALTH (FUNCTION NOT AVAILABLE)
- b. iCLEAN

When the remote control is off, press the "iClean" button to activate the "iClean" function with a maximum duration of 30 minutes. The purpose of this function is to clean the evaporator from dust, dry the water inside the evaporator and prevent the formation of mold which can cause the spread of bad odors.

After setting the "iClean" function, press the "iClean" button again to cancel the function or press the ON / OFF button to cancel the "iClean" function and turn on the appliance.

The "iClean" function is deactivated after 30 minutes of operation if no operation takes place.

Note: the iClean function can be set in parallel with the "Timer on" function; in this case, the "Timer on" function will be executed after the "iClean" function.

## 8. ▲ or ▼ buttons

Press the ▲ / ▼ button to adjust the temperature from 16 ° C to 32 ° C; the screen will change each time the button is pressed. Each time you press "▲" the temperature will increase by 1 ° C and each time you press "▼" the temperature will decrease by 1 ° C.

**NOTE: The temperature cannot be set in AUTO and FAN mode, so these two buttons will have no effect.**

## 9. TURBO button

Press this button only in COOL or HEAT mode to select the TURBO function and set the maximum fan speed. When TURBO mode is active, the fan is at maximum speed; When TURBO mode is off, the dispensing speed is restored to the previous state.

## 10. MODE button

Press this button, you can select the running mode as follows:

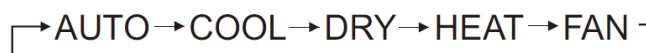

**Note: HEAT mode is not available for cool only units.**

## 11. SLEEP button

By pressing the SLEEP button, the indoor unit light flashes.

After setting the Sleep mode, in the cooling function, the temperature will increase by 1 ° C in one hour, then it will automatically increase by 1 ° C again after another hour.

After setting the Sleep mode, in the heating function, the temperature will decrease by 2 ° C after one hour, then it will automatically decrease by 2 ° C again after another hour.

After 10 hours of operation in SLEEP mode, the air conditioner returns to the previous functions and switches off automatically.

Note: press the MODE button or the ON / OFF button to cancel the setting of the SLEEP function. The SLEEP function cannot be activated in FAN mode.

## 12. SWING button (vertical oscillation)

Press this button to set the automatic vertical swing mode, which allows the outer flaps to swing from top to bottom and vice versa. Press this button again to deactivate the SWING function.

## 13. SWING button (horizontal oscillation)

This function is not available. However, it is possible to direct the air flow manually, by moving the flaps of the indoor unit horizontally.

## 14. Anti-F button

This air conditioner has a special drying and anti-mold function. This function is controlled by the remote control in the COOLING, DRY and AUTO modes.

When the air conditioner is operating in the heating mode, the indoor fan runs for three minutes on weak ventilation before stopping. The purpose of this function is to dry the water inside the evaporator and prevent the formation of mold which can cause the dispersion of a strange odor.

This function is not set by default, it can be freely set and deactivated. The setting method is as follows: when the air conditioner and remote control are off, point the remote control at the unit and press the "Anti-F" button, the unit will beep five times and then indicate that this function is set. Once set, this function remains valid unless the air conditioning is completely switched off or the function is manually deactivated.

To deactivate the function:

1. Turn off the unit.
2. When the air conditioner and the remote control are off, point the remote control at the unit and press this button, the device emits a sound three times and this indicates that the function is disabled.

**NOTE. When this function is active, it is advisable not to restart the air conditioner before it is completely stopped;**

**This function will not be active if the unit is switched off or stopped by the "SLEEP" function.**

## 15. ELE.H/ECO button

a. ELE.H (FUNCTION NOT AVAILABLE)

b. ECO

If you press this button in COOL mode, the unit will activate the ECO mode which has the lowest electricity consumption and that is automatically deactivated after 8h. If you change the mode or turn off the remote control, the function ECO will be automatically canceled. Press the ECO button in ECO mode to exit this mode.

### **Automatic mode (AUTO)**

1. Press the "MODE" button, select the automatic operation mode.
2. By pressing the "SPEED" button, you can select the fan speed from LOW, MID, HIGH, AUTO.
3. Press the "ON/OFF" button, the air-conditioner starts to operate.
4. Press the "ON/OFF" button again, the air-conditioner stops.

### **COOLING/HEATING mode**

1. Press the "MODE" button, select the Cooling or Heating operation mode.
2. By pressing the ▲ or ▼, you can set the temperature from 16°C to 32°C, the display changes as you touch the button.
3. By pressing the "SPEED" button, you can select the fan speed from LOW, MID, HIGH, AUTO.
4. Press the "ON/OFF" button, the air-conditioner starts to operate.
5. Press the "ON/OFF" button again, the air-conditioner stops.

### **FAN mode**

1. Press the "MODE" button, select the fan operation mode.
2. By pressing the "SPEED" button, you can select the fan speed from LOW, MID, HIGH.
3. Press the "ON/OFF" button, the air-conditioner starts to operate in FAN mode.
4. Press the "ON/OFF" button again, the air-conditioner stops.

### **DRY mode**

1. Press the "MODE" button, select the drying operation mode.
2. By pressing the ▲ or ▼ you can set the temperature, the display changes as you touch the button.
3. By pressing the "SPEED" button, you can select the fan speed from LOW, MID, HIGH, AUTO.
4. Press the "ON/OFF" button, the air-conditioner starts to operate.
5. Press the "ON/OFF" button again, the air-conditioner stops.

The remote controller has a backlight which can be turned on by pressing any button for the convenience of operation in darkness. The backlight will be automatically turned off if there is no operation within 10 seconds.

**INTRODUCTION**

The AC system is equipped with remote control technology, with the WI-FI module inside the machine connected to the display panel and the command to run the AC transmitted. The AC system is in constant connection with a wireless router or access point attached to the Internet. Mobile terminals such as smart phones and tablet computers, on which special control software are installed and WI-FI modules successfully configured locally, can be used as remote controllers once they are connected to the Internet.

**DOWNLOAD AND INSTALL THE CONTROL SOFTWARE**

The control software can be downloaded and installed as follows.

- 1. For mobile terminals such as smart phones and tablet (Android 4.1 and iOS 6.0 or above only), search and download “AC Freedom” from Google Play or App store on and install it on your system.
- 2. You may also use your mobile terminal (Android 4.1 and iOS 6.0 or above only) to scan the “QR code” (see Fig.1) with a thirdparty scan tool, which will automatically direct you to the download interface of AC Freedom for you to download and install the software.



For ANDROID



For iOS

Fig.1

Once the control software is installed, enter the “Scanning Interface” (1) for downloading the Home Page.  
(See Fig.2).

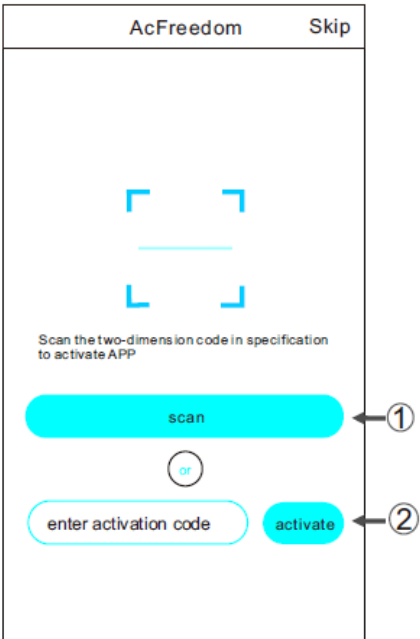

Fig. 2

1. SCAN Function: By clicking “scan” and scanning the QR code on the right (See Fig.3)

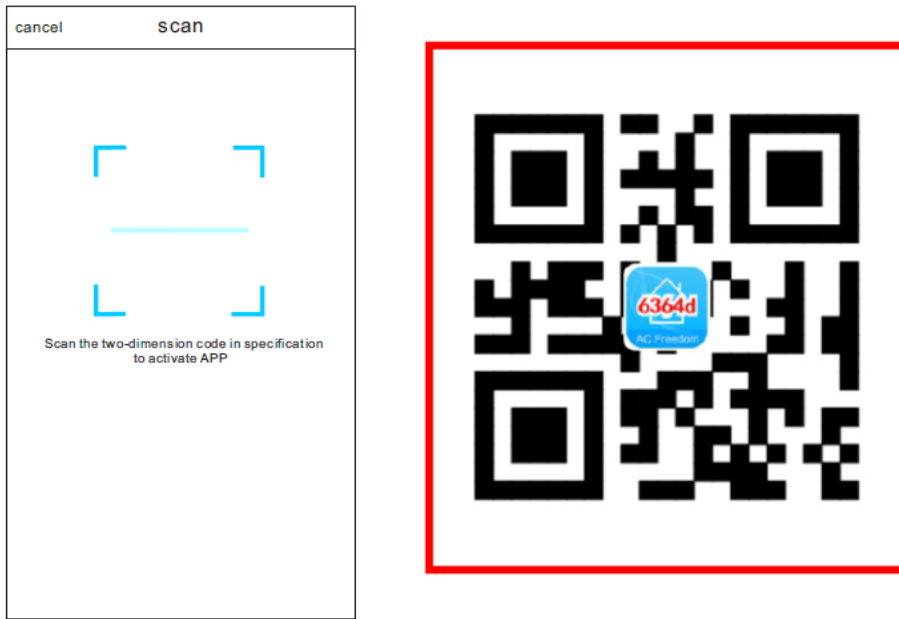
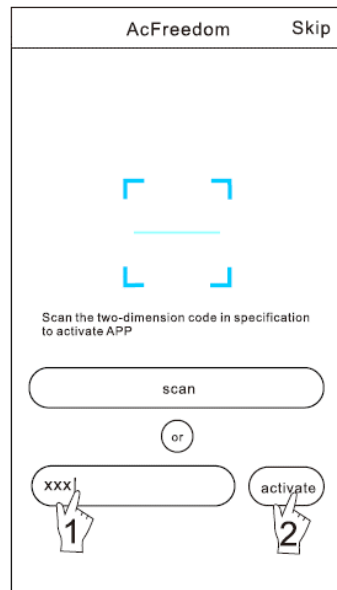

Fig.3

After scanning the QR code, enter the activation code 6364d (image 1) and click on activate (image 2)



## RESET AC WI-FI MODULE

For first time configuration or after changing the connected wireless router is, the WI-FI module inside the air conditioner needs to be reset, following the indications here below:

When AC is running, press “HEALTH” button 8 times, reset successfully after twice “beep” sounds. (see Fig.4)

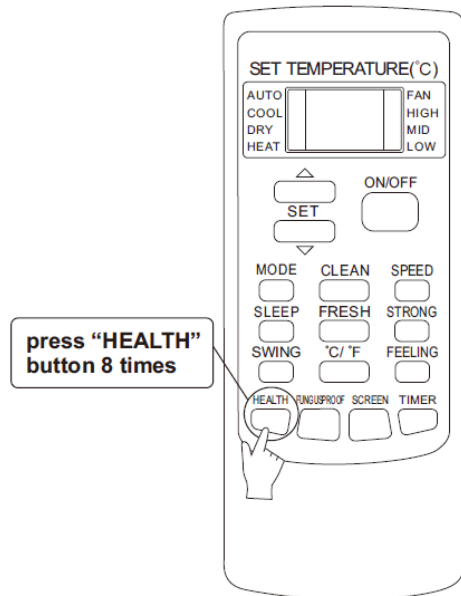

Fig.4

**Note: If the device is not connected successfully, please reset the air conditioner Wi-Fi in the same way.**

### SMARTPHONE, PAD OR OTHER MOBILES TERMINALS CONNECT TO WIFI OR HOTSPOT

Activate the WI-FI function of the mobile device and connect it to a wireless router or an access point

Note: A wireless router is required for the WI-FI function to work.

### CONFIGURATION OF DEVICES

After the control software is downloaded and installed on the mobile terminal, configure the AC devices according to the following figure:

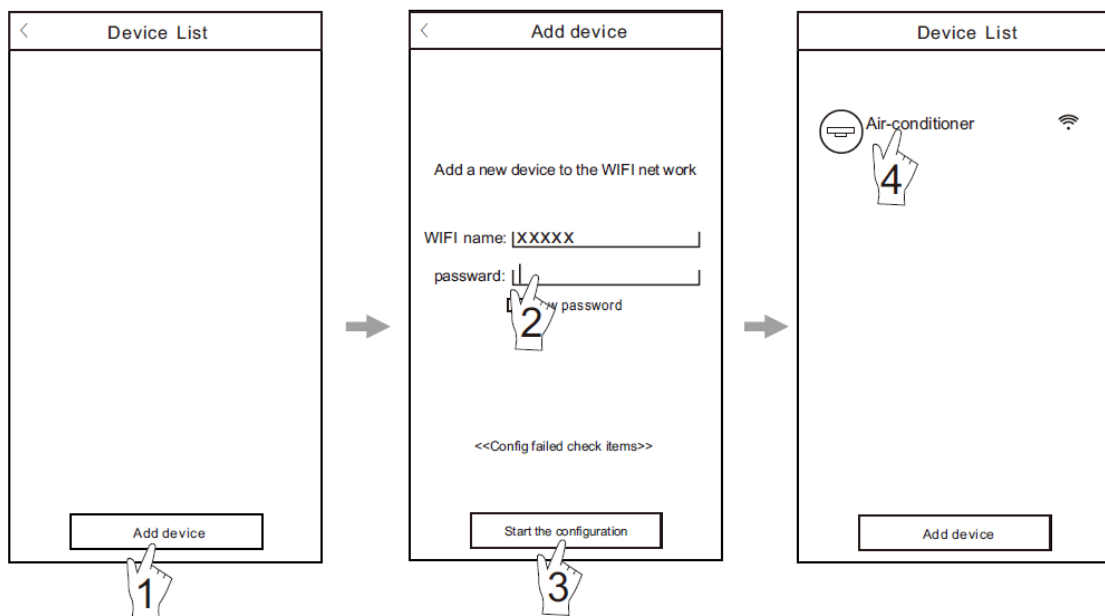

Activate the control software and click "Add device" within 30 minutes after the WIFI module is reset.

the WI-FI name will automatically appear in "Wi-Fi name". Enter the password of the Wi-Fi and click "Start the configuration".

Once the configuration is complete, the "Device List" interface will be automatically returned to and the configured the AC can be seen.



**Note:**

1. For first time configuration or after the connected wireless router or access point is changed, make sure the mobile device is already connected to the wireless router or access point to be paired with the WI-FI module.
2. If the configuration is failed, press “Config faild check items” to check them notes about the failure before reconfigure the AC.

**After the configuration is successful, click the corresponding AC name to enter the control interface for further operation.**

**1. Modify and Lock the Devices**

- In the “Device List” interface, press and hold for more than 0.5 second (for Android system) or press (for IOS system) the icon of an existing device to activate the “Modify the name” interface.
- You can change the name or the icon, to identify different AC devices.
- To lock a device, simply touch the “Locking Device” icon. Once a device is locked, other users won't be able to search for it, thus preventing it from hostile control. After the configurations of the AC device names, icons and locking status are complete, touching “Save” will save and validate them.

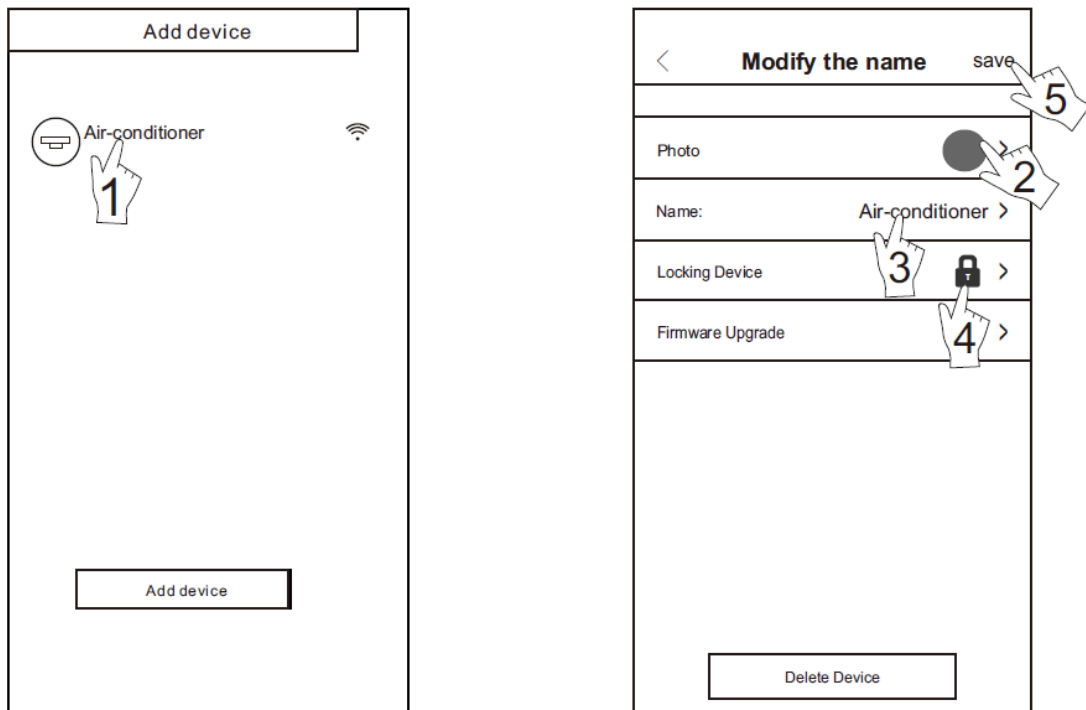

**Fig.5**

**2. Delete an AC under control**

For Android: Click “Delete Device” button under “Modify the name” in Fig.5.  
For IOS: Swipe over the AC name to the left under “Device List” and click “Delete”.

**3. Remote control with wireless router**

Once the wireless router is connected to the Internet, activating the GPRS on the mobile terminal will enable the remote control of the devices.

- The software provides help service through which the users may check the operational instructions of the software and other information.

- Besides, as the operation interface and the function of the software is under constant improvement, we will keep you informed about the subsequent upgrades for your updating.
- As the operation interface may change due to the constant version upgrading, the figures in this manual are for reference only, so please rely on the actual operation interface.

## APPENDIX “A”: CONFIG FAILED CHECK ITEMS

---

1. Please check the Wi-Fi icon on the air conditioner panel, if the icon not display, please contact customer service.
2. Please make sure the mobile phone network under the current router WI-FI environment: Close the mobile phone 3G/4G data connection, to be connected to the router WI-FI pairing.
3. Please check whether the module is reset successfully. For details, see “Reset AC WI-FI module”.
4. Please check the Wi-Fi name of the router, recommended not contain spaces and other non-alphanumeric characters.
5. Please check the Wi-Fi password of the router, not allowed more than 32 bits, recommended not contain spaces and special symbols in addition to letters and numbers.
6. Please check whether the Wi-Fi password input is correct when APP configuration: you can check show password to confirm when input the WI-FI password.

### CLEAN AND CARE



#### WARNING

- Before the cleaning of the air conditioner, it must be shut down and the electricity must be cut off for more than 5 minutes, otherwise there might be the risk of electric shocks.
- Do not wet the air conditioner, which can cause an electric shock. Make sure not to rinse the air conditioner with water under any circumstances.
- Volatile liquids such as thinner or gasoline will damage the air conditioner housing, therefore please clean the housing of air conditioner only with soft dry cloth and damp cloth moistened with neutral detergent.
- In the course of the usage, pay attention to cleaning the filter regularly, to prevent the accumulation of dust which may affect the air conditioner performance. If the service environment of the air conditioner is dusty, correspondingly increase the number of times of cleaning. After removing the filter, do not touch the fin part of the indoor unit with the finger, and no force to damage the refrigerant pipeline.

### CLEAN THE PANEL

---

Clean the front panel of the indoor unit with a cloth and lukewarm water, below 40 ° C.  
Do not disassemble the panel for cleaning.

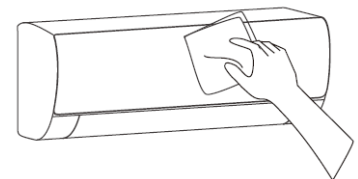

### CLEAN THE AIR FILTER

---

#### Remove the air filter

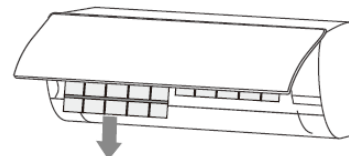
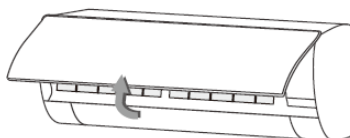

1. Use both hands to open the panel for an angle from both ends of the panel in accordance with the direction of the arrow.

2. Release the air filter from the slot and remove it.

### Clean the air filter

Use a vacuum cleaner or water to rinse the filter, and if the filter is very dirty (for example, with greasy dirt), clean it with warm water (below 45°C) with mild detergent, and then put the filter in the shade to dry in the air.

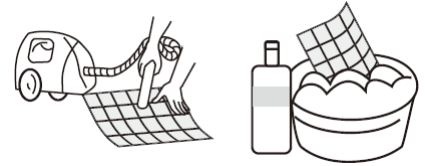

### Mount the air filter

Reinstall the dried filter in reverse order of removal, then cover and lock the panel.



### CHECK BEFORE USING

---

1. Check whether all the air inlets and outlets of the units are unblocked.
2. Check whether there is blocking in the water outlet of the drain pipe, and immediately clean it up if any.
3. Check the ground wire is reliably grounded.
4. Check whether the remote control batteries are installed, and whether the power is sufficient.
5. Check whether there is damage in the mounting bracket of the outdoor unit, and if any, please contact our local service center.

### MAINTENANCE AFTER USING

---

1. Cut off the power source of the air conditioner, turn off the main power switch and remove the batteries from the remote controller.
2. Clean the filter and the unit body.
3. Remove the dust and debris from the outdoor unit.
4. Check whether there is damage in the mounting bracket of the outdoor unit, and if any, please contact our local service center.

## TROUBLESHOOTING

### WARNING

Do not repair the air conditioner by yourself as wrong maintenance may cause electric shock or fire or explode, please contact the authorized service center and let the professionals conduct the maintenance, and checking the following items prior to contacting for maintenance can save your time and money.

PHENOMENON	TROUBLESHOOTING
The air conditioner does not work	<ul style="list-style-type: none"> <li>• There might be power outages.→ <b>Wait until power is restored.</b></li> <li>• Power plug may be loose out from the socket.→<b>The plug in the plug tightly.</b></li> <li>• Power switch fuse may blow.→ <b>Replace the fuse.</b></li> <li>• The time for timing boot is yet to come.→ <b>Wait or cancel the timer settings.</b></li> </ul>
The air conditioner can't run after the immediate start-up after it is shut down	<ul style="list-style-type: none"> <li>• If the air conditioner is turned on immediately after it is turned off, the protective delay switch will delay the operation for 3 to 5 minutes.</li> </ul>
The air conditioner stops running after it starts up for a while	<ul style="list-style-type: none"> <li>• May have reached the setting temperature.→ <b>It is a normal function phenomenon.</b></li> <li>• May be at a defrosting state. → <b>It will automatically restore and run again after defrosting.</b></li> <li>• Shutdown Timer may be set. → <b>If you continue to use, please turn it on again.</b></li> </ul>
The wind blows out, but the cooling/heating effect is not good	<ul style="list-style-type: none"> <li>• Excessive accumulation of dust on filter, blocking at air inlet and outlet, and the excessively small angle of the louver blades all will affect the cooling and heating effect.→ <b>Please clean the filter, remove the obstacles at the air inlet and outlet and regulate the angle of the louver blades.</b></li> <li>• Poor cooling and heating effect caused by doors and windows opening, and unclosed exhaust fan.→ <b>Please close the doors, windows, the exhaust fan, etc.</b></li> <li>• Mode setting is incorrect, and the temperature and wind speed settings are not appropriate.→ <b>Please re-select the mode, and set the appropriate temperature and wind speed.</b></li> </ul>
The indoor unit blows out odor	<ul style="list-style-type: none"> <li>• The air conditioner itself does not have undesirable odor. If there is odor, it may be due to accumulation of the odor in the environment.→ <b>Clean the air filter or activate the cleaning function.</b></li> </ul>
There is sound of running water during the running of air conditioner	<ul style="list-style-type: none"> <li>• When the air conditioner is started up or stopped, or the compressor is started up or stopped during the running, sometimes the "hissing" sound of running water can be heard. → <b>This is the sound of the flow of the refrigerant, not a malfunction.</b></li> </ul>

<p>A slight "click" sound is heard at the of start-up or shut-down</p>	<ul style="list-style-type: none"> <li>• Due to temperature changes, panel and other parts will swell, causing the sound of friction. → <b>This is normal, not a fault.</b></li> </ul>
<p>The indoor unit makes abnormal sound</p>	<ul style="list-style-type: none"> <li>• The sound of fan or compressor relay switched on or off. When the defrosting is started or stop running, it will create sound.→ <b>That is due to the refrigerant flows to reverse direction. They are not malfunctions.</b></li> <li>• Too much dust accumulation on the air filter of the indoor unit may result in fluctuation of the sound. → <b>Clean the air filters in time.</b></li> <li>• Too much air noise when "Strong wind" is turned on. → <b>This is normal, if feeling uncomfortable, please deactivate the "Strong wind" function.</b></li> </ul>
<p>There are water drops over the surface of the indoor unit</p>	<ul style="list-style-type: none"> <li>• When ambient humidity is high, water drops will be accumulated around the air outlet or the panel, etc. → <b>This is a normal physics phenomenon.</b></li> <li>• Prolonged cooling run in open space produces water drops. → <b>Close the doors and windows.</b></li> <li>• Too small opening angle of the louver blades may also result in water drops at the air inlet. → <b>Increase the angle of the louver blades.</b></li> </ul>
<p>During the cooling operation, the indoor unit outlet sometimes will blow out mist</p>	<ul style="list-style-type: none"> <li>• When the indoor temperature and humidity are high, it happens sometimes. → <b>This is because the indoor air is cooled rapidly. After it runs for some time, the indoor temperature and humidity will be reduced and the mist will disappear.</b></li> </ul>

 **WARNING**

- Hear any harsh sound or smell any awful odor during running.
- Abnormal heating of power cable and plug occurs.
- The unit or remote controller has any impurity or water.
- Air switch or leakage protection switch is often disconnected

**NOTICES FOR INSTALLATION**

**Safety operation of flammable refrigerant**

Qualification requirement for installation and maintenance

- All workers who engage with the refrigeration system should bear the valid certification awarded by the authoritative organization, and the qualification recognized by the industry for dealing with the refrigeration system.
- The refrigeration system can only be repaired following the methods suggested by the equipment’s manufacturer.

**Installation notes:**

- The air conditioner mustn’t be used in a room that has running fire or heat sources (such as, working coal gas ware, operating heater).
- Do not drill holes in the circuit or burn the connection pipe.
- The air conditioner must be installed in a room that is larger than the minimum room area. The minimum room area is shown on the following “table a”.
- Leak test is mandatory after installation.

**table a - Minimum room area ( m<sup>2</sup> )**

Minimum room area( m <sup>2</sup> )	Charge amount (kg)	≤1.2	1.3	1.4	1.5	1.6	1.7	1.8	1.9	2	2.1	2.2	2.3	2.4	2.5
	floor location	/	14.5	16.8	19.3	22	24.8	27.8	31	34.3	37.8	41.5	45.4	49.4	53.6
	window mounted	/	5.2	6.1	7	7.9	8.9	10	11.2	12.4	13.6	15	16.3	17.8	19.3
	wall mounted	/	1.6	1.9	2.1	2.4	2.8	3.1	3.4	3.8	4.2	4.6	5	5.5	6
	ceiling mounted	/	1.1	1.3	1.4	1.6	1.8	2.1	2.3	2.6	2.8	3.1	3.4	3.7	4

**Maintenance notes**

- Check whether the maintenance area or the room area meet the requirement of “table a” the unit is only allowed to be operated in rooms that meet these requirements.
- Check whether the maintenance area is well-ventilated. The continuous ventilation status should be kept during the entire operation process.
- Check whether there is a fire source or potential fire source in the maintenance area. Running fire is prohibited in the maintenance area and the “no smoking” sign should be hanged.
- Check whether the warning sign is in good condition, otherwise replace it.

**Welding**

- If it is necessary to cut or weld the refrigerant system pipes in the maintenance procedures, please follow the steps here below:
  - a. Shut down the unit and cut power supply
  - b. Eliminate the refrigerant
  - c. Vacuum with a vacuum machine
  - d. Clean the pipes with the N2 gas
  - e. Cut and weld or
  - f. Bring the unit to a service centre for welding
- The refrigerant should be recycled in a specialized storage tank.
- Make sure there aren’t any free flames near the outlet of the vacuum pump and that it’s well-ventilated.

## Filling the refrigerator circuit

- Use refrigerant filling appliances specialized for R32. Make sure that different kinds of refrigerant don't contaminate one another.
- The refrigerant tank should be kept upright when filling with the refrigerant.
- Stick the label on the system after filling is finished.
- Don't overfill.
- After filling is finished, please test the unit for leakage detection before the operation test; another test for leakage detection should be carried out when the refrigerant is removed.

## Safety instructions for transportation and storage

- Please use a flammable gas detector to check before unloading and opening the container.
- No fire source and no-smoking.
- According to the local rules and laws



Before installing, please contact with local authorized maintenance center, if unit is not installed by the authorized maintenance center, the malfunction may not solved due to discommodious contact.

- The air conditioner must be installed by professionals according to the national wiring rules and this manual.
- Refrigerant leak test must be made after installation.
- To move and install air conditioner to another place, please contact our local special service center.

## SAFETY PRINCIPLES FOR INSTALLATION

---

- Fire prevention device shall be prepared before installation.
- Keep installing site ventilated (open the door and window)
- Ignition source, fire, smoking and mobile phones are not allowed to exist in area where R32 refrigerant located.
- Keep leak detector in working state during the installation.
- If R32 refrigerant leakage occurs during the installation, you shall immediately detect the concentration in indoor environment until it reaches a safe level. If refrigerant leakage affects the performance of the air conditioner, please immediately stop the operation, and the air conditioner must be vacuumed firstly and be returned to the maintenance station for processing.
- Keep electric appliance, power switch, plug, socket, high temperature heat source and high static away from the area underneath sidelines of the indoor unit.
- The air conditioner shall be installed in an accessible location to installation and maintenance, without obstacles that may block air inlets or outlets of indoor/outdoor units, and shall keep away from heat source, inflammable or explosive conditions.
- When installing or repairing the air conditioner and the connecting line is not long enough, the entire connecting line shall be replaced with the connecting line of the original specification; extension is not allowed.
- Use new connection pipe, unless re-flaring the pipe.

## REQUIREMENTS FOR INSTALLATION

---

- Avoid places of inflammable or explosive gas leakage or where there are strongly aggressive gases.
- Avoid places subject to strong artificial electric/magnetic fields.
- Avoid places subject to noise and resonance.
- Avoid severe natural conditions (e.g. heavy lampblack, strong sandy wind, direct sunshine or high temperature heat sources).
- Avoid places within the reach of children.
- Shorten the connection between the indoor and outdoor units.
- Select where it is easy to perform service and repair and where the ventilation good.
- The outdoor unit shall not be installed in any way that could occupy an aisle, stairway, exit, fire escape, catwalk or any other public area.
- The outdoor unit shall be installed as far as possible from the doors and windows of the neighbors as well as the green plants.

## INSTALLATION ENVIRONMENT INSPECTION

---

- Check nameplate of outdoor unit to make sure whether the refrigerant is R32.
- Check the floor space of the room. The space shall not be less than usable space(5m<sup>2</sup>) in the specification. The outdoor unit shall be installed at a well-ventilated place.
- Check the surrounding environment of installation site: R32 shall not be installed in the enclosed reserved space of a building.
- When using electric drill to make holes in the wall, check first whether there is pre-buried pipeline for water, electricity and gas. It is suggested to use the reserved hole in the roof of the wall.

## REQUIREMENTS OF WALL INSTALLATION PLATE

---

- The wall installation plate must meet the relevant national or industrial standards in terms of strength with welding and connection areas rustproofed.
- The wall installation plate and its load carry surface shall be able to withstand 4 times or above the weight of the unit, or 200kg, whichever is heavier.
- The wall installation plate of the outdoor unit shall be fastened with expansion bolt.
- Ensure the secure installation regardless of what type of wall on which it is installed, to prevent potential dropping that could hurt people.

## ELECTRICAL SAFETY REQUIREMENTS

---

- Be sure to use the rated voltage and air conditioners dedicated circuit for the power supply, and the power cable diameter must meet the national requirements.
- When the maximum current of air conditioner is  $\geq 16A$ , it must use the air switch or leakage protection switch equipped with protection devices.
- The operating range is 90%-110% of the local rated voltage. But insufficient power supply malfunction, electrical shock, or fire. If the voltage instability, proposed to increase the voltage regulator.
- The minimum clearance between the air conditioner and the combustibles is 1.5 m.
- The interconnection cord connect the indoor and outdoor units. You must first choose the right cable size before preparing it for connection.
- Cable Types: Outdoor Power Cable: H07RN-F or H05RN-F; Interconnection cord: H07RN-F or H05RN-F;
- Minimum Cross-Sectional Area of Power cable and interconnection cord.



Rated Current of Appliance(A)	Nominal Cross-Sectional Area(mm <sup>2</sup> )
> 3 and ≤ 6	0.75
> 6 and ≤10	1
> 10 and ≤16	1.5
> 16 and ≤25	2.5
> 25 and ≤32	4
> 32 and ≤40	6

- The size of the interconnection cord, power cable, fuse, and switch needed is determined by the maximum current of the unit. The maximum current is indicated on the nameplate located on the side panel of the unit. Refer to this nameplate to choose the right cable, fuse, or switch.
- Note: Core number of cable refer to the detailed wiring diagram adhered on the unit which you purchased.

## INSTALLATION WARNINGS

---

**WARNING:** Make sure that the power supply is disconnected before carrying out any work on the unit.

**WARNING:** Wear appropriate personal protective equipment before carrying out any work on the unit.

**WARNING:** The appliance must be reinstalled in accordance with national system regulations.

**WARNING:** Wiring and installation must only be performed by a qualified technician trained to install, modify, extend and service the unit and perform safety and functionality tests.

**WARNING:** Install a device, master switch or electric plug that will allow all the power from the appliance to be switched off.

The following information is essential for correct unit installation. However, the installer should use his or her experience to install the unit according to specific requirements.

Do not install the unit in locations where there are flammable gases or acid or alkaline substances that may irreparably damage the copper-aluminium heat exchangers or internal plastic components.

Do not install the unit in offices or kitchens where oil vapours mixed with treated air may settle on the exchange coils, reducing performance, or on the unit's internal parts, damaging the plastic components.

**ATTENTION:** For the connection between the units, use only annealed and deoxidized copper pipe for conditioning and refrigeration and insulated with expanded polyethylene of min. 8 mm.

## ELECTRICAL CONNECTION REQUIREMENTS

---

Electrical safety standards must be met when installing the unit.

Use a power supply circuit and circuit breaker that comply with local safety regulations.

Make sure that the power supply matches the requirements of the air conditioner. An unstable power supply or incorrect wiring may result in a fault. Install suitable power cables before switching on the air conditioner.

Correctly connect the live, neutral and earth wires to the power outlet.

Disconnect the power supply before carrying out any work on the electrical circuit or carrying out any safety work. For models with a plug, make sure the plug is easily accessible after installation.

Do not connect the power before installation is complete.

Do not use the appliance if the power cable or plug are damaged. If the power cable is damaged it must be replaced by the manufacturer, retailer or other qualified person to avoid a hazard.

Since the temperature of the cooling circuit is high, keep the interconnecting cable away from the copper pipe.

The unit must be installed in accordance with national wiring regulations.

Installation must only be performed by trained individuals in accordance with regulations.



The unit is charged with a slightly inflammable refrigerant, R32. Improper handling of this gas may expose people and materials to serious damage. More details on this refrigerant are given at the beginning of this manual.

## REQUIREMENTS FOR OPERATIONS AT HEIGHT

---

- When carrying out installation at 2m or higher above the base level, safety belts must be worn and ropes of sufficient strength be securely fastened to the outdoor unit, to prevent falling that could cause personal injury or death as well as property loss.

## GROUNDING REQUIREMENTS

---

- The air conditioner is the class I electrical appliance and must ensure a reliable grounding.
- Do not connect the grounding wire to a gas pipe, water pipe, lightning rod, telephone line, or a circuit poorly grounded to the earth.
- The grounding wire is specially designed and shall not be used for other purpose, nor shall it be fastened with a common tapping screw.
- Interconnection cord diameter should be recommended as per instruction manual, and with type O terminal that meet local standards (internal diameter of type O terminal needs to match the screw size of the unit, no more than 4.2mm). After installation, check the screws whether have been fixed effectively, and there is no risk of loosening.
- An all-pole isolating switch with a minimum contact gap of 3mm in each pole must be connected to the fixed cable.
- Insert a power switch with sufficient power. The air switch must include a magnetic and thermal function to protect against short circuits and overloads. (Attention: Do not use only the fuse to protect the circuit)

<b>Magnetothermal power switch</b>
9K - 8A
12K - 9.5A
18K - 9A
24K - 13A

## OTHERS

- The connection method of the air conditioner and the power cable and the interconnection method of each independent element shall be subject to the wiring diagram affixed to the machine.
- The model and rating value of the fuse shall be subject to the silkscreen on corresponding controller or fuse sleeve.

## INSTALLATION OF INDOOR UNIT

### DIMENSION DRAWING OF INDOOR UNIT INSTALLATION

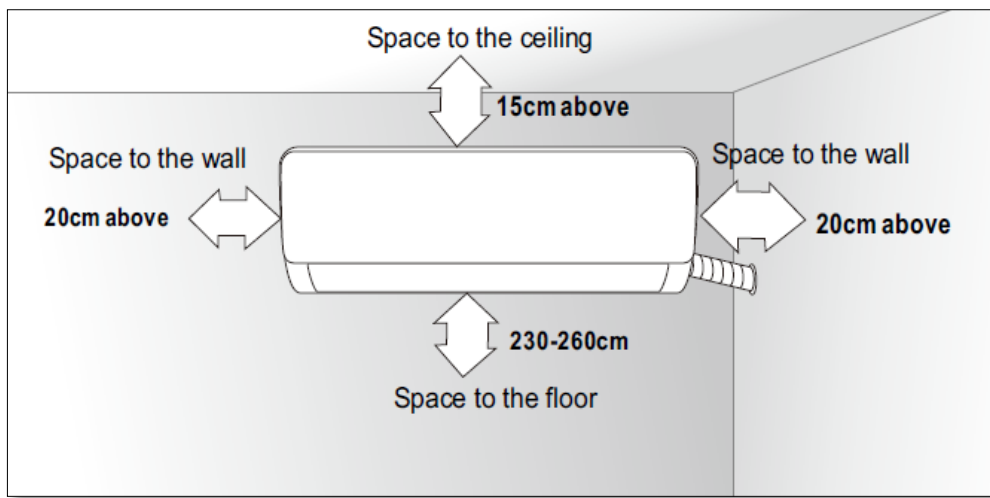

### MOUNTING PLATE

1. The wall for installation of the indoor unit shall be hard and firm, so as to prevent vibration.
2. Use the "+" type screw to fasten the peg board, horizontally mount the peg board on the wall, and ensure the lateral horizontal and longitudinal vertical.
3. Pull the peg board by hand after the installation, to confirm whether it is solid.

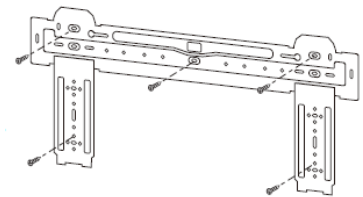

### WALL-THROUGH HOLE

1. Make a hole with an electric hammer or a water drill at the predetermined position on the wall for piping, which shall slant outwardly by 5°-10°.
2. To protect the piping and the cables from being damaged running through the wall, and from the rodents that may inhabit in the hollow wall, a pipe protecting ring shall be installed and sealed with putty.

**Note:** Usually, the wall hole is  $\Phi 60\text{mm} \sim \Phi 80\text{mm}$ . Avoid pre-buried power wire and hard wall when making the hole.

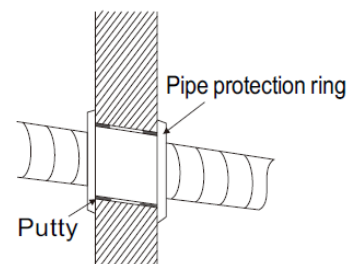

## ROUTE OF PIPELINE

Depending on the position of the unit, the piping may be routed sideway from the left or the right (Fig 1), or vertically from the back (Fig 2) (depending on the pipe length of the indoor unit).

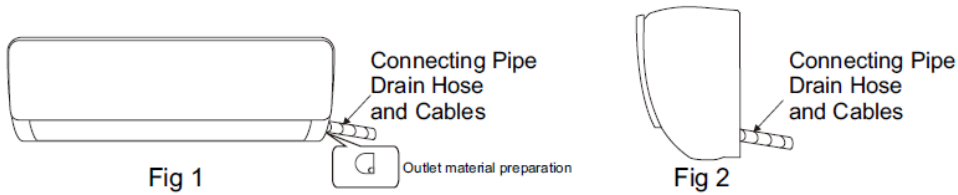

## DRAIN PIPE CONNECTION

1. Remove the fixed part to pull out pipe of indoor machine from the case. Screw the hexagon nut in the left of the joint to the end with your hand.
2. Connect the connecting pipe to the indoor unit: Aim at the pipe center, tighten the Taper nut with fingers, and then tighten the Taper nut with a torque wrench, and the direction is shown in diagram on the right. The torque used is shown in the following table.

**Note:** Carefully check if there is any damage of joints before installation. The joints shall not be reused, unless after re-flaring the pipe.

**Tightening torque table**

The size of pipe(mm)	Torque(N · m)
Φ 6/Φ 6. 35	15~25
Φ 9/Φ 9. 52	35~40
Φ 12/Φ 12. 7	45~60
Φ 15. 88	73~78
Φ 19. 05	75~80

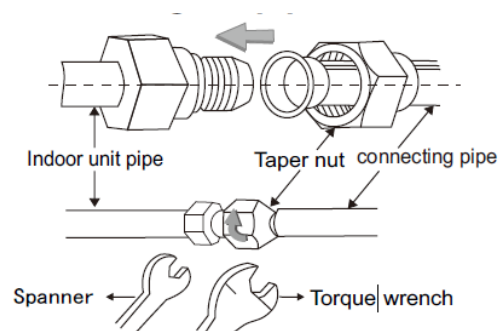

## WRAP THE PIPING

1. Use the insulation sleeve to wrap the joint part the indoor unit and the connection pipe, and then use insulating material to pack and seal insulation pipe, to prevent generation of condensate water on the joint part.
2. Connect the water outlet with drain pipes, and make the connection pipe, cables, and the drain hose straight.
3. Use plastic cable ties to wrap the connecting pipes, cables and drain hose. Run the pipe sloping downward

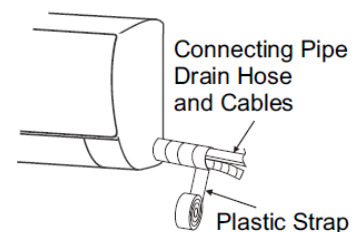

## FIXING THE INDOOR UNIT

1. Hang the indoor unit on the peg board, and move the unit from left to right to ensure that the hook is properly positioned in the peg board.
2. Push toward the lower left side and the upper right side of the unit toward the peg board, until the hook is embedded in the slot and makes a "click" sound.

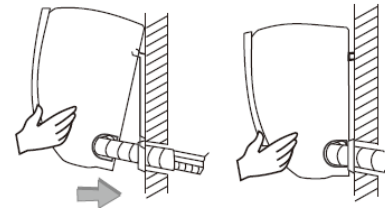

## INTERCONNECTION CORD INSTALLATION

### Connect interconnection cord of indoor unit

1. Open the panel, remove the screw on the wiring cover and then take down the cover.
2. Make the interconnection cord go through the cable-cross hole at the back of indoor unit and then pull it out from the front side. (Some models do not have a signal cable).
3. Remove the wire clip; connect the interconnection cord to the wiring terminal according to the wiring diagram; tighten the screw and then fix the interconnection cord with wire clip.
4. Put wiring cover back and then tighten the screw.
5. Close the panel.

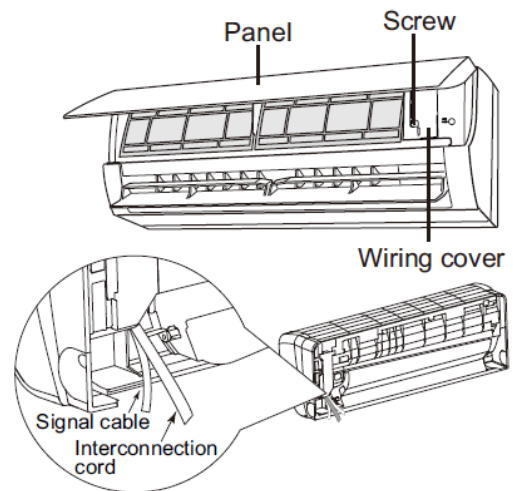

### NOTE:

The diagram are for reference only. Please refer to the detailed wiring diagram adhered on the unit which you purchased.

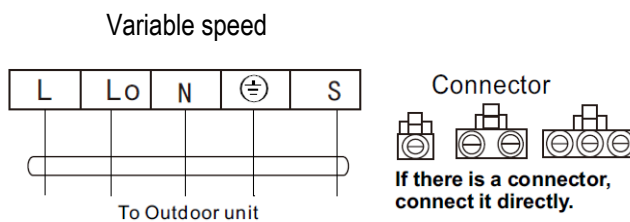

## AFTER INSTALLATION CHECK

1. The screws whether have been fixed effectively, and there is no risk of loosening.
2. Connector of display board whether put in the right place and do not touch the terminal board.
3. Control box cover whether cover tightly.

# INSTALLATION OF OUTDOOR UNIT

## DIMENSION DRAWING OF OUTDOOR UNIT INSTALLATION

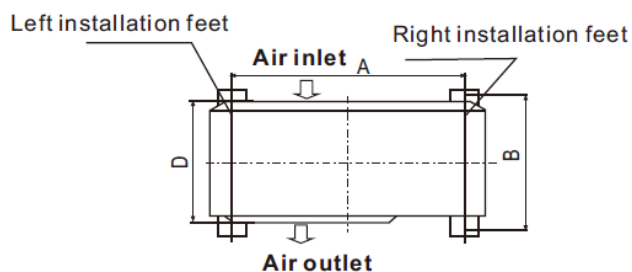
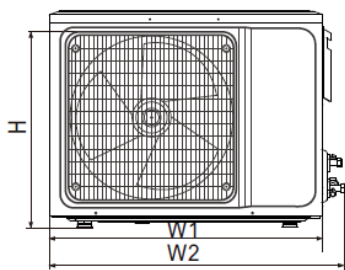
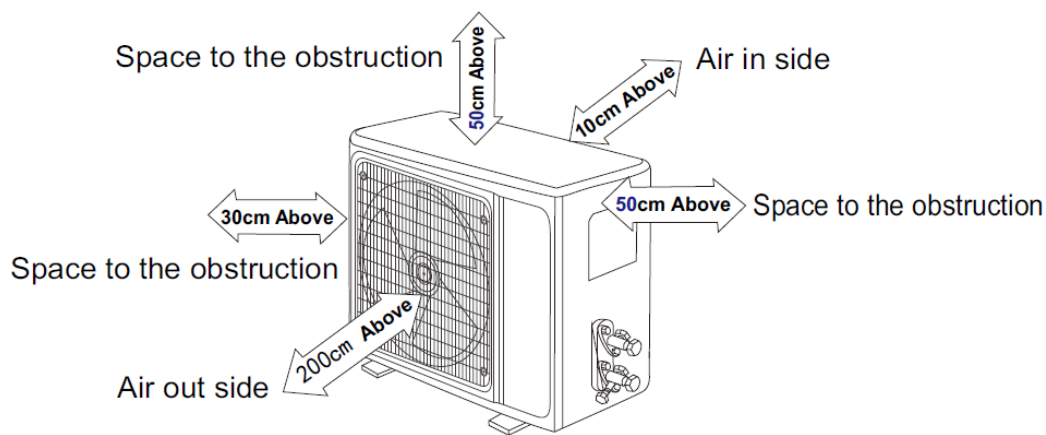

**Installation outdoor unit bolt**

Outdoor Unit Size of Shape W1(W2)*H*D) (mm)	A (mm)	B (mm)
665(710)×420×280	430	280
600(645)×485×260	400	290
660(710)×500×240	500	260
700(745)×500×255	460	260
730(780)×545×285	540	280
760(810)×545×285	540	280
790(840)×550×290	545	300
800(860)×545×315	545	315
800(850)×590(690)×310	540	325
825(880)×655×310	540	335
900(950)×700×350	630	350
900(950)×795×330	535	350
970(1044)×803×395	675	409

## REFRIGERATING CONNECTIONS



Use equipment and connecting pipes suitable for R32 refrigerator.



MODELS	9000	12000	18000	24000
Standard refrigerant charge piping length	7	7	7	7
Maximum length of pipes with additional charge	20	20	25	25
Additional charge g/m	15	15	25	25



Always write the additional refrigerant charge on the data label affixed to the unit outside.

## INSTALL THE CONNECTION PIPE

Connect the Outdoor Unit with Connecting Pipe: Aim the counter-bore of the connecting pipe at the stop valve, and tighten the Taper nut with fingers. Then tighten the Taper nut with a torque wrench.

When prolonging the piping, extra amount of refrigerant must be added so that the operation and performance of the air conditioner will not be compromised

Piping length	Amount of refrigerant to be added		Amount of refrigerant for the unit
≤5M	Not needed		
5-15M	CC≤12000Btu	16g/m	≤1kg
	CC≥18000Btu	24g/m	≤2kg

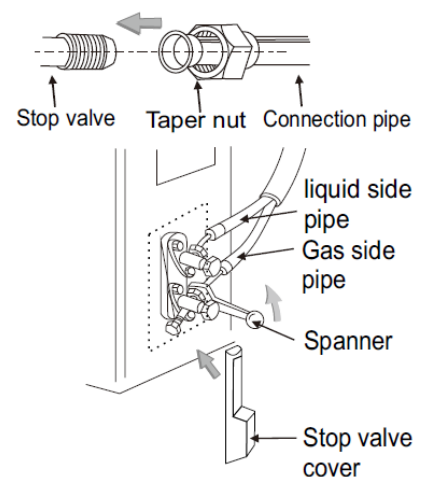

**Note:** 1. This table is for reference only.

2. The joints shall not be reused, unless after re-flaring the pipe.

3. After installation, check the stop valve cover whether be fixed effectively.

## WIRING CONNECTION

- Loosen the screws and remove E-parts cover from the unit.
- Connect the cables respectively to the corresponding terminals of the terminal board of the outdoor unit (see the wiring diagram), and if there are signals connected to the plug, just conduct butt joint.
- Ground wire: Remove the grounding screw out of the electric bracket, cover the grounding wire end onto the grounding screw and screw it into the grounding hole.
- Fix the cable reliably with fasteners (Pressing board).
- Put the E-parts cover back in its original place and fasten it with screws.

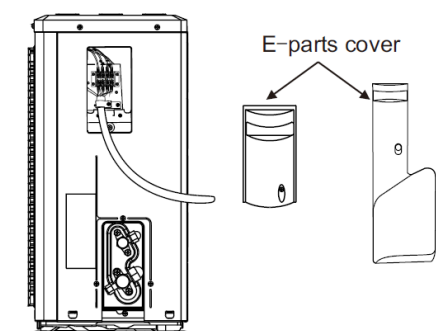

## WIRING DIAGRAM

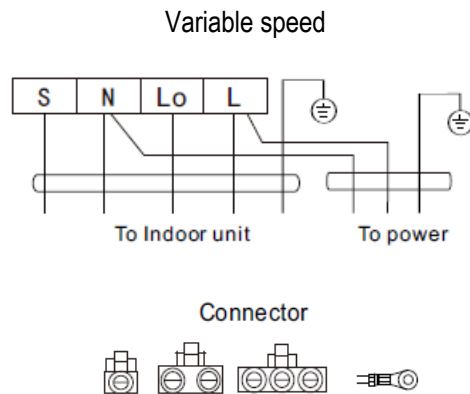

If there is a connector, connect it directly

### NOTE:

The diagram are for reference only. Please refer to the detailed wiring diagram adhered on the unit which you purchased.

## VACUUMING

★Exclusive R32 refrigerant pump must be used in making R32 refrigerant vacuum.

Before working on the air conditioner, remove the cover of the stop valve (gas and liquid valves) and be sure to retighten it afterward (to prevent the potential air leakage)

1. To prevent air leakage and spilling tighten all connecting nut of all flare tubes.
2. Connect the stop valve, charge hose, manifold valve, and vacuum pump.
3. Fully open the handle Lo of the manifold valve and apply vacuum for at least 15 minutes and check that the compound vacuum gauge reads -0.1MPa(-76cmHg).
4. After applying vacuum, fully open the stop valve with a hex wrench.
5. Check that both indoor and outdoor connections are free of air leakage.

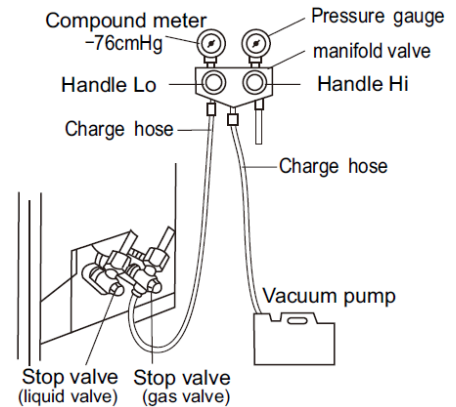

## OUTDOOR CONDENSATION DRAINAGE

When the unit is heating, the condensing water and defrosting water can be out reliably through the drain house.

### Installation:

Install the outdoor drain elbow in  $\Phi 25$  hole on the base plate, and joint the drain hose to the elbow, so that the waste water formed in the outdoor unit can be drained out to a proper plate.

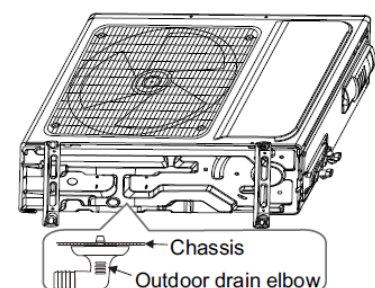



## CHECK AFTER INSTALLATION

---

### ★ Electrical Safety Check

1. If the supply voltage is as required.
2. If there is any faulty or miss connection in each of the power, signal and grounding wires.
3. If the grounding wire of the air conditioner is securely grounded.

### ★ Installation Safety Check

1. If the installation is secure.
2. If the water drain is smooth.
3. If the wiring and piping are correctly installed.
4. Check that no foreign matter or tools are left inside the unit.
5. Check the refrigerant pipeline is protected well.

### ★ Leak test of the refrigerant

Depending on the installation method, the following methods may be used to check for suspect leak, on areas such as the four connections of the outdoor unit and the cores of the cut-off valves and t-valves:

1. Bubble method: Apply of spray a uniform layer of soap water over the suspected leak spot and observe carefully for bubble.
2. Instrument method: Checking for leak by pointing the probe of the leak detector according to the instruction to the suspect points of leak.

Note: Make sure that the ventilation is good before checking.

## TEST OPERATION

---

### Test Operation preparation:

- Verify that all piping and connection cables are well connected.
- Confirm that the valves at the gas side the liquid-side are fully open.
- onnect the power cable to an independent power socket.
- Install batteries in remote control.

Note: Make sure that the ventilation is good before testing.

### Test Operation method:

1. Turn on the power and push the ON/OFF switch button of the remote controller to start the air conditioner.
2. Select COOL, HEAT (not available on cool-only models), SWING and other operation modes with the remote controller and see if the operation is ok.

## MAINTENANCE NOTES

### Attention:

For maintenance or scrap, please contact authorized service centers.

Maintenance by unqualified person may cause dangers.

## APPENDICES

### Piping configuration

Connecting pipe diameter		Additional refrigerant
Liquid pipe (mm)	Gas pipe (mm)	(g/m)
Φ6.35	Φ9.52	20

### Procedure for extending the piping

#### N.B.:

Improper extension of piping is the main cause of refrigerant leaks. Proceed as shown below:

#### 1. Cut the pipe

- Check the length of the pipe based on the distance between the indoor unit and outdoor unit.
- Cut the required pipe using a pipe cutter.

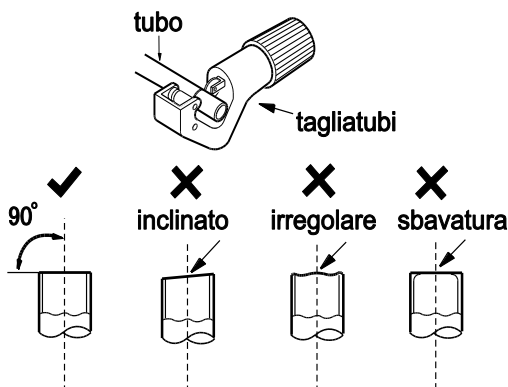

tubo	pipe
tagliatubi	pipe cutter
inclinato	slanted
irregolare	uneven
sbavatura	burred

#### 2. Remove burrs

- Remove burrs with a file, ensuring they do not go into pipe.

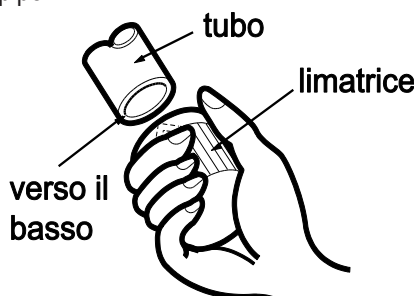

#### 5. Expand the port

Expand the port using a pipe expander.

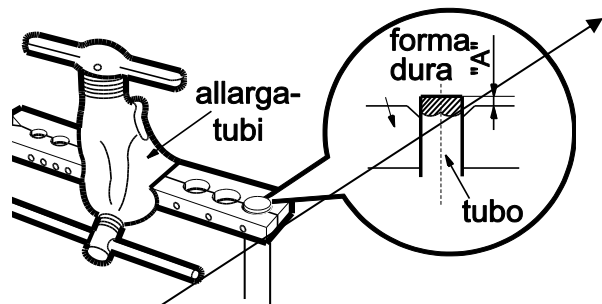

allargatubi	pipe expander
forma dura	hard mould
tubo	pipe

#### N.B.:

"A" varies according to diameter:

Outdoor diameter (mm)	A (mm)	
	Max.	Min.
6.35 (1/4")	1.3	0.7
9.52 (3/8")	1.6	1.0

#### 6. Inspection

Check the quality of the expanded port. If defective, expand the port again following the procedure described above.

tubo	pipe
limatrice	file
verso il basso	downwards

**3. Secure an insulating tube**

**4. Install a union nut**

- Remove the union nut on the indoor connecting pipe and outdoor valve. Install the union nut on the pipe.

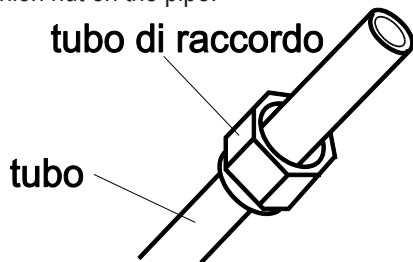

**superficie liscia**

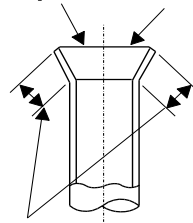

**allargamento imperfetto**

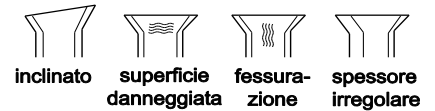

**lunghezza uguale**

superficie liscia	smooth surface
allargamento imperfetto	defective expansion
lunghezza uguale	equal length
inclinato	slanted
superficie danneggiata	surface damaged
fessurazione	cracked
spessore irregolare	uneven thickness

tubo di raccordo	union pipe
tubo	pipe

**REGULATION (EU) No. 517/2014 - F-GAS**

The unit contains R32, a fluorinated greenhouse gas with global warming potential (GWP) = 675. Do not release R32 into the atmosphere.

## Warnings for the refrigeration system specialist

Here are warnings and safety instructions for the maintenance of systems containing flammable refrigerant (repairs should only be carried out by specialists).

a) Any person involved in the work or in the interruption of a refrigeration circuit must be equipped with PEF (European Refrigerators License) as required by the D.P.R. n. 146/2018 implementing Regulation (EU) no. 517/2014.

b) Maintenance should only be performed as recommended by the equipment manufacturer. Maintenance and repairs that require the assistance of other qualified personnel must be performed under the supervision of the person competent in the use of flammable refrigerants.

Before starting work on systems containing flammable refrigerants, safety checks are required to ensure that the risk of ignition is minimized.

c) Checks to be carried out on systems that use flammable refrigerants:

- the charge must be proportionate to the size of the room in which the units containing refrigerant are installed;
- units and ventilation openings must function properly and are not obstructed;
- if an indirect refrigerant circuit is used, the secondary circuit must be checked for the presence of refrigerant;
- the marking on the equipment must be visible and indelible. Illegible markings and signs must be corrected;
- refrigerant piping or components must be installed in a location where they are unlikely to be exposed to any substance that can corrode the component-containing refrigerant, unless the components are constructed from materials that are inherently resistant to corrosion or are adequately protected against corrosion.

d) Checks on electrical devices

Repair and maintenance of electrical components must include initial safety checks and component inspection procedures. If there is a fault that could compromise safety, do not connect the power supply to the circuit until it is satisfactorily resolved. If the fault cannot be remedied immediately, but operation must continue, a suitable interim solution must be used. This must be reported to the owner of the equipment so that all parties are informed.

Initial security checks include:

- Check that the capacitors are discharged: this must be done safely to avoid the risk of sparks;
- Verify that no electrical components and wiring are exposed while charging, restoring or draining the system;
- Check that there is ground continuity.

e) Check for refrigerant leaks

The area should be checked with an appropriate refrigerant detector before and during work, to ensure that the technician is aware of potentially toxic or flammable atmospheres. Make sure that the leak detection equipment in use is suitable for use with all applicable refrigerants, i.e. non-sparking, properly sealed or intrinsically safe.

### Check for R32 refrigerant leaks

Note: Check for refrigerant leakage in an environment where there are no potential sources of ignition. No halogen probe (or any other detector that uses an open flame) should be used.

### Leak Detection Method:

For systems with R32 refrigerant, an electronic leak detection tool is available to detect and leak detection should not be conducted in a refrigerant environment. Make sure the leak detector does not become a potential source of ignition and is applicable to the measured refrigerant. The leak detector must be set for the minimum flammable fuel concentration (percentage) of the refrigerant. Calibrate and adjust to the correct gas concentration (no more than 25%) with the refrigerant used.

The fluid used in leak detection is applicable to most refrigerants. But do not use chloride based solvents to prevent the reaction between chlorine and refrigerants and corrosion of copper piping.

If you suspect a leak, remove all fire from the scene or put out the fire.

If the location of the leak is to be welded, then all refrigerants must be recovered or isolate all refrigerants away from the leak site (using the shut-off valve). Before and during soldering, use OFN to purify the entire system.

f) Presence of fire extinguisher

If hot work is to be performed on the refrigeration equipment or any associated part, adequate fire fighting equipment must be available. It is necessary to have a dry powder or CO2 extinguisher adjacent to the charging area.

#### g) Ventilated area

Make sure the area is outdoors or is adequately ventilated before breaking into the system or performing any hot work. Continuous ventilation must be present during the period in which the work is being carried out. Ventilation should safely disperse the released refrigerant and preferably expel it to the atmosphere.

#### h) Controls on refrigeration equipment

When replacing electrical components, they must be fit for purpose and with the correct specifications. The manufacturer's maintenance and service guidelines should always be followed. If in doubt, consult the manufacturer's technical department for assistance.

#### i) Repairs on sealed components

During repairs to sealed components, all electrical supplies must be disconnected from the equipment being worked on before removing the sealed covers, etc.

If it is absolutely necessary to have an electrical power supply to the equipment during maintenance, then a leak detection device must be placed at the most critical point to warn of a potentially dangerous situation.

Particular attention must be paid to the following to ensure that, by working on the electrical components, the casing is not altered in such a way as to compromise the level of protection. This includes damage to cables, excessive number of connections, terminals not made to original specifications, damage to gaskets, incorrect assembly of cable glands, etc.

- Make sure the appliance is mounted securely.
- Ensure that gaskets or sealing materials are not degraded to the point that they no longer serve the purpose of preventing the entry of flammable atmospheres. Replacement parts must conform to the manufacturer's specifications.

NOTE: The use of silicone sealant can inhibit the effectiveness of some types of leak detection equipment. Intrinsically safe components do not need to be isolated before working on them.

#### l) Repair of intrinsically safe components

Do not apply permanent inductive or capacitive loads to the circuit without ensuring that it does not exceed the voltage and current allowed for the equipment in use.

The intrinsically safe components are the only ones that can be worked on in the presence of a flammable atmosphere. The test equipment must be of the correct evaluation.

Replace components only with parts specified by the manufacturer. Other parts can cause the refrigerant to ignite in the atmosphere due to a leak.

#### j) Wiring

Verify that the wiring is not subject to wear, corrosion, excessive pressure, vibration, sharp edges, or other adverse environmental effects.

The control must also take into account the effects of aging or continuous vibrations from sources such as compressors or fans.

#### k) Deactivation

Before carrying out this procedure, it is essential that the technician is fully familiar with the equipment and all its details. Good practice is recommended that all refrigerants be recovered safely. Before the task is performed, a sample of the oil and refrigerant must be taken in case an analysis is required before reuse of the recovered refrigerant. It is essential that electricity is available before the start of the activity.

A. Become familiar with the equipment and its operation.

B. Electrically isolate the system.

C. Before attempting the procedure, make sure that:

- mechanical handling equipment is available, if required, for handling the refrigerant cylinders;
- all personal protective equipment is available and used correctly;

- the recovery process is supervised at all times by a competent person;
  - Recovery equipment and cylinders comply with appropriate standards.
- D. If possible, drain the refrigerant system.
- E. If vacuum is not possible, make a manifold so that the refrigerant can be removed from the various parts of the system.
- F. Make sure the cylinder is placed on the scale before recovery takes place.
- G. Start the recovery machine and operate according to the manufacturer's instructions
- H. Do not overfill the cylinders. (Not more than 80% by volume of liquid charge).
- I. Do not exceed, even temporarily, the maximum working pressure of the cylinder.
- J. When the cylinders have been filled correctly and the process is complete, ensure that the cylinders and equipment are promptly removed from the site and that all isolation valves on the equipment are closed.
- K. Recovered refrigerant should not be charged to another refrigeration system unless it has been cleaned and checked.

#### I) Labeling

The equipment must be labeled indicating that it has been shut down and drained of refrigerant. The label must be dated and signed. For appliances containing flammable refrigerants, make sure there are labels on the appliance indicating that the appliance contains flammable refrigerant.

#### Recovery

When removing refrigerant from a system, whether for maintenance or decommissioning, it is recommended that all refrigerants be removed safely.

When transferring refrigerant to cylinders, ensure that only appropriate refrigerant recovery cylinders are used. Make sure the correct number of cylinders are available to maintain full system charge. All cylinders to be used are designated for the recovered refrigerant and labeled for that refrigerant (i.e. special cylinders for recovering refrigerant). The cylinders must be complete with pressure relief valve and relative shut-off valves in good working order. Empty recovery cylinders are evacuated and, if possible, cooled before recovery takes place.

If compressors or compressor oils need to be removed, make sure they have been evacuated to an acceptable level to ensure that flammable refrigerant does not remain within the lubricant. The evacuation process must be carried out before returning the compressor to suppliers. To speed up this process, only electrical heating of the compressor body must be used. When oil is drained from a system, it must be done safely

#### Work procedure

The work must be carried out according to a controlled procedure in order to minimize the risk of the presence of flammable gas or vapor during the execution of the work.

##### 2. General work area

All maintenance personnel and others working in the local area should be educated on the nature of the work being performed. Work in confined spaces must be avoided. The area around the work area must be sectioned. Ensure that conditions within the area have been secured by the control of flammable material.

##### 3. No ignition sources

No person carrying out work in relation to a refrigeration system involving exposure to piping must use sources of ignition in a way that creates the risk of fire or explosion. All possible sources of ignition, including cigarette smoke, must be kept sufficiently far from the place of installation, repair, removal and disposal, during which the refrigerant may possibly be released into the surrounding space. Before starting work, the area around the equipment must be checked to ensure that there is no risk of flammability or ignition hazards. "No smoking" signs must be displayed.

#### Removal and evacuation

When breaking into the refrigerant circuit to make repairs or for any other purpose, conventional procedures must be used. However, for flammable refrigerants it is important to follow the best procedures as there is a risk of flammability.

The following procedure must be followed:

- remove the refrigerant;
- purge the circuit with inert gas; evacuate;
- purge again with inert gas;
- open the circuit by cutting or brazing.

The refrigerant charge must be recovered in the correct recovery cylinders.

For appliances containing flammable refrigerants, the system must be flushed with OFN to make the unit safe. You may need to repeat this process several times. Compressed air or oxygen must not be used for purging refrigerant systems.

For appliances containing flammable refrigerants, flushing must be achieved by breaking the vacuum in the system with OFN and continuing to fill until the operating pressure is reached, then discharging to the atmosphere and finally lowering the vacuum. This process must be repeated until there is no more refrigerant in the system. When the final OFN charge is used, the system must be vented to atmospheric pressure to allow the work to be carried out. This operation is absolutely essential if you want to carry out brazing operations on the pipes.

Make sure that the vacuum pump outlet is not close to ignition sources and that ventilation is available.

#### Charging procedures

In addition to conventional charging procedures, the following requirements must be followed.

- Make sure that contamination of different refrigerants does not occur when using charging equipment. Hoses or lines should be as short as possible to minimize the amount of refrigerant they contain.
- The cylinders must be kept upright.
- Make sure the refrigeration system is grounded before charging the system with refrigerant.
- Label the system when charging is complete (if not already done).
- Be very careful not to overfill the refrigeration system.

Before recharging the system, it must be pressure tested with the appropriate purge gas.

The system must undergo a leak test upon completion of the charge but prior to commissioning. A subsequent leak test must be carried out before leaving the site.

**GREENSTYLE PLUS 9000 UE - Kg. 0,56 = 0,378 Tonn CO2 equiv.**

**GREENSTYLE PLUS 12000 UE - Kg. 0,56 = 0,378 Tonn CO2 equiv.**

**GREENSTYLE PLUS 18000 UE - Kg. 0,80 = 0,540 Tonn CO2 equiv.**

**GREENSTYLE PLUS 24000 UE - Kg. 1,30 = 0,878 Tonn CO2 equiv**



[www.argoclima.com](http://www.argoclima.com)