

## Network adapter with Access function

### Web UI

An internal WEB user interface for device management: Connected devices are deployed using the Ouflex BA Tool. Ethernet connection (DHCP / Fixed IP), with Access function.

### OUMAN ACCESS

Access is a service offered by Ouman for creating a secure VPN connection between the device and the Ounet online monitoring service. With the service, the device can also be operated remotely through an internet browser. The service is included in the price throughout the device's life cycle.



### Local Trend saving

**M-LINK is a media converter for converting Ouman's Modbus (RTU/ TCP) based devices, or those of other manufacturers, to the Ouman system. Dynamic process diagrams can be done locally for the device, which can be used to monitor the activities of the object smoothly. Process images are created either with the OuflexBATool tool or directly via a browser on the device. The device can be linked to an existing internet connection, through which the device creates a secure connection between M-LINK and the Ouman Ounet online monitoring service.**

If there is no internet connection, you can use, for example, an Ouman 4G modem, which provides an immediate connection to the destination. M-LINK can be used at the same time as an interface device to the Ounet control room, as well as locally from the WEB user interface. The M-LINK WEB interface works over the Internet and locally on a local area network without an Internet connection.

### Kommunication PROTOCOLS

- Modbus RTU
- Modbus TCP/IP

### CONNECTIONS

- Modbus RTU connection using screw connectors:
- Modbus TCP connection RJ45
- With a C connector (RJ45), it is also possible to connect (one) Ouman controller (Ouflex M, Ouflex M BA, S203, C203, H23) + GSM Modem when using S203 or C203.

Possible to make point transfers from one device to another (Modbus RTU / Modbus TCP) (requires the Ouflex BA Tool)

# LED functions

- INIT/ERR
- LINK
- C COM
- RS-485 COM

| LED indicator light | Description of the function  |
|---------------------|--|
| INIT/ERR            | <ul style="list-style-type: none"><li>• The red indicator light flashes when the device starts up and then light turns off.</li><li>• If the LED remains blinking:<ul style="list-style-type: none"><li>- C-Extension Bus is enabled and no device connected to RJ45 connector<br/>→ Connect the device to either connector or disable the expansion bus via the WEB interface (see page10).</li><li>- The programmed RTU bus device is not responding or there are active alarms on the device/devices.</li></ul></li><li>• The red light remains solid → Contact your dealer</li></ul> |
| LINK                | <ul style="list-style-type: none"><li>• A green indicator light indicates the status of network connection.</li><li>• When the signal light is off, there is no connection with the LAN.</li><li>• When the signal light is off most of the time but blinks occasionally, the LAN connection is operational.</li><li>• When the signal light is on almost constantly but is turned off for brief moments, the Internet connection is operational.</li><li>• When the signal light is constantly on, the Access connection is operational.</li></ul>                                      |
| C COM               | <ul style="list-style-type: none"><li>• When the signal light blinks, M-LiNK is receiving data from a device connected in the C connector.</li></ul>   |
| RS-485 COM          | <ul style="list-style-type: none"><li>• When the signal light blinks, M-LINK is receiving data from the Modbus RTU bus.</li></ul>  |

# Content

|   |           |
|---|-----------|
| <b>1 Installation and connections .....</b>                 | <b>4</b>  |
| <b>2 Establishing a browser connection to M-LINK .....</b>  | <b>6</b>  |
| <b>3 Ounet connection of an Ouman unit controller .....</b> | <b>7</b>  |
| <b>4 Connecting several devices to M-LINK .....</b>         | <b>8</b>  |
| <b>5 Modbus RTU wiring diagram .....</b>                    | <b>9</b>  |
| <b>6 Connecting a bus device to an M-LINK device .....</b>  | <b>10</b> |
| <b>7 Modbus TCP/IP communication .....</b>                  | <b>11</b> |
| <b>8 M-LINK WEB UI .....</b>                                | <b>13</b> |
| 8.1 <i>Chart editor</i> .....                               | 14        |
| 8.2 <i>Alarms</i> .....                                     | 18        |
| 8.3 <i>Trends</i> .....                                     | 19        |
| 8.4 <i>System settings</i> .....                            | 20        |
| 8.5 <i>Device management</i> .....                          | 25        |
| 8.6 <i>Logs</i> .....                                       | 26        |
| <b>9 Technical information .....</b>                        | <b>28</b> |

# 1 Installation and connection

## Installation:

Fixed on a DIN rail.

## Commissioning of M-LINK's connections:

1. The network cable is connected in M-LINK's Ethernet connection.
- C. M-LINK is connected to the connector of an M-LINK-compatible device using a direct RJ45 cable. M-LINK's power supply is available at this C connector. If this connection is not used, the operating voltage 24VAC or 24VDC is connected directly to terminals 1 and 2.



- With a C connector (RJ45), it is also possible to connect (one) Ouman controller (Ouflex M BA, S203, C203, H23)
- and also GSM Modem when using S203 or C203.

(Only the Ouflex M BA device is supported by the local WEB interface via C-Bus)

## 2. M-LINK's terminal strips

2

### External power supply (24VAC or 24VDC) for M-LINK.

An external power supply is used if no M-LINK-compatible device is connected to M-LINK's C connector.

### Modbus RTU bus

- Modbus RTU connection using screw connectors)
- Modbus TCP connection RJ45
- Capacity: Max 10 devices or 2,000 points, RTU + TCP
- Possible to make point transfers from one device to another (Modbus RTU / Modbus TCP) (requires the Ouflex BA Tool)

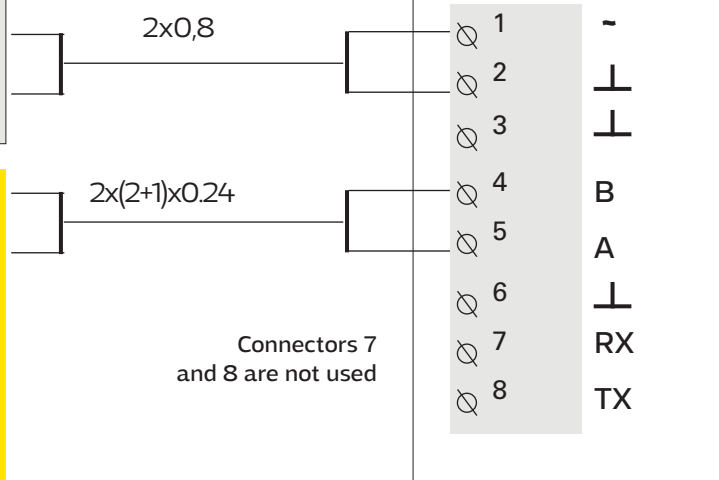

## Kommunication protocols:

- Modbus RTU
- Modbus TCP/IP

## M-LINK C connection



These connections are only used with Ouman's own devices fitted with an RJ45 connector. The C connections are identical. You can connect M-LINK-compatible Ouman device in one connector and a GSM modem (GSMMOD) in the other for text message communication (C203 and S203 only). When connecting an Ouman device to a C connector, make sure that Access is on (System settings → Network settings → Access "On").

### C203 or Ouflex C



RJ45 connector

#### Features

- Connecting an Ouman device to M-LINK interfaces, importing network features
- Conversion of the registers to Modbus RTU and TCP/IP buses
- The platform version of a connected Ouman device can be remotely updated
- Downloading applications via an LAN / remote connection
- Process monitoring of devices with a Ouflex C platform
- **The power supply of an M-LINK device comes from an Ouman device connected in the C connector**

### Ouflex M or Ouflex M BA

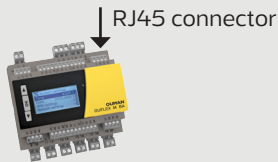

RJ45 connector

#### Supported Ouman devices:

- C203 v.1.5.1 (the older versions must be updated to obtain M-LINK support)
- Ouflex C (Platform v. 4.0.0 →)
- Ouflex M (Platform v.1.2.0→)
- Ouflex M BA (Platform v.1.0.0→)
- S203 (v. 1.2.0 →)

### S203 or H23



RJ45-I connector

## Modbus RTU bus

Older Ouman devices, such as EH-203 and EH-105, as well as third-party devices, can be connected via this connection.



#### Features

- Connecting a device to M-LINK interfaces
- Resetting the alarm registers of EH-203 and EH-105 devices via Ounet

#### Supported devices

- All Ouman devices with MB-RTU support
- All third-party devices with MB-RTU support

## Modbus TCP/IP bus

The devices can communicate with the MB TCP/IP network via this connection (the general network cabling can be utilised).

#### Features

- Connecting a device to M-LINK interfaces

#### Supported devices

- All Ouman devices with MB-TCP/IP support
- All third-party devices with MB-TCP/IP support

## 2 Establishing a browser connection to M-LINK

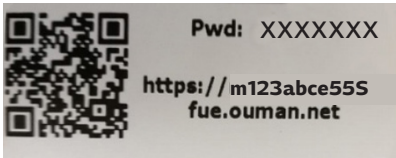

**M-LINK** **OUMAN**

Login

Username

Password

LOGIN

**If you have a QR reader, read the QR code in the label on the M-Link device.**

Enter the user ID and password. The device has three user ID levels: "service", "user" or "viewer". "Service" level users have the most extensive rights.

Username = service, user or viewer. The password is shown in the label at the end of the M-LINK device. The password can be changed on the "Update" tab. For further information on browser use, see p. 13

### M-LINK device in an internal network

**If the device is in an internal network, you can establish a browser connection to the device by reading the QR code or by entering the www address in the label.**

The address is in the format https:// and enter then the web address on the label so that the "ouman.net" is replaced by text "ouman.local". For example, https://m123abce55Sfue.ouman.local.

**If you have the Ouflex BA Tool in your pc, you can use the SCAN function, which searches for devices on the same LAN and displays them in a list. You get a device connection, when you select a device from the SCAN list and click "Open Connection". You can download files, settings, diagrams from the tool to the device and vice versa.**

### M-LINK device in a public network

**If the device is in a public network, you can establish a browser connection to the device by reading the QR code or by entering the Access-IP address. The address is shown in the label on the M-LINK device.**

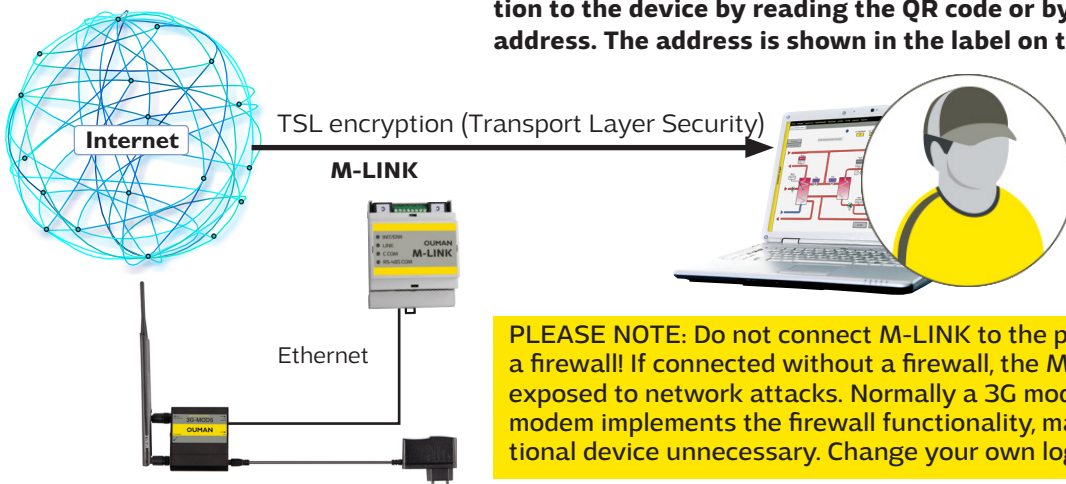

Browser use requires logging in. The password can be changed.

**PLEASE NOTE: Do not connect M-LINK to the public Internet without a firewall! If connected without a firewall, the M-LINK device can be exposed to network attacks. Normally a 3G modem, an ADSL/WDSL/cable modem implements the firewall functionality, making a separate additional device unnecessary. Change your own login password.**

### 3 Ounet connection of an Ouman unit controller

When you want to read the information of one M-LINK-compatible device in a browser, connect the device directly to M-Link's C connector. This also allows you to perform a remote update on the device, if required.

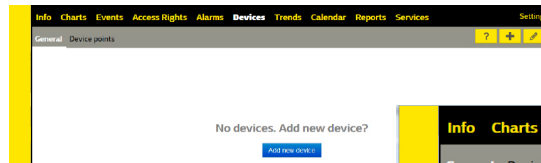
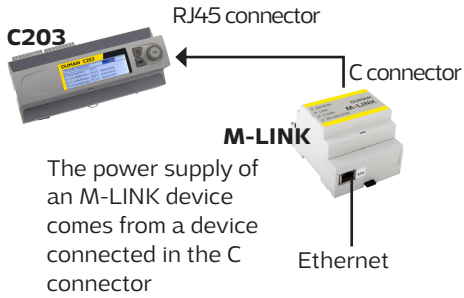

| Device name | Point ID | Connection status | Type |
|-------------|----------|-------------------|------|
| C203_4MB    | v.1.5.1  | Online            | C203 |

When connecting an Ouman device to a C connector, check in the device's network settings (System settings) that:

- The DHCP setting is "ON" (If you change the setting, select "Update network settings")
- The port address is the same as in Ounet (Modbus TCP/IP → Port 502)
- The Access setting is "ON"
- In SNMP settings, the Access IP address is given as the IP address, and "ON" is selected as the "Function on" setting.

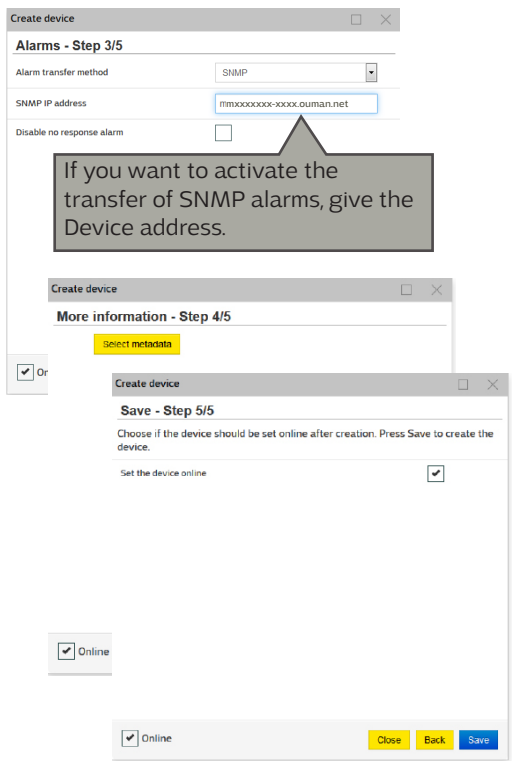
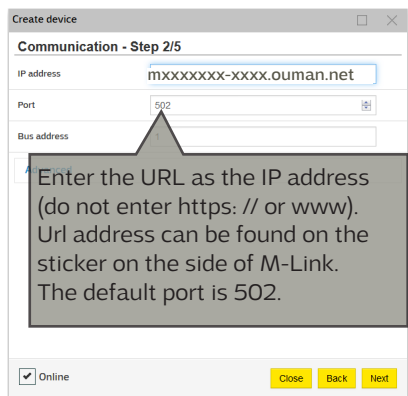
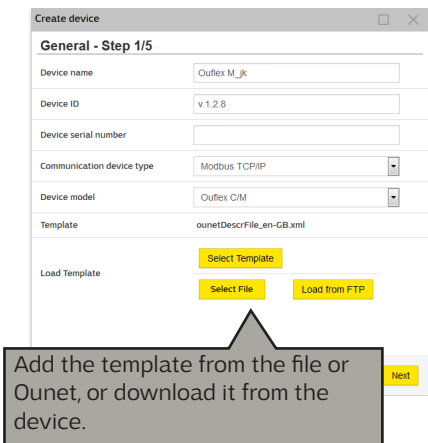

**Note:** You must also activate the SNMP function from the device connected in the C connector (System settings → Network settings → SNMP → Active "On".)

| Device name | Point ID | Connection status | Type       | Address                 | Port | Slave ID | 'No response' alarms |
|-------------|----------|-------------------|------------|-------------------------|------|----------|----------------------|
| Ouflex M_jk | v.1.2.8  | Online            | Ouflex C/M | mxxxxxxx-xxxx.ouman.net | 502  | 1        | 0                    |

## 4 Connecting several devices to M-LINK

### C bus connector / connectors (RJ45)

- **ONLY ONE** Ouman device can be connected to one of the RJ45 connector (Ouflex M / Ouflex M BA, S203, C203 or H23).
- M-LINK receives its operating voltage via the connected device. (An external operating voltage source is not required.)
- The firmware (version) of the device connected via the C bus can be updated remotely, where necessary.
- The application of the device connected via the C bus can be uploaded remotely (Ouflex M BA and Ouflex M, if the Ouflex M device has a memory card in place).
- Through the device connected to the C bus, you can read Modbus devices that have been connected under it as Modbus RTU slave devices. (Ports 503 & 504)

### Modbus RTU (screw connectors)

- It is possible to connect several Modbus devices to the RTU bus (max. 10 devices or 2000 points).
- When M-LINK is the Modbus master device, point transfers can be made between the devices.

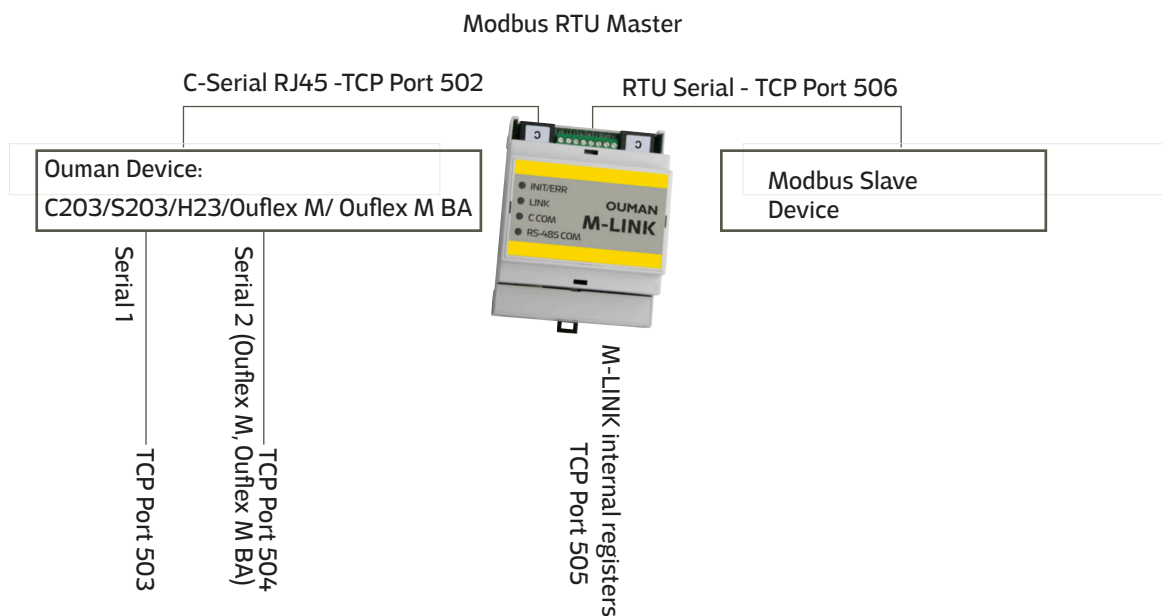



## 5 Modbus RTU wiring diagram

If you want to read the data of several devices using a browser, connect the devices to the RTU bus. You can bring bus devices up to Ounet using the M-LINK. We recommend that you connect a maximum of 10 devices to the RTU bus.

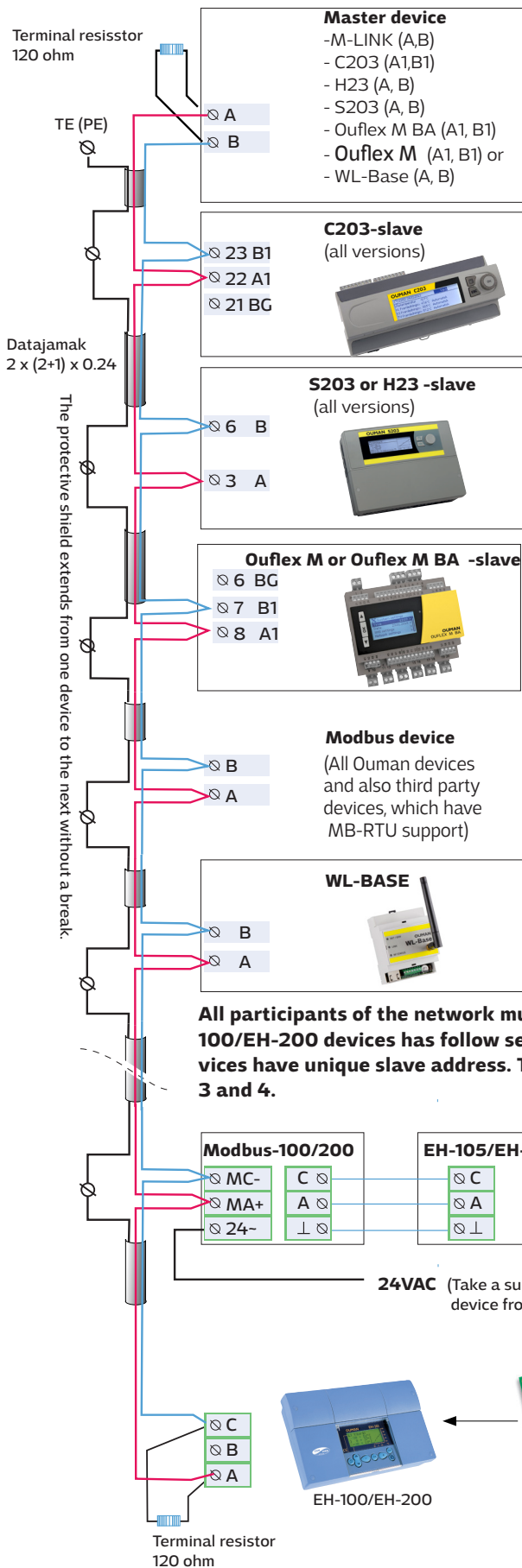

**Attention! Ouman Ouflex C devices have the following factory default settings:**

**Modbus slave address 10**

**Baud rate 9600**

**Data bits 8**

**Stop bits 1**

**Parity None**

**If the Modbus-RTU bus has multiple devices, the Modbus slave addresses must be unique.**

**Do changes to the controller:**

**System settings → Network settings → Modbus RTU settings.**

A twisted pair cable must be used for network cabling, e.g., Datajamak 2x(2+1)x0.24. The network must be like a chain, with the cable going from one device to the next and stubs are not recommended (max. length of stub 0.5m). The maximum length of the whole network is 1200m. **120 ohm terminating resistors are connected to both ends of the network.**

The twisted pair cable's protective shield can be connected if needed in to protective earth in order to eliminate interference. The connection is made only from the other end of the protective shield, e.g., always from the cable leaving the controller.

**All participants of the network must have the same baud rate, data bits, stop bits and parity. EH-100/EH-200 devices has follow settings: data bits 8, stop bits 1 and parity "None". Be sure that devices have unique slave address. The address of EH-200/EH-105 devices will be set by DIP switches 3 and 4.**

| DIP1 | DIP2 | Biassing resistors |
|------|------|--------------------|
| 0    | 0    | Not in use         |
| 1    | 1    | In use             |

If EH-200/EH-100 is the first or last device in the bus, biassing resistor must be taken into use

| DIP3 | DIP4 | Baud rate |
|------|------|-----------|
| 0    | 0    | 4800      |
| 1    | 0    | 9600      |
| 0    | 1    | 19200     |
| 1    | 1    | 38400     |

| DIP switches, 1 = ON |                 |     |     |      |
|----------------------|-----------------|-----|-----|------|
| DIP 5                | DIP 9 = Address |     |     |      |
| 1                    | 0               | 0   | 0   | = 1  |
| 0                    | 1               | 0   | 0   | = 2  |
| 1                    | 1               | 0   | 0   | = 3  |
| 0                    | 0               | 1   | 0   | = 4  |
| 1                    | 0               | 1   | 0   | = 5  |
| ...                  | ...             | ... | ... | ...  |
| 1                    | 1               | 1   | 1   | = 31 |

## 6 Connecting a bus device to an M-LINK device

The M-LINK device can read the device points of a device connected to its own Modbus/RTU bus. The device points may be physical measurement results, settings, controls etc. The read points can be brought up to Ounet or other SCADA systems or transferred as a point transfer to another device via the TCP/IP bus. The device whose device points are read, is added as a bus device using the OuflexTool.

1. Open OuflexTool. Select M-Link.
2. Select "Devices"
3. Select Modbus master (SerialPort2)
4. Select "Add device".
5. If the device you want to add is on the list, select the device.
6. Just select points from the list of points you want to read
7. If the device cannot be found from the list, select "New device" → name the device → and enter a unique device address

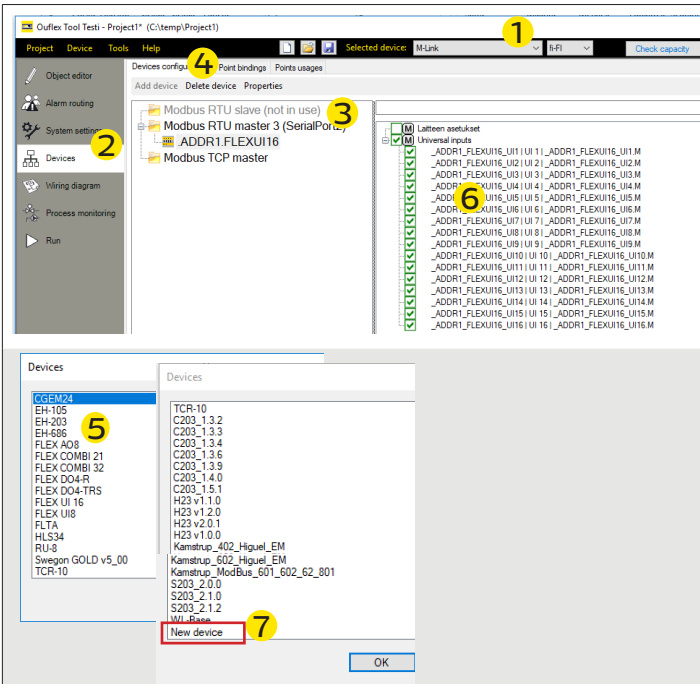

7. If the device cannot be found from the list, select "New device" → name the device → and enter a unique device address

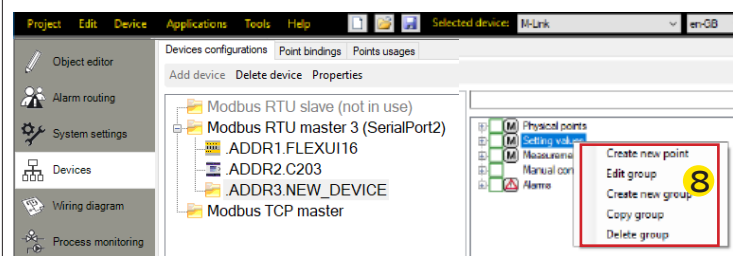

8. Add the new device's points to the points list. Create the points for the device by right-clicking a group in the point list.

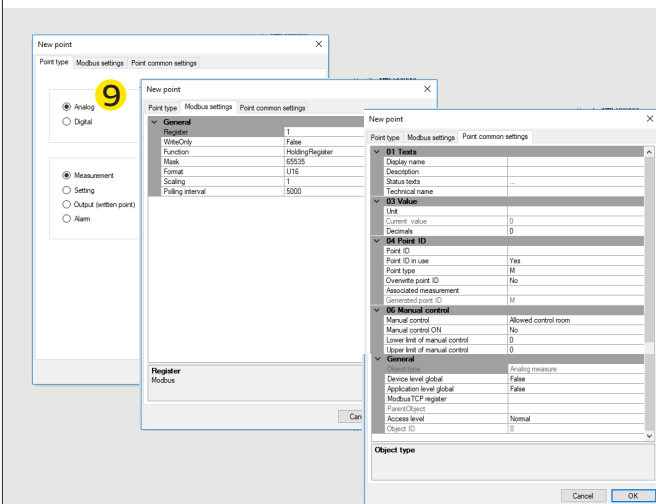

9. Fill out the form data, "Point Type," "Modbus settings," and "Point common settings".

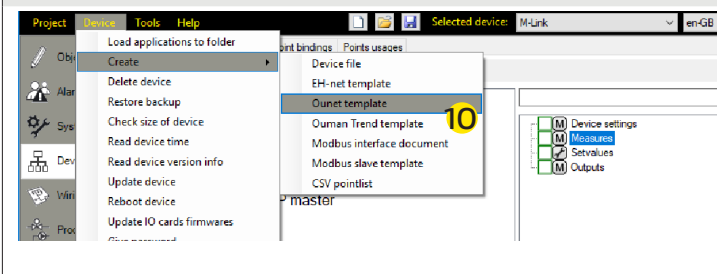

10. When the desired Modbus points have been added, select "Device" tab and then "Create" "ounet template". The device can now be brought up to Ounet.

## 7 Modbus TCP/IP communication

If you want Master devices to communicate with each other, connect the Master devices to the same subnet. This M-LINK device works as a slave device. Modbus TCP/IP server and client devices must have fixed IP.

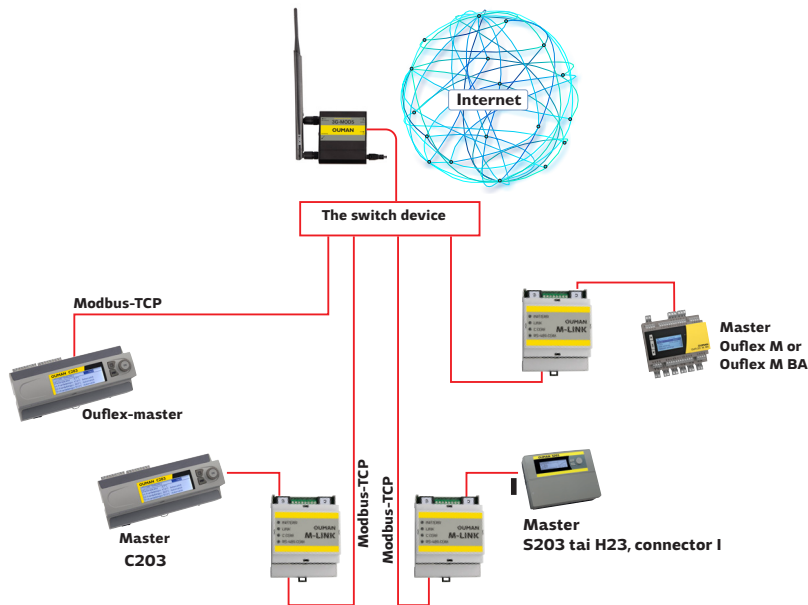

## Point transfer from device to another

If you want to do the point transfer between devices, connect devices to the bus of the M-LINK.

Add a device you want to write or read through the bus. Enter the IP address. You can read the device points of another device. Make a point transfer.

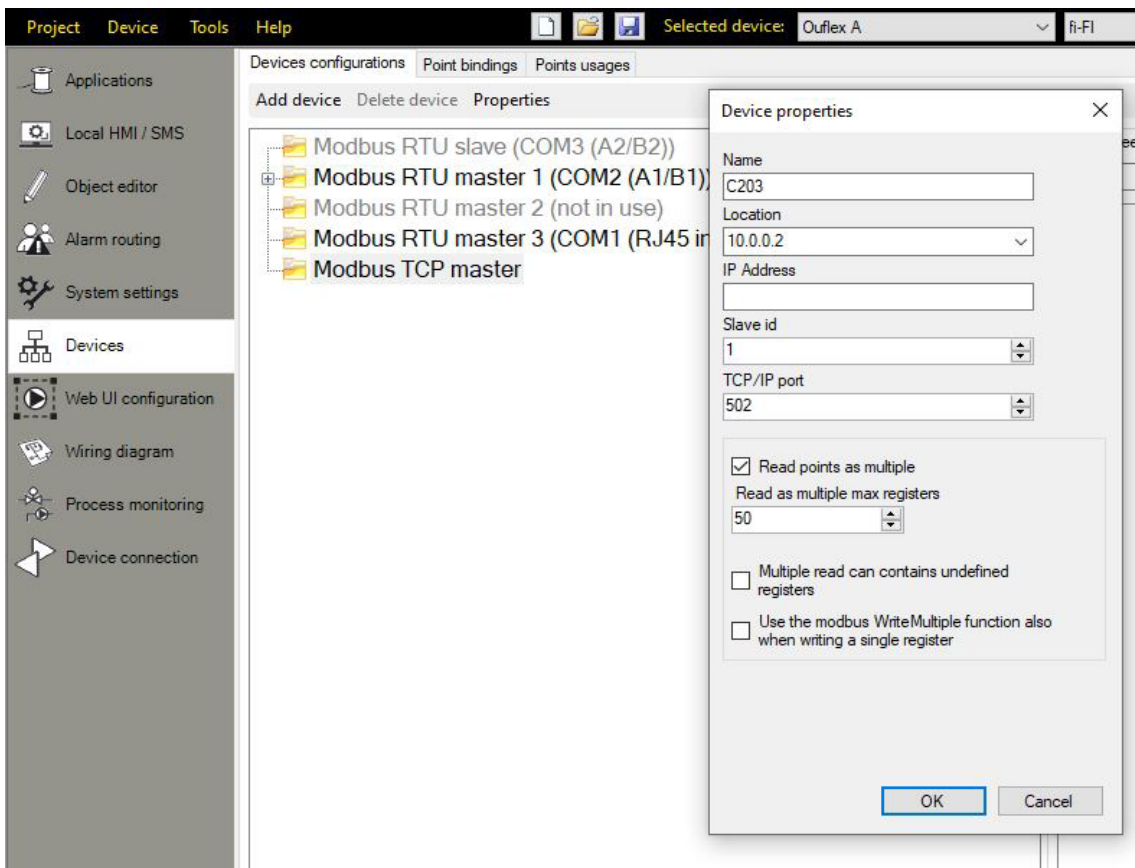

**Points are transferred as follows:** Select the device whose points are to be imported to M-LINK.

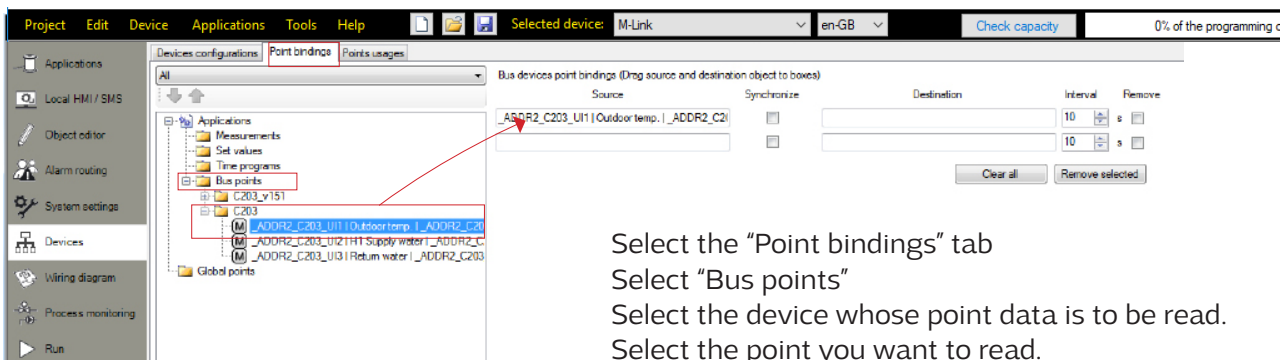
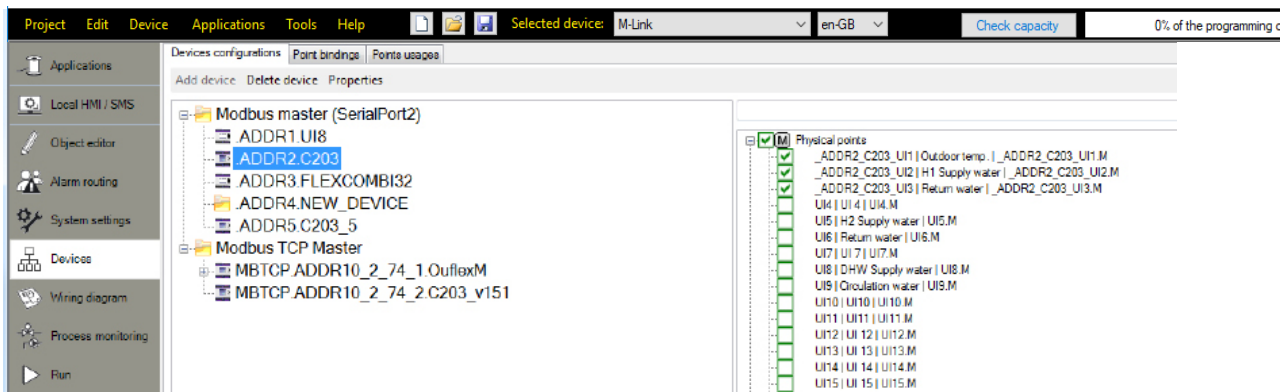

Select the "Point bindings" tab  
 Select "Bus points"  
 Select the device whose point data is to be read.  
 Select the point you want to read.  
 Drag and drop the point to the "Source" field.

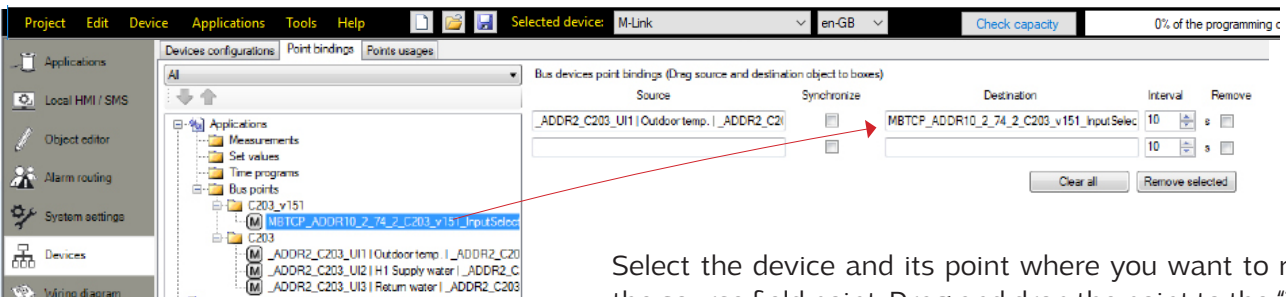

Select the device and its point where you want to read the source field point. Drag and drop the point to the "Target" field.  
 If you select "synchronize", you can both read and alter the device point (you can alter the value of the point from either device).

**Create a template for the M-LINK device and add the device to Ounet (see page 6).**

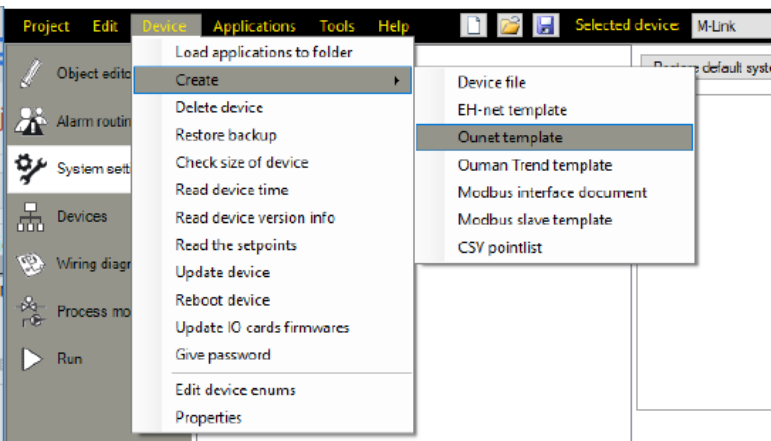

## 8 WEB UI

M-LINK includes an internal web server. You can access it using a browser. The connection works with commonly used browsers (Firefox, Chrome and Edge). As all functions have been tested using Google Chrome, we recommend that you also use Chrome. You can use the browser on a PC, smartphone, tablet or a browser touch screen purchased from Ouman.

Check the M-LINK device's host name from the label (next to the device's Ethernet port) or from the device's network settings. When you use the host name to establish a device connection, remember that, if you establish the connection remotely across the internet, the final part of the name is ouman.net. If you establish a connection through a LAN from a device, featuring the Apple, Microsoft or Linux operating system, the final part of the host name is ouman.local. The Android operating system does not recognise addresses ending in "local". This is why you need to use the IP address when logging in from Android devices to LANs.

Enter the user ID and password. The device has three user ID levels: "service", "user" or "viewer". "Service" level users have the most extensive rights. This section presents the user rights assigned to "service" level users. "User" level users can edit settings and time programs. "Viewer" level users only have viewing rights, and a user ID-specific password can be changed for these users. The device-specific password can be found from the M-LINK device's label. By default, all user IDs have the same password. Change the password.

If you log in to the device locally, DiscoveryTool or Ouflex BA Tool must be installed on your PC. If you are using Ouflex BA Tool, you can also use the SCAN function, which detects other devices connected to the same LAN and shows them in a list. You can establish a device connection by selecting a device from the SCAN list and clicking "Open connection". You can load files, settings and graphs from the tool to the device, or vice versa. The device can also be simultaneously connected to Ounet, and more than one person can be connected simultaneously to the device (tested with four people).

| Access to various functions                                | Service                  | User | Viewer |
|--|--------------------------|------|--------|
| Changing the password: Which user password can be changed? | service, user and viewer | user | viewer |
| To read charts and trends                                  | X                        | X    | X      |
| To view and acknowledge alarms                             | X                        | X    | X      |
| To modify setting values and time programs                 | X                        | X    |        |
| To edit charts   | X                        |      |        |
| To create the trend groups and edit trends                 | X                        |      |        |
| To change the control mode: automatic - manual control     | X                        |      |        |
| System settings  | X                        |      |        |
| Device management  | X                        |      |        |
| Log  | X                        |      |        |

### WEB UI "Service" username

You can see the M-LINK program version and also the application version, if given, and information about who loaded the application onto the device, when the application was loaded and what tool version was used when loading. The web user interface version is also shown.

### WEB UI "User" and "Viewer" username

## 8.1 Chart editor

You can create dynamic charts via a web browser with an editor and save the chart directly to the device, or create it with the Ouflex BA Tool and download the charts to M-LINK. The maximum number of charts is 20. Images cannot be converted to Ounet, but an existing chart can be saved as an image and used as a wallpaper in Ounet, and vice versa. You can upload an image file (eg Svg, jpeg, png) to a background image to the chart. The maximum image size is 100 kT. You can compress the image using the compression tool. You can choose to reduce the image size, reduce the image quality, resolution, and / or change the image format. The compression tool forces the jpeg and png image to be less than 100 kT in size.

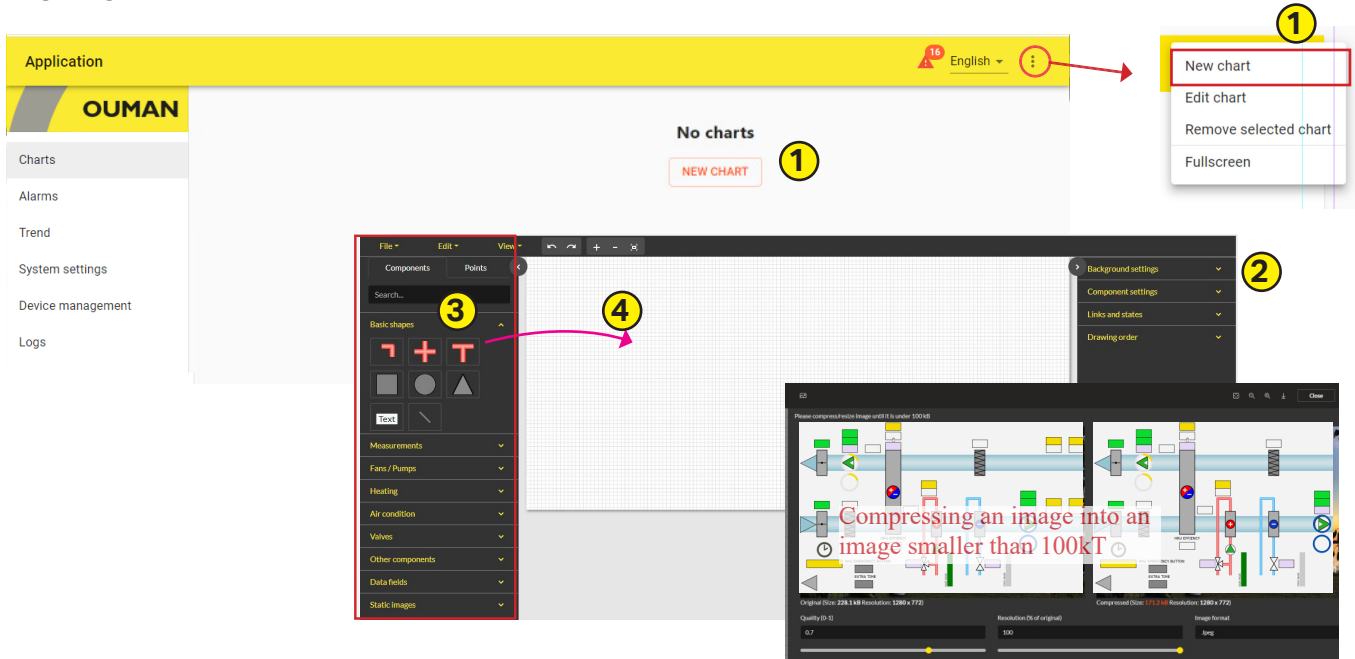

### Adding a new chart

1. Select "New chart" and enter a name for the chart (File -> Save as").
2. You can define chart background settings. You can import an image as the chart background (max. image size 100 kB) or select the background colour and grid size. The graph includes a snap function, which helps to align components with grid lines. If you do not want to use the snap function, set 0 as the grid alignment distance value.
3. You can draw the chart by using common shapes, text fields, lines, symbols and pictograms.
4. Use the mouse to drag components from the "Components" tab to the drawing surface.
5. You can define the thickness and colour of pipes. Drag pipes to the drawing surface. When you hold number key 1, you can extend the pipe from its start point. You can also add angles. When you hold number key 2, you can extend the pipe from its end point. If you hold the Shift key, you can add 45 and 90 degree angles. If you click the right mouse button, you can add or remove points between the start and end points. You can create a circuit by connecting the start point with the end point. By adding a T-pipe-component, you can connect two circuits. The rotation of the component is done in the component settings by entering the degree. With the "Snap" function, the component can be aligned with the background grid. Use the + and - keys to zoom in on the image.
6. You can change the size or colour of shape components or rotate components. You can also add a link from a component to another chart.
7. If you add a line, you can define the thickness and colour of the line in component settings. If you want to add a point onto a line, use the right mouse button. You can bend the line next to the point and change the order of the components.
8. If you add a text field, go to component settings to define the content of the text field, the font type and size, and the colour of the text.

### Basic shapes

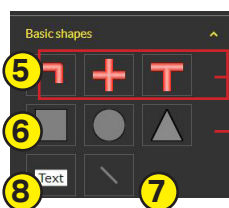

# Measurements

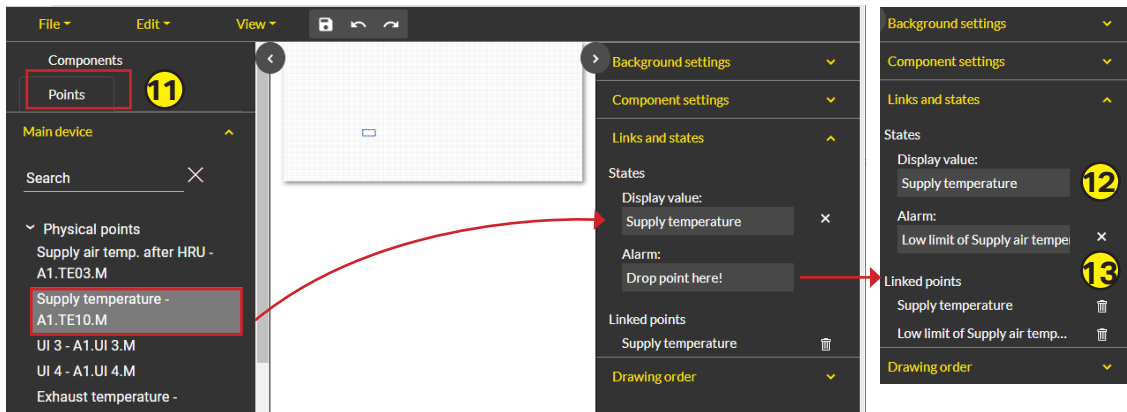
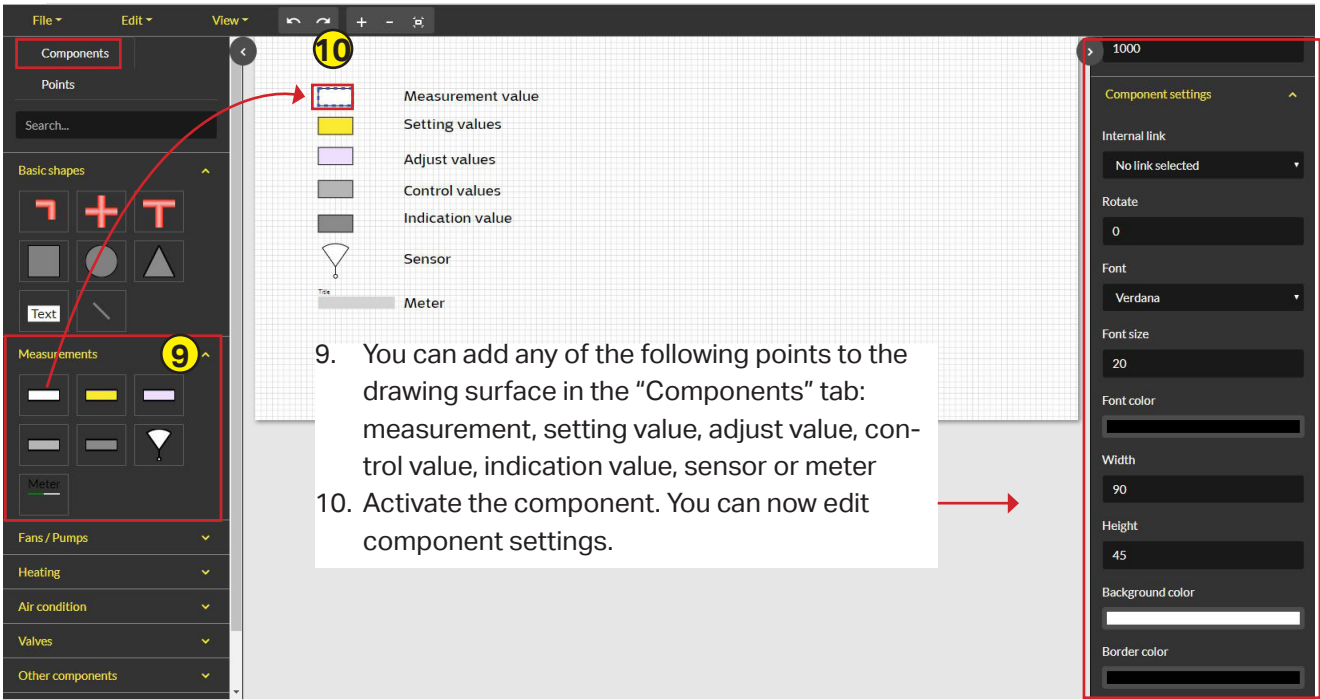

11. Activate the component and define what data is added to the specific field in the "Points" tab.
12. Drag point to the "Display value" field. If the point has an alarm, drag the point to "Alarm" field.
13. Hold down the **shift** key to select multiple individual points, or select the first and last point while holding down the **ctrl** key. Use your mouse to drag and drop the points onto the drawing surface so that the program makes a common component for the points. When you click on a box, the points appear in the "Linked points" list.

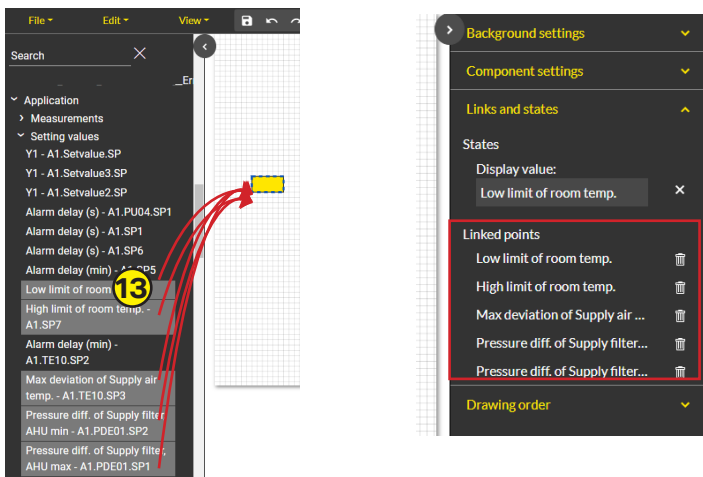

The measurement data is displayed on the "Charts" tab of your browser. Clicking on the "point" box will display list of the data linked to the point.

10 °C

**Linked points in component**

Low limit of room temp.  
Application:AHUControl.ALARMS.KTemp.ServValue0  
Value: 10 °C

High limit of room temp.  
Application:AHUControl.ALARMS.KTemp.ServValue0  
Value: 15 °C

Max deviation of Supply air temp.  
Application:AHUControl.ALARMS.SupplyTemp.ServValue0  
Value: 0.5 °C

CANCEL

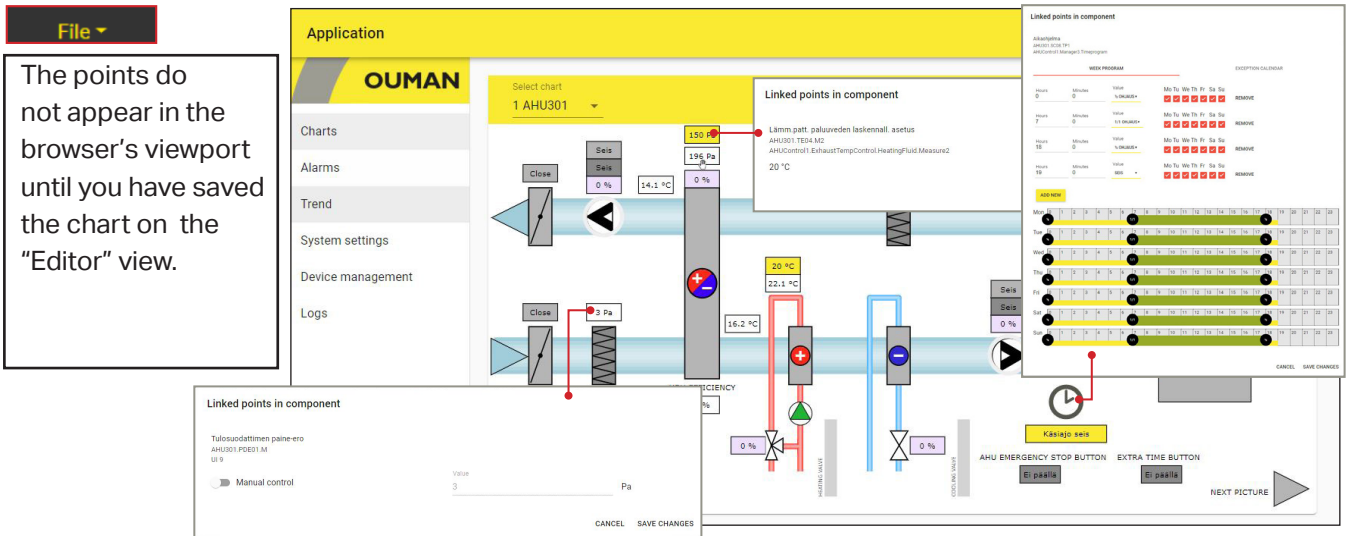
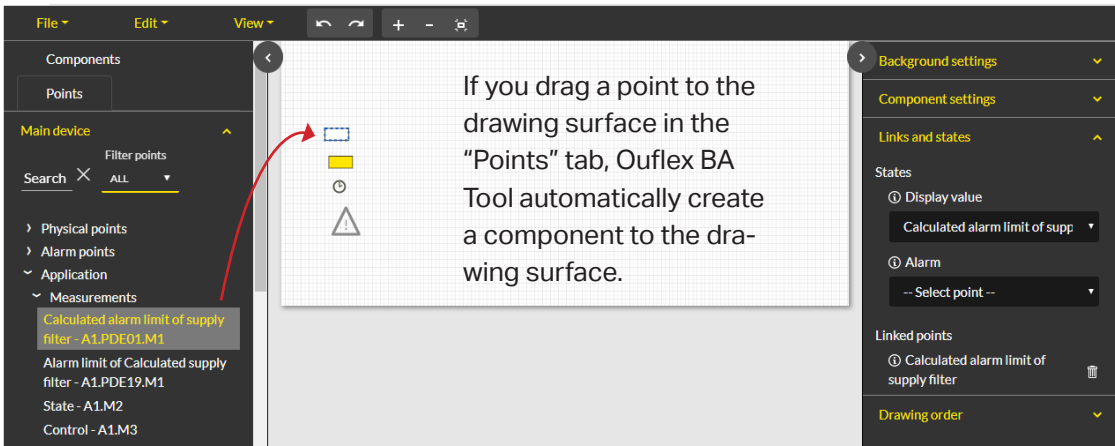

**By default, the device's WEB interface is automatically logged out after 15 minutes. If you edit the chart without saving in the editor tab for more than 15 min, then the device will log out the session and then the editing tab in the editor will not work. Do not close the Editor tab, just follow these steps:**

1. Open a new graph from the right top corner and select: "New chart".
2. You do not need to do anything for this new graph (you do not need to save it).
3. Select the "Editor" tab, in which the graph you need to save is located, and select "Save". The device will show the following message: "Chart saved".
4. Close the new graph without saving it. Continue to draw the original graph.

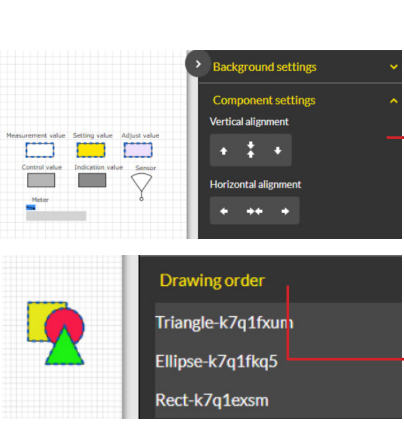

**Tips!**

- You can cut (Ctrl + X), copy (Ctrl + C), select all (Ctrl + A) or remove components (Del) by using shortcuts or by selecting "Edit".
- You can select several components by holding the Ctrl key or by holding the right mouse button while painting the area in which components are located. Then, you can process the components as a group.
- You can place a component on the X or Y axis.
- You can change the order of components by clicking the right mouse button and selecting forward, backward, etc.
- You can also change the order of components by changing the place of the components in the "Drawing order" menu.



## Basic shapes

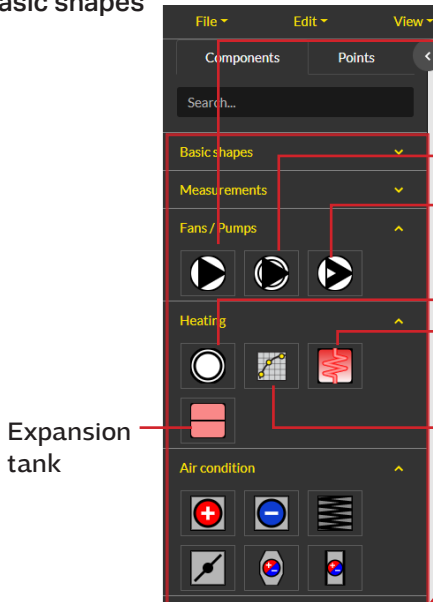

You can use ready-made drawings.

The same icon is used for different purposes in different sizes. The smaller icon symbolizes the pump and bigger symbolizes the fan.

Two-speed fan. There are indication points and alarm points for both speeds.

Continuously adjustable frequency converter

Heating curve. Change the ID. It is L1 as a default.

Heat exchanger: Select "component settings" and you can customize the size and color of the exchanger and even the size and color of the pipes.

Curve component:

In the component settings, specify the size (width and height) of the table. The curve is displayed graphically. You can name the x and y axes of the curve and determine how many points (pairs of x and y values) there are on the curve.

Drag the curve score to the fields in the "Links and states" section. In this example, the outdoor temperatures -20 and 20 are fixed, so you can pre-enter numerical values in those fields (1.Point axis and 5.Point axis). Note! +20 ° C must be entered without a sign (without a + sign).

Expansion tank

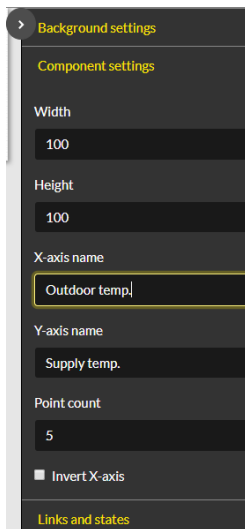

**Tip:** You can use the "search" function when searching for information to link to.

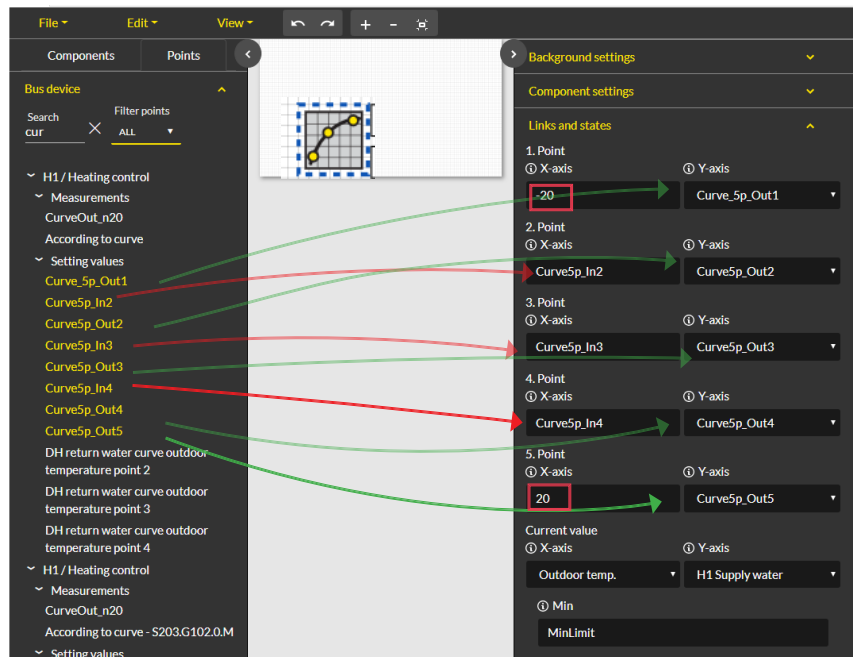

## Heating curve browser view:

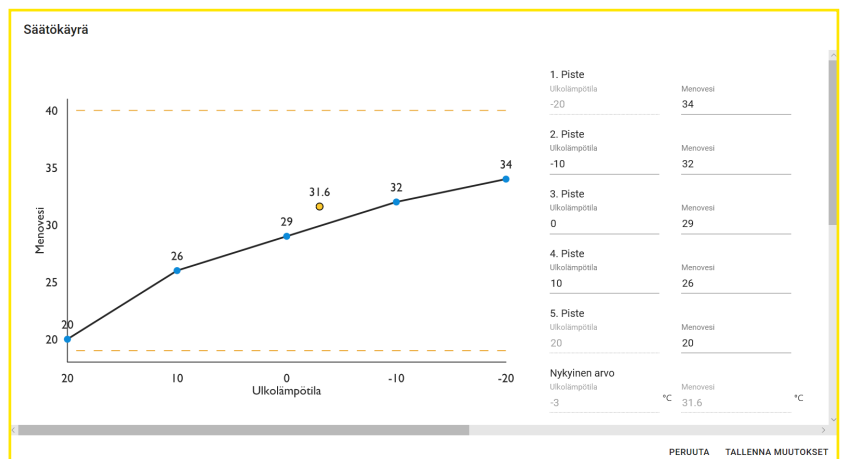

## Manual control

You can switch individual points to manual control and select the control mode. A hand icon is shown when manual control is on. The hand symbol and icon will also be shown when manual control is switched on.

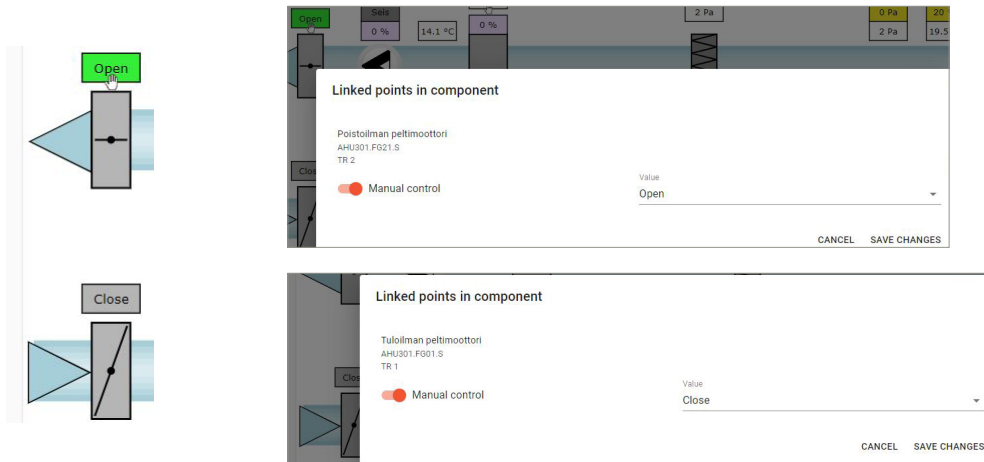

## 8.2 Alarms

The alarm icon and the number of active alarms are shown in the top right corner of the browser window. More detailed information about alarms can be found from the “Active alarms” tab.

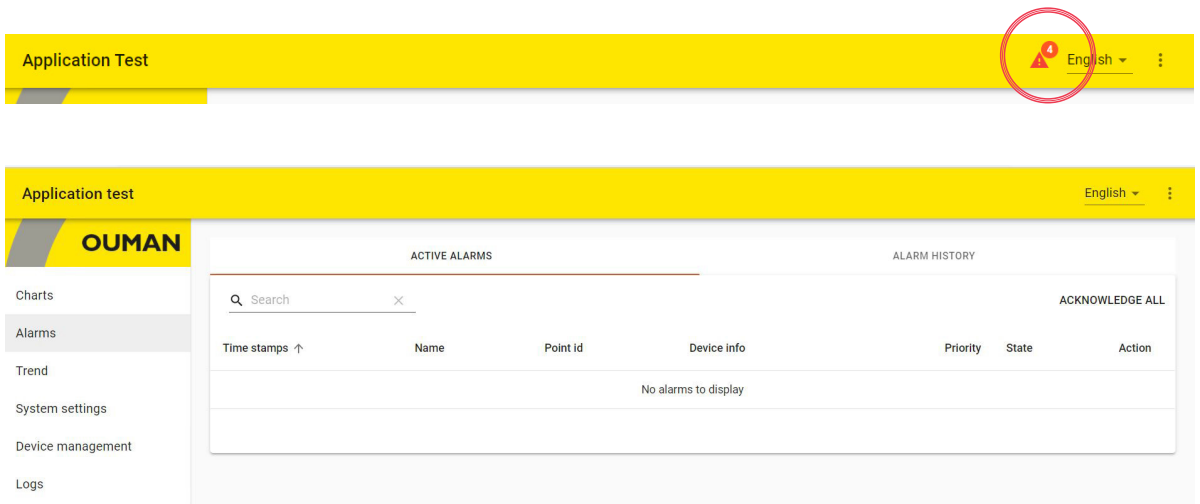

## 8.3 Trends

| Sampling interval | Trend stored on the device |
|-------------------|----------------------------|
| 10 s              | ca. 1 day                  |
| 30 s              | 3,5 day                    |
| 1 min.            | 6 day                      |
| 5 min             | 30 day                     |
| 15 min            | 100 day                    |
| 60 min            | 416 day                    |

M-LINK uses a local trend. A single trend group can consist of at most 30 trend points. The device includes 200 objects, each of which can collect 10,000 samples. The sampling interval defined determines the period, over which the device obtains trend data. For example, if the sampling interval is 10 seconds, trend data is collected over approximately one day. If the sampling interval is 60 minutes, trend data is collected over more than one year.

Select "Create trend" in the "Trends" tab.

1. Select "new group- 1". You can rename the trend group by entering a new name over the current name.
2. Drag the points you want to add to the trend group using the mouse. A single trend group can consist of at most 30 trend points. The points selected for trend data collection are highlighted in green.
3. You can edit trend data collection settings by clicking the arrow (>) in front of the point. By default, the device collects trend data using a sampling interval of 60 seconds.
4. Trend collection settings show what points have been connected to the trend group.
5. In Y axis settings, you can enter a name for the Y axis and scale the Y axis by giving the axis a minimum and maximum value. If you do not give a minimum and maximum value for the axis, it will always be scaled in accordance with default values. You can also select whether the graph is shown as a line or area and what trend points use the Y axis in question. Accept changes by clicking OK. You can create four Y axes.
6. Remember to save the settings.

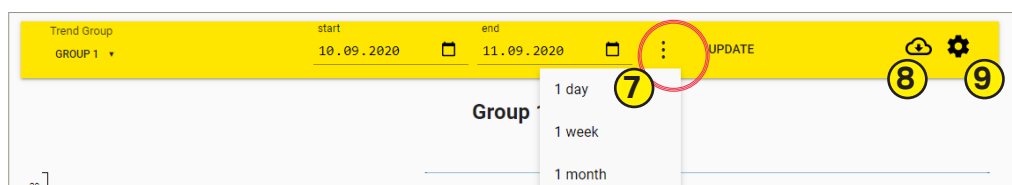
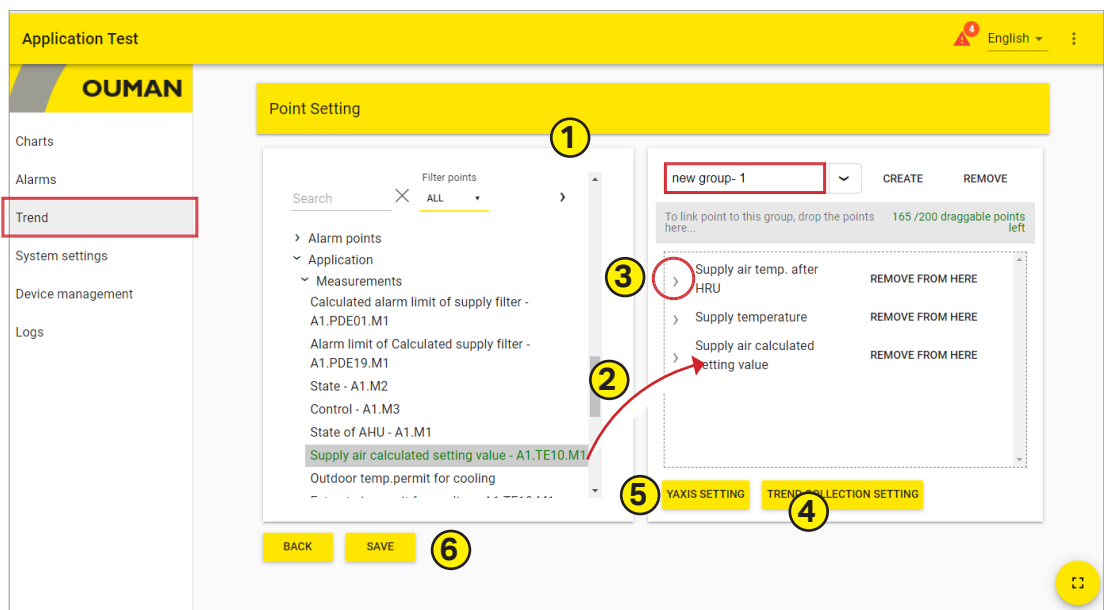

7. Define the period, over which you want to view trend data, by setting a start and end time or by selecting a day, week or month.
8. Click the icon to save trend data in a CSV file. The file can be edited in Excel.
9. Click the wheel icon to access the trend editing mode.

## 8.4 System settings

The screenshot shows the OUMAN system settings interface. The 'INFO' tab is selected, displaying various system information. The 'Device name' is set to 'M-LINK'. A callout box points to this field, stating: "The device name is shown in the top bar of the browser and in the login view." Another callout points to a refresh button at the bottom right, labeled "Update display".

## Alarm routing/ SNMP

The screenshot shows the OUMAN system settings interface with the 'ALARM ROUTING' tab selected. The 'SNMP settings' section includes the following fields:

- SNMP server IP: 10.1.1.23
- Retry delay: 1
- SNMP in use

**The SNMP function can be used for alarm transfers between Ouman devices and the cloud scada.** The SNMP function can be used for sending information on the activation, elimination and resetting of alarms to the desired server using the SNMP protocol.

| Setting               | Factory setting | Description  |
|-----------------------|-----------------|--|
| <b>SNMP server IP</b> | 10.1.1.23       | The IP address of the destination server where the message is sent. Ounet's IP address 10.1.1.23 is the default. |
| <b>Retry delay</b>    | 5 min           | If the alarm is not acknowledged from the server, the alarm message will be re-sent after the delay that is set. |
| <b>SNMP in use</b>    |                 | This selection enables/disables the entire SNMP function.  |

## Network settings

English

INFO ALARM ROUTING **NETWORK** MODBUS TCP MODBUS RTU DEVICE

DHCP In use

IP address  
10.5.74.147

Subnet mask  
255.255.255.0

Gateway  
10.5.74.1

DNS  
10.2.74.8

Hostname  
m1935500023-vyecg.ouman.local

CONFIRM

Ouman Access in use

There are two alternative ways to set the Ouflex A device IP address and network settings:

### Option A: To set the IP address using DHCP:

The DHCP function requires a DHCP service on the network that sends an IP address to M-LINK.

1. "DHCP in use" as a default .
2. Connect M-LINK and the computer to the same Ethernet network where DHCP enabled
3. You will find the device after a while using the scan function of the Ouflex BA Tool. NOTE! If BA Tool is not installed on your computer, open a browser and type in the browser's address bar the device name on the M-LINK label and log in to the device with the password on the label. The username is service.
4. Note! If you disable Ouman Access, the device will no longer be able to connect to the Internet with a browser. Ouman Access can be re-enabled from the device's network settings.

### Optin B: Setting the IP address manually:

1. "DHCP in use" as a default.
2. Connect M-LINK and the computer to the same Ethernet network where DHCP enabled.
3. You will find the device after a while using the scan function of the Ouflex BA Tool. NOTE! If BA Tool is not installed on your computer, open a browser and type in the browser's address bar the device name on the M-LINK label and log in to the device with the password on the label. The username is always service.
4. Deselect "DHCP Enabled". (If DHCP is enabled, manual changes will be overridden in (IP Address, Subnet Mask, Gateway Address, and Name Server Address (DNS))
5. When set IP-settings manually you need to ask correct settings in that LAN admimistarator.
6. Select "Confirm".

## Access service requirements

### 1. LAN is routed via Internet

The Access service operates on the Internet so the Access service is not available if the device is not connected to the Internet. The Access device examines the availability of Internet connection by sending a Ping packet to the Internet server at 3-minute intervals. The network must allow the ICMP outwards from any port and the receipt of the reply message to the same port.

### 2. The VPN protocol used by Access service outwards is not blocked

The Access service is based on the VPN connection which the Access device creates to the Access server. The network must allow the UDP outwards from any port to the port 1194 and the receipt of the reply message to this port.

### 3. Time service protocol outwards is not blocked

The Access service works only when the clock in the Access device shows the correct time. The clock is set to the correct time automatically from the network using the NTP protocol. The network must allow the UDP outwards from any port to the port 123 and the receipt of the reply message to this port.

## Modbus TCP

The screenshot shows the 'MODBUS TCP' configuration page in the M-LINK interface. The page is divided into several sections with input fields and labels:

- Gateway port 1 (TCP gateway port A1/B1 of device that is connected to M-link through C-serial):** 503
- Gateway port 2 (TCP gateway port A2/B2 of device that is connected to M-link through C-serial):** 504
- Gateway port 3 (Internal register of M-Link):** 505
- Gateway port 4 (Internal registers of device that is connected to C-Serial):** 502
- Gateway port 5 (M-link own TCP gateway port A/B. Devices that are connected to M-link own RTU-line):** 506
- Slave address for internal registers:** 1
- Maximum number of connections:** 20
- Size of request buffer:** 50
- Idle timeout before connection close:** 300
- Allowed client address:** 0.0.0.0

**Modbus TCP/IP settings are used to change the Modbus TCP server settings. The Modbus TCP/IP interface can be used for communication with Modbus/RTU slave devices connected to the device.**

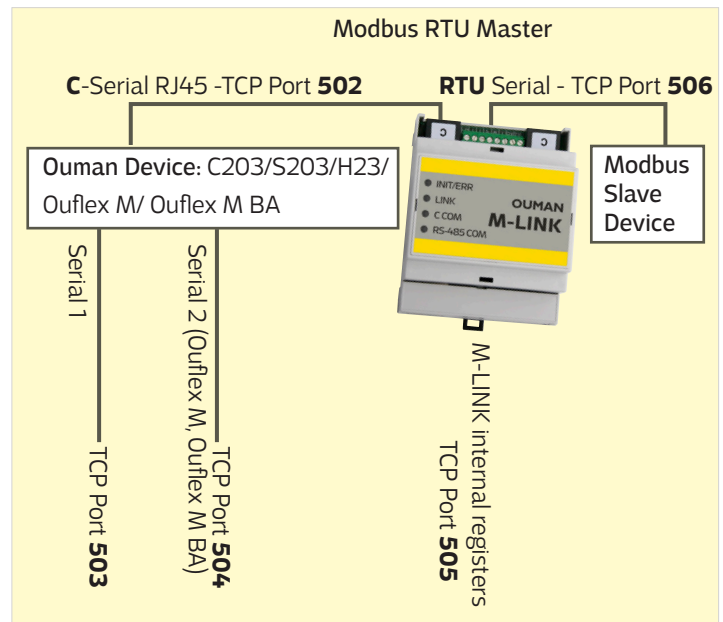

| Setting   | Factory setting | Description (see figure, page 5)  |
|---|-----------------|---|
| Gateway port 1 (TCP gateway port A1/ B1 of device that is connected to M-LINK through C-Serial) | 503             | A M-LINK-compatible device can be connected to M-LINK's C connector as a master device. The M-LINK-compatible device may have one or more RTU buses. The port setting of Modbus master 1 bus is specified here. The Port 1 setting determines the TCP/IP port serving as the gateway to the Modbus RTU bus of the M-LINK - compatible device. |
| Gateway port 2 (TCP gateway port A2/ B2 of device that is connected to M-LINK through C-Serial) | 504             | The M-LINK -compatible device may have several RTU buses. The port setting of Modbus master 2 bus is specified here. The Port 2 setting determines the TCP/IP port serving as the gateway to the Modbus RTU bus of the M-LINK- compatible device (for example, an Ouflex M device may have two RTU buses in use (A1, B1 and A2, B2))          |
| Gateway port 3 (Internal registers of M-LINK)   | 505             | M-Link's internal register details are read via this port.  |
| Port 4 (Internal registers of device that is connected to C-Serial)                             | 502             | Port 4 is reserved for the internal communication of a M-LINK-compatible device connected to M-LINK. Information from the Modbus register of a M-Link-compatible device connected to M-LINK is read/written via this port.  |
| Port 5 (M-LINK own TCP gateway port A/B. Devices that are connected to M-LINK own RTU line)     | 506             | M-LINK's own port to the RTU bus (strip terminals 5 (A) and 4 (B). If the port value is 0, port connection is not open.   |
| Slave address for internal registers  | 1               | When a M-LINK-compatible device (Ouflex M, Ouflex M BA, S203, C203, H23) is connected to M-LINK via the C connector as a slave device, the address of the device is set here.   |
| Maximum number of connections   | 20              | The server load can be changed by changing this setting. The setting determines the maximum number of allowed simultaneous connections from different IP addresses to the server.   |
| Size of requests buffer   | 50              | Buffer for TCP requests.  |
| Idle timeout before connections close   | 300             | This determines the time after which inactive connections are disconnected from the server. Value 0 means that idle timeout is not in use.  |
| Allowed client address  | 0.0.0.0         | The data security of the system can be improved by activating the allowed client address function. If the value is 0.0.0.0, connections from any IP address to the server are enabled. When you specify a certain connection address, only contacts from the specified IP address are allowed.  |
|   |                 | Refresh view.   |

## Modbus RTU settings

M-LINK has a free TCP / RTU gateway. You can read data from the measuring points of any RTU slave via Ounet. You can also add bus devices to M-LINK.

If you make changes to the serial port settings, click “” to save the changes.

| Setting   | Factory setting | Description  |
|---|-----------------|--|
| <b>Modbus master settings</b>   |                 | These settings are in use when “Master” is selected as the function of the M-Link device   |
| Modbus slave timeout  | 1000 ms         | Modbus master timeout  |
| Min delay between packets   | 100 ms          | Minimum delay between packets. If a device in the bus is unstable, bus traffic can be restored by increasing the delay between packets.  |
| Timeouts to fault state   | 5               | This setting determines the number of unanswered requests made to a slave device before changing the state of the device to fault state. A signal strength alarm is raised when the incoming delay time has passed while the fault state was active.   |
|  |                 | Read the values from the device and refresh the view.  |
| <b>Modbus RTU slave settings</b>  |                 | These settings are in use when “Slave” is selected as the function of the M-Link device  |
| Function  |                 | M-LINK can act on the bus as either a master device or a slave device. Configuring M-LINK as a slave requires programming. In this case, master points are read from another device manufacturer’s device to Ounet using M-LINK. M-LINK voi toimia väylässä joko master-laitteena tai slave-laitteena. M-LINKin konfigurointi slave-laitteeksi vaatii ohjelmointia. Tällöin luetaan toisen laitevalmistajan laitteelta master-pisteitä M-LINKin avulla Ounetiin. |
| Slave address   | 1               | .  |
| <b>Serial port (A1,B1)</b>  |                 |  |
| Baud rate   | 9600            | Speed of traffic in the bus. The devices connected to the same bus must have the same traffic speed (baud rate). The default rate is 9600 bauds, but it can be changed.  |
| Data bits   | 8               | Number of data bits in the bus. The devices connected to the same bus must have the same Data bits value.  |
| Parity  | None            | Parity of the bus. None = parity is not taken into account. Set the same parity as here for all devices in the bus.  |
| Stop bits   | 1               | Number of stop bits in the bus. The devices connected to the same serial port must have the same Stop bits setting. M-LINK only has stop bit 1.  |

## Device

The screenshot shows the 'DEVICE' configuration page in the M-LINK interface. It features a navigation bar with 'M-LINK' and 'English' (with a dropdown arrow). Below the navigation, there are tabs for 'INFO', 'ALARM ROUTING', 'NETWORK', 'MODBUS TCP', 'MODBUS RTU', and 'DEVICE'. The 'DEVICE' tab is selected. The settings include:
 

- Extensionbus in use. (Change triggers softboot)
- Synchronize controller time
- Current time: 12.07
- Current date: 30.09.2020
- Time zone: +2
- DST in use (summer and winter time)

 There are 'SET TIME' and 'SET DATE' buttons, and a yellow refresh button at the bottom right.

If an Ouman device is connected to the C connector, select "Extension bus in use". Then M-LINK's INT/ERR signal lamp will tell the status of the connection between M-Link and the M-LINK-compatible device.

DST= Daylight saving time. This selection activates the winter time / daylight saving time calendar.

| Setting                     | Description   |
|-----------------------------|---|
| <b>M-LINK</b>               |   |
| Extension bus in use        | Activating the C connector  |
| Synchronize controller time | You can choose whether the clock will be synchronised with the time server. When this selection is made, the clock of the Ouman device connected in the C connector will also be updated. |
| Time NTP sync in use        | The device reads the time from the server. The time and calendar details of the controller connected to M-LINK via a C connector will also be updated from the server.                    |
| Current time                | You can read a current time. You can also enter a current time and then click "SET TIME".   |
| Current date                | You can read a current date. Activate the date in the calendar and click "SET DATE".  |
| Time zone UTC offset        | The current time zone (Finland's time is +2:00).  |
| DST in use                  | If you select "DST in use", the device will automatically switch between winter time and daylight saving time according to the calendar.  |



## 8.5 Device management

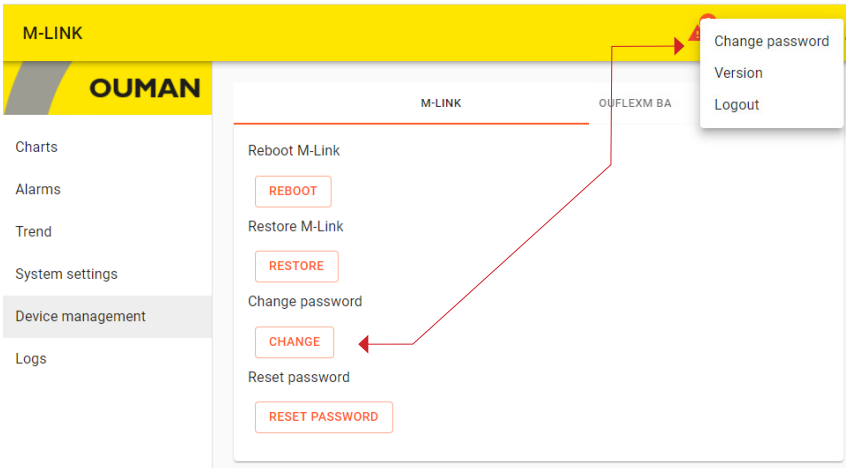

Those logging in with the **User** and **Viewer** usernames can change their password by clicking the  icon in the upper right corner. They have no visibility to the "Device Management" view.

Those logging in with the **service** username can change the password (s) either by clicking on the  icon or from the "Device Management" view. The service user can also reset the password for all users to the password on the device label.

| Setting                | Description  |
|------------------------|--|
| <b>Device (M-LINK)</b> |  |
| Reboot M-LINK          | Rebooting of the M-LINK device   |
| Restore M-LINK         | Restore factory settings.  |
| <b>Change password</b> | You can change the password of the M-LINK device. Username = service, and the password (pwd) is shown in the label at the end of the M-LINK device |
| Current password       | Enter the current password in the "Current password" field.  |
| New password           | Enter the new password in the "New password" field.  |
| Confirm password       | Re-enter the new password  |
| OK                     | The new password is activated when you click on "OK".  |
| <b>Controller</b>      |  |
| Controller update      | This is a controller connected to the C connector of the M-LINK device.  |
| Reboot controller      |  |
| Restore default        |  |

**Remote update of the controller** requires that the controller has a memory card in place and the controller platform is v. 1.2.3 or later. H23 controllers have memory card readers starting from version 2.0.0 which is why older H23 devices cannot be remotely updated via M-LINK. The devices with an Ouflex C platform can be updated starting from version 4.1.1. When performing the update, you can decide whether the controller settings are kept (Keep set values) or are factory settings restored (Clear set values). You can also cancel the update (Cancel updating).

## 8.6 Logs

When you click the “Update log”, 50 latest descriptions of bus communication errors are updated to the screen.

M-LINK English ▼

**OU MAN**

- Charts
- Alarms
- Trend
- System settings
- Device management
- Logs**

MODBUS ERROR LOG      DEVICE ERROR LOG      **DIAGNOSTIC**

Modbus buses  
ModbusMaster\_3 ▼

Search RESET SELECTED

| <input type="checkbox"/> | Device | Address <span style="font-size: 0.8em;">↑</span> | Ok messages | Error messages | CRC errors | Timeouts | Current state |
|--------------------------|--------|--|-------------|----------------|------------|----------|---------------|
| No log to display        |        |  |             |                |            |          |               |

20 rows ▼ |< < 1-0 of 0 > >|

↻

M-LINK includes open source software using the following licenses:

AFL, AGPLv3 with OpenSSL exception, BSD-2c, BSD-3c, BSD-4c, Curl license, Eclipse Public License, Flex license, GPLv2, GPLv3, LGPLv2.1, MIT, MIT with advertising clause, NTP license, OpenSSL License, pkgconf license, The "Artistic License", zlib license

The open source software in this product is distributed in the hope that it will be useful, but without any warranty, without even the implied warranty of merchantability or fitness for a particular purpose, see the applicable licenses for more details.

# M-LINK

# Technical information

|                              |   |
|------------------------------|---|
| Casing                       | PC/ABS  |
| Mounting                     | DIN rail  |
| Dimensions                   | 71 mm (4M) x 91 mm x 59 mm                          |
| Weight                       | 100 g   |
| Operating temperature        | 0 ... +50 °C.                                       |
| Storage temperature          | -20 ... +70 °C.                                     |
| Protection class             | IP 20   |
| Ethernet connection          | 10/100 Mb/s Ethernet-connection (RJ-45)             |
| Serial connections           | RS-232, RS-485 Modbus- RTU                          |
| Operating voltage            | 16-30 VDC /1.4 W or 24 VAC (-20% ... +25%) / 3.6 VA |
| Ethernet protocols           | Modbus TCP, HTTPS and SNMP                          |
| Approvals                    |   |
| - EMC Interference tolerance | EN 61000-6-1  |
| - EMC Interference emissions | EN 61000-6-3  |
| Internal Web server          | TLS 1.2   |
| Device connection to Ounet   | Own VPN tunnel                                      |
| System dependency            | Can be connected to Ounet.<br>Modbus TCP/IP support |
| Warranty                     | 2 years   |
| Manufacturer                 | Ouman Oy  |

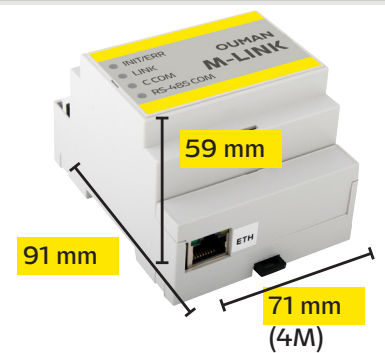

*We reserve the right to make changes to our products without a special notice.*

