

Installation instructions for Merika® dry drain

Merika no. 221

32 mm side connection

Installing 221 dry drain

The dry drain must not be installed under a shower.

Because the dry drain does not have a waterlock, it must be sewered to a floor drain with a waterlock.

Installation in a wooden floor

- The dry drain is attached by its flange to the auxiliary beams as shown in image B. **The drain must not be supported from the bottom due to potential depression of the floor. The drain shall be installed horizontally.**

- Make a $\varnothing 170$ mm hole in the floor board for the drain.
- The floor board is attached with 5 x 40 mm wood screws to the drain flange (image C).

NOTE! The screws must not touch the pipes!

- Fill the gap between the drain and the board with sealing mass.

Installation in a concrete floor

- Check before the casting work that the drain is level.
- When casting the floor, note the slope reducing effect of the water insulation flange and materials by the drain, which is especially important when using minimum slopes (1:100).

Installing the foot of the floor drain

- Use the floor drain foot (Merika no. 195), (image D) as a help when installing the drain to the correct height.
- The foot of the floor drain is cut to the correct height and the drain is attached to the foot with screws. (The screws and the screw bit belong to the installation package delivered with Merika 195).
- After this, the foot of the floor drain is attached to the floor with the screws. The drain should also be tied to the reinforcements.

Installing the build up ring to the floor drain

- The build-up ring can be cut by sawing it to the correct length and straight. The edge is bevelled.
- The build-up ring is lubricated and pushed to its place. The build up ring is attached with the supplied screws (3 pcs) to the flange of the drain.
- The screws are screwed to their places but do not tighten them (image E).
- If the build up ring is installed to the drain before casting, it shall be attached to e.g. the reinforcements.
- The clamp ring removed from the drain and the (red) casting protection suit into the build up ring.

THE CASTING PROTECTION CAN NOT BE REMOVED UNTIL THE VINYL FLOORING OR BUILD UP RING ARE INSTALLED OR WHEN MAKING THE WATER INSULATION.

Image A

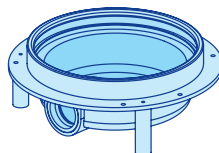

Image B

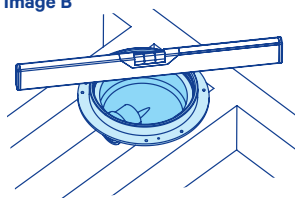

Image C

Sealing mass

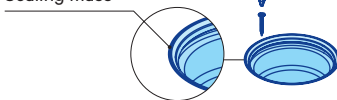

Image D

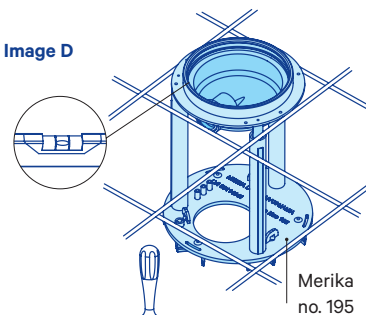
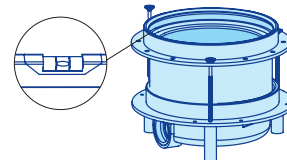

Image E



Installing vinyl flooring or water insulation flange

The clamp ring of the dry drain suits for 1,5 – 2 mm vinyl floorings.

- The drain and the sealing are cleaned carefully.
Check that the sealing is intact and in its place.
- Install the vinyl flooring to its place and cut it carefully.
- The vinyl flooring can be expanded by heating.
- The clamp ring and the cover are placed to the top of the drain and pushed evenly to the place.
- Make sure that the clamp ring is in the bottom.
- The vinyl flooring is cut along the clamp ring and the cover is put to its place. Thanks to the flexible V lip seal the vinyl flooring joint is tight without glue. Use a water insulation flange for attaching water insulation masses in tile floors (Merika no. 458).

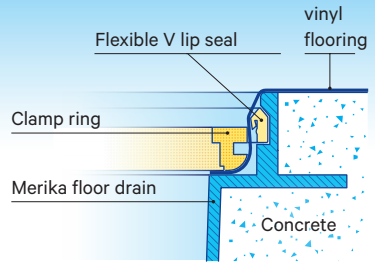

Installing the square cover to the drain or to a build up ring

- The square cover is attached by spreading the adhesive evenly on the drain or around the build up ring.
- After this, push the square cover to its place.

Cleaning and maintenance of the drain

If the drain or the pipe needs cleaning, proceed in accordance of the image F.

- Lift the cover off the drain.
- Clean the drain and pipes.
- After cleaning, the cover is aligned to the correct position and pressed to its place.

Image F

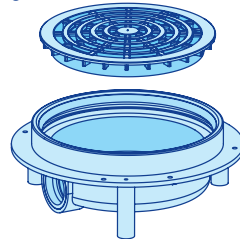

**Use Merika build-up rings
Merika no. 400, 401, 412, 413 and 414
for these floor drains.**

Merika drains and build up rings are type approved.

The approval requires that all products used belong to the Merika product series.

Supplies

- M-221** Dry drain, HVAC nr: 3310431, RSK nr: 7114596
- M-400** Build up ring, HVAC nr: 3318112
- M-401** Build up ring, HVAC nr: 3318110
- M-412** Build up ring, HVAC nr: 3318117
- M-413** Build up ring, HVAC nr: 3318111
- M-414** Build up ring, HVAC nr: 3318155
- M-457** Water insulation flange, HVAC nr: 3319671
- M-458** Water insulation flange, HVAC nr: 3319673
- M-4581** Waterproofing flange for build up ring M-400, HVAC nr: 3319674
- M-195** Floor drain foot, HVAC nr: 3311414, RSK nr: 7133841

Spare parts

- M-202_03** Floor drain lip sealing, new 160
- M-441** Merika carpet clamp ring 150 mm

In addition to this guide, the decrees 782/2017 on Humidity control performance and 1047/2017 on Water supply and sewerage equipment of properties given by the Ministry of the Environment shall be followed.



Meriser Oy

Kauppatie 2, 29900 Merikarvia
Tel. +358 (0)207 189 810
www.merika.fi, merika@meriser.fi



Quality for HVAC
Technology

