

## Installation and Operating Instruction for motion detector LUXOMAT® RC-plus next

### 1. Product information

- Motion detector with 130°, 230° or 280° detection area and anti-creep zone
- Mechanical range adjustment
- Adjustable ball head
- Dynamic adaption of the follow-up time depending on direction of movement
- Simple mounting thanks to plug-in base
- Wall, ceiling and corner mounting
- Immediate operation using factory settings
- Additional functions can be set up using the optional remote control

### 2. Operation

Motion detectors switch the light automatically depending on movement and ambient brightness.

If the ambient light is below the switch-on threshold, a movement activates the lighting.

The lighting is switched off after the follow-up time has elapsed and no movement detected.

### 3. Safety information

- ⚠ **Work on the 110-240 V mains supply may only be carried out by qualified professionals or by instructed persons under the direction and supervision of qualified skilled electrical personnel in accordance with electrotechnical regulations.**
- ⚠ **Disconnect supply before installing!**
- ⚠ **This device is not suitable for disconnection.**
- ⚠ **The total number of switchable loads is limited due to high inrush currents of electronic ballasts and LED drivers. In case of a large number of connected loads please use an external contactor.**
- ⚠ **For all connected loads, proper interference suppression is obligatory (we recommend to use our arc extinction kits).**

### 4. Mounting and aligning the detector

**Recommended mounting height: 2.5 m**

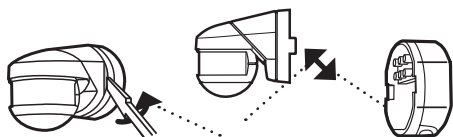

Detector can be plugged into the socket

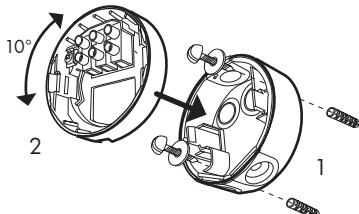

- 1) Fix the mounting socket on a solid plane using two screws (please take care with cable introduction).
- 2) Press connection socket onto mounting socket. For a better adjustment, the connection socket can be rotated through 10°.

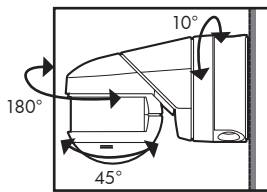

The detection range or the detection area can be modified by rotating the detector head vertically and horizontally (detector head horizontal = max. detection range)

### 5. Mounting options

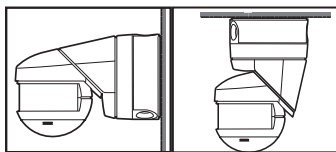

Wall mounting      Ceiling mounting

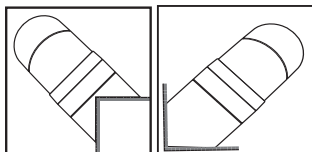

Outside / inside corner mounting using corner socket (accessory, outer corner socket included in delivery RC-plus next 280)

### 6. Mounting locations

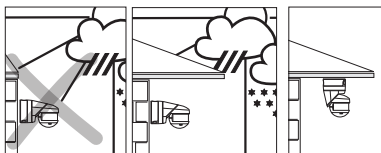

1) Mount the device at a weather-protected place.

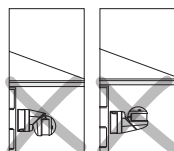

2) Follow the installation standards.

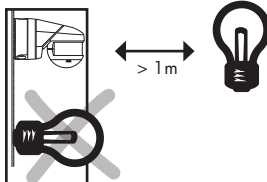

3) Minimum distance to the switched light, frontally or laterally to device: 1m

4) Do not mount a light source below the detector.

### 7. Cable introduction

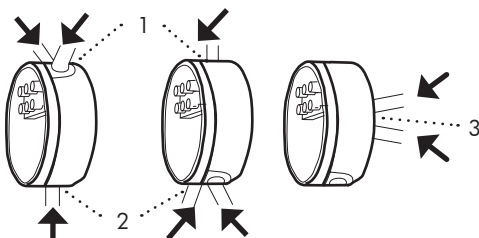

- 1) from above
- 2) from below
- 3) from wall side (please use an additional sealing, not included in delivery)
- 4) terminals (see wiring diagrams, pt. 15)

### 8. Self-test cycle

The product enters an initial 60-second self-test cycle when the supply is first connected. During this time the device does not respond to movement.

### 9. Mechanical adjusting means and potentiometers / LED arrangement

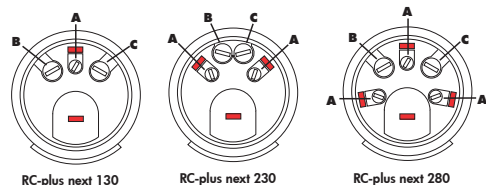

**A** Range **B** Follow-up time **C** Switch-on threshold **LED**

Remove the cap below the lens in order to access the mechanical adjusting means and potentiometers.

#### Mechanical range adjustment (A)



Depending on the version, the RC-plus next comprises a different number of detection zones (130°: 1 zone, 230°: 2 zones, 280°: 3 zones). The detection range within these zones can be adjusted individually for each zone. The number of mechanical adjusting means corresponds to the number of detection zones.

+ : approx. 20 m, - : approx. 5 m (mounting height 2.5m)

#### Test mode / Follow-up time / Pulse (B)



The test mode is for determining the detection area. Upon each detected movement the light is switched on.

The follow-up time is a time period which starts upon detected movement and which defines the duration for the connected load to stay on. The duration can be chosen between 15s and 16 min.

When PULSE is selected, a pulse of one second is sent upon detected movement, followed by a pause of nine seconds.

#### Switch-on threshold (C)

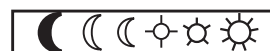

The different symbols represent different LUX values, the black moon representing night operation (light is switched on only when it is dark). The sun represents day and night operation, the light evaluation is inactive.

### 10. Factory settings



Upon delivery, the potentiometers are set to "SUN" and "TEST". This means, that the factory settings are active and the detector is ready for operation. The factory settings are as follows:

Follow-up time: 3 min.  
Switch-on threshold: 20 Lux

**11. Range at a mounting height of 2.5 m;  
Minimum mounting height 2.00 m**

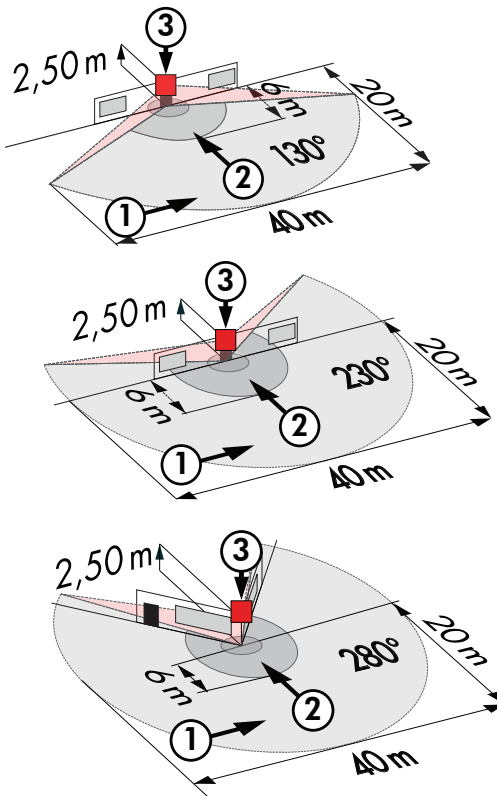

- ① Walking across
- ② Walking towards
- ③ Anti-creep zone

**12. Exclude sources of interference**

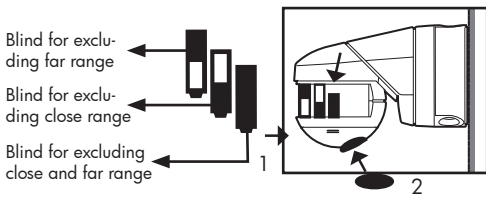

If the detection zone is too large or areas are covered that should not be monitored, use the blinds (included) to reduce or limit those areas.

- 1) Please insert blinds in front of the lens as desired (for excluding close or far range or both).
- 2) Use the sticker to cover the anti-creep zone

**13. Dynamic adaption of the follow-up time**

For improving energy savings as well as convenience, the RC-plus next offers the feature "dynamic adaption of the follow-up time".

Thanks to this function, the detector can differentiate between a movement of people or other heat sources towards the detector and a movement away from the detector. When a heat source moves towards the detector and the anti-creep sensor is the last sensor to detect movement, the follow-up time is reduced to 1/4 of the set follow-up time.

**Example: Set follow-up time = 16 minutes**

- a) heat source moving towards the detector:  
4 min reduced follow-up time
- b) heat source moving away from the detector:  
16 minutes follow-up time as set.

The function is activated by programming the detector using the remote control.

The function can be deactivated by resetting the detector using the potentiometers (see chapter "Reset the detector").

**14. Daylight measurement**

The RC-plus next constantly measures the ambient luminosity and compares the measured value with the switch-on threshold. After having noticed the state "dark" (i.e. measured value is below switch-on value for a certain duration), the lighting is switched on upon detected movement as long as movement is detected plus follow-up

time. In case the lighting is switched-on for more than 90 minutes, it will be switched off for a short time in order to allow for measuring the ambient luminosity (daylight). In case the measured value still is below the switch-on threshold, the lighting is switched on again.

**15. Wiring diagrams**

**Schematic diagrams – when connecting the detector, please respect the labelling of the terminal connections of the detector!**

**Standard operation (with optional arc extinction kit)**

When switching inductive loads (fluorescent lamps, contactors etc.) an arc extinction kit may be required.

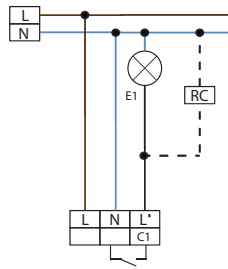

**Parallel operation**

We recommend using a maximum of five detectors in parallel operation.

When several detectors are used in parallel operation, the first detector to detect movement carries out the light measurement and switches the lighting on in case the measured value is below the switch-on value. The other detectors deactivate the light evaluation and start the follow-up time upon detected movement. Thanks to this, the lighting stays on continuously as long as one of the parallel detectors detects movement plus the follow-up time.

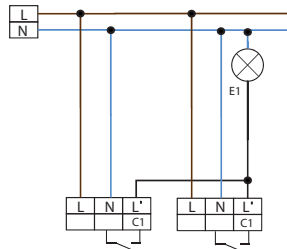

**Standard operation with external pushbutton (NC)**

When using a normally closed pushbutton in the supply line of the detector the light can be switched on or off by a short press of the pushbutton. The light stays on as long as movement is detected plus follow-up time.

Upon a long press of the pushbutton the detector loses voltage supply and the self-test cycle starts when releasing the pushbutton.

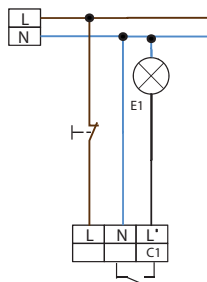

**Permanent light with external pushbutton**

Manual switching of the connected load is possible. ATTENTION: in this case, the light has to be switched off manually, too!

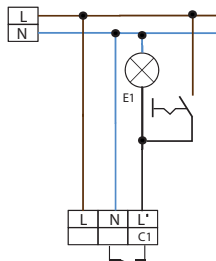

**16. Technical data**

- Voltage:** 110 - 240 VAC, 50/60 Hz
- Typ. power input:** approx. 0.5 W
- Type of contact:** Type of contact: NOC with tungsten pre-make contact,  $\mu$  contact
- Switching power:** 3000 W,  $\cos\phi = 1$   
1500 VA,  $\cos\phi = 0.5$   
max. inrush current  $I_p$  (20ms): 165 A
- Range:** approx. 20 m
- Time settings:** 15 s - 16 min, pulse
- Dynamic follow-up time:** Active when programmed via remote control
- Lux value:** approx. 2 Lux up to day-time operation (and night-time operation) - light evaluation inactive
- Factory settings:** Follow-up time 3 min.,  
Switch-on threshold approx. 20 Lux
- Detection angle:** 130° / 230° / 280°, additional 360° anti-creep zone
- Degree / class of protection:** IP54 / II
- Dimensions:** L 121 x W 71 x H 85mm
- Housing:** Polycarbonate, UV-resistant
- Mounting options:** Wall, ceiling and corner mounting (Socket for external corner mounting comes along with RC-plus next 280)
- Settings:** via potentiometers, mechanical adjusting means and remote control

The device does not fulfil the requirements of EN50131-2-2 and therefore cannot be used in professional intrusion detection systems.

**EU Declaration of Conformity**



This product respects the directives concerning

1. electromagnetic compatibility (2014/30/EU)
2. low voltage (2014/35/EU)
3. restriction of the use of certain hazardous substances in electrical and electronic equipment (2011/65/EU)

**17. Article / Part nr. / Accessory**

Type	white	brown	black	silver
RC-plus next 130	97001	97011	97021	-
RC-plus next 230	97002	97012	97022	97042
RC-plus next 280	97003	97013	97023	-

**Accessory:**

- LUXOMAT® Remote controls:**
- IR-RC (incl. wall bracket) 92000
- IR-RC-Mini 92090
- IR-Adapter for Smartphones 92726

**LUXOMAT® Outside corner sockets:**

- RC-plus next ES white: 97004
- RC-plus next ES brown: 97014
- RC-plus next ES black: 97024
- RC-plus next ES silver: 97043
- (included with LUXOMAT® RC-plus next 280)

**Various accessories:**

- LUXOMAT® Inside corner socket white 97005
- LUXOMAT® Mini-Arc extinction kit 10882
- LUXOMAT® Arc extinction kit 10880
- Wall bracket for IR-RC as replacement 92100
- Wire basket BSK white 92467

**18. LED function indicators (status LEDs, see section 23)**

LED function indicator after each mains recovery (60s self-test cycle)	
Detector not programmed	LEDs flash 1x per 1s
Detector programmed	LEDs flash 2x per 1s

LED function indicators during operation	
1 LED per detection zone	respective LED flashes upon detected movement
1 LED anti-creep zone	flashes upon detected movement
1 LED anti-creep zone	pulse function: LED flashes 1x per 1s without detection of movement

## 19. Settings with remote control (optional)

Settings with remote control overwrite the settings by the potentiometers.

- The potentiometer settings are reactivated by
  - turning the potentiometers to "test" and "sun" from any other position
  - pressing the remote control button "reset" in open state

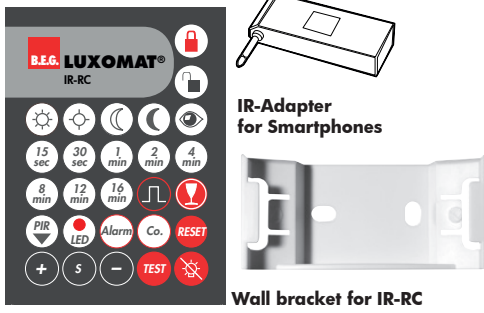

### IR-RC

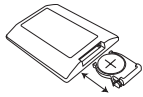

#### Check Battery:

Open battery compartment by pressing the plastic springs together and removing the battery-holder.

## 20. Functions using LUXOMAT® IR-RC

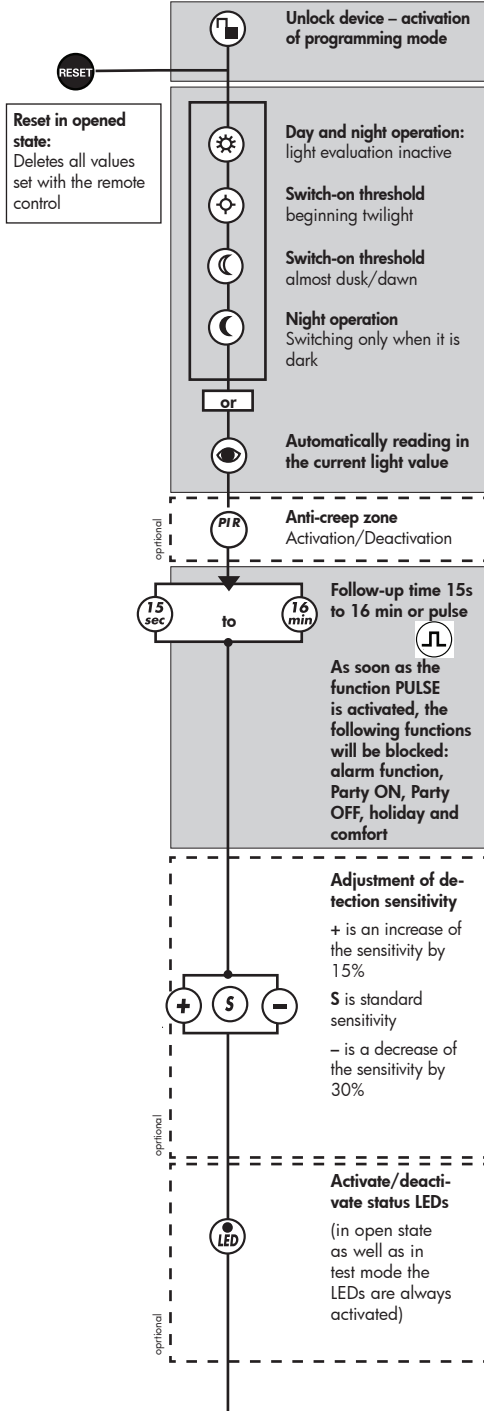

**Please note:** The infrared receiver is arranged behind the anti-creep lens, so please direct the remote control in this direction.

## 21. Function descriptions

The pressing of a button is confirmed by a short switching of the relay.

### 21a. During the self-test cycle

- The INI-ON / INI-OFF function defines if the light is on (INI-ON) or off (INI-OFF) during self-test cycle (60s after mains supply). Factory setting is INI-ON.

- INI-ON (lighting is switched on immediately)
- INI-OFF (lighting is switched off immediately)

- Activation of the Party OFF function: This function enables the lighting to be switched off for 12h when pressing the pushbutton. For safety reasons, this function is deactivated in the factory settings.

However, it is possible to activate the function by pressing:



The activation of the Party OFF function is confirmed by a fast flashing of all LEDs for 5s.

The Party OFF function can be deactivated by pressing the button



### 21b. During operation in closed state



By pressing the button the light is turned off. Upon detection of a movement, the detector switches the light on again.



In party-ON mode, the light stays on for 12h. The party-OFF mode being activated, it is possible to switch the light off for 12h using this button.



A long (>5s) press of the button restarts the device including self-test cycle. A short press of the button ends all running timers. The party function can be stopped by pressing this button.



The function "Double lock" allows to lock the detector against remote control signals. Only the function "LIGHT OFF" can be activated in this mode. The double lock function can be activated during 5s after having locked the detector (all LEDs are flashing). Activation of the double lock is confirmed by a fast blinking of all LEDs.

### 21c. During operation in open state



The potentiometers being set to TEST and SUN, the device is reset to factory settings. If not, the device is reset to potentiometer settings. The settings programmed during self-test cycle remain valid.



The function being activated, the detector works like a photoelectric switch. The light is switched on when the light value passes below the switch-on threshold (switch-on delay 1 min). The duration depends on the set follow-up time (seconds become minutes and minutes become hours). However, within 10s after having

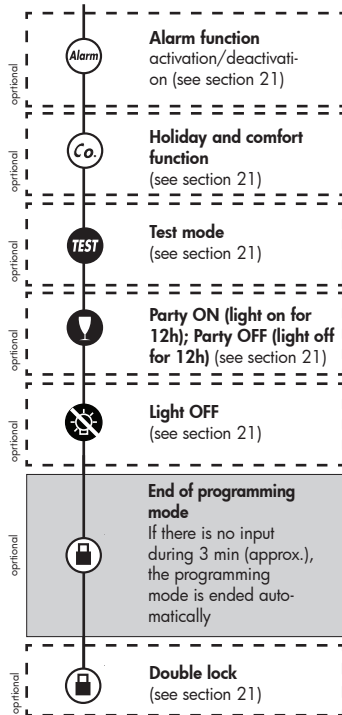

pressed the button it is possible to set a new follow-up time. After having set the new follow-up time, the device has to be locked.



The test mode is for identifying the detection area. Upon each movement, the light is switched on for a short time. After 3 min, the test mode is ended automatically.



The alarm function being activated, the light blinks upon detected movement during the first 30s of the follow-up time (this being >2min).

## 21d. Functions LUXOMAT® IR-RC-Mini

The buttons and have the same functions as explained above (in closed mode). The IR-RC mini has a further button, which is not visible and is arranged below the RESET button. This button has the same function as the LIGHT OFF button.

## 22. Resetting the detector

By turning the potentiometers to TEST and SUN during operation, the settings are deleted and the factory settings are reactivated (see section 10).

As an alternative:

- Disconnect operating voltage
- Connect operating voltage for 31s to 59s
- Disconnect operating voltage again
- Connect operating voltage again and wait for the self testing
- Open detector

With this procedure, the remote control programmed values are not deleted (before activation of the double lock). If the setting is not changed by remote control after deactivation of the double lock, the detector changes in the double locked mode again after a period of 30 minutes. This way the detector cannot be unlocked during an accidental power failure.

## 23. LED function indicators (status LEDs)

LED function indicators during self-test cycle	
Party OFF	fast flashing of all LEDs during 5s

LED function indicators during operation	
Holiday and comfort function	LED anti-creep zone 1x per 1s
Alarm function	LED anti-creep zone 2x short, 1x long
Pulse function	LED anti-creep zone 1x per 1s
End programming mode	all LEDs are flashing
Double lock activated	all LEDs are flashing fast