



onninen

Toiduainetööstuse torud ja liitmikud

2021



ROOSTEVABAD TERASTORUD

Standard: EN10217-7 TC1 / EN 10357

Materjal: EN 1.4307 Lihvitud Grit 320

EN 1.4404 Lihvitud Grit 320

Sertifikaat: EN10204/3.1

EN 1.4301, AISI 304					
ATG889	RVT TORU SMS	25,0 x 1,2 1.4307 GRIT 320	M		
ATG890	RVT TORU SMS	38,0 x 1,2 1.4307 GRIT 320	M		
ATG891	RVT TORU SMS	51,0 x 1,2 1.4307 GRIT 320	M		
ATG892	RVT TORU SMS	63,5 x 1,5 1.4307 GRIT 320	M	T	
CNI400	RVT TORU SMS	63,5 x 1,6 1.4307 GRIT 320	M		
CNI681	RVT TORU SMS	76,1 x 1,6 1.4307 GRIT 320	M		
ATG893	RVT TORU SMS	76,1 x 2,0 1.4307 GRIT 320	M	T	
ATG894	RVT TORU SMS	101,6 x 2,0 1.4307 GRIT 320	M	T	



ATG889

EN 1.4404, AISI 316L					
ATG895	HKT TORU SMS	25,0 x 1,2 1.4404 GRIT 320	M		
ATG896	HKT TORU SMS	38,0 x 1,2 1.4404 GRIT 320	M		
ATG897	HKT TORU SMS	51,0 x 1,2 1.4404 GRIT 320	M		
ATG898	HKT TORU SMS	63,5 x 1,5 1.4404 GRIT 320	M	T	
CNI399	HKT TORU SMS	63,5 x 1,6 1.4404 GRIT 320	M		
CNI680	HKT TORU SMS	76,1 x 1,6 1.4404 GRIT 320	M		
ATG899	HKT TORU SMS	76,1 x 2,0 1.4404 GRIT 320	M	T	
ATG900	HKT TORU SMS	101,6 x 2,0 1.4404 GRIT 320	M	T	



ATG895

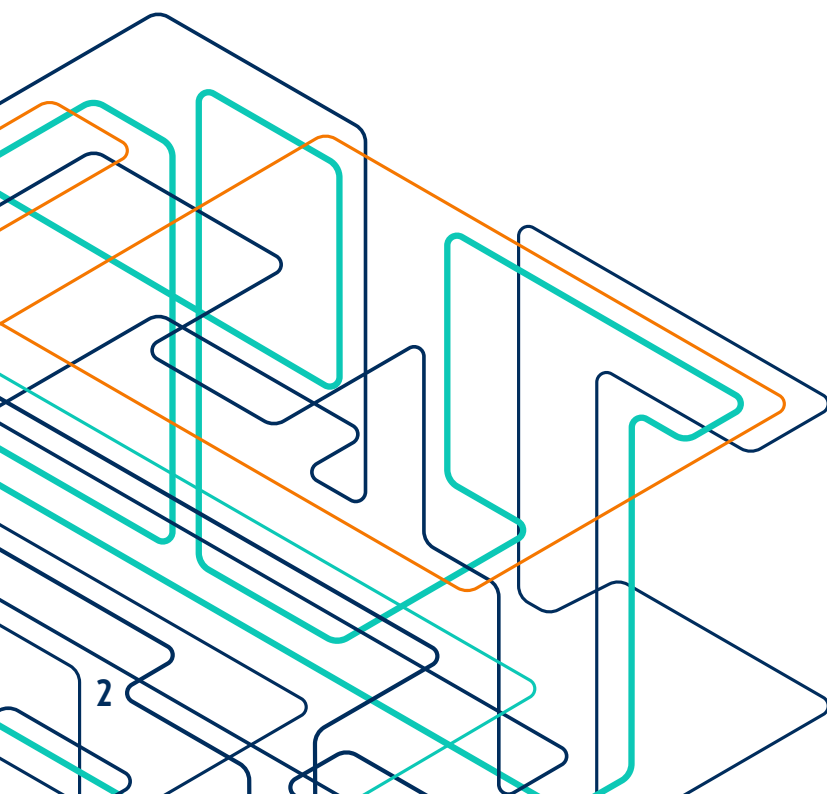

TERASPOOGEN 90° 1D SMS

Materjal: EN 1.4404, AISI 316L

EN 1.4301, AISI 304

Pinnatöötlus: Lihvitud, EN 10357

Raadius R=1 x D1

EN 1.4301, AISI 304			R	L1		
CFS095	TERASPOOGEN 90° 1D SMS	25,0 x 1,2 1.4307 LIHVITUD	25	55	TK	
CFS096	TERASPOOGEN 90° 1D SMS	38,0 x 1,2 1.4307 LIHVITUD	38	70	TK	
CFS093	TERASPOOGEN 90° 1D SMS	51,0 x 1,2 1.4307 LIHVITUD	51	82	TK	
CFS094	TERASPOOGEN 90° 1D SMS	63,5 x 1,6 1.4307 LIHVITUD	63,5	105	TK	
CFS070	TERASPOOGEN 90° 1D SMS	76,1 x 2,0 1.4307 LIHVITUD	76	110	TK	
CFS067	TERASPOOGEN 90° 1D SMS	101,6 x 2,0 1.4301 LIHVITUD	110	150	TK	T

EN 1.4404, AISI 316L			R	L1		
CFS068	TERASPOOGEN 90° 1D SMS	25,0 x 1,2 1.4404 LIHVITUD	25	55	TK	
CFS073	TERASPOOGEN 90° 1D SMS	38,0 x 1,2 1.4404 LIHVITUD	38	70	TK	
CFS074	TERASPOOGEN 90° 1D SMS	51,0 x 1,2 1.4404 LIHVITUD	51	82	TK	
CFS071	TERASPOOGEN 90° 1D SMS	63,5 x 1,6 1.4404 LIHVITUD	63,5	105	TK	
CFS077	TERASPOOGEN 90° 1D SMS	76,1 x 2,0 1.4404 LIHVITUD	76	110	TK	
CFS078	TERASPOOGEN 90° 1D SMS	101,6 x 2,0 1.4404 LIHVITUD	110	150	TK	T

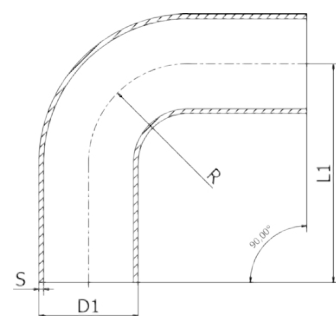

CFS095

TERASPOOGEN 45° 1D SMS

Materjal: EN 1.4404, AISI 316L

EN 1.4301, AISI 304

Pinnatöötlus: Lihvitud, EN 10357

Raadius R=1 x D1

EN 1.4301, AISI 304			R	L1		
CNI372	TERASPOOGEN 45° 1D SMS	25,0 x 1,2 1.4307 LIHVITUD	25	77	TK	
CNI373	TERASPOOGEN 45° 1D SMS	38,0 x 1,2 1.4307 LIHVITUD	38	97	TK	
CNI377	TERASPOOGEN 45° 1D SMS	51,0 x 1,2 1.4307 LIHVITUD	51	108	TK	
CNI375	TERASPOOGEN 45° 1D SMS	63,5 x 1,6 1.4307 LIHVITUD	63,5	138	TK	
CNI379	TERASPOOGEN 45° 1D SMS	76,1 x 2,0 1.4307 LIHVITUD	76	140	TK	

EN 1.4404, AISI 316L			R	L1		
CFS075	TERASPOOGEN 45° 1D SMS	25,0 x 1,2 1.4404 LIHVITUD	25	77	TK	
CFS076	TERASPOOGEN 45° 1D SMS	38,0 x 1,2 1.4404 LIHVITUD	38	97	TK	
CFS081	TERASPOOGEN 45° 1D SMS	51,0 x 1,2 1.4404 LIHVITUD	51	108	TK	
CFS082	TERASPOOGEN 45° 1D SMS	63,5 x 1,6 1.4404 LIHVITUD	63,5	138	TK	
CFS079	TERASPOOGEN 45° 1D SMS	76,1 x 1,6 1.4404 LIHVITUD	76	140	TK	
CNI380	TERASPOOGEN 45° 1D SMS	76,1 x 2,0 1.4404 LIHVITUD	76	140	TK	
CFS080	TERASPOOGEN 45° 1D SMS	101,6 x 2,0 1.4404 LIHVITUD	150	186	TK	T

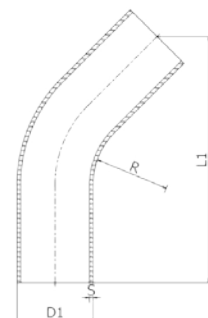

CFS075

KOLMIK LÜHIKE SMS

Matejal: EN 1.4404, AISI 316L

EN 1.4301, AISI 304

Pinnatöötlus: Lihvitud, EN 10357

Lühike, tõmmatud

EN 1.4301, AISI 304			L0	L2		
CFS336	KOLMIK LÜHIKE SMS	25,0 x 1,2 1.4307 LIHVITUD	55	14	TK	
CFS200	KOLMIK LÜHIKE SMS	38,0 x 1,2 1.4307 LIHVITUD	70	22	TK	
CFS201	KOLMIK LÜHIKE SMS	51,0 x 1,2 1.4307 LIHVITUD	82	29	TK	
CFS198	KOLMIK LÜHIKE SMS	63,5 x 1,6 1.4307 LIHVITUD	105	35	TK	
CFS199	KOLMIK LÜHIKE SMS	76,1 x 1,6 1.4301 LIHVITUD	110	41	TK	T
CNI378	KOLMIK LÜHIKE SMS	76,1 x 2,0 1.4307 LIHVITUD	110	41	TK	
CFS204	KOLMIK LÜHIKE SMS	101,6 x 2,0 1.4301 LIHVITUD	150	55	TK	T

EN 1.4404, AISI 316L			L	D		
CFS205	KOLMIK LÜHIKE SMS	25,0 x 1,2 1.4404 LIHVITUD	55	14	TK	
CFS202	KOLMIK LÜHIKE SMS	38,0 x 1,2 1.4404 LIHVITUD	70	22	TK	
CFS203	KOLMIK LÜHIKE SMS	51,0 x 1,2 1.4404 LIHVITUD	82	29	TK	
CFS208	KOLMIK LÜHIKE SMS	63,5 x 1,6 1.4404 LIHVITUD	105	35	TK	
CFS209	KOLMIK LÜHIKE SMS	76,1 x 1,6 1.4404 LIHVITUD	110	41	TK	T
CNI383	KOLMIK LÜHIKE SMS	76,1 x 2,0 1.4404 LIHVITUD	110	41	TK	
CFS206	KOLMIK LÜHIKE SMS	101,6 x 2,0 1.4404 LIHVITUD	150	55	TK	T

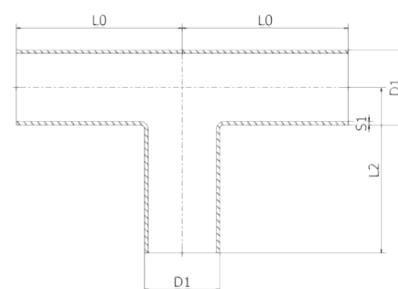

CFS336

AHENEV KOLMIK LÜHIKE SMS

Materjal: EN 1.4404, AISI 316L

Pinnatöötlus: Lihvitud, EN 10357

Lühike, tõmmatud



EN 1.4404, AISI 316L			L0	L1		
CFS207	AHENEV KOLMIK LÜHIKE SMS	38,0x25,0x1,2 1.4404 LIHVITUD	70	22	TK	T
CFS213	AHENEV KOLMIK LÜHIKE SMS	51,0x38,0x1,2 1.4404 LIHVITUD	82	29	TK	T
CFS211	AHENEV KOLMIK LÜHIKE SMS	63,5x38,0x1,6x1,2 1.4404 LIHVITUD	105	35	TK	T
CFS216	AHENEV KOLMIK LÜHIKE SMS	63,5x51,0x1,6x1,2 1.4404 LIHVITUD	105	35	TK	T
CFS217	AHENEV KOLMIK LÜHIKE SMS	76,1x25,0x1,6x1,2 1.4404 LIHVITUD	110	41	TK	T
CFS220	AHENEV KOLMIK LÜHIKE SMS	76,1x63,5x1,6 1.4404 LIHVITUD	110	41	TK	T

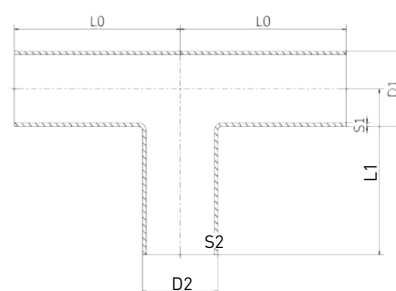

CFS207



AHENEVAD SIIRDMIKUD

AHENEV SIIRDMIK, KONTSESTRILINE SMS

Materjal: EN 1.4404, AISI 316L

Pinnatöötlus: Lihvitud, EN 10357

EN 1.4404, AISI 316L			L1		
CFS240	AHENEV SIIRDMIK, KONS. SMS	38,0 x 25,0 x 1,2 1.4404 LIHVITUD	39	TK	
CFS242	AHENEV SIIRDMIK, KONS. SMS	51,0 x 25,0 x 1,2 1.4404 LIHVITUD	77,4	TK	
CFS236	AHENEV SIIRDMIK, KONS. SMS	51,0 x 38,0 x 1,2 1.4404 LIHVITUD	40,5	TK	
CFS247	AHENEV SIIRDMIK, KONS. SMS	63,5 x 51,0 x 1,6 1.4404 LIHVITUD	37,4	TK	T
CNI381	AHENEV SIIRDMIK, KONS. SMS	63,5 x 51,0 x 1,2 1.4404 LIHVITUD	37,4	TK	
CNI382	AHENEV SIIRDMIK, KONS. SMS	76,1 x 51,0 x 1,6 1.4404 LIHVITUD	72	TK	
CFS244	AHENEV SIIRDMIK, KONS. SMS	76,1 x 51,0 x 2,0 1.4404 LIHVITUD	72	TK	T
CNI374	AHENEV SIIRDMIK, KONS. SMS	76,1 x 63,5 x 1,6 1.4404 LIHVITUD	35,7	TK	
CFS246	AHENEV SIIRDMIK, KONS. SMS	76,1 x 63,5 x 2,0 1.4404 LIHVITUD	35,7	TK	T
CFS254	AHENEV SIIRDMIK, KONS. SMS	101,6 x 63,5 x 2,0 1.4404 LIHVITUD	105,2	TK	T
CFS251	AHENEV SIIRDMIK, KONS. SMS	101,6 x 76,1 x 2,0 1.4404 LIHVITUD	77,6	TK	T

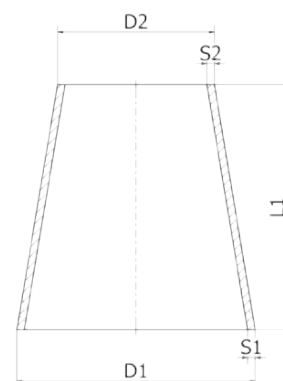

CFS240

AHENEV SIIRDMIK, EKSTSESTRILINE SMS

Materjal: EN 1.4404, AISI 316L

Pinnatöötlus: Lihvitud, EN 10357

EN 1.4404, AISI 316L			A		
CFS252	AHENEV SIIRDMIK, EKS. SMS	38,0 x 25,0 x 1,2 1.4404 LIHVITUD	37,9	TK	
CFS257	AHENEV SIIRDMIK, EKS. SMS	51,0 x 25,0 x 1,2 1.4404 LIHVITUD	75,5	TK	
CFS258	AHENEV SIIRDMIK, EKS. SMS	51,0 x 38,0 x 1,2 1.4404 LIHVITUD	39,6	TK	
CFS256	AHENEV SIIRDMIK, EKS. SMS	63,5 x 51,0 x 1,2 1.4404 LIHVITUD	36,3	TK	
CNI371	AHENEV SIIRDMIK, EKS. SMS	76,1 x 51,0 x 1,6 1.4404 LIHVITUD	70,2	TK	
CFS262	AHENEV SIIRDMIK, EKS. SMS	76,1 x 51,0 x 2,0 1.4404 LIHVITUD	70,2	TK	T
CNI376	AHENEV SIIRDMIK, EKS. SMS	76,1 x 63,5 x 1,6 1.4404 LIHVITUD	35,8	TK	
CFS259	AHENEV SIIRDMIK, EKS. SMS	76,1 x 63,5 x 2,0 1.4404 LIHVITUD	35,8	TK	T

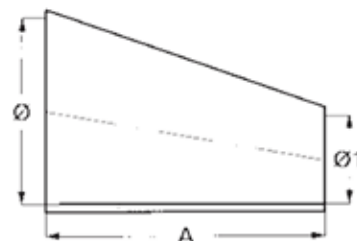

CFS252

SMS LIITMIKUD

SMS ÜHENDUSE MUTTER

Materjal: EN 1.4307, AISI 304L

			K	
AL0498	SMS ÜHENDUSE MUTTER	25 AISI304	20	TK
AL0499	SMS ÜHENDUSE MUTTER	38 AISI304	25	TK
AL0500	SMS ÜHENDUSE MUTTER	51 AISI304	26	TK
AL0501	SMS ÜHENDUSE MUTTER	63,5 AISI304	30	TK
AL0502	SMS ÜHENDUSE MUTTER	76,0 AISI304	32	TK



AL0498

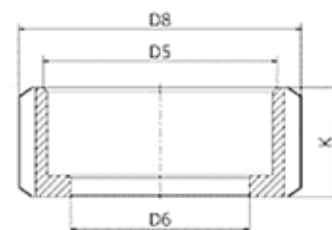
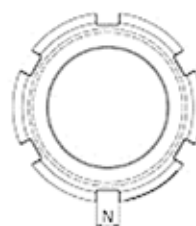

SMS ÜHENDUSE KEERE, KEEVITATAV

Materjal: EN 1.4404, AISI 316L
EN 1.4301, AISI 304

EN 1.4301, AISI 304			C	D5	
AL0503	SMS ÜHENDUSE KEERE, KEEVITATAV	25,0 x 1,5 AISI304	15	40	TK
AL0504	SMS ÜHENDUSE KEERE, KEEVITATAV	38,0 x 1,5 AISI304	20	60	TK
AL0505	SMS ÜHENDUSE KEERE, KEEVITATAV	51,0 x 1,5 AISI304	20	70	TK
AL0506	SMS ÜHENDUSE KEERE, KEEVITATAV	63,5 x 1,5 AISI304	24	85	TK
AL0507	SMS ÜHENDUSE KEERE, KEEVITATAV	76,0 x 1,6 AISI304	24	98	TK



AL0503

EN 1.4404, AISI 316L			C	D5	
AT0677	SMS ÜHENDUSE KEERE, KEEVITATAV	25,0 x 1,5 AISI316	15	40x1/6	TK
AT0678	SMS ÜHENDUSE KEERE, KEEVITATAV	38,0 x 1,5 AISI316	20	60x1/6	TK
AT0679	SMS ÜHENDUSE KEERE, KEEVITATAV	51,0 x 1,5 AISI316	20	70x1/6	TK
AT0680	SMS ÜHENDUSE KEERE, KEEVITATAV	63,5 x 1,5 AISI316	24	85x1/6	TK
AT0681	SMS ÜHENDUSE KEERE, KEEVITATAV	76,0 x 1,6 AISI316	24	98x1/6	TK

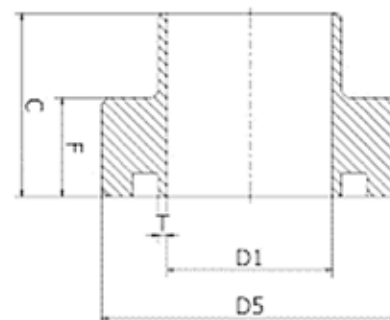

SMS LIITMIKUD

SMS ÜHENDUSE RÕNGAS

Materjal: EN 1.4404, AISI 316L
EN 1.4301, AISI 304

EN 1.4301, AISI 304			H	D5	
AL0508	SMS ÜHENDUSE RÕNGAS	25,0 x 1,5 AISI304	8	35,5	TK
AL0509	SMS ÜHENDUSE RÕNGAS	38,0 x 1,5 AISI304	9	55	TK
AL0510	SMS ÜHENDUSE RÕNGAS	51,0 x 1,5 AISI304	9	65	TK
AL0511	SMS ÜHENDUSE RÕNGAS	63,5 x 1,5 AISI304	9	80	TK
AL0512	SMS ÜHENDUSE RÕNGAS	76,0 x 1,6 AISI304	10	93	TK

EN 1.4404, AISI 316L			H	D5	
AT0682	SMS ÜHENDUSE RÕNGAS	25,0 x 1,5 AISI316	8	35,5	TK
AT0683	SMS ÜHENDUSE RÕNGAS	38,0 x 1,5 AISI316	9	55	TK
AT0684	SMS ÜHENDUSE RÕNGAS	51,0 x 1,5 AISI316	9	65	TK
AT0685	SMS ÜHENDUSE RÕNGAS	63,5 x 1,5 AISI316	9	80	TK
AT0686	SMS ÜHENDUSE RÕNGAS	76,0 x 1,6 AISI316	10	93	TK

SMS OTSAKORK

EN 1.4301, AISI 304			B	C		
AT0635	SMS OTSAKORK	25 AISI304	19	40x1/6	TK	T
AT0636	SMS OTSAKORK	38 AISI304	23	60x1/6	TK	
AT0637	SMS OTSAKORK	51 AISI304	24	70x1/6	TK	
AT0638	SMS OTSAKORK	63,5 AISI304	28	85x1/6	TK	
AT0639	SMS OTSAKORK	76,0 AISI304	30	98x1/6	TK	

SMS ÜHENDUSE TIHEND

Materjal: EPDM

AL0513	SMS ÜHENDUSE TIHEND	25 EPDM	TK
AL0514	SMS ÜHENDUSE TIHEND	38 EPDM	TK
AL0515	SMS ÜHENDUSE TIHEND	51 EPDM	TK
AL0516	SMS ÜHENDUSE TIHEND	63,5 EPDM	TK
AL0517	SMS ÜHENDUSE TIHEND	76,0 EPDM	TK



AL0508

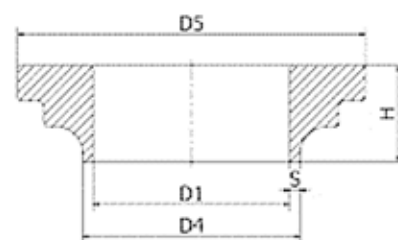

AT0635

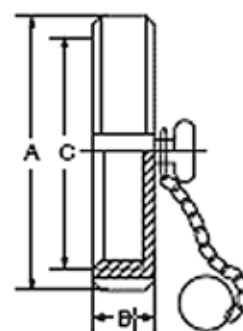

AL0513

CLAMP - ÜHENDUSED

CLAMP KLAMBER

Material: EN 1.4301, AISI 304

ALO464	CLAMP KLAMBER DIN32676	DN25 - 40 / 1" - 1 1/2" AISI304	TK
ALO465	CLAMP KLAMBER DIN32676	DN50 / 2" AISI304	TK
CEQ333	CLAMP KLAMBER DIN32676	DN 2 1/2" AISI304	TK
ALO466	CLAMP KLAMBER DIN32676	DN65 / 3" AISI304	TK
ALO467	CLAMP KLAMBER DIN32676	DN80 AISI304	TK



ALO464

CLAMP RÕNGAS SMS

Material: EN 1.4404, AISI 316L

Pinnatöötlus: Lihvitud, 0,8 µm EN 10357

			L	K	
AT0687	CLAMP RÕNGAS SMS	1"/25 AISI316	21,5	50,5	TK
AT0688	CLAMP RÕNGAS SMS	1 1/2"/38 AISI316	21,5	50,5	TK
AT0689	CLAMP RÕNGAS SMS	2"/51 AISI316	21,5	64	TK
AT0690	CLAMP RÕNGAS SMS	2 1/2"/63,5 AISI316	21,5	77,5	TK
AT0691	CLAMP RÕNGAS SMS	3"/76 AISI316	21,5	91	TK



AT0687

CLAMP TIHEND SMS

Material: EPDM

AT0692	CLAMP TIHEND SMS	1"/25mm EPDM	TK
AT0693	CLAMP TIHEND SMS	1 1/2"/38mm EPDM	TK
AT0694	CLAMP TIHEND SMS	2"/51mm EPDM	TK
AT0695	CLAMP TIHEND SMS	2 1/2"/63,5mm EPDM	TK
AT0696	CLAMP TIHEND SMS	3"/76,1mm EPDM	TK



AT0692

SMS TORUKANDURID

			A	
AL0518	TORUKANDUR SMS	25 AISI304	78	TK
AL0519	TORUKANDUR SMS	38 AISI304	91	TK
AL0520	TORUKANDUR SMS	51 AISI304	104	TK
AL0521	TORUKANDUR SMS	63,5 AISI304	116	TK
AL0522	TORUKANDUR SMS	76,0 AISI304	129	TK

			A	
CFS119	TORUKANDUR LÜHIKESE JALAGA SMS	38 90mm AISI304	91	TK
CFS120	TORUKANDUR LÜHIKESE JALAGA SMS	51 90mm AISI304	104	TK
CFS117	TORUKANDUR LÜHIKESE JALAGA SMS	63,5 90mm AISI304	116	TK
CFS118	TORUKANDUR LÜHIKESE JALAGA SMS	76,1 90mm AISI304	129	TK
CFS121	TORUKANDUR LÜHIKESE JALAGA SMS	101,6 90mm AISI304	155	TK

			A		
CFS224	TORUKANDUR PIKA JALAGA SMS	38 150mm AISI304	91	TK	T
CFS232	TORUKANDUR PIKA JALAGA SMS	51 150mm AISI304	104	TK	T
CFS234	TORUKANDUR PIKA JALAGA SMS	63,5 150mm AISI304	116	TK	T
CFS228	TORUKANDUR PIKA JALAGA SMS	76,1 150mm AISI304	129	TK	T
CFS230	TORUKANDUR PIKA JALAGA SMS	101,6 150mm AISI304	155	TK	T



AL0518

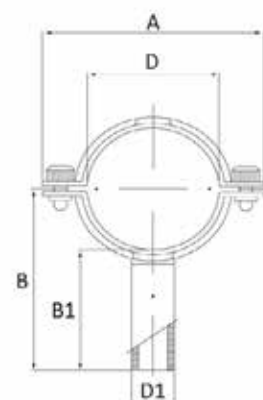

CFS119



CFS224

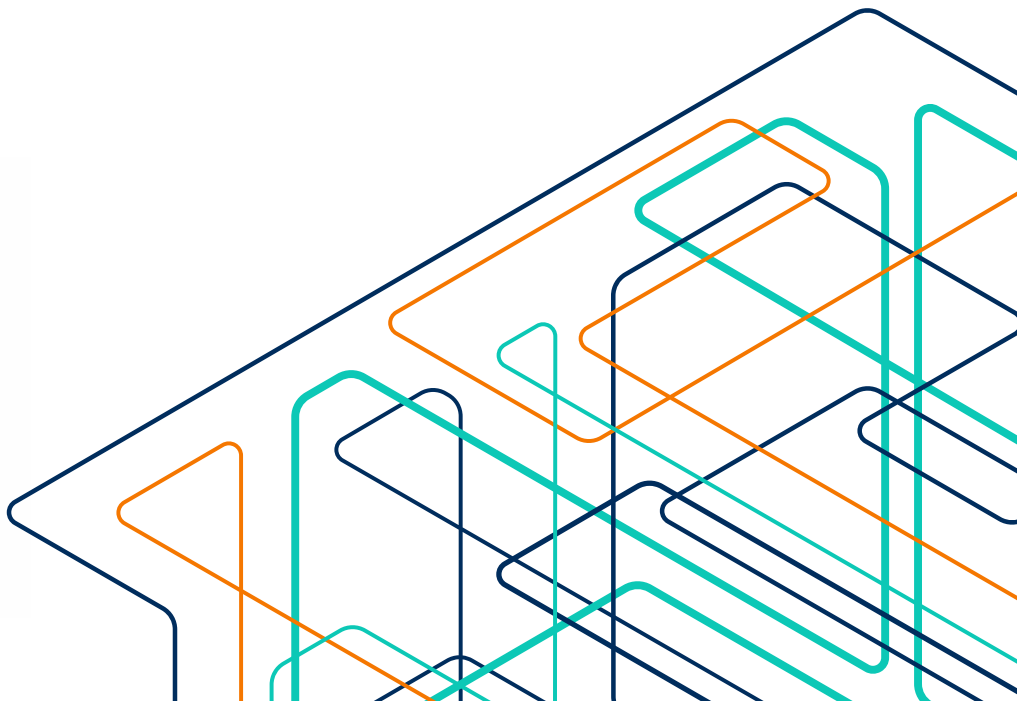
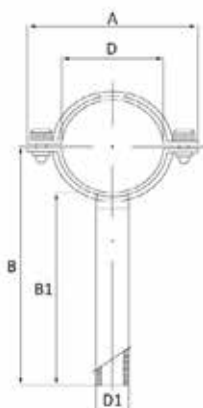

SMS PÖÖRDKLAPID

			A		
CEX140	PÖÖRDKLAPP KEEVITATAV SMS	4501 25mm AISI304	40	TK	
ANP163	PÖÖRDKLAPP KEEVITATAV SMS	4501 38mm AISI304	50	TK	
ANP159	PÖÖRDKLAPP KEEVITATAV SMS	4501 51mm AISI304	50	TK	
ANP162	PÖÖRDKLAPP KEEVITATAV SMS	4501 63,5mm AISI304	50	TK	
CEX139	PÖÖRDKLAPP KEEVITATAV SMS	4501 76,1mm AISI304	60	TK	



CEX140

CNV900	PÖÖRDKLAPP KEEVITATAV SMS	25mm AISI316			
CNV898	PÖÖRDKLAPP KEEVITATAV SMS	38mm AISI316			
CNV899	PÖÖRDKLAPP KEEVITATAV SMS	51mm AISI316			
CNV896	PÖÖRDKLAPP KEEVITATAV SMS	63,5mm AISI316			
CNV897	PÖÖRDKLAPP KEEVITATAV SMS	76,1mm AISI316			

			A		
ANP164	PÖÖRDKLAPP SMS-KEEVIS/KEERE	4502 51mm GS 1.4301	61	TK	T
ANP165	PÖÖRDKLAPP SMS-KEEVIS/KEERE	4502 63,5mm GS 1.4301	63	TK	T



ANP164

			A		
ANP160	PÖÖRDKLAPP SMS-KEERE/KEERE	4503 SMS 51mm GG 1.4301	72	TK	T
ALO482	PÖÖRDKLAPI TIHEND VMQ, SILIKOON	DN25 PUNANE		TK	
ALO483	PÖÖRDKLAPI TIHEND VMQ, SILIKOON	DN40 PUNANE		TK	
ALO484	PÖÖRDKLAPI TIHEND VMQ, SILIKOON	DN50 PUNANE		TK	
ALO485	PÖÖRDKLAPI TIHEND VMQ, SILIKOON	DN65 PUNANE		TK	
ALO477	PÖÖRDKLAPI TIHEND EPDM, MUST	DN40		TK	T
ALO478	PÖÖRDKLAPI TIHEND EPDM, MUST	DN50		TK	T
ALO479	PÖÖRDKLAPI TIHEND EPDM, MUST	DN65		TK	T
ALO480	PÖÖRDKLAPI TIHEND EPDM, MUST	DN80		TK	T

onninen

AS Onninen on tehniliste kaupade hulгимüügi ettevõte, mis pakub toote- ning infolahendusi elektri-, kütte-, veevarustuse-, kanalisatsiooni-, ventilatsiooni-, jahutuse- ja külmatehnika valdkonna professionaalidele – ehitajatele, paigaldusfirmadele, kinnisvarahaldajatele ja tööstusettevõtetele, aga samuti ka avalikule sektorile ning kaubandusettevõtetele.

Kuulume rahvusvahelisse Kesko Gruppi, Ehituse ning Tehnilise Kaubanduse divisjoni. Divisjon tegutseb kaheksas riigis ning selles töötab ligikaudu 18 000 kaubandussektori spetsialisti. Meie tegevus põhineb kindlatel väärtustel ja pikaajalistel eesmärkidel.

Üle Eesti on avatud 8 esindusüksust, Onninen Expressi ning logistikakeskus Jüris.

KVALITEET

Onninen on sertifitseeritud vastavalt tegevusjuhtimise standardile ISO9001 ja keskkonnajuhtimise standardile ISO 14001



Onninen AS
Betooni 6/2, 13816 Tallinn
Telefon: +372 6105 500
infoestonia@onninen.com

toostus@onninen.com
Telefon: +372 6105 530

Külasta meie kodulehte ja e-poodi:
www.onninen.ee

Onninen Express Lasnamäe

Betooni 6/2, 13816 Tallinn

Telefon: 6105 593

E-mail: lasnamae@onninen.com

Onninen Express Tännassilma

Valdmäe põik 2, Tännassilma, Laagri

Telefon: 5656 8250

E-mail: tanassilma@onninen.com

Onninen Express Mustamäe

Laki 13, 12915 Tallinn

Telefon: 6644 030

E-mail: mustamae@onninen.com

Onninen Express Kalamaja

Erika 14, 10416 Tallinn

Telefon: 5384 1600

E-mail: kalamaja@onninen.com

Onninen Express Tartu

Tehnika 30, 50104 Tartu

Telefon: 51 941 700

E-mail: tartu@onninen.com

Onninen Express Jõhvi

Linda 15c, 41536 Jõhvi

Telefon: 3364 260

E-mail: johvi@onninen.com

Onninen Express Pärnu

Kirsi 48, 80010 Pärnu

Telefon: 56 857 500

E-mail: parnu@onninen.com

Onninen Narva Express

Vahtra 5, 21003 Narva

Telefon: 59 181 645

E-mail: narva@onninen.com

Logistikakeskus ja laomüük

Taevavärava tee 2, Rae vald, 75306 Harjumaa

Telefon: 5329 2703, 5381 4421

E-mail: stockgroup@onninen.com



Onninen Eesti