

uponor

Tootekataloog 2020

Põrandakütte- ja jahutuse lahendused,
torustikud, soojasõlmed, ventilatsioon



ÜHISED OMADUSED: ILMA ÜHENDUSMOODULITA:

- Automaatne tasakaalustus
- Lihtne kasutamine
- Kõikvõimalikeks lahendusteks ja erinevateks paigalduskohtades
- Laiendatav lisamooduliga

ÜHENDUSMOODULIGA:

- Kodu / eemal seadistus
- Andmete kogumine ja diagnostika
- Nutitelefoni kasutamine juhtpaneelina
- Lihtne kasutuselevõtt ja seadistamine. Kaughaldus nutitelefoni ja äpi abil
- Võimalus lubada kolmandate osapoolte ligipääs süsteemile (paigaldus- või hooldusettevõtte)
- Süsteemi teated ja alarmid reaalajas
- Mitme eri paigalduse (näiteks linnakodu / suvila) juhtimine sama äpiga
- Ajaprogrammid
- Turvaline pilveühendus
- Automaatsed tarkvarauuendused interneti kaudu
- Integreeritud Targa Kodu ühendusvõimalused (näiteks Amazon Alexa)
- Avatud API lähtekood

JUHTMEVABA 24V

| Komplektus | Ilma ühendusmoodulita | Ühendusmooduliga |
|--|---|----------------------------------|
| Jahutus võimalik*** | Ei | Jah |
| Kuni 6 termostaati ja 8 ajamit | Smatrix Wave Pulse X-265 | Smatrix Wave Pulse X-265 + R-208 |
| Lisamoodul Lisaks 6 termostaati ja 6 ajamit | M-262 | M-262 |
| Peamine ruumitermostaat | T-165 | T-169** |
| Valikulised ruumitermostaadid | T-161 | T-161 |
| | T-166 | T-166 |
| | T-169** | T-165 |
| | T-163 | T-163 |
| Paigaldusraam | A-1XX Sobib toodetele T-163, T-165, T-166 | |
| Põranda-andur | S-1XX Sobib toodetele T-169, T-161, T-166, T-163 | |

JUHTMEGA 24 V

| Komplektus | Modbus/KNX | Ilma ühendusmoodulita | Ühendusmooduliga |
|--|---|--------------------------|----------------------------------|
| Jahutus võimalik*** | Jah*** | Ei | Jah*** |
| Kontroller Kuni 6 termostaati ja 8 ajamit | Smatrix Base PRO X-147 | Smatrix Base Pulse X-245 | Smatrix Base Pulse X-245 + R-208 |
| Lisamoodul Lisaks 6 termostaati ja 6 ajamit | M-140 | M-242 | M-242 |
| Peamine ruumitermostaat ja vajalikud lisaseadmed | T-149** | T-145 | T-149** |
| | R-147 (KNX) | | |
| | I-147 (KNX) | | |
| Valikulised ruumitermostaadid | T-141 | T-141 | T-141 |
| | T-146 | T-146 | T-146 |
| | T-145 | T-149** | T-145 |
| | T-143 | T-143 | T-143 |
| | | | |
| Paigaldusraam | A-1XX Sobib toodetele T-143, T-145, T-146 | | |
| | Monteerimisraam A-14X Sobib termostaadile T-149 | | |
| Põranda-andur | S-1XX Põranda-andur Sobib toodetele T-149, T-146, T-143 | | |

Termostaatide seadevahemik 5–35°C

* Plus X Award- innovatsiooniahind kvaliteedi, väljatöötamise, kasutusmugavuse ja ökoloogilisuse eest

** Jahutusrežiimiga süsteemides kasutage alati niiskusanduriga termostaate T-169, T-161, T-149

*** Ei sobi Uponor EPGj6 pumbarühmaga

| JUHTMEVABA 24 V | Uponor-nr |
|--|-----------|
| X265 Kontroller Smatrix Wave Plus | 1093021 |
| X265 Kontroller ja ühendusmoodul R-208 | 1093024 |
| M-262 Lisamoodul | 1093133 |
| T-165 Termostaat | 1086980 |
| T-161 Termostaat | 1087815 |
| T-166 Termostaat | 1086982 |
| T-169 Termostaat valge | 1087816 |
| T-169 Termostaat must | 1087817 |
| T-163 Termostaat avalikesse ruumidesse | 1086979 |
| R-208 Ühendusmoodul | 1093030 |
| A-1XX Paigaldusraam | 1086986 |
| S-1XX Põranda- ja välisandur | 1071684 |

| JUHTMEGA 24 V | Uponor-nr |
|---|-----------|
| X-245 Kontroller Smatrix Base Pulse | 1093017 |
| X-245 Kontroller Smatrix Base Pulse + R-208 ühendusmoodul | 1093019 |
| X-147 Kontroller Smatrix Base Pro | 1087162 |
| M-140 Kontrolleri lisamoodul | 1071686 |
| M-242 Kontrolleri lisamoodul | 1093134 |
| T-141 Termostaat | 1087812 |
| T-145 Termostaat | 1086975 |
| T-146 Termostaat | 1086976 |
| T-149 Termostaat valge | 1087813 |
| T-149 Termostaat must | 1087814 |
| T-143 Termostaat avalike ruumide jaoks | 1086972 |
| R-208 Ühendusmoodul | 1093030 |
| R-147 KNX-moodul | 1087164 |
| I-147 Juhtpaneel (KNX) | 1087161 |
| A-1XX Paigaldusraam | 1086986 |
| A-14X Monteerimisraam | 1087821 |
| S-1XX Põranda- ja välisandur | 1071684 |

JUHTMEVABA STARDIPAKETT

S- kontroller X-265 + ühendusmoodul R-208+ 3 termostaati T-169
L- 2 kontrollerit X-265 + ühendusmoodul R-208+ 5 termostaati T-169
Stardipaketit ainult valgete termostaatidega!



JUHTMEGA STARDIPAKETT

S- kontroller X-245 + ühendusmoodul R-208+ 3 termostaati T-149
L- 2 kontrollerit X-245 + ühendusmoodul R-208+ 5 termostaati T-149
Stardipaketit ainult valgete termostaatidega!



Spetsiaalselt Uponori paigaldajatele – korja uPoints punkte ja saa auhindu!



Oled usaldanud meid ja meie tooteid. Meie soovime tänada – preemiaprogrammiga Uponor & More. Lihtsalt kogu uPoints punkte ostes valitud Uponori tooteid ja saad valida suure hulga kingituste vahel.

See on nii lihtne: www.uponor-more.com/ee



1. Registreeri

Registreeri, et ühineda programmiga ja naudi erinevaid Uponor & More'i eeliseid!



2. Korja punkte

uPoints punkte saab paljude Uponori põhitoodete eest. Lihtsalt sisesta unikaalne kood Uponor & More veebilehel www.uponor-more.com/ee ja täida oma konto. Või skänni punktid Uponor PRO äpiga.



3. Vali auhindu

Nüüd Uponor & More programmi parima osa juurde! Kui oled kogunud piisavalt preemiaprogrammi punkte, saad need vahetada põnevate kingituste vastu!



Uponor

Uponor Ecoflex Quattro Midi

Uus, väiksema läbimõõduga eelisoleeritud toru kütte- ja sooja vee edastamiseks hoonest hoonesse.

Tavatorust 20%
soodsam hind

Quattro Midi eelised:

- ✓ 14% väiksem soojuskadu
- ✓ 15% parem painduvus
- ✓ Mugavam transport, sest väiksem rull

Sisukord

| | |
|--|----------------|
| 1. Uponor komposiitorusüsteemid | 3–33 |
| 1.1 Torud | 3–6 |
| 1.2 Torude kinnitusklambrid | 7 |
| 1.3 Liitmikud | 8–25 |
| 1.4 RS- moodulliitmikud | 26–29 |
| 1.5 UNI-X ja UNI-C kollektorid | 30–33 |
| 2. Uponor Flex plasttorusüsteemid | 34–56 |
| 2.1 PEX torud | 34–37 |
| 2.2 Liitmikud QjaE | 38–49 |
| 2.3 Aqua Plus lekkekindel veesüsteem | 50–54 |
| 2.4 RS plasttorule | 55–56 |
| 3. Uponor põrandakütte- ja jahutussüsteemid | 57–123 |
| 3.1 Põrandaküttetorud | 57–59 |
| 3.2 Põrandakütte paigaldussüsteemid | 60–71 |
| 3.3 Kollektorid ja kollektorkapid | 72–77 |
| 3.4 Pealevooluautomaatika (pumbagrupid) | 78–90 |
| 3.5 Ruumitemperatuuri juhtimisseadmed (kontrollerid, termostaadid, andurid) | 91–120 |
| 3.6 Ajamid | 121–123 |
| 4. Uponor elektriline põrandaküte | 124–128 |
| 5. Uponor eelisoleeritud torud ja liitmikud | 129–152 |
| 6. Uponor ventilatsioon | 153–158 |
| 7. Uponor Port, soojasõlmed | 159–167 |
| 8. Uponor tööriistad | 168–179 |

Lühendid

| Lühendid | Pakend | Nimetus |
|-----------|----------------------|----------------------------|
| A | [m ²] | pindala |
| c/c | [mm] | telgede vahe |
| c/c1 | [mm] | tsenter - tsentri kaugus 1 |
| d | [mm] | läbimõõt |
| d1 | [mm] | läbimõõt 1 |
| d2 | [mm] | läbimõõt 2 |
| d3 | [mm] | läbimõõt 3 |
| DN | [mm] | nominaalläbimõõt |
| G | [kN/m ²] | kandevõime |
| h | [mm] | kõrgus |
| h1 | [mm] | kõrgus 1 |
| h2 | [mm] | kõrgus 2 |
| KA | [d] | kuivamisaeag päevades |
| kulu | [l/m ²] | kulu |
| l | [mm] | pikkus |
| L | [m] | pikkus meetrites |
| l1 | [mm] | pikkus 1 |
| p/a | [W] | võimsus ajami kohta |
| p | [bar] | rõhk |
| P | [W] | tegelik võimsus |
| R-arv | [m ² K/W] | soojustakistus |
| s | [mm] | paksus / seina paksus |
| SK | [°] | sisekeere |
| SK | [-] | sisekeere (meeterkeere) |
| TP | [V] | toitepinge |
| Tüüp | [-] | tüüp |
| ÜK | [mm] | ülekate |
| V | [l/m] | mahutavus |
| väljundid | [-] | väljundite arv |
| värvus | [-] | värvus |
| VK_m | [-] | väliskeere (meeterkeere) |
| VK | [°] | väliskeere |
| w | [mm] | laius |
| W | [m] | laius |
| w1 | [mm] | laius 1 |
| w2 | [mm] | laius 2 |
| Kaal | [kg] | ühiku kaal |
| z | [mm] | z- arv |
| ΔLw | [dB] | löögimüra sumbumine |

Uponor Uni Pipe PLUS



Uponor Uni Pipe PLUS on unikaalne keevituseta alumiiniumkihiga komposiit-toru kasutamiseks tarbevee-, kütte- ja jahutussüsteemides.

Eelised

- Kevvituseta alumiiniumkiht.
- Hea kujustabiilsus, väike joonpaisumine
- Parendatud paindumus
- 100% hapniku difusioonikindel
- Kerge



Kirjeldus

- Hapniku difusioonikindel mitmekihiline komposiit-toru (PE-RT - sidekiht – keevituseta alumiinium - sidekiht - PE-RT).
- Toodetud SACP-tehnoloogia kohaselt.
- Tuleklass E vastavalt EN 13501-1.
- Hügieeniliselt suletud otstega vastavalt EN 806.

Kasutusala

- Testitud/hea kiidetud vastavalt EN ISO 21003, kasutusklass 1,2,4,5/10bar
- Tarbevesi: püsiv töötemperatuur 0°C kuni 70°C maksimaalsel püsival rõhul 10 bar. Lühiajaline avariitemperatuur 95°C kuni 100 tundi kasutusaja jooksul.
- Küte: püsiv töötemperatuur kuni 80°C maksimaalsel püsival rõhul kuni 10 bar. Lühiajaline avariitemperatuur 100°C kuni 100 tundi kasutusaja jooksul.

Uponor Uni Pipe PLUS valge S

- latt

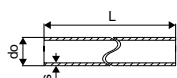

| Art. nr. | Dimension | L do s m mm mm | 2. pak. | pakend UOM |
|----------|------------|-------------------|---------|------------|
| 1059572 | 16x2,0 5m | 5 16 2,0 | 125 | 5 m |
| 1059573 | 20x2,25 5m | 5 20 2,25 | 85 | 5 m |
| 1059574 | 25x2,5 5m | 5 25 2,5 | 55 | 5 m |
| 1059575 | 32x3,0 5m | 5 32 3 | 35 | 5 m |

Uponor MLC toru valge S

- latt

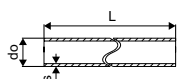

| Art. nr. | Dimension | L do s m mm mm | 2. pak. | pakend UOM |
|----------|-------------|-------------------|---------|------------|
| 1013446 | 40x4,0 5m | 5 40 4,0 | 20 | 5 m |
| 1013449 | 50x4,5 5m | 5 50 4,5 | 20 | 5 m |
| 1013451 | 63x6,0 5m | 5 63 6,0 | 15 | 5 m |
| 1013453 | 75x7,5 5m | 5 75 7,5 | 5 | 5 m |
| 1013455 | 90x8,5 5m | 5 90 8,5 | 5 | 5 m |
| 1013457 | 110x10,0 5m | 5 110 10,0 | 5 | 5 m |

Uponor Uni Pipe PLUS

Uponor Uni Pipe PLUS valge

■ rull

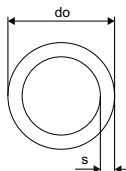

| Art. nr. | Dimension | L m | do mm | s mm | | 2. pak. | pakend | UOM |
|----------------|--------------|--------|----------|---------|--|---------|--------|-------|
| 1059577 | 16x2,0 200m | 200 | 16 | 2 | | 900 | 2600 | 200 m |
| 1059579 | 20x2,25 100m | 100 | 20 | 2,25 | | 700 | 1300 | 100 m |
| 1059581 | 25x2,5 50m | 50 | 25 | 2,5 | | 800 | 700 | 50 m |
| 1059583 | 32x3,0 50m | 50 | 32 | 3 | | 1000 | 400 | 50 m |

Uponor MLC isoleeritud

Kirjeldus

- Koosneb torust ja isolatsioonikihist.
- Rullides.
- Ekstrusiooni teel valmistatud isolatsioon on valmistatud suletud pooridega vahtpolüetüleenist.
- Kaetud tugeva kilekattega

Uponor Uni Pipe PLUS valge toru sinise isolatsiooniga S6 WLS 040

Isolatsiooni paksus 6 mm

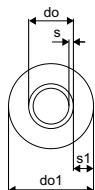

NEW
NEW
NEW

| Art. nr. | Dimension | L m | do mm | do1 mm | s mm | s1 mm | värvus | uPoints | 2. pak. | pakend | UOM |
|----------------|------------------|--------|----------|-----------|---------|----------|--------|---------|---------|--------|------|
| 1091723 | 16x2,0 blue 75m | 75 | 16 | 28 | 2,0 | 6,0 | sinine | | 700 | 600 | 75 m |
| 1091724 | 20x2,25 blue 75m | 75 | 20 | 32 | 2,25 | 6,0 | sinine | | 900 | 600 | 75 m |
| 1091725 | 25x2,5 blue 50m | 50 | 25 | 37 | 2,5 | 6,0 | sinine | | 1050 | 400 | 50 m |

Uponor Uni Pipe PLUS

Uponor Uni Pipe PLUS kaitsehülsis

Kirjeldus

toru kaitsehülsis

rullites

hülsstoru materjal : gofreeritud polüetüleen

Uponor Uni Pipe PLUS valge toru, sinises ja punases hülsis

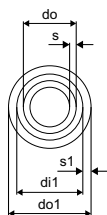

| Art. nr. | Dimension | L m | di1 mm | do mm | do1 mm | s mm | värvus - | uPoints | 2. pak. | pakend | UOM |
|----------------|--------------------------|--------|-----------|----------|-----------|---------|-------------|---------|---------|--------|-----|
| 1063061 | 16x2,0 - 25/20 red 75m | 75 | 20 | 16 | 25 | 2,0 | punane | 500 | 1350 | 75 | m |
| 1063059 | 16x2,0 - 25/20 blue 75m | 75 | 20 | 16 | 25 | 2,0 | sinine | 500 | 1350 | 75 | m |
| 1063062 | 20x2,25 - 28/23 red 75m | 75 | 23 | 20 | 28 | 2,25 | punane | 800 | 900 | 75 | m |
| 1063060 | 20x2,25 - 28/23 blue 75m | 75 | 23 | 20 | 28 | 2,25 | sinine | 800 | 900 | 75 | m |

Uponor Metallic Pipe PLUS



Uponor Metallic Pipe PLUS on unikaalne kroomiläikelise pinnaga komposiittoru. Tänu kõrge viimistlusastmega välispinnale sobib ideaalselt nähtavaks paigalduseks.

Eelised

- Sarnaneb väliselt metalltorule
- Keevituseta alumiiniumkiht
- Hea kujupüsivus
- Kerge: lihtne käsitleda ja paigaldada



Kirjeldus

- Hapniku difusioonikindel mitmekihiline komposiittoru (PE-RT - sidekiht – keevituseta alumiinium - pinnakate) . Kroomiläikelise pinnaga. Toodetud SACP tehnoloogia kohaselt.
- Tuleklass E vastavalt EN 13501-1.
- Hügieeniliselt suletud otstega vastavalt EN 806.

Kasutusala

- Tarbevesi: püsiv töötemperatuur 0°C kuni 70°C maksimaalsel püsival rõhul 10 bar. Lühiajaline avariitemperatuur 95°C 100 tundi kasutusaja jooksul.
- Küte: püsiv töötemperatuur kuni 80°C maksimaalsel püsival rõhul kuni 10 bar. Lühiajaline avariitemperatuur 100°C 100 tundi kasutusaja jooksul.

Uponor Metallic Pipe PLUS S

- Metallic Pipe PLUS

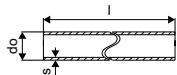

| Art. nr. | Dimension | L | do | s | 2. pak. | pakend | UOM |
|----------------|------------|---|----|------|---------|--------|-----|
| | | m | mm | mm | | | |
| 1088400 | 16x2,0 3m | 3 | 16 | 2,0 | 75 | 3 | m |
| 1088401 | 20x2,25 3m | 3 | 20 | 2,25 | 48 | 3 | m |

Uponor Uni

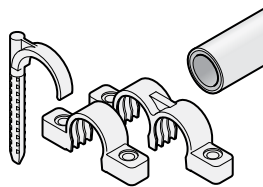

Uponor torude kinnitusklambrid

Eelised

- Kiire paigaldus
- Lihtne kasutada



Uponor Teck hülsi klamber

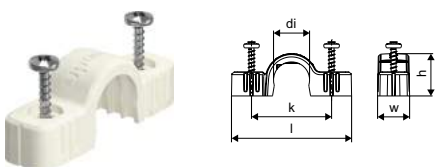

| Art. nr. | Dimension | l | di | h | k | w | värvus | 2. pak. | pakend | UOM |
|----------------|-----------|----|----|----|----|----|--------|---------|--------|-----|
| | | mm | mm | mm | mm | mm | - | | | |
| 1063472 | 25mm | 67 | 25 | 28 | 47 | 16 | valge | 600 | 100 | tk |
| 1063474 | 28mm | 70 | 28 | 31 | 50 | 16 | valge | 600 | 100 | tk |

Uponor Teck hülsi kaksikklamber

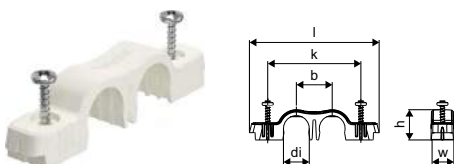

| Art. nr. | Dimension | l | di | b | h | k | w | värvus | 2. pak. | pakend | UOM |
|----------------|-----------|-----|----|----|----|----|----|--------|---------|--------|-----|
| | | mm | mm | mm | mm | mm | mm | - | | | |
| 1063473 | 25mm | 105 | 25 | 32 | 28 | 80 | 16 | valge | 360 | 60 | tk |
| 1063475 | 28mm | 111 | 28 | 35 | 31 | 86 | 16 | valge | 360 | 60 | tk |

Uponor MLC toruklamber, valge



| Art. nr. | Dimension | d | 2. pak. | pakend | UOM |
|----------------|-----------|-------|---------|--------|-----|
| | | mm | | | |
| 1083931 | 16-20 | 16-20 | 10 | 1 | tk |
| 1083932 | 25-32 | 25-32 | 10 | 1 | tk |

Uponor MLC toru kaksikklamber, valge



| Art. nr. | Dimension | d | c/c | 2. pak. | pakend | UOM |
|----------------|-----------|-------|-----|---------|--------|-----|
| | | mm | mm | | | |
| 1083933 | 16-20 | 16-20 | 40 | 10 | 1 | tk |
| 1083934 | 25-32 | 25-32 | 60 | 10 | 1 | tk |

Uponor S-Press PLUS

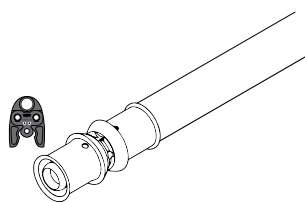

S-Press PLUS on uus pressliitmike põlvkond, mis tagab kestvad toruühendused. Ühildub 100% olemasolevate Uponor komposiitorude ja tööriistadega. Läbimõõtu- dele 16 kuni 32 mm. Nii metall- kui ka plastliitmikud.

Eelised

- **TUGEV:** talub ka raskeimaid tingimusi
- **OHUTU:** tagab perfektse pressimistulemuse
- **LIHTNE:** lihtsustab projekteerimist ja paigaldamist
- **NUTIKAS:** Presshülslil oleva QR koodi abil kiire ligipääs tehnilisele infole



Kirjeldus

- Roostevabast terasest presshülss, kontrollavaga
- Täpne presspea asendi fikseerimine liitmikul
- Unikaalne pressimisindikaator
- Liitmiku läbimõõdu kiire tuvastamine
- Lekkeindikatsiooniga liitmikud
- Kiire 3-töövõttega paigaldus
- 100% sobivus olemasolevate Uponor komposiitorudega
- Innovaatiline QR kood kiireks juurdepääsuks digiandmetele

Kasutusala

- Tarbevesi: püsiv töötemperatuur 0°C kuni 70°C maksimaalsel püsival tööõhul 10 bar. Lühiajaline avariitemperatuur 95°C 100 tundi kasutusaja jooksul.
- Küte: püsiv töötemperatuur kuni 80°C maksimaalsel püsival tööõhul 10 bar. Lühiajaline avariitemperatuur 100°C 100 tundi kasutusaja jooksul.

Sertifitseerimine

- DVGW
- AENOR

Uponor S-Press PLUS/ S-Press, materjal PPSU

Kirjeldus

- Parendatud volutakistusega plastliitmikud, materjal PPSU

Uponor S-Press PLUS põlv PPSU

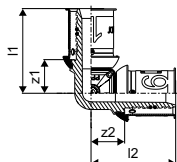

| Art. nr. | Dimension | l1 mm | l2 mm | z1 mm | z2 mm | 2. pak. | pakend | UOM |
|-----------------------|-----------|----------|----------|----------|----------|---------|--------|-----|
| NEW 1039929 | 16-16 | 33 | 33 | 13 | 13 | 80 | 10 | tk |
| NEW 1039930 | 20-20 | 37 | 37 | 16 | 16 | 80 | 10 | tk |
| NEW 1039931 | 25-25 | 48 | 48 | 19 | 19 | 40 | 5 | tk |
| NEW 1039932 | 32-32 | 51 | 51 | 23 | 23 | 20 | 5 | tk |

Uponor S-Press PLUS

Uponor S-Press põlv PPSU

■ Värvkood

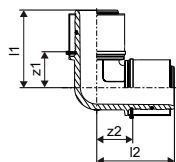

| Art. nr. | Dimension | l1 mm | l2 mm | z1 mm | z2 mm | pakend | UOM |
|----------------|-----------|----------|----------|----------|----------|--------|-----|
| 1046386 | 40-40 | 68 | 68 | 29 | 29 | 5 | tk |
| 1046387 | 50-50 | 73 | 73 | 34 | 34 | 3 | tk |
| 1032877 | 63-63 | 101 | 101 | 40 | 40 | 1 | tk |
| 1032878 | 75-75 | 108 | 108 | 47 | 47 | 1 | tk |

Uponor S-Press PPSU

■ Värvkood

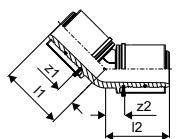

| Art. nr. | Dimension | l1 mm | l2 mm | z1 mm | z2 mm | pakend | UOM |
|----------------|-----------|----------|----------|----------|----------|--------|-----|
| 1032879 | 63-63 | 83 | 83 | 23 | 23 | 1 | tk |
| 1032880 | 75-75 | 86 | 86 | 25 | 25 | 1 | tk |

Uponor S-Press PLUS jätk PPSU

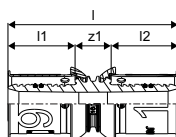

| Art. nr. | Dimension | l mm | l1 mm | l2 mm | z1 mm | 2. pak. | pakend | UOM |
|----------------|-----------|---------|----------|----------|----------|---------|--------|-----|
| 1039933 | 16-16 | 51 | 20 | 20 | 11 | 80 | 10 | tk |
| 1039934 | 20-20 | 54 | 21 | 21 | 11 | 80 | 10 | tk |
| 1039935 | 25-25 | 68 | 28 | 28 | 11 | 40 | 5 | tk |
| 1039936 | 32-32 | 69 | 28 | 28 | 13 | 40 | 5 | tk |

Uponor S-Press plastjätk PPSU

■ Värvkood

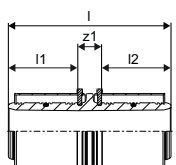

| Art. nr. | Dimension | l mm | l1 mm | l2 mm | z1 mm | pakend | UOM |
|----------------|-----------|---------|----------|----------|----------|--------|-----|
| 1046401 | 40-40 | 91 | 39 | 39 | 13 | 5 | tk |
| 1046402 | 50-50 | 91 | 39 | 39 | 13 | 3 | tk |
| 1032881 | 63-63 | 137 | 61 | 61 | 15 | 1 | tk |
| 1032882 | 75-75 | 137 | 61 | 61 | 15 | 1 | tk |

Uponor S-Press PLUS

Uponor S-Press PLUS siirdmik PPSU

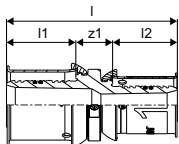

NEW
NEW
NEW
NEW

| Art. nr. | Dimension | l mm | l1 mm | l2 mm | z1 mm | 2. pak. | pakend | UOM |
|----------|-----------|---------|----------|----------|----------|---------|--------|-----|
| 1039937 | 20-16 | 53 | 21 | 20 | 11 | 80 | 10 | tk |
| 1039938 | 25-16 | 60 | 28 | 20 | 11 | 40 | 5 | tk |
| 1039939 | 25-20 | 61 | 28 | 21 | 11 | 40 | 5 | tk |
| 1039940 | 32-25 | 69 | 28 | 28 | 13 | 40 | 5 | tk |

Uponor S-Press siirdmik PPSU

■ Värvkood

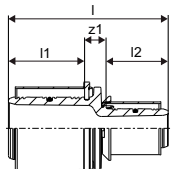

NEW
NEW
NEW
NEW
NEW
NEW
NEW
NEW

| Art. nr. | Dimension | l mm | l1 mm | l2 mm | z1 mm | pakend | UOM |
|----------|-----------|---------|----------|----------|----------|--------|-----|
| 1039941 | 40-25 | 80 | 39 | 28 | 12 | 5 | tk |
| 1039942 | 40-32 | 80 | 39 | 28 | 13 | 5 | tk |
| 1039943 | 50-32 | 80 | 39 | 28 | 13 | 3 | tk |
| 1046406 | 50-40 | 91 | 39 | 39 | 13 | 3 | tk |
| 1032883 | 63-40 | 115 | 61 | 37 | 17 | 1 | tk |
| 1032884 | 63-50 | 115 | 61 | 37 | 17 | 1 | tk |
| 1032885 | 75-50 | 115 | 61 | 37 | 17 | 1 | tk |
| 1032886 | 75-63 | 137 | 61 | 59 | 17 | 1 | tk |

Uponor S-Press PLUS kolmik PPSU

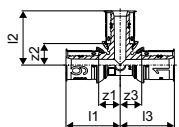

NEW
NEW
NEW
NEW

| Art. nr. | Dimension | l1 mm | l2 mm | l3 mm | z1 mm | z2 mm | z3 mm | 2. pak. | pakend | UOM |
|----------|-----------|----------|----------|----------|----------|----------|----------|---------|--------|-----|
| 1039944 | 16-16-16 | 33 | 33 | 33 | 13 | 13 | 13 | 80 | 10 | tk |
| 1039945 | 20-20-20 | 37 | 37 | 37 | 16 | 16 | 16 | 40 | 10 | tk |
| 1039946 | 25-25-25 | 48 | 48 | 48 | 19 | 19 | 19 | 20 | 5 | tk |
| 1039947 | 32-32-32 | 51 | 51 | 51 | 23 | 23 | 23 | 20 | 5 | tk |

Uponor S-Press kolmik PPSU

■ Värvkood

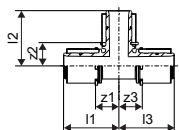

NEW
NEW
NEW
NEW

| Art. nr. | Dimension | l1 mm | l2 mm | l3 mm | z1 mm | z2 mm | z3 mm | pakend | UOM |
|----------|-----------|----------|----------|----------|----------|----------|----------|--------|-----|
| 1046390 | 40-40-40 | 68 | 68 | 68 | 29 | 29 | 29 | 5 | tk |
| 1046391 | 50-50-50 | 73 | 73 | 73 | 33 | 33 | 33 | 3 | tk |
| 1032887 | 63-63-63 | 101 | 101 | 101 | 42 | 40 | 42 | 1 | tk |
| 1032888 | 75-75-75 | 108 | 107 | 108 | 47 | 47 | 47 | 1 | tk |

Uponor S-Press PLUS

Uponor S-Press PLUS erikolmik PPSU

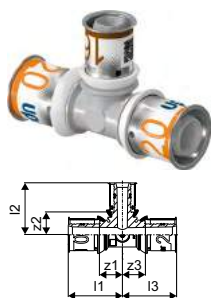

| Art. nr. | Dimension | l1 mm | l2 mm | l3 mm | z1 mm | z2 mm | z3 mm | 2. pak. | pakend | UOM |
|------------------------------|-----------|----------|----------|----------|----------|----------|----------|---------|--------|-----|
| NEW 1039948 | 16-20-16 | 35 | 35 | 35 | 15 | 13 | 15 | 40 | 10 | tk |
| NEW 1039949 | 20-16-16 | 37 | 36 | 36 | 16 | 16 | 16 | 40 | 10 | tk |
| NEW 1039950 | 20-16-20 | 37 | 36 | 37 | 16 | 16 | 16 | 40 | 10 | tk |
| NEW 1039951 | 20-20-16 | 37 | 37 | 36 | 16 | 16 | 16 | 40 | 10 | tk |
| NEW 1039952 | 20-25-20 | 41 | 48 | 41 | 19 | 19 | 19 | 40 | 10 | tk |
| NEW 1039953 | 25-16-16 | 48 | 39 | 39 | 19 | 19 | 19 | 40 | 5 | tk |
| NEW 1039954 | 25-16-20 | 48 | 39 | 41 | 19 | 19 | 19 | 40 | 5 | tk |
| NEW 1039955 | 25-16-25 | 48 | 39 | 48 | 19 | 19 | 19 | 40 | 5 | tk |
| NEW 1039956 | 25-20-20 | 48 | 41 | 41 | 19 | 19 | 19 | 40 | 5 | tk |
| NEW 1039957 | 25-20-25 | 48 | 41 | 48 | 19 | 19 | 19 | 40 | 5 | tk |
| NEW 1039958 | 32-16-32 | 51 | 43 | 51 | 23 | 23 | 23 | 40 | 5 | tk |
| NEW 1039959 | 32-20-32 | 51 | 44 | 51 | 23 | 23 | 23 | 40 | 5 | tk |
| NEW 1039960 | 32-25-25 | 51 | 51 | 51 | 23 | 23 | 23 | 40 | 5 | tk |
| NEW 1039961 | 32-25-32 | 51 | 51 | 51 | 23 | 23 | 23 | 40 | 5 | tk |

Uponor S-Press erikolmik PPSU



| Art. nr. | Dimension | l1 mm | l2 mm | l3 mm | z1 mm | z2 mm | z3 mm | pakend | UOM |
|------------------------------|-----------|----------|----------|----------|----------|----------|----------|--------|-----|
| NEW 1039962 | 40-20-40 | 68 | 49 | 68 | 29 | 28 | 29 | 5 | tk |
| NEW 1039963 | 40-25-32 | 68 | 56 | 56 | 29 | 28 | 28 | 5 | tk |
| NEW 1039964 | 40-25-40 | 68 | 56 | 68 | 29 | 28 | 29 | 5 | tk |
| NEW 1039965 | 40-32-32 | 68 | 56 | 56 | 29 | 28 | 28 | 5 | tk |
| NEW 1039966 | 40-32-40 | 68 | 56 | 68 | 29 | 28 | 29 | 5 | tk |
| NEW 1039967 | 50-25-40 | 73 | 61 | 73 | 34 | 33 | 34 | 3 | tk |
| NEW 1039968 | 50-25-50 | 73 | 61 | 73 | 34 | 33 | 34 | 3 | tk |
| NEW 1039969 | 50-32-50 | 73 | 61 | 73 | 34 | 33 | 34 | 3 | tk |

Uponor S-Press plast erikolmik PPSU

■ Värvkood

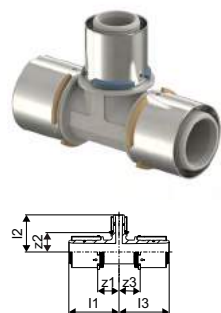

| Art. nr. | Dimension | l1 mm | l2 mm | l3 mm | z1 mm | z2 mm | z3 mm | pakend | UOM |
|------------------------------|-----------|----------|----------|----------|----------|----------|----------|--------|-----|
| NEW 1046400 | 50-40-50 | 73 | 73 | 73 | 33 | 33 | 33 | 3 | tk |
| NEW 1032889 | 63-25-63 | 101 | 68 | 101 | 40 | 39 | 40 | 1 | tk |
| NEW 1032890 | 63-32-63 | 101 | 68 | 101 | 40 | 39 | 40 | 1 | tk |
| NEW 1032891 | 63-40-63 | 101 | 79 | 101 | 40 | 40 | 40 | 1 | tk |
| NEW 1032892 | 75-32-75 | 108 | 74 | 108 | 47 | 45 | 47 | 1 | tk |
| NEW 1032893 | 75-40-75 | 108 | 86 | 108 | 47 | 44 | 47 | 1 | tk |
| NEW 1032894 | 75-50-75 | 108 | 86 | 108 | 47 | 49 | 47 | 1 | tk |

Uponor S-Press PLUS

Uponor S-Press PLUS

Kirjeldus

- Parendatud voolutakistusega korpus
- Tsingikaota DR messing

Uponor S-Press PLUS otsik väliskeere

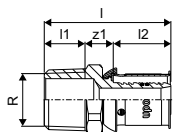

NEW
NEW
NEW
NEW
NEW
NEW
NEW
NEW
NEW

| Art. nr. | Dimension | l mm | l1 mm | l2 mm | R " | z1 mm | 2. pak. | pakend | UOM |
|----------|--------------|---------|----------|----------|--------|----------|---------|--------|-----|
| 1070502 | 16-R1/2"MT | 44 | 14 | 20 | 1/2 | 10 | 80 | 10 | tk |
| 1070503 | 16-R3/4"MT | 46 | 16 | 20 | 3/4 | 11 | 120 | 15 | tk |
| 1070504 | 20-R1/2"MT | 45 | 14 | 21 | 1/2 | 10 | 80 | 10 | tk |
| 1070505 | 20-R3/4"MT | 48 | 15 | 21 | 3/4 | 11 | 80 | 10 | tk |
| 1070506 | 20-R1"MT | 54 | 17 | 21 | 1 | 16 | 40 | 10 | tk |
| 1070507 | 25-R3/4"MT | 55 | 15 | 28 | 3/4 | 11 | 40 | 5 | tk |
| 1070508 | 25-R1"MT | 62 | 18 | 28 | 1 | 16 | 40 | 5 | tk |
| 1070509 | 32-R1"MT | 62 | 17 | 28 | 1 | 16 | 40 | 5 | tk |
| 1070510 | 32-R1 1/4"MT | 66 | 19 | 28 | 1 1/4 | 19 | 20 | 5 | tk |

Uponor S-Press PLUS otsik väliskeere

- keere vastavalt EN ISO 228-1

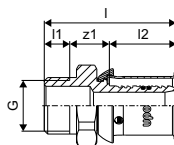

NEW

| Art. nr. | Dimension | l mm | l1 mm | l2 mm | R " | z1 mm | 2. pak. | pakend | UOM |
|----------|------------|---------|----------|----------|--------|----------|---------|--------|-----|
| 1091728 | 16-G3/8"MT | 39 | 8 | 20 | 3/8 | 12 | 80 | 10 | tk |

Uponor S-Press otsik väliskeere

- Tinatud messing
- Värvkood

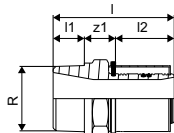

NEW
NEW
NEW
NEW
NEW

| Art. nr. | Dimension | l mm | l1 mm | l2 mm | R " | z1 mm | d mm | pakend | UOM |
|----------|--------------|---------|----------|----------|--------|----------|---------|--------|-----|
| 1046901 | 40-R1 1/4"MT | 78 | 20 | 38 | 1 1/4 | 20 | | 5 | tk |
| 1046902 | 40-R1 1/2"MT | 80 | 20 | 38 | 1 1/2 | 22 | 40 | 5 | tk |
| 1046905 | 50-R1 1/2"MT | 80 | 20 | 38 | 1 1/2 | 22 | 50 | 3 | tk |
| 1032895 | 63-R2"MT | 111 | 28 | 61 | 2 | 22 | | 1 | tk |
| 1032896 | 75-R2 1/2"MT | 110 | 27 | 61 | 2 1/2 | 22 | | 1 | tk |

Uponor S-Press PLUS

Uponor S-Press PLUS otsik sisekeere

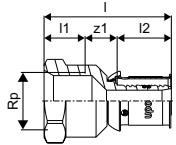

NEW
NEW
NEW
NEW
NEW
NEW
NEW
NEW

| Art. nr. | Dimension | l mm | l1 mm | l2 mm | Rp " | z1 mm | 2. pak. | pakend | UOM |
|----------------|---------------|---------|----------|----------|---------|----------|---------|--------|-----|
| 1070515 | 16-Rp1/2"FT | 47 | 15 | 20 | 1/2 | 12 | 80 | 10 | tk |
| 1070516 | 20-Rp1/2"FT | 47 | 15 | 21 | 1/2 | 10 | 120 | 15 | tk |
| 1070517 | 20-Rp3/4"FT | 51 | 16 | 21 | 3/4 | 14 | 80 | 10 | tk |
| 1070518 | 20-Rp1"FT | 52 | 19 | 21 | 1 | 12 | 80 | 20 | tk |
| 1070519 | 25-Rp3/4"FT | 56 | 17 | 28 | 3/4 | 11 | 40 | 5 | tk |
| 1070520 | 25-Rp1"FT | 59 | 19 | 28 | 1 | 12 | 40 | 5 | tk |
| 1070521 | 32-Rp1"FT | 58 | 20 | 28 | 1 | 10 | 40 | 5 | tk |
| 1070522 | 32-Rp1 1/4"FT | 62 | 21 | 28 | 1 1/4 | 13 | 20 | 5 | tk |

Uponor S-Press otsik sisekeere

- Tinatatud messing
- Värvkood

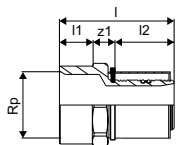

NEW
NEW
NEW

| Art. nr. | Dimension | l mm | l1 mm | l2 mm | Rp " | z1 mm | pakend | UOM |
|----------------|---------------|---------|----------|----------|---------|----------|--------|-----|
| 1046903 | 40-Rp1 1/4"FT | 73 | 21 | 38 | 1 1/4 | 14 | 5 | tk |
| 1046904 | 40-Rp1 1/2"FT | 77 | 21 | 38 | 1 1/2 | 18 | 5 | tk |
| 1046907 | 50-Rp1 1/2"FT | 73 | 21 | 38 | 1 1/2 | 14 | 3 | tk |

Uponor S-Press PLUS põlv

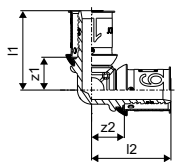

NEW
NEW
NEW
NEW

| Art. nr. | Dimension | l1 mm | l2 mm | z1 mm | z2 mm | 2. pak. | pakend | UOM |
|----------------|-----------|----------|----------|----------|----------|---------|--------|-----|
| 1070523 | 16-16 | 34 | 34 | 14 | 14 | 80 | 10 | tk |
| 1070524 | 20-20 | 37 | 37 | 16 | 16 | 80 | 10 | tk |
| 1070525 | 25-25 | 47 | 47 | 19 | 19 | 40 | 5 | tk |
| 1070526 | 32-32 | 51 | 51 | 23 | 23 | 20 | 5 | tk |

Uponor S-Press PLUS

Uponor S-Press põlv

- Tinatatud messing
- Värvkood

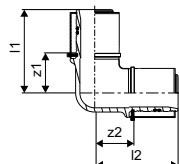

NEW
NEW

| Art. nr. | Dimension | l1 mm | l2 mm | z1 mm | z2 mm | pakend | UOM |
|----------------|-----------|----------|----------|----------|----------|--------|-----|
| 1046908 | 40-40 | 72 | 72 | 34 | 34 | 5 | tk |
| 1046911 | 50-50 | 79 | 79 | 41 | 41 | 3 | tk |

Uponor S-Press PLUS põlv väliskeere

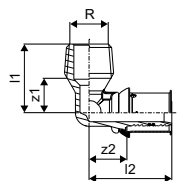

NEW
NEW
NEW
NEW
NEW
NEW

| Art. nr. | Dimension | l1 mm | l2 mm | R " | z1 mm | z2 mm | 2. pak. | pakend | UOM |
|----------------|------------|----------|----------|--------|----------|----------|---------|--------|-----|
| 1070532 | 16-R1/2"MT | 30 | 37 | 1/2 | 15 | 17 | 80 | 10 | tk |
| 1070533 | 20-R1/2"MT | 32 | 41 | 1/2 | 15 | 19 | 80 | 10 | tk |
| 1070534 | 20-R3/4"MT | 34 | 41 | 3/4 | 18 | 19 | 80 | 10 | tk |
| 1070535 | 25-R3/4"MT | 36 | 48 | 3/4 | 20 | 19 | 40 | 5 | tk |
| 1070536 | 25-R1"MT | 43 | 51 | 1 | 22 | 23 | 40 | 5 | tk |
| 1070537 | 32-R1"MT | 43 | 51 | 1 | 22 | 23 | 20 | 5 | tk |

Uponor S-Press põlv väliskeere

- Tinatatud messing
- Värvkood

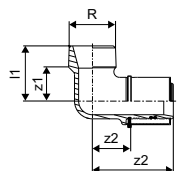

NEW

| Art. nr. | Dimension | l1 mm | l2 mm | R " | z1 mm | z2 mm | pakend | UOM |
|----------------|--------------|----------|----------|--------|----------|----------|--------|-----|
| 1046909 | 40-R1 1/4"MT | 49 | 72 | 1 1/4 | 30 | 34 | 5 | tk |

Uponor S-Press PLUS

Uponor S-Press PLUS põlv sisekeere



| Art. nr. | Dimension | l1 mm | l2 mm | Rp " | z1 mm | z2 mm | 2. pak. | pakend | UOM |
|----------------|-------------|----------|----------|---------|----------|----------|---------|--------|-----|
| 1070539 | 16-Rp1/2"FT | 33 | 38 | 1/2 | 18 | 18 | 80 | 10 | tk |
| 1070540 | 20-Rp1/2"FT | 36 | 41 | 1/2 | 21 | 19 | 80 | 10 | tk |
| 1070541 | 20-Rp3/4"FT | 36 | 43 | 3/4 | 19 | 22 | 40 | 10 | tk |
| 1070542 | 25-Rp3/4"FT | 40 | 50 | 3/4 | 23 | 22 | 20 | 5 | tk |
| 1070543 | 25-Rp1"FT | 45 | 54 | 1 | 25 | 26 | 20 | 5 | tk |
| 1070544 | 32-Rp1"FT | 49 | 54 | 1 | 30 | 26 | 20 | 5 | tk |

Uponor S-Press põlv sisekeere

- Tinatatud messing
- Värvkood

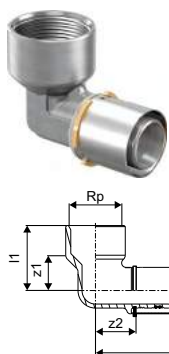

| Art. nr. | Dimension | l1 mm | l2 mm | Rp " | z1 mm | z2 mm | pakend | UOM |
|----------------|---------------|----------|----------|---------|----------|----------|--------|-----|
| 1046910 | 40-Rp1 1/2"FT | 59 | 75 | 1 1/2 | 38 | 37 | 5 | tk |
| 1046912 | 50-Rp1 1/2"FT | 59 | 79 | 1 1/2 | 38 | 41 | 3 | tk |

Uponor S-Press PLUS jätk



| Art. nr. | Dimension | l mm | l1 mm | l2 mm | z1 mm | 2. pak. | pakend | UOM |
|----------------|-----------|---------|----------|----------|----------|---------|--------|-----|
| 1070547 | 16-16 | 51 | 20 | 20 | 12 | 80 | 10 | tk |
| 1070548 | 20-20 | 54 | 21 | 21 | 12 | 80 | 10 | tk |
| 1070549 | 25-25 | 68 | 28 | 28 | 12 | 40 | 5 | tk |
| 1070550 | 32-32 | 68 | 28 | 28 | 12 | 40 | 5 | tk |

Uponor S-Press jätk

- Tinatatud messing
- Värvkood

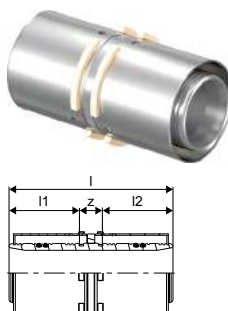

| Art. nr. | Dimension | l mm | l1 mm | l2 mm | z mm | pakend | UOM |
|----------------|-----------|---------|----------|----------|---------|--------|-----|
| 1046932 | 40-40 | 88 | 38 | 38 | 12 | 5 | tk |
| 1046935 | 50-50 | 88 | 38 | 38 | 12 | 3 | tk |

Uponor S-Press PLUS

Uponor S-Press PLUS siirdmik

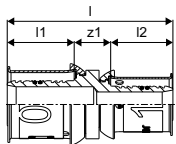

NEW
NEW
NEW
NEW
NEW

| Art. nr. | Dimension | l mm | l1 mm | l2 mm | z1 mm | 2. pak. | pakend | UOM |
|----------------|-----------|---------|----------|----------|----------|---------|--------|-----|
| 1070552 | 20-16 | 53 | 21 | 20 | 12 | 80 | 10 | tk |
| 1070553 | 25-16 | 60 | 28 | 20 | 12 | 40 | 5 | tk |
| 1070554 | 25-20 | 61 | 28 | 21 | 12 | 40 | 5 | tk |
| 1070555 | 32-20 | 61 | 28 | 21 | 12 | 40 | 5 | tk |
| 1070556 | 32-25 | 68 | 28 | 28 | 12 | 40 | 5 | tk |

Uponor S-Press siirdmik

- Tinatatud messing
- Värvkood

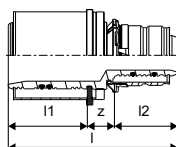

NEW
NEW
NEW
NEW

| Art. nr. | Dimension | l mm | l1 mm | l2 mm | z1 mm | pakend | UOM |
|----------------|-----------|---------|----------|----------|----------|--------|-----|
| 1046930 | 40-25 | 81 | 38 | 30 | 13 | 5 | tk |
| 1046931 | 40-32 | 81 | 38 | 30 | 13 | 5 | tk |
| 1046933 | 50-32 | 81 | 38 | 30 | 13 | 3 | tk |
| 1046934 | 50-40 | 89 | 38 | 38 | 14 | 3 | tk |

Uponor S-Press PLUS kolmik

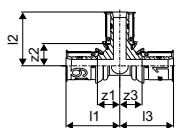

NEW
NEW
NEW
NEW

| Art. nr. | Dimension | l1 mm | l2 mm | l3 mm | z1 mm | z2 mm | z3 mm | 2. pak. | pakend | UOM |
|----------------|-----------|----------|----------|----------|----------|----------|----------|---------|--------|-----|
| 1070560 | 16-16-16 | 34 | 34 | 34 | 14 | 14 | 14 | 80 | 10 | tk |
| 1070561 | 20-20-20 | 37 | 37 | 37 | 16 | 16 | 16 | 40 | 10 | tk |
| 1070562 | 25-25-25 | 47 | 47 | 47 | 19 | 19 | 19 | 20 | 5 | tk |
| 1070563 | 32-32-32 | 51 | 51 | 51 | 23 | 23 | 23 | 20 | 5 | tk |

Uponor S-Press kolmik

- Tinatatud messing
- Värvkood

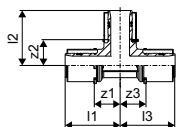

NEW
NEW

| Art. nr. | Dimension | l1 mm | l2 mm | l3 mm | z1 mm | z2 mm | z3 mm | pakend | UOM |
|----------------|-----------|----------|----------|----------|----------|----------|----------|--------|-----|
| 1046921 | 40-40-40 | 72 | 72 | 72 | 34 | 34 | 34 | 5 | tk |
| 1046928 | 50-50-50 | 79 | 79 | 79 | 41 | 41 | 41 | 3 | tk |

Uponor S-Press PLUS

Uponor S-Press PLUS erikolmik

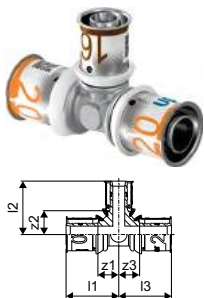

| Art. nr. | Dimension | l1 mm | l2 mm | l3 mm | z1 mm | z2 mm | z3 mm | 2. pak. | pakend | UOM |
|--------------------|-----------|----------|----------|----------|----------|----------|----------|---------|--------|-----|
| NEW 1070566 | 16-20-16 | 36 | 37 | 36 | 16 | 16 | 16 | 80 | 10 | tk |
| NEW 1070567 | 20-16-16 | 35 | 36 | 34 | 14 | 16 | 14 | 40 | 10 | tk |
| NEW 1070568 | 20-16-20 | 35 | 36 | 35 | 14 | 16 | 14 | 80 | 20 | tk |
| NEW 1070569 | 20-20-16 | 37 | 37 | 36 | 16 | 16 | 16 | 80 | 20 | tk |
| NEW 1070570 | 20-25-16 | 40 | 47 | 38 | 19 | 19 | 19 | 40 | 10 | tk |
| NEW 1070571 | 20-25-20 | 40 | 47 | 40 | 19 | 19 | 19 | 40 | 10 | tk |
| NEW 1070572 | 25-16-16 | 44 | 38 | 36 | 16 | 19 | 17 | 40 | 5 | tk |
| NEW 1070573 | 25-16-20 | 44 | 38 | 38 | 16 | 19 | 17 | 40 | 5 | tk |
| NEW 1070574 | 25-16-25 | 42 | 38 | 42 | 14 | 19 | 14 | 20 | 5 | tk |
| NEW 1070575 | 25-20-16 | 44 | 40 | 36 | 16 | 19 | 17 | 40 | 5 | tk |
| NEW 1070576 | 25-20-20 | 44 | 40 | 38 | 16 | 19 | 17 | 40 | 5 | tk |
| NEW 1070577 | 25-20-25 | 44 | 40 | 44 | 16 | 19 | 16 | 20 | 5 | tk |
| NEW 1070578 | 25-25-16 | 47 | 47 | 38 | 19 | 19 | 19 | 20 | 5 | tk |
| NEW 1070579 | 25-32-25 | 50 | 48 | 50 | 22 | 20 | 22 | 20 | 5 | tk |
| NEW 1070580 | 32-16-32 | 43 | 42 | 43 | 15 | 22 | 15 | 20 | 5 | tk |
| NEW 1070581 | 32-20-32 | 45 | 43 | 45 | 17 | 22 | 17 | 20 | 5 | tk |
| NEW 1070582 | 32-25-25 | 48 | 50 | 48 | 20 | 22 | 20 | 20 | 5 | tk |
| NEW 1070583 | 32-25-32 | 48 | 50 | 48 | 20 | 22 | 20 | 20 | 5 | tk |

Uponor S-Press erikolmik

- Tinatatud messing
- Värvkood

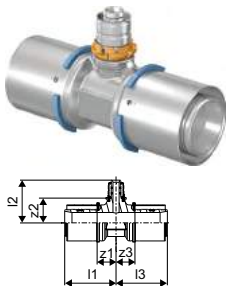

| Art. nr. | Dimension | l1 mm | l2 mm | l3 mm | z1 mm | z2 mm | z3 mm | pakend | UOM |
|--------------------|-----------|----------|----------|----------|----------|----------|----------|--------|-----|
| NEW 1046916 | 40-20-40 | 60 | 50 | 60 | 22 | 28 | 22 | 5 | tk |
| NEW 1046917 | 40-25-32 | 61 | 60 | 53 | 23 | 30 | 23 | 5 | tk |
| NEW 1046918 | 40-25-40 | 61 | 60 | 61 | 23 | 30 | 23 | 5 | tk |
| NEW 1046919 | 40-32-32 | 65 | 60 | 57 | 27 | 30 | 26 | 5 | tk |
| NEW 1046920 | 40-32-40 | 65 | 60 | 65 | 27 | 30 | 27 | 5 | tk |
| NEW 1046924 | 50-25-40 | 61 | 65 | 61 | 23 | 35 | 23 | 3 | tk |
| NEW 1046925 | 50-25-50 | 61 | 65 | 61 | 23 | 35 | 23 | 3 | tk |
| NEW 1046926 | 50-32-50 | 65 | 65 | 65 | 27 | 35 | 27 | 3 | tk |
| NEW 1046927 | 50-40-50 | 72 | 79 | 72 | 34 | 41 | 34 | 3 | tk |

Uponor S-Press PLUS kolmik väliskeere

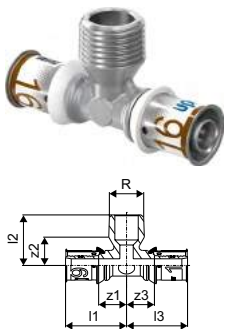

| Art. nr. | Dimension | l1 mm | l2 mm | l3 mm | R " | z1 mm | z2 mm | z3 mm | 2. pak. | pakend | UOM |
|--------------------|---------------|----------|----------|----------|--------|----------|----------|----------|---------|--------|-----|
| NEW 1070592 | 16-R1/2"MT-16 | 38 | 30 | 38 | 1/2 | 18 | 15 | 18 | 40 | 10 | tk |
| NEW 1070593 | 25-R3/4"MT-25 | 48 | 36 | 48 | 3/4 | 19 | 21 | 19 | 20 | 5 | tk |
| NEW 1070594 | 32-R3/4"MT-32 | 48 | 40 | 48 | 3/4 | 19 | 25 | 19 | 20 | 5 | tk |

Uponor S-Press PLUS

Uponor S-Press PLUS kolmik sisekeere

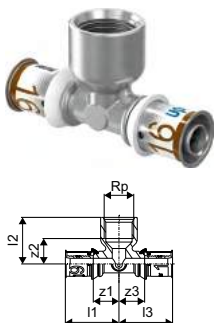

NEW
NEW
NEW
NEW
NEW
NEW
NEW

| Art. nr. | Dimension | l1 mm | l2 mm | l3 mm | Rp " | z1 mm | z2 mm | z3 mm | 2. pak. | pakend | UOM |
|----------|----------------|----------|----------|----------|---------|----------|----------|----------|---------|--------|-----|
| 1070595 | 16-Rp1/2"FT-16 | 38 | 33 | 38 | 1/2 | 18 | 18 | 18 | 40 | 10 | tk |
| 1070596 | 20-Rp1/2"FT-20 | 40 | 35 | 40 | 1/2 | 19 | 20 | 19 | 60 | 15 | tk |
| 1070597 | 20-Rp3/4"FT-20 | 43 | 37 | 43 | 3/4 | 22 | 20 | 22 | 40 | 10 | tk |
| 1070598 | 25-Rp1/2"FT-25 | 48 | 37 | 48 | 1/2 | 19 | 22 | 19 | 20 | 5 | tk |
| 1070599 | 25-Rp3/4"FT-25 | 50 | 40 | 50 | 3/4 | 22 | 23 | 22 | 20 | 5 | tk |
| 1070600 | 32-Rp1/2"FT-32 | 47 | 40 | 47 | 1/2 | 18 | 25 | 18 | 20 | 5 | tk |
| 1070601 | 32-Rp3/4"FT-32 | 51 | 44 | 51 | 3/4 | 23 | 27 | 23 | 20 | 5 | tk |

Uponor S-Press kolmik sisekeere

- Tinatatud messing
- Värvkood

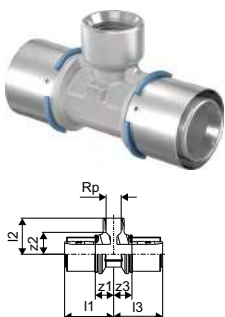

NEW
NEW

| Art. nr. | Dimension | l1 mm | l2 mm | l3 mm | Rp " | z1 mm | z2 mm | z3 mm | pakend | UOM |
|----------|----------------|----------|----------|----------|---------|----------|----------|----------|--------|-----|
| 1046923 | 40-Rp3/4"FT-40 | 64 | 47 | 64 | 3/4 | 26 | 31 | 26 | 5 | tk |
| 1046929 | 50-Rp1"FT-50 | 72 | 56 | 72 | 1 | 34 | 37 | 34 | 3 | tk |

Uponor S-Press PLUS otsik pöördmutriga

- Lahtivõetav keermesliitmik seinale kinnitatavate liitmike, filtrite ja sulgventiilide ühendamiseks
- Keere vastavalt EN ISO 228-1.

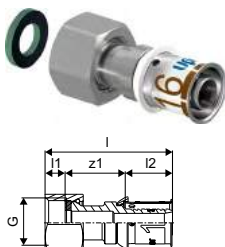

NEW
NEW
NEW
NEW
NEW
NEW
NEW
NEW
NEW
NEW

| Art. nr. | Dimension | l mm | l1 mm | l2 mm | G " | z1 mm | 2. pak. | pakend | UOM |
|----------|--------------|---------|----------|----------|--------|----------|---------|--------|-----|
| 1070602 | 16-G1/2"SN | 53 | 8 | 20 | 1/2 | 25 | 30 | 1 | tk |
| 1070603 | 16-G3/4"SN | 44 | 8 | 20 | 3/4 | 17 | 20 | 1 | tk |
| 1070604 | 20-G1/2"SN | 59 | 8 | 21 | 1/2 | 30 | 20 | 1 | tk |
| 1070605 | 20-G3/4"SN | 46 | 8 | 21 | 3/4 | 17 | 20 | 1 | tk |
| 1070606 | 25-G3/4"SN | 64 | 8 | 28 | 3/4 | 28 | 15 | 1 | tk |
| 1070607 | 25-G1"SN | 57 | 9 | 28 | 1 | 20 | 15 | 1 | tk |
| 1070608 | 25-G1 1/4"SN | 60 | 10 | 28 | 1 1/4 | 22 | 10 | 1 | tk |
| 1070609 | 32-G1"SN | 65 | 8 | 28 | 1 | 29 | 10 | 1 | tk |
| 1070610 | 32-G1 1/4"SN | 59 | 9 | 28 | 1 1/4 | 22 | 10 | 1 | tk |

Uponor S-Press PLUS

Uponor S-Press PLUS põlv pöördmutriga

- Lahtivõetav keermesliitmik seinale kinnitatavate liitmike, filtrite ja sulgventiilide ühendamiseks
- Keere vastavalt EN ISO 228-1.

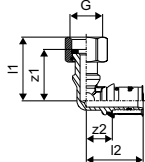

| Art. nr. | Dimension | l1 mm | l2 mm | G " | z1 mm | z2 mm | 2. pak. | pakend | UOM |
|----------------|------------|----------|----------|--------|----------|----------|---------|--------|-----|
| 1070612 | 16-G1/2"SN | 41 | 37 | 1/2 | 33 | 17 | 20 | 1 | tk |
| 1070613 | 20-G1/2"SN | 46 | 41 | 1/2 | 39 | 19 | 20 | 1 | tk |
| 1070614 | 25-G3/4"SN | 39 | 48 | 3/4 | 39 | 19 | 10 | 1 | tk |

Uponor S-Press PLUS kraanipõlv

- paigaldamiseks seinale või fiksaatorite abil Uponor Smart Aqua paigaldusplaadile.

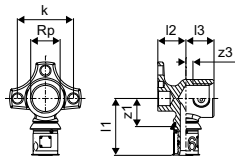

| Art. nr. | Dimension | l1 mm | l2 mm | l3 mm | Rp " | z1 mm | z3 mm | k mm | 2. pak. | pakend | UOM |
|----------------|-------------|----------|----------|----------|---------|----------|----------|---------|---------|--------|-----|
| 1070639 | 16-Rp1/2"FT | 41 | 20 | 20 | 1/2 | 21 | 5 | 40 | 40 | 10 | tk |
| 1070640 | 20-Rp1/2"FT | 44 | 20 | 21 | 1/2 | 23 | 6 | 40 | 40 | 10 | tk |
| 1070641 | 20-Rp3/4"FT | 45 | 20 | 23 | 3/4 | 24 | 7 | 40 | 20 | 5 | tk |
| 1070642 | 25-Rp3/4"FT | 54 | 27 | 25 | 3/4 | 26 | 8 | 40 | 20 | 5 | tk |

Uponor S-Press PLUS kraanipõlv pikk

- paigaldamiseks seinale või fiksaatorite abil Uponor Smart Aqua paigaldusplaadile.

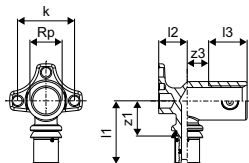

| Art. nr. | Dimension | l1 mm | l2 mm | l3 mm | Rp " | z1 mm | z3 mm | k mm | 2. pak. | pakend | UOM |
|----------------|-------------|----------|----------|----------|---------|----------|----------|---------|---------|--------|-----|
| 1070644 | 16-Rp1/2"FT | 42 | 20 | 30 | 1/2 | 22 | 15 | 40 | 40 | 10 | tk |
| 1070645 | 20-Rp1/2"FT | 46 | 20 | 30 | 1/2 | 25 | 15 | 40 | 40 | 10 | tk |

Uponor S-Press PLUS

Uponor S-Press PLUS kattega kraanipölv

- seinapealseks paigalduseks. Ventili ja kattega



NEW

| Art. nr. | Dimension | l | l1 | l2 | Rp2 | R2 | z1 | z2 | 2. pak. | pakend UOM |
|----------------|-------------|----|----|----|------|------|----|----|---------|------------|
| | | mm | mm | mm | mm | mm | mm | mm | | |
| 1070643 | 16-Rp3/4"FT | 47 | 31 | 47 | 1/2" | 3/4" | 22 | 27 | 20 | 1 tk |

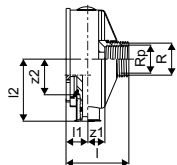

Uponor S-Press PLUS U-kraanipölv

- paigaldamiseks seinale või fiksaatorite abil Uponor Smart Aqua paigaldusplaadile.



NEW

NEW

NEW

NEW

NEW

NEW

NEW

| Art. nr. | Dimension | l1 | l2 | l3 | l4 | Rp | z1 | z2 | z4 | b | k | 2. pak. | pakend UOM |
|----------------|----------------|----|----|----|----|-----|----|----|----|----|----|---------|------------|
| | | mm | mm | mm | mm | mm | mm | mm | mm | mm | mm | | |
| 1070629 | 16-Rp1/2"FT-16 | 56 | 56 | 20 | 23 | 1/2 | 36 | 36 | 8 | 45 | 40 | 20 | 5 tk |
| 1070630 | 20-Rp1/2"FT-20 | 57 | 57 | 20 | 23 | 1/2 | 36 | 36 | 8 | 45 | 40 | | 5 tk |
| 1070631 | 20-Rp1/2"FT-16 | 57 | 56 | 20 | 23 | 1/2 | 36 | 36 | 8 | 45 | 40 | | 5 tk |
| 1070632 | 16-Rp1/2"FT-20 | 56 | 57 | 20 | 23 | 1/2 | 36 | 36 | 8 | 45 | 40 | | 5 tk |
| 1070633 | 25-Rp1/2"FT-25 | 64 | 64 | 27 | 24 | 1/2 | 36 | 36 | 9 | 60 | 40 | | 3 tk |
| 1070634 | 25-Rp1/2"FT-20 | 64 | 57 | 27 | 24 | 1/2 | 36 | 36 | 9 | 60 | 40 | | 3 tk |
| 1070635 | 20-Rp1/2"FT-25 | 57 | 64 | 27 | 24 | 1/2 | 36 | 36 | 9 | 60 | 40 | | 3 tk |

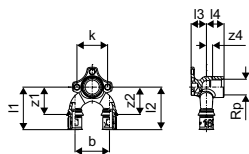

Uponor S-Press PLUS U-segisti kraanipölv

- seinasiseste segistite või loputuskastide ühendamiseks järjestikusel- või ringpaigaldusel.



NEW

NEW

| Art. nr. | Dimension | l1 | l2 | R | z1 | z2 | b | pakend UOM |
|----------------|---------------|----|----|-----|----|----|----|------------|
| | | mm | mm | mm | mm | mm | mm | |
| 1070636 | 16-16-R1/2"MT | 57 | 60 | 1/2 | 42 | 40 | 45 | 5 tk |
| 1070637 | 20-20-R3/4"MT | 61 | 62 | 3/4 | 42 | 40 | 45 | 5 tk |

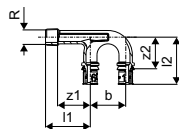

Uponor S-Press PLUS

Uponor S-Press PLUS kork



| Art. nr. | Dimension | l mm | l1 mm | l2 mm | 2. pak. | pakend | UOM |
|----------------|-----------|---------|----------|----------|---------|--------|-----|
| 1070621 | 16 | 27 | 7 | 20 | 160 | 20 | tk |
| 1070622 | 20 | 28 | 7 | 21 | | 10 | tk |
| 1070623 | 25 | 35 | 7 | 28 | | 10 | tk |
| 1070624 | 32 | 35 | 7 | 28 | | 5 | tk |

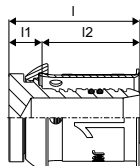

Uponor MLC survestusotsik

- Taaskasutatav otsik Uponor komposiitorude surveprooviks, kruvitakse faasitud toru sisse
- Peale surveproovi lõppu keerake otsik torust välja ja lõigake toru pikkus sobivaks (otsiku pikkus + 1,5 mm).



| Art. nr. | Dimension | l mm | l1 mm | l2 mm | G " | z1 mm | pakend | UOM |
|----------------|-----------|---------|----------|----------|--------|----------|--------|-----|
| 1013756 | 16 | 52 | 14 | 30 | 1/2 | 8 | 10 | tk |
| 1013760 | 20 | 52 | 14 | 30 | 1/2 | 8 | 10 | tk |
| 1013762 | 25 | 57 | 14 | 35 | 1/2 | 8 | 10 | tk |
| 1013764 | 32 | 64 | 14 | 42 | 1/2 | 8 | 5 | tk |
| 1013765 | 40 | 67 | 14 | 45 | 1/2 | 8 | 2 | tk |

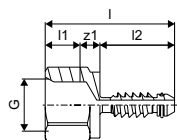

Uponor S-Press PLUS kraanipõlve komplekt



| Art. nr. | Dimension | l mm | Rp " | b mm | h mm | h1 mm | k mm | 2. pak. | pakend | UOM |
|----------------|----------------------|---------|---------|---------|---------|----------|---------|---------|--------|-----|
| 1070666 | 16-Rp1/2"FT c/c150mm | 390 | 1/2 | 266 | 54 | 46 | 150 | 175 | 5 | tk |

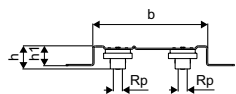
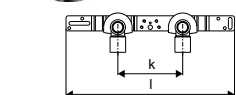

Uponor S-Press PLUS kraanipõlve komplekt



| Art. nr. | Dimension | l mm | Rp " | b mm | h mm | h1 mm | k mm | 2. pak. | pakend | UOM |
|----------------|----------------------|---------|---------|---------|---------|----------|---------|---------|--------|-----|
| 1070661 | 16-Rp1/2"FT c/c80mm | 320 | 1/2 | 196 | 49 | 46 | 80 | | 5 | tk |
| 1070662 | 16-Rp1/2"FT c/c150mm | 390 | 1/2 | 266 | 49 | 46 | 150 | 175 | 5 | tk |

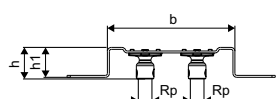
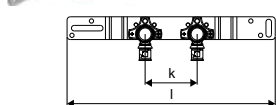

Uponor S-Press PLUS

Uponor S-Press PLUS ühenduspölv

- Tinatatud messing
- vasktoruga 15 x 1 mm, pinnakattega.
- Vasktoru 15 x 1 mm ühendamiseks radiaatoriga kasutada Uponor surveliitmikku Cu (Art. Nr. 1013830).

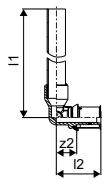

NEW

| Art. nr. | Dimension | l1 mm | l2 mm | z2 mm | pakend | UOM |
|----------------|-----------------|----------|----------|----------|--------|-----|
| 1070651 | 16-12CU l=150mm | 166 | 37 | 17 | 20 | tk |

Uponor S-Press siirdmik sulventiiliga vasktorule. DR messing

- Tinatatud DR-messing
- Pressitav ilma kalibreerimiseta
- Värvkood
- Lekkeindikatsioon
- Komplektis kuulkraan
- Surveliidmik CU 10.



NEW

| Art. nr. | Dimension | d mm | AG " | pakend | UOM |
|----------------|-----------|---------|---------|--------|-----|
| 1007510 | 16-10CU | 16 | 3/8 | 10 | tk |

Uponor S-Press PLUS seinä läbiv otsik

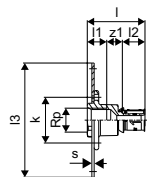

NEW

| Art. nr. | Dimension | l mm | l1 mm | l2 mm | l3 mm | s mm | Rp " | z1 mm | k mm | 2. pak. | pakend | UOM |
|----------------|------------|---------|----------|----------|----------|---------|---------|----------|---------|---------|--------|-----|
| 1070652 | 16-G1/2"FT | 51 | 17 | 20 | 100 | 2,0 | 1/2 | 14 | 40 | 5 | 1 | tk |

Uponor S-Press PLUS

Uponor Smart Aqua kraanipõlve paigaldusplaat

- Galvaniseeritud teras.
- Uponor Smart Aqua kraanipõlvede paigaldamiseks
- Positsioneerimine vastavalt eeltöödeldud avadele
- Komplektis plasttihvtid ja kruvid vastavalt DIN 965
- Kinnitusavad täpseks paigalduseks



NEW

| Art. nr. | Dimension | l mm | s mm | h mm | k mm | k1 mm | w mm | 2. pak. | pakend | UOM |
|----------------|-----------|---------|---------|---------|---------|----------|---------|---------|--------|-----|
| 1057840 | 75/150mm | 265 | 3,0 | 9 | 75 | 150 | 35 | 5 | 1 | tk |

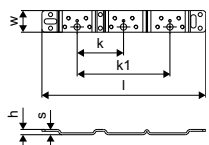

Uponor Smart Aqua kraanipõlve paigaldusplaat

- Galvaniseeritud teras.
- Uponor Smart Aqua kraanipõlvede paigaldamiseks
- Positsioneerimine vastavalt eeltöödeldud avadele
- Komplektis plasttihvtid ja kruvid vastavalt DIN 965
- Kinnitusavad täpseks paigalduseks



NEW

| Art. nr. | Dimension | l mm | s mm | b mm | h mm | k mm | k1 mm | w mm | 2. pak. | pakend | UOM |
|----------------|-----------|---------|---------|---------|---------|---------|----------|---------|---------|--------|-----|
| 1057842 | 75/150mm | 390 | 3 | 266 | 46 | 75 | 150 | 35 | 165 | 5 | tk |

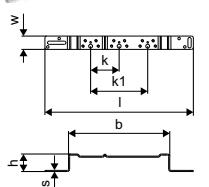

Uponor Smart Aqua kraanipõlve paigaldusnurk

- Galvaniseeritud teras.
- Uponor Smart Aqua kraanipõlvede paigaldamiseks
- Positsioneerimine vastavalt eeltöödeldud avadele
- Komplektis plasttihvtid ja kruvid vastavalt DIN 965
- Kinnitusavad täpseks paigalduseks



NEW

| Art. nr. | l mm | b mm | h mm | 2. pak. | pakend | UOM |
|----------------|---------|---------|---------|---------|--------|-----|
| 1057843 | 144 | 82 | 46 | 5 | 1 | tk |

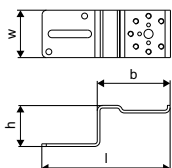

Uponor S-Press PLUS

Uponor Smart Aqua kraanipõlve paigalduslatt 2m

- Galvaniseeritud teras.
- Uponor Smart Aqua kraanipõlvede paigaldamiseks
- Positsioneerimine vastavalt eeltöödeldud avadele
- Komplektis plastihvtid ja kruvid vastavalt DIN 965
- Kinnitusavad täpseks paigalduseks



NEW

| Art. nr. | Dimension | l mm | k mm | 2. pak. | pakend | UOM |
|----------------|-----------|---------|---------|---------|--------|-----|
| 1057844 | 2m | 2000 | 75 | 10 | 1 | tk |

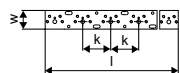

Uponor S-Press PLUS siirdmik

- Joodetud vasktoruga vastavalt EN 1057 (poolkõva / R250)
- üleni tinatatud
- Tähelepanu:

vasktoru ots ainult pressliitmikele või sobivatele surveleitmikele.

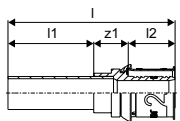

NEW

NEW

NEW

NEW

NEW

NEW

NEW

NEW

NEW

| Art. nr. | Dimension | l mm | l1 mm | l2 mm | z1 mm | 2. pak. | pakend | UOM |
|----------------|-----------|---------|----------|----------|----------|---------|--------|-----|
| 1070705 | 16-10CU | 66 | 30 | 20 | 16 | 80 | 10 | tk |
| 1070706 | 16-12CU | 66 | 30 | 20 | 16 | 80 | 10 | tk |
| 1070615 | 16-15CU | 76 | 40 | 20 | 16 | 160 | 20 | tk |
| 1070707 | 20-15CU | 76 | 39 | 21 | 16 | | 10 | tk |
| 1070616 | 20-18CU | 78 | 40 | 21 | 17 | 40 | 10 | tk |
| 1070617 | 20-22CU | 81 | 41 | 21 | 19 | 60 | 15 | tk |
| 1070618 | 25-22CU | 88 | 41 | 28 | 19 | 20 | 5 | tk |
| 1070619 | 25-28CU | 92 | 43 | 28 | 21 | | 5 | tk |
| 1070620 | 32-28CU | 92 | 43 | 28 | 21 | 20 | 5 | tk |

Uponor S-Press PLUS radiatori ühenduspõlv pinnakattega

- pinnakattega messing
- vasktoru 15 x 1 mm, pinnakattega.
- Vasktoru 15 x 1 mm ühendamiseks radiatoriga kasutada Uponor vase surveleitmikku (art.nr. 1013830).

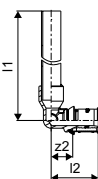

NEW

NEW

| Art. nr. | Dimension | l1 mm | l2 mm | z1 mm | pakend | UOM |
|----------------|-----------------|----------|----------|----------|--------|-------|
| 1070678 | 16-15CU l=350mm | 366 | 37 | 17 | 20 | tk |
| 1070680 | 25-22CU l=250mm | 250 | 48 | 19 | 640 | 20 tk |

Uponor S-Press PLUS

Uponor S-Press PLUS radiaatori ühenduskolmik pinnakattega

- Tinatatud messing
- Painutatud vasktoru 15 x 1 mm, pinnakattega
- Vasktoru 15 x 1 mm ühendamiseks radiaatoriga kasutada Uponor vase surveliitmikku (art.nr. 1013830)

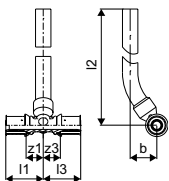

| Art. nr. | Dimension | l1 mm | l2 mm | l3 mm | z1 mm | z3 mm | b mm | 2. pak. | pakend | UOM |
|----------------|--------------------|----------|----------|----------|----------|----------|---------|---------|--------|-----|
| 1070681 | 16-15CU-16 l=350mm | 38 | 351 | 38 | 18 | 18 | 26 | 600 | 20 | tk |
| 1070682 | 20-15CU-20 l=350mm | 40 | 353 | 40 | 19 | 19 | 27 | 600 | 20 | tk |

Uponor Smart Radi katteplaat valge



| Art. nr. | Dimension | d mm | l mm | l1 mm | pakend | UOM |
|-----------------|-----------|---------|---------|----------|--------|-----|
| 1011370 | 16 white | 16 | 47 | 15 | 50 | tk |
| 1011372* | 20 white | 20 | 48 | 14 | 50 | tk |

Uponor Smart Radi kaksik katteplaat

- Polüpropüleen, valge
- Uponor Uni Pipe PLUS ja MLC torude 14 - 20 mm põranda või seinä läbiviikude katmiseks radiaatorküttesüsteemis
- Toru telgede vahe 50 mm
- Kaheosaline, ühendatakse kahe lukusti abil
- Tulepüsivuse klass B2 vast. EN 13501-1.

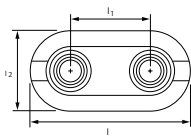

| Art. nr. | Dimension | d mm | l mm | l1 mm | l2 mm | 2. pak. | pakend | UOM |
|----------------|--------------------|---------|---------|----------|----------|---------|--------|-----|
| 1011373 | 14-20 white double | 14-20 | 100 | 50 | 50 | 500 | 50 | tk |

Uponor RS

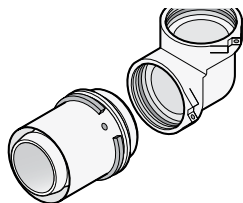

Uponor RS on unikaalne moodulsüsteem püstakute ja magistraalitorustike ehitamiseks. 40 komponendist süsteem võimaldab koostada sadu erinevaid variatsioone.

Eelised

- Unikaalne ühendus korpuse ja adapterite vahel
- Kiire ja paindlik: tööriistavaba ühendus, palju variante
- Muutmise võimalus paigalduse käigus
- Värvkoodid läbimõõtetel 16 -110mm



Kirjeldus

- fikseeritud presshülsiga
- stoppervõru
- värvkood
- lekkeindikaator

Kasutusala

- Tarbevesi: püsiv töötemperatuur 0°C kuni 70°C maksimaalsel püsival tööõhul 10 bar. Lühiajaline avariitemperatuur 95°C 100 tundi kasutusaja jooksul.
- Küte: püsiv töötemperatuur kuni 80°C maksimaalsel püsival tööõhul 10 bar. Lühiajaline avariitemperatuur 100°C 100 tundi kasutusaja jooksul.
- Kui ei ole teisiti nimetatud: välis- ja sisekeermed vast. EN 10226-1.

Sertifitseerimine

- DVGW
- AENOR

Uponor RS jätk

- Tinatatud messing
- Baasdetail kõikidele RS2 või RS3 siirdmikele, komplektis 2 lukustit.



| Art. nr. | Dimension | l mm | pakend UOM | |
|----------------|-----------|---------|------------|----|
| 1029144 | RS2-RS2 | 58 | 1 | tk |
| 1029145 | RS3-RS3 | 58 | 1 | tk |

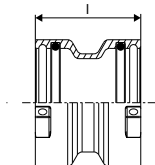

Uponor RS põlv

- Tinatatud messing
- Baasdetail kõikidele RS2 või RS3 siirdmikele, komplektis 2 lukustit.



| Art. nr. | Dimension | l1 mm | l2 mm | pakend UOM | |
|----------------|-----------|----------|----------|------------|----|
| 1029138 | RS2-RS2 | 51 | 51 | 1 | tk |
| 1029139 | RS3-RS3 | 68 | 68 | 1 | tk |

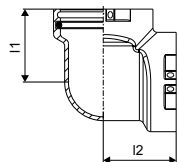

Uponor RS

Uponor RS põlv 45°

- Tinatatud messing
- Baasdetail kõikidele RS2 või RS3 siirdmikele, komplektis 2 lukustit.

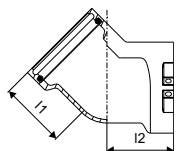

| Art. nr. | Dimension | l1 mm | l2 mm | pakend | UOM |
|----------------|-----------|----------|----------|--------|-----|
| 1029140 | RS2-RS2 | 51 | 51 | 1 | tk |
| 1029141 | RS3-RS3 | 68 | 68 | 1 | tk |

Uponor RS kolmik

- Tinatatud messing
- Baasdetail kõikidele RS2 või RS3 siirdmikele, komplektis 3 lukustit.

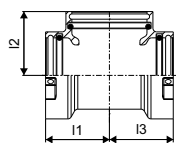

| Art. nr. | Dimension | l1 mm | l2 mm | l3 mm | pakend | UOM |
|----------------|-------------|----------|----------|----------|--------|-----|
| 1029142 | RS2-RS2-RS2 | 51 | 51 | 51 | 1 | tk |
| 1029143 | RS3-RS3-RS3 | 68 | 68 | 68 | 1 | tk |

Uponor RS üleminek

- Tinatatud messing
- Baasdetail kõikidele RS2 või RS3 siirdmikele, komplektis 1 lukusti.

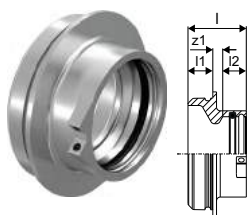

| Art. nr. | Dimension | l mm | l1 mm | l2 mm | z1 mm | pakend | UOM |
|----------------|-----------|---------|----------|----------|----------|--------|-----|
| 1029146 | RS3-RS2 | 47 | 20 | 19 | 8 | 1 | tk |

Uponor RS vahetükk

- Tinatatud messing
- Vahetükk samas mõõdus RS baasdetailide ühendamiseks.

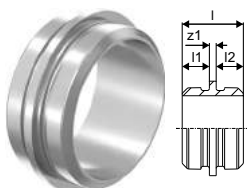

| Art. nr. | Dimension | l mm | l1 mm | l2 mm | z1 mm | pakend | UOM |
|-----------------|---------------|---------|----------|----------|----------|--------|-----|
| 1046750 | RS2-RS2 l=5mm | 45 | 20 | 20 | 5 | 1 | tk |
| 1046751* | RS3-RS3 l=5mm | 45 | 20 | 20 | 5 | 1 | tk |

Uponor RS

Uponor RS vahetükk

- Tinatatud messing
- Vahetükk samas moodsus RS baasdetailide ühendamiseks, näiteks kolmikute kollektorite koostamiseks või jaotustorustikest üleminekutes.

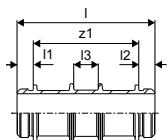

| Art. nr. | Dimension | l mm | l1 mm | l2 mm | l3 mm | z1 mm | | pakend | UOM |
|-----------------|-----------------|---------|----------|----------|----------|----------|--|--------|-----|
| 1046477* | RS2-RS2 l=130mm | 170 | 20 | 20 | 30 | 130 | | 1 | tk |
| 1046478* | RS3-RS3 l=210mm | 250 | 20 | 20 | 30 | 210 | | 1 | tk |

Uponor RS siirdmik S-Press

- Tinatatud messing
- Ühildub kõikide RS2 baasdetailidega.

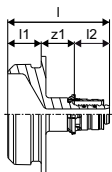

| Art. nr. | Dimension | l mm | l1 mm | l2 mm | z1 mm | | pakend | UOM |
|----------------|-----------|---------|----------|----------|----------|--|--------|-----|
| 1059397 | 16-RS2 | 61 | 20 | 21 | 20 | | 1 | tk |
| 1059396 | 20-RS2 | 62 | 20 | 22 | 20 | | 1 | tk |
| 1029121 | 25-RS2 | 59 | 20 | 30 | 9 | | 1 | tk |
| 1029122 | 32-RS2 | 59 | 20 | 30 | 9 | | 1 | tk |

Uponor RS S-Press PLUS



| Art. nr. | Dimension | l mm | l1 mm | l2 mm | z1 mm | | pakend | UOM |
|----------------|-----------|---------|----------|----------|----------|--|--------|-----|
| 1095818 | 20-RS2 | NaN | NaN | NaN | NaN | | 1 | tk |
| 1095819 | 25-RS2 | 75 | 20 | 28 | 27 | | 1 | tk |
| 1095820 | 32-RS2 | 75 | 20 | 28 | 27 | | 1 | tk |

Uponor RS siirdmik S-Press

- Tinatatud messing
- Ühildub kõikide RS2 ja RS3 baasdetailidega.

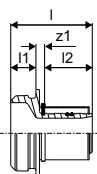
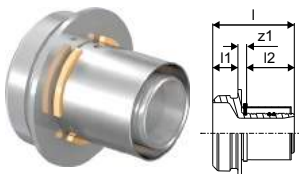

| Art. nr. | Dimension | l mm | l1 mm | l2 mm | z1 mm | | pakend | UOM |
|----------------|-----------|---------|----------|----------|----------|--|--------|-----|
| 1046940 | 40-RS2 | 65 | 20 | 38 | 7 | | 1 | tk |
| 1046941 | 50-RS2 | 65 | 20 | 38 | 7 | | 1 | tk |
| 1029125 | 63-RS2 | 88 | 20 | 61 | 7 | | 1 | tk |
| 1029126 | 75-RS2 | 88 | 20 | 61 | 7 | | 1 | tk |
| 1029127 | 90-RS3 | 93 | 20 | 62 | 11 | | 1 | tk |
| 1029128 | 110-RS3 | 93 | 20 | 62 | 11 | | 1 | tk |

Uponor RS

Uponor RS otsik väliskeere

- Tinatatud messing
- Ühildub kõikide RS2 ja RS3 baasdetailidega.

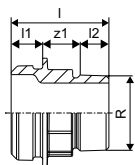

| Art. nr. | Dimension | l mm | l1 mm | l2 mm | R " | z1 mm | pakend | UOM |
|----------|---------------|---------|----------|----------|--------|----------|--------|-----|
| 1059402 | R1 1/2"MT-RS2 | 62 | 20 | 24 | 1 1/2 | 18 | 1 | tk |
| 1029131 | R2"MT-RS2 | 66 | 20 | 23 | 2 | 23 | 1 | tk |
| 1029132 | R2 1/2"MT-RS2 | 63 | 20 | 27 | 2 1/2 | 16 | 1 | tk |
| 1029133 | R3"MT-RS3 | 73 | 20 | 30 | 3 | 23 | 1 | tk |

Uponor RS otsik sisekeere

- Tinatatud messing
- Ühildub kõikide RS2 ja RS3 baasdetailidega.

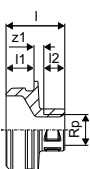

| Art. nr. | Dimension | l mm | l1 mm | l2 mm | Rp " | z1 mm | pakend | UOM |
|----------|----------------|---------|----------|----------|---------|----------|--------|-----|
| 1059403 | Rp1/2"FT-RS2 | 42 | 20 | 15 | 1/2 | 7 | 1 | tk |
| 1029134 | Rp1"FT-RS2 | 45 | 20 | 19 | 1 | 6 | 1 | tk |
| 1029135 | Rp2"FT-RS2 | 54 | 20 | 26 | 2 | 8 | 1 | tk |
| 1029136 | Rp2 1/2"FT-RS2 | 63 | 20 | 30 | 2 1/2 | 12 | 1 | tk |
| 1059404 | Rp1/2"FT-RS3 | 43 | 20 | 15 | 1/2 | 8 | 1 | tk |
| 1029137 | Rp3"FT-RS3 | 65 | 20 | 33 | 3 | 12 | 1 | tk |

Uponor RS äärik

- Tinatatud messing
- Ühildub kõikide RS2 või RS3 baasdetailidega
- Äärik PN6/PN16 vast. EN 1092-3
- 4/8 kinnituspoltide ava.

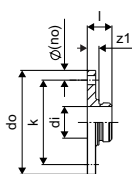

| Art. nr. | Dimension | l3 mm | di mm | do mm | z1 mm | k mm | p bar | pakend | UOM |
|----------|------------------|----------|----------|----------|----------|---------|----------|--------|------|
| 1059398 | RS2-DN65 (PN6) | 38 | 18 | 48,7 | 160 | 18 | 130 | 6 | 1 tk |
| 1059399* | RS2-DN65 (PN16) | 45 | 25 | 48,7 | 185 | 25 | 145 | 16 | 1 tk |
| 1059400 | RS3-DN80 (PN6) | 38 | 18 | 78,1 | 190 | 18 | 150 | 6 | 1 tk |
| 1029129* | RS3-DN80 (PN16) | 45 | 25 | 78,1 | 200 | 25 | 160 | 16 | 1 tk |
| 1059401 | RS3-DN100 (PN6) | 41 | 21 | 78,1 | 210 | 21 | 170 | 6 | 1 tk |
| 1029130 | RS3-DN100 (PN16) | 44 | 24 | 78,1 | 220 | 24 | 180 | 16 | 1 tk |

Uponor RS lukusti

- plastik
- RS siirdmike lukustamiseks RS baasdetailide külge.



| Art. nr. | Dimension | värvus | pakend | UOM |
|----------|-----------|-----------------|--------|-----|
| 1042921 | RS2 black | must | 10 | tk |
| 1042922 | RS3 grey | Hall (RAL 7015) | 10 | tk |

Uponor Uni-X

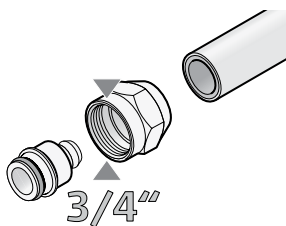

UNI-X roostevaba kollektor ja lai valik 3/4" eurokoonus ja muid tollmõõdus surveliitmike radiaatorküttele.

Eelised

- Universaalne kollektor
- Universaalsed surveliitmikud
- Lihtne sobitada muude torusüsteemidega



Kasutusala

- Küttevete jaotamiseks radiaatorküttesüsteemides

Uponor Uni-X kollektor H 1"SN

- Roostevabast terasest kollektor radiaatorküttele
- Pöördmutterühendus 1" sisekeere, komplektis lametihend
- Väljuvate otste samm 50 mm
- Kollektorite telgede vahe 200 mm

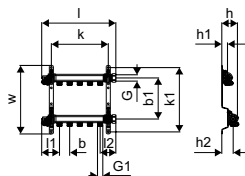

| Art. nr. | Dimension | l | l1 | l2 | G | G1 | b | b1 | b2 | h | h1 | h2 | k | k1 | w | väljundid | p | 2. pak. | pakend | UOM |
|----------|--------------|-----|----|----|---|-----|----|-----|-----|----|----|----|-----|-----|-----|-----------|-----|---------|--------|-----|
| | | mm | mm | mm | " | " | mm | mm | mm | mm | mm | mm | mm | mm | mm | - | bar | | | |
| 1088873 | 2xG3/4 Euro | 210 | 87 | 73 | 1 | 3/4 | 50 | 215 | 215 | 75 | 30 | 50 | 135 | 336 | 357 | 2 | 6 | | 1 | tk |
| 1088874 | 3xG3/4 EURO | 260 | 87 | 73 | 1 | 3/4 | 50 | 215 | 215 | 75 | 30 | 50 | 185 | 336 | 357 | 3 | 6 | | 1 | tk |
| 1088875 | 4xG3/4 EURO | 310 | 87 | 73 | 1 | 3/4 | 50 | 215 | 215 | 75 | 30 | 50 | 235 | 336 | 357 | 4 | 6 | | 1 | tk |
| 1088876 | 5xG3/4 EURO | 360 | 87 | 73 | 1 | 3/4 | 50 | 215 | 215 | 75 | 30 | 50 | 285 | 336 | 357 | 5 | 6 | | 1 | tk |
| 1088877 | 6xG3/4 EURO | 410 | 87 | 73 | 1 | 3/4 | 50 | 215 | 215 | 75 | 30 | 50 | 335 | 336 | 357 | 6 | 6 | | 1 | tk |
| 1088878 | 7xG3/4 EURO | 460 | 87 | 73 | 1 | 3/4 | 50 | 215 | 215 | 75 | 30 | 50 | 385 | 336 | 357 | 7 | 6 | | 1 | tk |
| 1088879 | 8xG3/4 EURO | 510 | 87 | 73 | 1 | 3/4 | 50 | 215 | 215 | 75 | 30 | 50 | 435 | 336 | 357 | 8 | 6 | | 1 | tk |
| 1088880 | 9xG3/4 EURO | 560 | 87 | 73 | 1 | 3/4 | 50 | 215 | 215 | 75 | 30 | 50 | 485 | 336 | 357 | 9 | 6 | | 1 | tk |
| 1088881 | 10xG3/4 EURO | 610 | 87 | 73 | 1 | 3/4 | 50 | 215 | 215 | 75 | 30 | 50 | 535 | 336 | 357 | 10 | 6 | 48 | 1 | tk |
| 1088882 | 11xG3/4 EURO | 660 | 87 | 73 | 1 | 3/4 | 50 | 215 | 215 | 75 | 30 | 50 | 585 | 336 | 357 | 11 | 6 | 48 | 1 | tk |
| 1088883 | 12xG3/4 EURO | 710 | 87 | 73 | 1 | 3/4 | 50 | 215 | 215 | 75 | 30 | 50 | 635 | 336 | 357 | 12 | 6 | 48 | 1 | tk |

Uponor Uni-X

Uponor Uni-X surveliitmik MLC

- Messingist surveliitmik
- Uponor Uni Pipe PLUS ja MLC torude ühendamiseks kollektoriga Uni X
- Sisekeere 3/4" eurokoonus, vast. EN ISO 228-1.

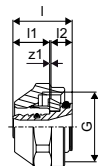

| Art. nr. | Dimension | l | l1 | G | z1 | 2. pak. | pakend | UOM |
|----------------|----------------|----|----|-----|----|---------|--------|-----|
| | | mm | mm | " | mm | | | |
| 1058090 | 16-3/4"FT Euro | 23 | 13 | 3/4 | 3 | 25 | 1 | tk |
| 1058092 | 20-3/4"FT Euro | 24 | 14 | 3/4 | 3 | 25 | 1 | tk |
| 1058093 | 25-3/4"FT Euro | 27 | 14 | 3/4 | 7 | 25 | 1 | tk |

Uponor Uni-X nippel pinnakattega

- Tinatatud messing
- Väliskeere vast. to EN ISO 228-1.

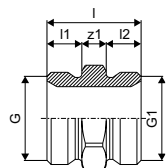

| Art. nr. | Dimension | l | l1 | l2 | G | G1 | z1 | 2. pak. | pakend | UOM |
|----------------|---------------------------|----|----|----|-----|-----|----|---------|--------|-----|
| | | mm | mm | mm | " | " | mm | | | |
| 1006641 | G3/4"MT Euro-G3/4"MT Euro | 27 | 10 | 10 | 3/4 | 3/4 | 7 | 80 | 10 | tk |

Uponor Uni-C

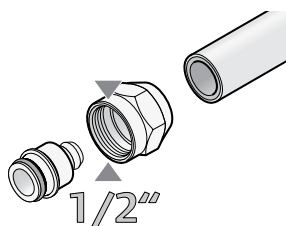

Messingkollektor koos laia valiku 1/2" keermega surveliitmikega

Eelised

- Messingkollektor
- Messingist surveliitmikud
- Lihtne sobitada muude torusüsteemidega
- Paindlik süsteem



Uponor Uni-C kollektor S

- Tinatatud messing
- Otsad 1" VK/SK. Väljundid 1/2" VK Ühendamiseks Uponor surveliitmikega.

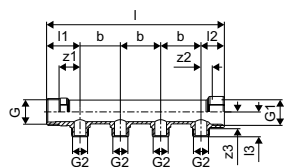

| Art. nr. | Dimension | l | l1 | l2 | l3 | G | G1 | G2 | z1 | z2 | z3 | b | väljundid | pakend | UOM |
|-----------------|------------------|-----|----|----|----|---|----|-----|----|----|----|----|-----------|--------|-----|
| | | mm | mm | mm | mm | " | " | " | mm | mm | mm | mm | - | | |
| 1014107* | 1"MT/FT 2X1/2"MT | 121 | 42 | 29 | 31 | 1 | 1 | 1/2 | 26 | 14 | 21 | 50 | 2 | 1 | tk |
| 1014111* | 1"MT/FT 3X1/2"MT | 171 | 42 | 29 | 31 | 1 | 1 | 1/2 | 26 | 14 | 21 | 50 | 3 | 1 | tk |
| 1014109* | 1"MT/FT 4X1/2"MT | 220 | 42 | 29 | 31 | 1 | 1 | 1/2 | 26 | 14 | 21 | 50 | 4 | 1 | tk |

Uponor Uni-C kollektori otsakork S/SH PL

- Pinnakattega messing
- Komplektis tihend

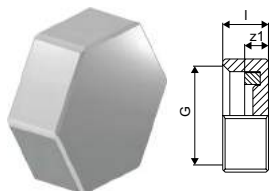

| Art. nr. | Dimension | l | G | z1 | 2. pak. | pakend | UOM |
|-----------------|-----------|----|----|----|---------|--------|-----|
| | | mm | mm | mm | | | |
| 1014121* | G1"FT | 12 | 1 | 4 | 120 | 20 | tk |

Uponor Uni-C surveliitmik MLC

- Messing surveliitmik
- Uponor Uni Pipe PLUS ja MLC torude ühendamiseks kollektoritega (näit. Uponor kollektor S, SH)
- Sisekeere 1/2" vastavalt EN ISO 228-1
- Ei vaja toru faasimist.



| Art. nr. | Dimension | l | l1 | G | z1 | 2. pak. | pakend | UOM |
|----------------|-----------|----|----|-----|----|---------|--------|-----|
| | | mm | mm | " | mm | | | |
| 1058086 | 16-1/2"FT | 23 | 13 | 1/2 | 4 | 25 | 1 | tk |
| 1058088 | 20-1/2"FT | 26 | 14 | 1/2 | 7 | 25 | 1 | tk |

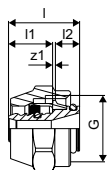

Uponor Uni-C

Uponor Uni-C nippel pinnakattega MLC

- Tinatatud messing
- Väliskeere vast. EN ISO 228-1.

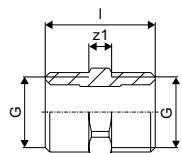

| Art. nr. | Dimension | l mm | G " | G1 " | z1 mm | 2. pak. | pakend | UOM |
|----------------|---------------|---------|--------|---------|----------|---------|--------|-----|
| 1013894 | 1/2"MT-1/2"MT | 29 | 1/2 | 1/2 | 6 | 160 | 20 | tk |

Uponor Uni-C põlv pinnakattega MLC

- Tinatatud messing
- Väliskeere vast. EN ISO 228-2.

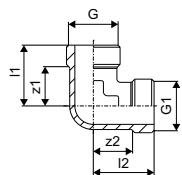

| Art. nr. | Dimension | l1 mm | l2 mm | G " | G1 " | z1 mm | z2 mm | 2. pak. | pakend | UOM |
|----------------|-----------------|----------|----------|--------|---------|----------|----------|---------|--------|-----|
| 1013914 | G1/2"MT-G1/2"MT | 29 | 29 | 1/2 | 1/2 | 18 | 18 | 80 | 10 | tk |

Uponor Aqua Pipe

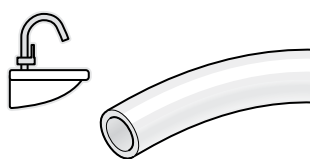

Uponor Aqua Pipe on valmistatud kõrgeima kvaliteediga ristseotud polüetüleenist kasutamiseks tarbevesüsteemides

Eelised

- Sertifitseeritud kvaliteet
- Korrosioonikindel
- Soojuslik mälu
- Kerge ja väga elastne
- Vastupidav



Kirjeldus

- Torud: peroksiidmeetodil ristseotud polüetüleen (PE-Xa), vast. EN ISO 15875
- 5-kihiline
- Kasutusklass 2 - soe tarbevesi
- Tuleklass E vastvalt DIN EN 13501-1.

Kasutusala

- Tarbevesi: püsiv töötemperatuur 0°C kuni 70°C maksimaalsel püsival tööühul 10 bar. Lühiajaline avariitemperatuur 95°C 100 tundi kasutusaja jooksul.

Uponor Aqua Pipe toru PN6

- Tööõhk 6 bar
- Rull

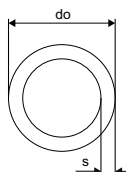

| Art. nr. | Dimension | L m | do mm | s mm | p bar | värvus - | uPoints | 2. pak. | pakend | UOM |
|----------------|------------|--------|----------|---------|----------|-------------|---------|---------|--------|-----|
| 1048757 | 32x2,9 50m | 50 | 32 | 2,9 | 6 | nat. | 400 | 550 | 50 | m |

Uponor Aqua Pipe toru PN10

- Tööõhk 10 bar
- Rull

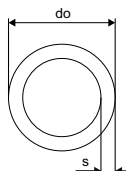

| Art. nr. | Dimension | L m | do mm | s mm | p bar | värvus - | uPoints | 2. pak. | pakend | UOM |
|----------------|-------------|--------|----------|---------|----------|-------------|---------|---------|--------|-----|
| 1022682 | 16x2,2 100m | 100 | 16 | 2,2 | 10 | nat. | 200 | 1100 | 100 | m |
| 1001201 | 20x2,8 50m | 50 | 20 | 2,8 | 10 | nat. | 200 | 550 | 50 | m |
| 1001202 | 25x3,5 50m | 50 | 25 | 3,5 | 10 | nat. | 300 | 400 | 50 | m |
| 1001203 | 32x4,4 50m | 50 | 32 | 4,4 | 10 | nat. | 400 | 350 | 50 | m |

Uponor Radi Pipe



Uponor Radi Pipe on valmistatud kõrgeima kvaliteediga ristseotud polüetüleenist ja on mõeldud kasutamiseks kütte- ning jahutussüsteemides

Eelised

- Sertifitseeritud kvaliteet
- Soojuslik mälu
- Kerge, elastne
- Vastupidav
- Hapniku difusioonikindel



Kirjeldus

- Torud: peroksiidmeetodil ristseotud polüetüleen (PE-Xa), vast. EN ISO 15875
- 5-kihiline
- EVOH (etüül vinüül alkohol) kiht hapniku difusiooni takistamiseks vast. DIN 4726
- Kasutusklass 5 - kõrgetemperatuuriline radiaatorküte
- Tuleklass E vastavalt DIN EN 13501-1.

Kasutusala

- Küte: püsiv töötemperatuur kuni 90°C. Lühiajaline avariitemperatuur 100°C kuni 100 tundi kasutusaja jooksul.

Uponor Radi Pipe toru PN6

- Töörõhk 6 bar
- Rull

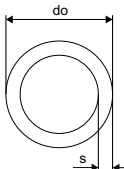

| Art. nr. | Dimension | L m | do mm | s mm | p bar | värvus | uPoints | 2. pak. | pakend | UOM |
|----------------|-----------|--------|----------|---------|----------|--------|---------|---------|--------|-------|
| 1047610 | 16x2,0 | 120m | 120 | 16 | 2,0 | 6 | nat. | 200 | 960 | 120 m |
| 1022518 | 20x2,0 | 120m | 120 | 20 | 2,0 | 6 | nat. | 300 | 840 | 120 m |
| 1022689 | 25x2,3 | 50m | 50 | 25 | 2,3 | 6 | nat. | 200 | 450 | 50 m |
| 1001220 | 32x2,9 | 50m | 50 | 32 | 2,9 | 6 | nat. | 300 | 550 | 50 m |
| 1008979 | 40x3,7 | 50m | 50 | 40 | 3,7 | 6 | nat. | 950 | 350 | 50 m |
| 1008980 | 50x4,6 | 50m | 50 | 50 | 4,6 | 6 | nat. | 1500 | 350 | 50 m |
| 1008981 | 63X5,8 | 50m | 50 | 63 | 5,8 | 6 | nat. | 2550 | 350 | 50 m |

Uponor Combi Pipe

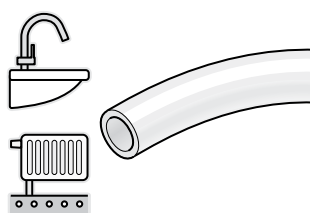

Uponor Combi Pipe ühendab endas Uponor Aqua Pipe ja Uponor Radi Pipe omadusi ning on mõeldud kasutamiseks tarbevee-, kütte- ja jahutussüsteemides

Eelised

- Sertifitseeritud kvaliteet
- Hapniku difusioonikindel
- Termilise mäluga
- Kerge ja elastne
- Kauakestev



Uponor Combi Pipe kaitse hülsis

Kirjeldus

- Torud: Ristseotud polüetüleen (PE-Xa), vast. EN ISO 15875
- EVOH (etüül vinüül alkohol) kiht hapniku difusiooni takistamiseks vast. DIN 4726
- Kasutusklass 2 - soe tarbevesi
- Kasutusklass 4 - põrandaküte ja madalatemperatuuriline radiaatorküte
- Kasutusklass 5 - kõrgetemperatuuriline radiaatorküte
- Tuleklass E vastavalt DIN EN 13501-1
- Hülsstoru: kõrgtihe polüetüleen

Kasutusala

- Tarbevesi: püsiv töötemperatuur 0°C kuni 70°C maksimaalsel püsival töö rõhul 10 bar. Lühiajaline avariitemperatuur 95°C kuni 100 tundi kasutusea jooksul.
- Küte: püsiv töötemperatuur kuni 90°C maksimaalsel püsival töö rõhul 6 bar. Lühiajaline avariitemperatuur 100°C kuni 100 tundi kasutusea jooksul.
- Lekkekindel paigaldus. Vigastuse korral sisemise toru vahetamise võimalus

Uponor Combi Pipe hülsis valge

- Töö rõhk 10 bar
- Rull

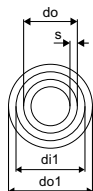

| Art. nr. | Dimension | L m | di1 mm | do mm | do1 mm | s mm | p bar | värvus | uPoints | 2. pak. | pakend | UOM |
|----------------|------------------|--------|-----------|----------|-----------|---------|----------|--------|---------|---------|--------|-----|
| 1087905 | 16x2,0 25/20 50m | 50 | 20 | 16 | 25 | 2,0 | 10 | valge | 350 | 550 | 50 | m |
| 1047829 | 20x2,8 28/23 50m | 50 | 23 | 20 | 28 | 2,8 | 10 | valge | 500 | 350 | 50 | m |

Uponor Teck

Gofreeritud hülstoru torude kaitseks tarbevee-, kütte- ja jahutussüsteemides

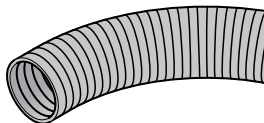

Eelised

- Tagab ohutu paigalduse
- Sertifitseeritud kvaliteet
- Kaitseb voolutoru
- Erinevad värvid sooja ja külma veele



Kirjeldus

- Gofreeritud, kõrgtihen polüetüleen (HDPE)
- Tuleklass E vastavalt EN 13501-1
- Rullides.

Kasutusala

- Kasutatakse toru-torus paigaldusel lekkeriskide vähendamiseks. Võimaldab vajadusel sisetoru väljavahetamist

Uponor Teck hülstoru punane

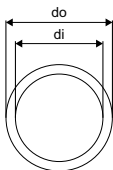

| Art. nr. | Dimension | L m | di mm | do mm | värvus | 2. pak. | pakend | UOM |
|----------------|---------------|--------|----------|----------|--------|---------|--------|-----|
| 1012858 | 25/20 red 50m | 50 | 20 | 25 | punane | 2500 | 50 | m |
| 1012862 | 28/23 red 50m | 50 | 23 | 28 | punane | 2000 | 50 | m |

Uponor Teck hülstoru sinine

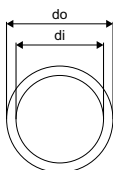

| Art. nr. | Dimension | L m | di mm | do mm | värvus | 2. pak. | pakend | UOM |
|----------------|----------------|--------|----------|----------|--------|---------|--------|-----|
| 1012859 | 25/20 blue 50m | 50 | 20 | 25 | sinine | 2500 | 50 | m |
| 1012863 | 28/23 blue 50m | 50 | 23 | 28 | sinine | 2000 | 50 | m |

Uponor Teck hülstoru must

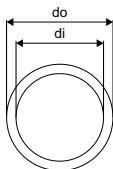

| Art. nr. | Dimension | L m | di mm | do mm | värvus | 2. pak. | pakend | UOM |
|----------------|-----------------|--------|----------|----------|--------|---------|--------|-----|
| 1012860 | 25/20 black 50m | 50 | 20 | 25 | must | 2500 | 50 | m |
| 1012864 | 28/23 black 50m | 50 | 23 | 28 | must | 2000 | 50 | m |
| 1012869 | 35/29 black 50m | 50 | 29 | 35 | must | 1400 | 50 | m |
| 1012872 | 43/36 black 25m | 25 | 36 | 43 | must | 600 | 25 | m |
| 1023127 | 54/48 black 25m | 25 | 48 | 54 | must | 600 | 25 | m |

Uponor Q&E

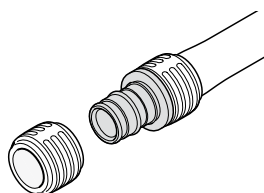

Uponor Q&E on unikaalne ühendussüsteem, kus kasutatakse ristseotud polüetüleenist PE-Xa torude kokkutõmbumisvõimet. Lai liitmike ja tarvikute valik võimaldab kiire ja lihtsa paigalduse.

Eelised

- PEX-a toru ja liitmiku ideaalne liide
- Korrosioonikindel paigaldus
- Väikese rõhukaoga liitmikud
- Ergonoomilise kujuga rõngas



Kirjeldus

Q&E liitmikud ja rõngad Uponor Pex torudele. Metallliitmikud kõrgekvaliteedilise messingist. PPSU plastliitmikud. Q&E rõngad ei ole liitmikega komplektis.

Kasutusala

- Liitmikud PE-Xa torule
- Liitmikud sobivad ka ECOFLEX süsteemis kasutamiseks
- Keermesliitmike välis- ja sisekeermed vastavalt EN 10226-1.

Uponor Q&E evolution rõngas valge

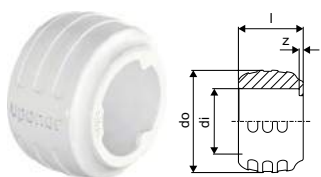

| Art. nr. | Dimension | l mm | di mm | do mm | z mm | p bar | värvus - | 2. pak. | pakend | UOM |
|----------|-----------|---------|----------|----------|---------|----------|-------------|---------|--------|-----|
| 1057453 | 16 | 16 | 16,2 | 25,3 | 1 | 6+10 | valge | 900 | 20 | tk |
| 1057454 | 20 | 20 | 20,2 | 29,2 | 1 | 6+10 | valge | 520 | 20 | tk |
| 1057455 | 25 | 25 | 25,3 | 34,6 | 1 | 6+10 | valge | 300 | 20 | tk |
| 1057456 | 32 | 32 | 32,4 | 41,8 | 1 | 6+10 | valge | 150 | 10 | tk |

Uponor Q&E evolution rõngas punane

- Koonilise välispinnaga
- Piirajaga
- Polüetüleen

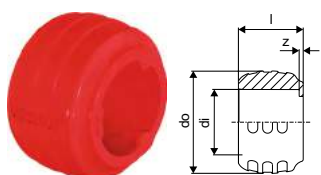

| Art. nr. | Dimension | l mm | di mm | do mm | z mm | p bar | värvus - | 2. pak. | pakend | UOM |
|----------|-----------|---------|----------|----------|---------|----------|-------------|---------|--------|-----|
| 1058010 | 16 | 16 | 16,2 | 25,3 | 1 | 6+10 | punane | 900 | 20 | tk |
| 1058011 | 20 | 20 | 20,2 | 29,2 | 1 | 6+10 | punane | 520 | 20 | tk |
| 1058012 | 25 | 25 | 25,3 | 34,6 | 1 | 6+10 | punane | 300 | 20 | tk |

Uponor Q&E evolution rõngas sinine

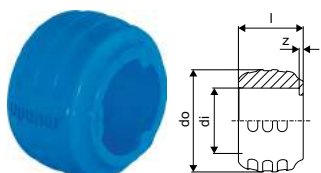

| Art. nr. | Dimension | l mm | di mm | do mm | z mm | p bar | värvus - | 2. pak. | pakend | UOM |
|----------|-----------|---------|----------|----------|---------|----------|-------------|---------|--------|-----|
| 1058013 | 16 | 16 | 16,2 | 25,3 | 1 | 6+10 | sinine | 900 | 20 | tk |
| 1058014 | 20 | 20 | 20,2 | 29,2 | 1 | 6+10 | sinine | 520 | 20 | tk |
| 1058015 | 25 | 25 | 25,3 | 34,6 | 1 | 6+10 | sinine | 300 | 20 | tk |

Uponor Q&E

Uponor Q&E rõngas piirajaga naturaalne

- Piirajaga
- PE-X

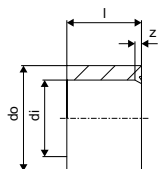

| Art. nr. | Dimension | l mm | di mm | do mm | z mm | p bar | värvus - | 2. pak. | pakend | UOM |
|----------------|-----------|---------|----------|----------|---------|----------|-------------|---------|--------|-----|
| 1045464 | 40 | 41 | 40,8 | 50,2 | 3 | 6+10 | nat. | 80 | 5 | tk |
| 1045489 | 50 | 50 | 51 | 63 | 4 | 6+10 | nat. | 70 | 5 | tk |
| 1045490 | 63 | 63 | 64,3 | 75,7 | 4 | 6+10 | nat. | 35 | 5 | tk |
| 1085087 | 75 | 76 | 76,3 | 88,3 | 4 | 6+10 | nat. | 18 | 2 | tk |

Uponor Q&E põlv PPSU

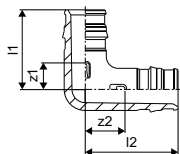

| Art. nr. | Dimension | l1 mm | l2 mm | z1 mm | z2 mm | p bar | 2. pak. | pakend | UOM |
|----------------|-----------|----------|----------|----------|----------|----------|---------|--------|-----|
| 1008679 | 16-16 | 27 | 32 | 9 | 13 | 6+10 | 100 | 5 | tk |
| 1008680 | 20-20 | 34 | 39 | 12 | 16 | 6+10 | 40 | 5 | tk |
| 1008681 | 25-25 | 42 | 47 | 14 | 19 | 6+10 | 25 | 5 | tk |
| 1001245 | 32-32 | 53 | 59 | 18 | 23 | 6+10 | 15 | 1 | tk |
| 1008683 | 40-40 | 65 | 74 | 21 | 29 | 6+10 | 10 | 1 | tk |
| 1042859 | 50-50 | 83 | 98 | 29 | 44 | 6+10 | 5 | 1 | tk |
| 1042858 | 63-63 | 100 | 112 | 33 | 44 | 6+10 | 3 | 1 | tk |
| 1085080 | 75-75 | 149 | 149 | 64 | 65 | 6+10 | 2 | 1 | tk |

Uponor Q&E jätk PPSU

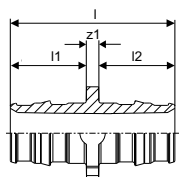

| Art. nr. | Dimension | l mm | l1 mm | l2 mm | z1 mm | p bar | 2. pak. | pakend | UOM |
|----------------|-----------|---------|----------|----------|----------|----------|---------|--------|-----|
| 1008669 | 16-16 | 39 | 18 | 18 | 3 | 6+10 | 100 | 5 | tk |
| 1008932 | 20-20 | 47 | 22 | 22 | 3 | 6+10 | 80 | 5 | tk |
| 1008671 | 25-25 | 58 | 28 | 28 | 3 | 6+10 | 50 | 5 | tk |
| 1001235 | 32-32 | 73 | 35 | 35 | 3 | 6+10 | 20 | 1 | tk |
| 1008673 | 40-40 | 90 | 44 | 44 | 3 | 6+10 | 10 | 1 | tk |
| 1042866 | 50-50 | 113 | 54 | 54 | 5 | 6+10 | 10 | 1 | tk |
| 1042865 | 63-63 | 141 | 68 | 68 | 6 | 6+10 | 5 | 1 | tk |
| 1085084 | 75-75 | 179 | 86 | 86 | 7 | 6+10 | 10 | 1 | tk |

Uponor Q&E

Uponor Q&E siirdmik PPSU

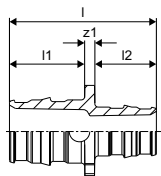

| Art. nr. | Dimension | l mm | l1 mm | l2 mm | z1 mm | p bar | 2. pak. | pakend | UOM |
|----------------|-----------|---------|----------|----------|----------|----------|---------|--------|-----|
| 1008674 | 20-16 | 43 | 22 | 18 | 3 | 6+10 | 100 | 5 | tk |
| 1008675 | 25-16 | 49 | 28 | 18 | 3 | 6+10 | 40 | 5 | tk |
| 1008676 | 25-20 | 53 | 22 | 28 | 3 | 6+10 | 40 | 5 | tk |
| 1001240 | 32-25 | 66 | 28 | 35 | 3 | 6+10 | 20 | 1 | tk |
| 1008678 | 40-32 | 82 | 35 | 44 | 3 | 6+10 | 10 | 1 | tk |
| 1042879 | 50-32 | 94 | 54 | 35 | 5 | 6+10 | 10 | 1 | tk |
| 1042867 | 50-40 | 103 | 54 | 44 | 5 | 6+10 | 10 | 1 | tk |
| 1042878 | 63-40 | 117 | 68 | 44 | 6 | 6+10 | 5 | 1 | tk |
| 1042877 | 63-50 | 128 | 68 | 54 | 6 | 6+10 | 5 | 1 | tk |
| 1085086 | 75-50 | 147 | 86 | 54 | 6 | 6+10 | 10 | 1 | tk |
| 1085085 | 75-63 | 160 | 86 | 68 | 7 | 6+10 | 10 | 1 | tk |

Uponor Q&E kolmik PPSU

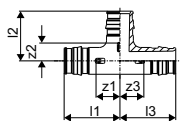

| Art. nr. | Dimension | l1 mm | l2 mm | l3 mm | z1 mm | z2 mm | z3 mm | p bar | 2. pak. | pakend | UOM |
|----------------|-----------|----------|----------|----------|----------|----------|----------|----------|---------|--------|-----|
| 1008684 | 16-16-16 | 32 | 27 | 32 | 14 | 10 | 14 | 6+10 | 70 | 5 | tk |
| 1008685 | 20-20-20 | 39 | 34 | 39 | 17 | 12 | 17 | 6+10 | 35 | 5 | tk |
| 1008686 | 25-25-25 | 47 | 42 | 47 | 20 | 15 | 20 | 6+10 | 25 | 5 | tk |
| 1001250 | 32-32-32 | 59 | 53 | 59 | 24 | 18 | 24 | 6+10 | 10 | 1 | tk |
| 1008688 | 40-40-40 | 74 | 65 | 74 | 30 | 22 | 30 | 6+10 | 5 | 1 | tk |
| 1042861 | 50-50-50 | 92 | 83 | 92 | 38 | 29 | 38 | 6+10 | 3 | 1 | tk |
| 1042860 | 63-63-63 | 112 | 102 | 112 | 44 | 5 | 44 | 6+10 | 2 | 1 | tk |
| 1085081 | 75-75-75 | 156 | 123 | 156 | 70 | 37 | 70 | 6+10 | 2 | 1 | tk |

Uponor Q&E

Uponor Q&E erikolmik PPSU

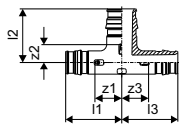

| Art. nr. | Dimension | l1 mm | l2 mm | l3 mm | z1 mm | z2 mm | z3 mm | p bar | 2. pak. | pakend | UOM |
|----------|-----------|----------|----------|----------|----------|----------|----------|----------|---------|--------|-----|
| 1008710 | 16-20-16 | 35 | 33 | 35 | 17 | 11 | 17 | 6+10 | 40 | 5 | tk |
| 1008700 | 20-16-16 | 36 | 29 | 32 | 14 | 11 | 14 | 6+10 | 40 | 5 | tk |
| 1008689 | 20-16-20 | 36 | 29 | 36 | 14 | 11 | 14 | 6+10 | 40 | 5 | tk |
| 1008697 | 20-20-16 | 36 | 34 | 32 | 14 | 12 | 14 | 6+10 | 40 | 5 | tk |
| 1008711 | 20-25-20 | 42 | 40 | 42 | 20 | 12 | 20 | 6+10 | 25 | 5 | tk |
| 1008702 | 25-16-16 | 41 | 32 | 32 | 14 | 14 | 14 | 6+10 | 25 | 5 | tk |
| 1008699 | 25-16-20 | 41 | 32 | 36 | 14 | 14 | 14 | 6+10 | 25 | 5 | tk |
| 1008690 | 25-16-25 | 41 | 32 | 41 | 14 | 14 | 14 | 6+10 | 25 | 5 | tk |
| 1008701 | 25-20-16 | 44 | 37 | 35 | 17 | 15 | 17 | 6+10 | 25 | 5 | tk |
| 1008703 | 25-20-20 | 44 | 37 | 39 | 17 | 15 | 17 | 6+10 | 25 | 5 | tk |
| 1008691 | 25-20-25 | 44 | 37 | 44 | 17 | 15 | 17 | 6+10 | 25 | 5 | tk |
| 1001420 | 25-25-20 | 47 | 42 | 42 | 20 | 15 | 20 | 6+10 | 25 | 5 | tk |
| 1008712 | 25-32-25 | 52 | 50 | 52 | 24 | 15 | 24 | 6+10 | 15 | 1 | tk |
| 1001422 | 32-20-25 | 52 | 40 | 44 | 17 | 18 | 17 | 6+10 | 15 | 1 | tk |
| 1001424 | 32-20-32 | 52 | 40 | 52 | 17 | 18 | 17 | 6+10 | 15 | 1 | tk |
| 1008704 | 32-25-20 | 55 | 45 | 42 | 20 | NaN | 20 | 6+10 | 15 | 1 | tk |
| 1001426 | 32-25-25 | 55 | 45 | 47 | 20 | 18 | 20 | 6+10 | 15 | 1 | tk |
| 1001428 | 32-25-32 | 55 | 45 | 55 | 20 | 18 | 20 | 6+10 | 15 | 1 | tk |
| 1008713 | 32-40-32 | 65 | 61 | 65 | 30 | 18 | 30 | 6+10 | 10 | 1 | tk |
| 1008707 | 40-20-32 | 60 | 44 | 52 | 17 | 22 | 17 | 6+10 | 5 | 1 | tk |
| 1008694 | 40-20-40 | 60 | 44 | 60 | 17 | 22 | 17 | 6+10 | 5 | 1 | tk |
| 1008708 | 40-25-32 | 63 | 49 | 55 | 20 | 22 | 20 | 6+10 | 5 | 1 | tk |
| 1008695 | 40-25-40 | 63 | 49 | 63 | 20 | 22 | 20 | 6+10 | 5 | 1 | tk |
| 1008709 | 40-32-32 | 68 | 57 | 59 | 24 | 22 | 24 | 6+10 | 5 | 1 | tk |
| 1008696 | 40-32-40 | 68 | 57 | 68 | 24 | 22 | 24 | 6+10 | 5 | 1 | tk |
| 1042876 | 50-25-40 | 92 | 57 | 82 | 38 | 29 | 39 | 6+10 | 4 | 1 | tk |
| 1042864 | 50-25-50 | 92 | 57 | 92 | 38 | 29 | 38 | 6+10 | 4 | 1 | tk |
| 1042863 | 50-32-50 | 92 | 64 | 92 | 38 | 29 | 38 | 6+10 | 4 | 1 | tk |
| 1042862 | 50-40-40 | 92 | 73 | 82 | 38 | 29 | 39 | 6+10 | 4 | 1 | tk |
| 1042875 | 50-40-50 | 92 | 73 | 92 | 38 | 29 | 38 | 6+10 | 4 | 1 | tk |
| 1042871 | 63-25-50 | 112 | 62 | 99 | 44 | 35 | 45 | 6+10 | 2 | 1 | tk |
| 1042873 | 63-25-63 | 112 | 60 | 112 | 44 | 33 | 44 | 6+10 | 2 | 1 | tk |
| 1042870 | 63-32-63 | 112 | 70 | 112 | 44 | 35 | 44 | 6+10 | 2 | 1 | tk |
| 1042869 | 63-40-40 | 112 | 78 | 99 | 44 | 35 | 55 | 6+10 | 2 | 1 | tk |
| 1042872 | 63-40-63 | 112 | 78 | 112 | 44 | 35 | 44 | 6+10 | 2 | 1 | tk |
| 1042868 | 63-50-50 | 112 | 89 | 99 | 44 | 35 | 45 | 6+10 | 2 | 1 | tk |
| 1042874 | 63-50-63 | 112 | 89 | 112 | 44 | 35 | 44 | 6+10 | 2 | 1 | tk |
| 1085083 | 75-25-75 | 118 | 67 | 118 | 32 | 39 | 32 | 6+10 | 4 | 1 | tk |
| 1085082 | 75-40-75 | 118 | 83 | 118 | 32 | 83 | 32 | 6+10 | 4 | 1 | tk |

Uponor Q&E

Uponor Q&E kollektor PL

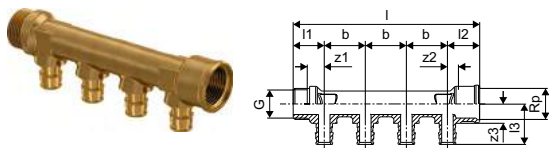

| Art. nr. | Dimension | l | l1 | l2 | l3 | G | Rp | z1 | z2 | b | väljundid | p | 2. pak. | pakend | UOM |
|----------------|------------------------|-----|----|----|----|-----|-----|----|----|----|-----------|------|---------|--------|-----|
| | | mm | mm | mm | mm | " | " | mm | mm | mm | - | bar | | | |
| 1023027 | 3/4"MT/FT 2X16 c/c35mm | 89 | 27 | 28 | 35 | 3/4 | 3/4 | 15 | 9 | 35 | 2 | 6+10 | 20 | 1 | tk |
| 1023028 | 3/4"MT/FT 3X16 c/c35mm | 124 | 27 | 28 | 35 | 3/4 | 3/4 | 15 | 9 | 35 | 3 | 6+10 | 15 | 1 | tk |
| 1023029 | 3/4"MT/FT 4X16 c/c35mm | 159 | 27 | 28 | 35 | 3/4 | 3/4 | 15 | 9 | 35 | 4 | 6+10 | 10 | 1 | tk |

Uponor Q&E kollektor ventiilidega PL SH

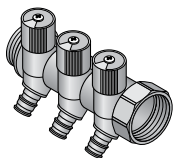

| Art. nr. | Dimension | väljundid | d | IG | p | uPoints | 2. pak. | pakend | UOM |
|----------------|----------------------|-----------|----|-----|------|---------|---------|--------|-----|
| | | - | mm | " | bar | | | | |
| 1048520 | 1"MT/FT 2X16 c/c38mm | 2 | 16 | G 1 | 6+10 | 150 | 32 | 1 | tk |
| 1048521 | 1"MT/FT 3X16 c/c38mm | 3 | 16 | G 1 | 6+10 | 200 | 32 | 1 | tk |
| 1048522 | 1"MT/FT 4X16 c/c38mm | 4 | 16 | G 1 | 6+10 | 250 | 24 | 1 | tk |

Uponor Aqua PLUS kollektori kandja SH

■ Kollektori kandur



| Art. nr. | Dimension | 2. pak. | pakend | UOM |
|-----------------|-----------|---------|--------|--------|
| 1045451* | 3/4" 1" | 25 | 1 | kompl. |

Uponor Q&E otsik väliskeere PL

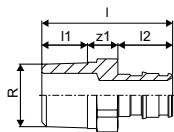

| Art. nr. | Dimension | l | l1 | l2 | R | z1 | p | 2. pak. | pakend | UOM |
|----------------|-----------|----|----|----|-----|----|------|---------|--------|-----|
| | | mm | mm | mm | " | mm | bar | | | |
| 1047191 | 32-R1"MT | 65 | 21 | 34 | 3/4 | 10 | 6+10 | 10 | 1 | tk |

Uponor Q&E otsik väliskeere PL/DR

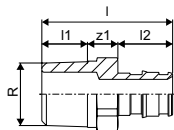

| Art. nr. | Dimension | l | l1 | l2 | R | z1 | p | 2. pak. | pakend | UOM |
|----------------|--------------|-----|----|----|-------|----|------|---------|--------|-----|
| | | mm | mm | mm | " | mm | bar | | | |
| 1085077 | 40-R1 1/4"MT | 73 | 19 | 42 | 1 1/4 | 12 | 6+10 | 16 | 1 | tk |
| 1085076 | 50-R1 1/2"MT | 89 | 20 | 52 | 1 1/2 | 17 | 6+10 | 8 | 1 | tk |
| 1085075 | 63-R2"MT | 100 | 24 | 65 | 2 | 11 | 6+10 | 6 | 1 | tk |
| 1085074 | 75-R2 1/2"MT | 126 | 27 | 86 | 2 1/2 | 13 | 6+10 | 6 | 1 | tk |

Uponor Q&E

Uponor Q&E otsik väliskeere PL

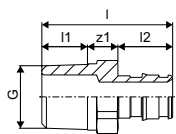

| Art. nr. | Dimension | l | l1 | l2 | G | z1 | p | 2. pak. | pakend | UOM |
|----------------|--------------|----|----|----|-------|----|------|---------|--------|-----|
| | | mm | mm | mm | " | mm | bar | | | |
| 1033435 | 16-G1/2"MT | 36 | 10 | 18 | 1/2 | 8 | 6+10 | 100 | 5 | tk |
| 1033437 | 20-G1/2"MT | 40 | 9 | 22 | 1/2 | 9 | 6+10 | 90 | 5 | tk |
| 1033438 | 20-G3/4"MT | 43 | 11 | 22 | 3/4 | 10 | 6+10 | 70 | 5 | tk |
| 1047862 | 25-G3/4"MT | 48 | 11 | 27 | 3/4 | 10 | 6+10 | 40 | 5 | tk |
| 1047863 | 25-G1"MT | 49 | 11 | 27 | 1 | 11 | 6+10 | 40 | 5 | tk |
| 1047864 | 50-G1 1/2"MT | 82 | 17 | 52 | 1 1/2 | 13 | 6+10 | 8 | 1 | tk |

Uponor Q&E otsik väliskeere PL W

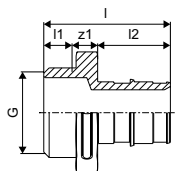

| Art. nr. | Dimension | l | l1 | l2 | G | z1 | p | 2. pak. | pakend | UOM |
|----------------|--------------|----|----|----|-------|----|------|---------|--------|-----|
| | | mm | mm | mm | " | mm | bar | | | |
| 1008730 | 32-G1"MT | 56 | 10 | 34 | 1 | 12 | 6+10 | 20 | 1 | tk |
| 1008732 | 40-G1 1/4"MT | 68 | 14 | 42 | 1 1/4 | 12 | 6+10 | 8 | 1 | tk |
| 1008866 | 50-G1 1/4"MT | 78 | 14 | 52 | 1 1/4 | 12 | 6+10 | 8 | 1 | tk |
| 1008867 | 63-G2"MT | 95 | 17 | 65 | 2 | 13 | 6+10 | 6 | 1 | tk |

Uponor Q&E otsik sisekeere PL

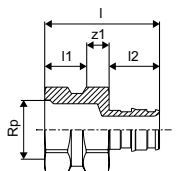

| Art. nr. | Dimension | l | l1 | l2 | Rp | z1 | p | 2. pak. | pakend | UOM |
|----------------|-------------|----|----|----|-----|----|------|---------|--------|-----|
| | | mm | mm | mm | " | mm | bar | | | |
| 1023009 | 16-Rp1/2"FT | 41 | 15 | 18 | 1/2 | 8 | 6+10 | 60 | 5 | tk |
| 1023010 | 20-Rp1/2"FT | 44 | 15 | 22 | 1/2 | 7 | 6+10 | 60 | 5 | tk |
| 1023011 | 20-Rp3/4"FT | 46 | 18 | 22 | 3/4 | 6 | 6+10 | 40 | 5 | tk |
| 1023012 | 25-Rp3/4"FT | 51 | 18 | 27 | 3/4 | 6 | 6+10 | 40 | 5 | tk |
| 1023013 | 25-Rp1"FT | 55 | 22 | 27 | 1 | 6 | 6+10 | 35 | 5 | tk |

Uponor Q&E otsik sisekeere PL/DR

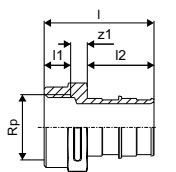

| Art. nr. | Dimension | l | l1 | l2 | Rp | z1 | p | 2. pak. | pakend | UOM |
|----------------|---------------|----|----|----|-------|----|------|---------|--------|-----|
| | | mm | mm | mm | " | mm | bar | | | |
| 1085078 | 50-RP1 1/2"FT | 92 | 21 | 52 | 1 1/2 | 19 | 6+10 | 8 | 1 | tk |

Uponor Q&E

Uponor Q&E otsik sisekeere PL

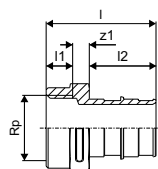

| Art. nr. | Dimension | l mm | l1 mm | l2 mm | G " | z1 mm | p bar | 2. pak. | pakend | UOM |
|----------------|--------------|---------|----------|----------|--------|----------|----------|---------|--------|-----|
| 1047866 | 32-G1"FT | 56 | 13 | 34 | 1 | 9 | 6+10 | 20 | 1 | tk |
| 1047867 | 40-G1 1/4"FT | 68 | 16 | 42 | 1 1/4 | 10 | 6+10 | 20 | 1 | tk |

Uponor Q&E põlv väliskeere PL

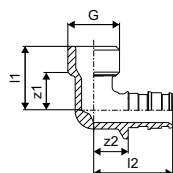

| Art. nr. | Dimension | l1 mm | l2 mm | G " | z1 mm | z2 mm | p bar | 2. pak. | pakend | UOM |
|----------------|--------------|----------|----------|--------|----------|----------|----------|---------|--------|-----|
| 1023019 | 16-G1/2"MT | 26 | 32 | 1/2 | 16 | 14 | 6+10 | 80 | 5 | tk |
| 1023020 | 20-G1/2"MT | 29 | 33 | 1/2 | 17 | 21 | 6+10 | 50 | 5 | tk |
| 1023021 | 20-G3/4"MT | 29 | 36 | 3/4 | 18 | 14 | 6+10 | 40 | 5 | tk |
| 1023022 | 25-G3/4"MT | 29 | 41 | 3/4 | 20 | 14 | 6+10 | 40 | 5 | tk |
| 1047878 | 40-G1 1/4"MT | 61 | 74 | 1 1/4 | 46 | 32 | 6+10 | 10 | 1 | tk |

Uponor Q&E põlv sisekeere PL

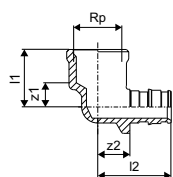

| Art. nr. | Dimension | l1 mm | l2 mm | G " | z1 mm | z2 mm | p bar | 2. pak. | pakend | UOM |
|----------------|------------|----------|----------|--------|----------|----------|----------|---------|--------|-----|
| 1023023 | 16-G1/2"FT | 25 | 32 | 1/2 | 11 | 14 | 6+10 | 70 | 5 | tk |
| 1023024 | 20-G1/2"FT | 25 | 36 | 1/2 | 11 | 14 | 6+10 | 50 | 5 | tk |
| 1023025 | 20-G3/4"FT | 26 | 39 | 3/4 | 10 | 17 | 6+10 | 30 | 5 | tk |
| 1023026 | 25-G3/4"FT | 26 | 44 | 3/4 | 10 | 17 | 6+10 | 35 | 5 | tk |

Uponor Q&E kolmik sisekeere PL

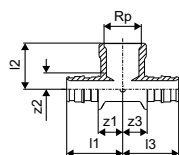

| Art. nr. | Dimension | l1 mm | l2 mm | l3 mm | Rp1 " | z1 mm | z2 mm | z3 mm | p bar | 2. pak. | pakend | UOM |
|----------------|----------------|----------|----------|----------|----------|----------|----------|----------|----------|---------|--------|-----|
| 1047885 | 16-Rp1/2"FT-16 | 32 | 26 | 32 | 1/2 | 14 | 9 | 14 | 6+10 | 50 | 5 | tk |
| 1047886 | 20-Rp1/2"FT-20 | 36 | 28 | 36 | 1/2 | 14 | 11 | 14 | 6+10 | 30 | 5 | tk |

Uponor Q&E

Uponor Q&E otsik pöördmutriga PL

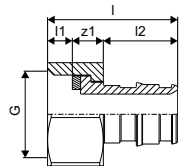

| Art. nr. | Dimension | l mm | l1 mm | l2 mm | G " | z1 mm | p bar | 2. pak. | pakend | UOM |
|----------------|------------|---------|----------|----------|--------|----------|----------|---------|--------|-----|
| 1023014 | 16-G1/2"SN | 32 | 6 | 18 | 1/2 | 8 | 6+10 | 100 | 5 | tk |
| 1023015 | 20-G1/2"SN | 42 | 8 | 22 | 1/2 | 13 | 6+10 | 60 | 5 | tk |
| 1023016 | 20-G3/4"SN | 36 | 7 | 22 | 3/4 | 8 | 6+10 | 50 | 5 | tk |
| 1023017 | 25-G3/4"SN | 49 | 7 | 27 | 3/4 | 15 | 6+10 | 45 | 5 | tk |
| 1023018 | 25-G1"SN | 44 | 10 | 27 | 1 | 7 | 6+10 | 40 | 5 | tk |

Uponor Q&E kork

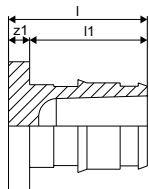

| Art. nr. | Dimension | l mm | l1 mm | z1 mm | 2. pak. | pakend | UOM |
|----------------|-----------|---------|----------|----------|---------|--------|-----|
| 1084671 | 16 | 23 | 20 | 4 | 200 | 20 | tk |

Uponor Q&E

Uponor Smart Aqua

Kirjeldus

- Kraanipõlved tarbevee ühendusteks
- Q&E rõngad tellida eraldi

Kasutusala

- Tarbevee ühendusteks
- Välis- ja sisekeerved vast. EN 10226-1.

Uponor Smart Aqua U-kraanipõlv Q&E

- U-põlv ringpaigalduseks

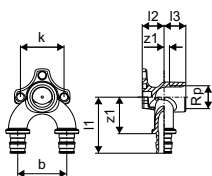

| Art. nr. | Dimension | l1 mm | l2 mm | l3 mm | Rp mm | z1 mm | z2 mm | b mm | k mm | 2. pak. | pakend | UOM |
|-----------------|----------------|----------|----------|----------|----------|----------|----------|---------|---------|---------|--------|-----|
| 1059820* | 16-Rp1/2"FT-16 | 52 | 20 | 20 | 1/2 | 34 | 5 | 45 | 40 | 5 | 1 | tk |
| 1059821* | 20-Rp1/2"FT-20 | 56 | 20 | 20 | 1/2 | 35 | 5 | 45 | 40 | 5 | 1 | tk |

Uponor Smart Aqua kraanipõlv Q&E PL

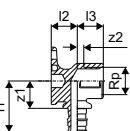

| Art. nr. | Dimension | l1 mm | l2 mm | l3 mm | Rp mm | z1 mm | z2 mm | p bar | 2. pak. | pakend | UOM |
|----------------|-------------|----------|----------|----------|----------|----------|----------|----------|---------|--------|-----|
| 1059822 | 16-Rp1/2"FT | 39 | 20 | 20 | 1/2 | 21 | 5 | 6+10 | 40 | 5 | tk |
| 1059823 | 20-Rp1/2"FT | 40 | 20 | 20 | 1/2 | 18 | 5 | 6+10 | 40 | 5 | tk |

Uponor Smart Aqua kraanipõlve paigaldusplaat

- Galvaniseeritud teras.
- Uponor Smart Aqua kraanipõlvede paigaldamiseks
- Positioneerimine vastavalt eeltöödeldud avadele
- Komplektis plastihvitiid ja kruvid vastavalt DIN 965
- Kinnitusavad täpseks paigalduseks

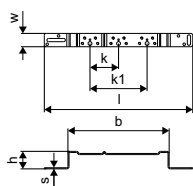

| Art. nr. | Dimension | l mm | s mm | b mm | h mm | k mm | k1 mm | w mm | 2. pak. | pakend | UOM |
|----------------|-----------|---------|---------|---------|---------|---------|----------|---------|---------|--------|-----|
| 1057842 | 75/150mm | 390 | 3 | 266 | 46 | 75 | 150 | 35 | 165 | 5 | tk |

Uponor Q&E

Uponor Smart Aqua kraanipõlve paigaldusplaat

- Galvaniseeritud teras.
- Uponor Smart Aqua kraanipõlvede paigaldamiseks
- Positsioneerimine vastavalt eeltöödeldud avadele
- Komplektis plasttihvtid ja kruvid vastavalt DIN 965
- Kinnitusavad täpseks paigalduseks

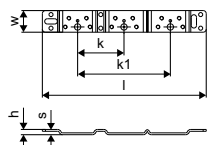

| Art. nr. | Dimension | l mm | s mm | h mm | k mm | k1 mm | w mm | 2. pak. | pakend | UOM |
|----------------|-----------|---------|---------|---------|---------|----------|---------|---------|--------|-----|
| 1057840 | 75/150mm | 265 | 3,0 | 9 | 75 | 150 | 35 | 5 | 1 | tk |

Uponor Smart Aqua kraanipõlve paigaldusnurk

- Galvaniseeritud teras.
- Uponor Smart Aqua kraanipõlvede paigaldamiseks
- Positsioneerimine vastavalt eeltöödeldud avadele
- Komplektis plasttihvtid ja kruvid vastavalt DIN 965
- Kinnitusavad täpseks paigalduseks

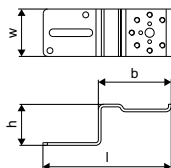
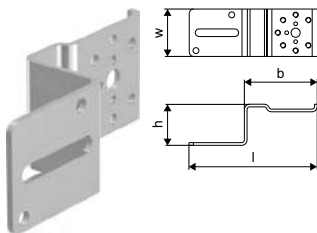

| Art. nr. | l mm | b mm | h mm | 2. pak. | pakend | UOM |
|----------------|---------|---------|---------|---------|--------|-----|
| 1057843 | 144 | 82 | 46 | 5 | 1 | tk |

Uponor Smart Aqua kraanipõlve paigalduslatt 2m

- Galvaniseeritud teras.
- Uponor Smart Aqua kraanipõlvede paigaldamiseks
- Positsioneerimine vastavalt eeltöödeldud avadele
- Komplektis plasttihvtid ja kruvid vastavalt DIN 965
- Kinnitusavad täpseks paigalduseks

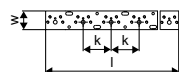

| Art. nr. | Dimension | l mm | k mm | 2. pak. | pakend | UOM |
|----------------|-----------|---------|---------|---------|--------|-----|
| 1057844 | 2m | 2000 | 75 | 10 | 1 | tk |

Uponor Q&E

Uponor Smart Aqua kraanipölv Q&E PL



| Art. nr. | Dimension | l1 mm | l2 mm | l3 mm | Rp " | z1 mm | z2 mm | k mm | p bar | 2. pak. | pakend | UOM |
|----------------|--------------------|----------|----------|----------|---------|----------|----------|---------|----------|---------|--------|-----|
| 1023034 | 16-Rp1/2"FT l=43mm | 32 | 17 | 27 | 1/2 | 14 | 10 | 36 | 6+10 | 40 | 5 | tk |
| 1023035 | 20-Rp1/2"FT l=43mm | 36 | 17 | 27 | 1/2 | 14 | 10 | 36 | 6+10 | 40 | 5 | tk |

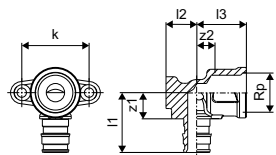

Uponor Smart Aqua mürasummuti

- komplekt kahele Uponor Smart Aqua kraanipölevele 16-Rp1/2"SK või 20-Rp1/2"SK
- komplektis tihvtid ja kruvid M6 x 16
- materjal EPDM.
- heli summutus vastavalt DIN 4109.



NEW

| Art. nr. | l1 mm | l2 mm | z1 mm | pakend | UOM |
|-----------------|----------|----------|----------|--------|--------|
| 1057846* | 30 | 18 | 6 | 1 | kompl. |

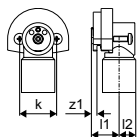

Uponor Q&E

Uponor Smart Radi

Kirjeldus

- Liitmikud ja tarvikud radiaatorite ühendamiseks
- Q&E rõngad tellida eraldi

Kasutusala

- Kõrge- ja madalatemperatuuriline radiaatorküte

Uponor Smart Radi radiaatori ühenduspõlv kroom Q&E

- pinnakattega messing
- vasktoru 15 x 1 mm, pinnakattega.
- Vasktoru 15 x 1 mm ühendamiseks radiaatoriga kasutada Uponor vase surveliitmikku (art.nr. 1013830).

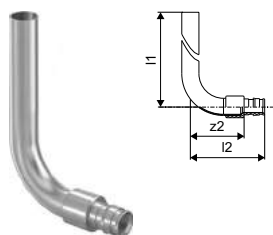

| Art. nr. | Dimension | l1 mm | l2 mm | z2 mm | p bar | 2. pak. | pakend | UOM |
|----------------|-----------------|----------|----------|----------|----------|---------|--------|-----|
| 1023045 | 16-15CU l=300mm | 300 | 65 | 47 | 6+10 | 40 | 2 | tk |
| 1023046 | 20-15CU l=300mm | 300 | 69 | 47 | 6+10 | 30 | 2 | tk |

Uponor Smart Radi radiaatori ühenduskolmik kroom Q&E

- pinnakattega messing
- vasktoru 15 x 1 mm, pinnakattega.
- Vasktoru 15 x 1 mm ühendamiseks radiaatoriga kasutada Uponor vase surveliitmikku (art.nr. 1013830).

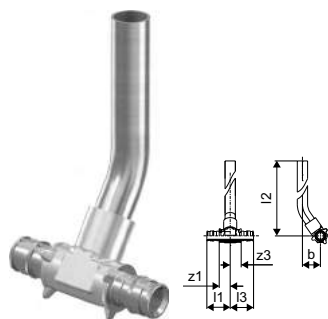

| Art. nr. | Dimension | l1 mm | l2 mm | l3 mm | z1 mm | z3 mm | p bar | 2. pak. | pakend | UOM |
|-----------------|--------------------|----------|----------|----------|----------|----------|----------|---------|--------|-----|
| 1023049* | 16-15CU-16 l=300mm | 34 | 302 | 34 | 16 | 16 | 6+10 | 30 | 2 | tk |
| 1023050* | 20-15CU-20 l=300mm | 39 | 302 | 39 | 17 | 17 | 6+10 | 30 | 2 | tk |

Uponor Smart Radi paindetugi

- Valge plast.
- Põrandast tuleva 16 mm PE-Xa või MLC toru ühendamiseks radiaatoriga.
- Koostatav, hülsstorule 25/20 mm.
- Min. c/c 40 mm, komplektis 5 mm vahetükk.

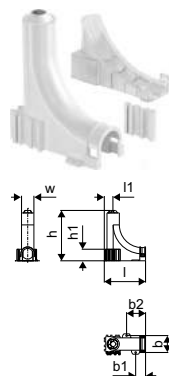

| Art. nr. | Dimension | l mm | l1 mm | b mm | b1 mm | b2 mm | h mm | h1 mm | w mm | pakend | UOM |
|----------------|-----------|---------|----------|---------|----------|----------|---------|----------|---------|--------|-----|
| 1009008 | 25/20mm | 100 | 21 | 41 | 24 | 46 | 122 | 28 | 30 | 10 | tk |

Uponor AQUA PLUS

Uponor Aqua PLUS

Kirjeldus

- Veetihedad kollektorikapid vastavalt NT VVS 129
- Kollektoritele c/c 50 mm
- M7 läbiviigid hülssidele
- Komplektis kapp, pritsmekaitse ja tarvikukomplekt koos kollektori klambritega
- Uks ja raam tuleb tellida eraldi
- RAL 9010
- Plastkollektorid paigaldamiseks veetihedatesse kappidesse
- Paigaldistes ilma kollektori kappideta ei saa rakendada NT VVS 129 veetiheduse garantiid
- Kollektoreid ja tarvikuid kasutada komplekselt
- Metallliitmikud kõrgekvaliteedilisest messingist
- Plastliitmikud PPSU
- PPM kollektorid bajonettkeermega

Kasutusala

- Veetihe paigaldis kahjude vältimiseks võimaliku lekke korral
- Igat tüüpi kollektorpaigaldistele

Uponor Aqua PLUS FS lekkekindel kollektorikapp

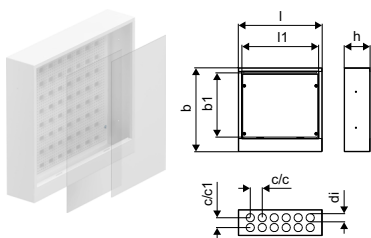

| Art. nr. | Dimension | l mm | l1 mm | di mm | c/c mm | c/c1 mm | b mm | b1 mm | h mm | värvus | uPoints | 2. pak. | pakend | UOM |
|----------------|------------------|---------|----------|----------|-----------|------------|---------|----------|---------|----------|---------|---------|--------|-----|
| 1088752 | A, 350x350x108mm | 350 | 320 | 34 | 50 | 41 | 350 | 268 | 108 | RAL 9010 | 500 | 32 | 1 | tk |
| 1088751 | A, 350x350x118mm | 350 | 320 | 34 | 50 | 41 | 350 | 268 | 118 | RAL 9010 | 450 | 32 | 1 | tk |
| 1088759 | B, 550x500x108mm | 550 | 520 | 34 | 50 | 41 | 500 | 418 | 108 | RAL 9010 | 500 | 20 | 1 | tk |
| 1088758 | B, 550x500x118mm | 550 | 520 | 34 | 50 | 41 | 500 | 418 | 118 | RAL 9010 | 550 | 12 | 1 | tk |
| 1088768 | C, 750x500x108mm | 750 | 720 | 34 | 50 | 41 | 500 | 418 | 108 | RAL 9010 | 650 | 16 | 1 | tk |
| 1088767 | C, 750x500x118mm | 750 | 720 | 34 | 50 | 41 | 500 | 418 | 118 | RAL 9010 | 650 | 16 | 1 | tk |

Uponor Aqua PLUS kapi raam



| Art. nr. | Dimension | l mm | l1 mm | b mm | b1 mm | h mm | värvus | 2. pak. | pakend | UOM |
|----------------|--------------|---------|----------|---------|----------|---------|----------|---------|--------|-----|
| 1088754 | A, 390x385mm | 390 | 320 | 385 | 268 | 18 | RAL 9010 | | 1 | tk |
| 1088762 | B, 590x535mm | 590 | 520 | 535 | 418 | 18 | RAL 9010 | 50 | 1 | tk |
| 1088770 | C, 790x535mm | 790 | 720 | 535 | 418 | 18 | RAL 9010 | 46 | 1 | tk |

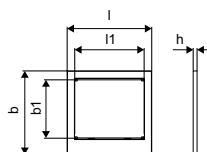

Uponor AQUA PLUS

Uponor Aqua PLUS kapi uks

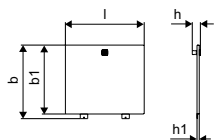

| Art. nr. | Dimension | l mm | b mm | b1 mm | h mm | h1 mm | värvus | 2. pak. | pakend | UOM |
|----------------|--------------|---------|---------|----------|---------|----------|----------|---------|--------|-----|
| 1088753 | A, 320x280mm | 318 | 297 | 278 | 33 | 9 | RAL 9010 | 116 | 1 | tk |
| 1088761 | B, 520x430mm | 518 | 447 | 428 | 33 | 9 | RAL 9010 | | 1 | tk |
| 1088769 | C, 720x430mm | 718 | 447 | 428 | 33 | 9 | RAL 9010 | | 1 | tk |

Uponor Aqua PLUS kapi läbiviik M7

- Läbiviik M7 kappidele
- Kasutatav nii toru-torus paigaldusel kui ka ainult voolutoruga

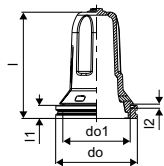

| Art. nr. | Dimension | l mm | l1 mm | l2 mm | do mm | do1 mm | 2. pak. | pakend | UOM |
|----------------|-----------------------|---------|----------|----------|----------|-----------|---------|--------|-----|
| 1063404 | M 25/20-28/23 20-28mm | 52 | 6 | 2 | 40 | 33 | 100 | 10 | tk |
| 1063405 | L 34/28 | 87 | 40 | 2 | 45,5 | 33 | 50 | 2 | tk |
| 1064542 | XL 54/48 32-40mm | 72 | 25 | 2 | 67,4 | 59 | 50 | 2 | tk |

Uponor Aqua PLUS kapi ülevool M7

- Lekke indikaator
- 25/20 hülsstorule
- Vast. NT VVS 129



| Art. nr. | Dimension | d2 mm | 2. pak. | pakend | UOM |
|----------------|-----------|----------|---------|--------|-----|
| 1063462 | 25/20mm | 25/20 | 100 | 10 | tk |

Uponor Aqua PLUS lekkeindikaator M7

- Lekke indikaatori komplekt seinakarbiga
- 25/20 hülsstorule
- Vast. NT VVS 129



| Art. nr. | 2. pak. | pakend | UOM |
|----------------|---------|--------|-----|
| 1062958 | 50 | 1 | tk |

Uponor AQUA PLUS

Uponor Aqua PLUS kollektor Q&E PPM

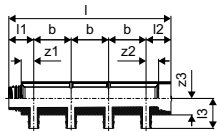

| Art. nr. | Dimension | l | l1 | l2 | l3 | z1 | z2 | z3 | b | väljundid | p | 2. pak. | pakend | UOM |
|----------------|-----------------|-----|----|----|----|----|----|----|----|-----------|------|---------|--------|-----|
| | | mm | mm | mm | mm | mm | mm | mm | mm | - | bar | | | |
| 1047999 | 1" 2X16 c/c50mm | 117 | 33 | 33 | 40 | 17 | 17 | 22 | 50 | 2 | 6+10 | 10 | 1 | tk |
| 1048000 | 1" 3X16 c/c50mm | | | | | | | | | 3 | 6+10 | 8 | 1 | tk |
| 1048001 | 1" 4X16 c/c50mm | | | | | | | | | 4 | 6+10 | 6 | 1 | tk |

Uponor Aqua PLUS kollektor PPM

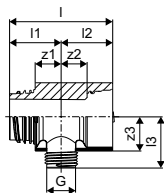

| Art. nr. | Dimension | l | l1 | l2 | l3 | G | z1 | z2 | z3 | väljundid | p | 2. pak. | pakend | UOM |
|----------------|----------------------|----|----|----|----|------|----|----|----|-----------|------|---------|--------|-----|
| | | mm | mm | mm | mm | " | mm | mm | mm | - | bar | | | |
| 1047997 | 1" 1XG1/2"MT c/c50mm | 67 | 33 | 33 | 33 | 1/2" | 17 | 17 | 23 | 1 | 6+10 | 20 | 1 | tk |
| 1047998 | 1" 1XG3/4"MT c/c50mm | | | | | | | | | 1 | 6+10 | 20 | 1 | tk |

Uponor Aqua PLUS kollektori ühendus sirge PPM

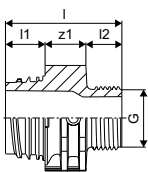

| Art. nr. | Dimension | l | l1 | l2 | G | z1 | p | 2. pak. | pakend | UOM |
|----------------|------------|----|----|----|-----|----|------|---------|--------|-----|
| | | mm | mm | mm | " | mm | bar | | | |
| 1048002 | 1" G3/4"MT | 49 | 17 | 15 | 3/4 | 17 | 6+10 | 20 | 1 | tk |

Uponor Aqua PLUS kollektori nurkühendus PPM

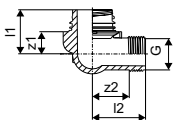

| Art. nr. | Dimension | l1 | l2 | G | z1 | z2 | 2. pak. | pakend | UOM |
|----------------|------------|----|----|-----|----|----|---------|--------|-----|
| | | mm | mm | " | mm | mm | | | |
| 1048003 | 1" G3/4"MT | 33 | 40 | 3/4 | 17 | 28 | 20 | 1 | tk |

Uponor Aqua PLUS kollektori otsakork PPM

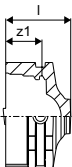
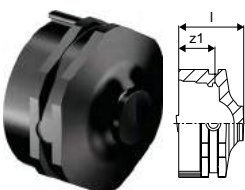

| Art. nr. | Dimension | l | z1 | 2. pak. | pakend | UOM |
|----------------|-----------|----|----|---------|--------|-----|
| | | mm | mm | | | |
| 1048004 | 1"FT | 27 | 15 | 20 | 1 | tk |

Uponor AQUA PLUS

Uponor Aqua PLUS kollektori otsakork õhutusega PPM

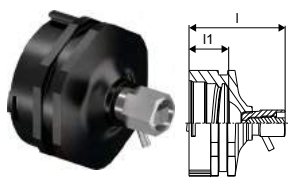

| Art. nr. | Dimension | l mm | l1 mm | 2. pak. | pakend | UOM |
|----------------|-----------|---------|----------|---------|--------|-----|
| 1048005 | 1"FT | 40 | 17 | 20 | 1 | tk |

Uponor Aqua PLUS kollektori kandja PPM



| Art. nr. | l | l1 | l2 | l3 | L | di | z | z1 | b | b1 | b2 | h | h1 | 2. pak. | pakend | UOM |
|----------------|----|----|----|-----|-----|----|----|----|-----|-----|----|----|----|---------|--------|--------|
| | mm | mm | mm | mm | m | mm | mm | mm | mm | mm | mm | mm | mm | | | |
| 1092021 | 36 | 38 | 75 | 150 | 300 | 6 | 14 | 62 | 123 | 102 | 48 | 58 | 32 | 50 | 1 | kompl. |

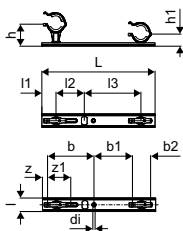

Uponor AQUA PLUS

Uponor Aqua PLUS kollektori otsakork

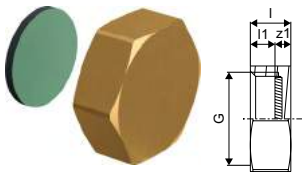

| Art. nr. | Dimension | I mm | I1 mm | G " | z1 mm | 2. pak. | pakend | UOM |
|----------------|-----------|---------|----------|--------|----------|---------|--------|-----|
| 1001337 | 3/4"FT | 12 | 7 | 3/4 | 5 | 250 | 10 | tk |

Uponor Smart Aqua PLUS

Kirjeldus

- Seinakarbid koos põlvedega Uponor PE-Xa torude ja Uponor hülstorude veetihedaks ühendamiseks
- Veetihedus vast. NT VVS 129
- Metallliitmikud: kõrgekvaliteediline DR messing
- Plastiitmikud: PPSU
- PPM kollektorid bajonett-keermega
- Komplektis Q&E rõngas

Kasutusala

- Veetihe paigaldis kahjude vältimiseks võimaliku lekke korral
- Kõikidele paigaldistele, kus nõutakse torude ja hülstorude veetihedat ühendamist

Uponor Smart Aqua PLUS ühenduskarp Q&E M7a DR

- Ühenduskarbi sees Q&E messingpõlv



| Art. nr. | Dimension | d mm | IG " | p bar | uPoints | 2. pak. | pakend | UOM |
|----------------|-------------|---------|---------|----------|---------|---------|--------|-----|
| 1086208 | 16-Rp1/2"FT | 16 | Rp 1/2 | 10 | 50 | 50 | 1 | tk |
| 1086210 | 20-Rp1/2"FT | 20 | Rp 1/2 | 10 | 50 | 50 | 1 | tk |

Uponor Smart Aqua PLUS tihendusmembran M7

- tihendusmembran



| Art. nr. | Dimension | 2. pak. | pakend | UOM |
|----------------|-----------|---------|--------|-----|
| 1062964 | | 1 | tk | |

Uponor Teck hülstoru jätk M7



| Art. nr. | Dimension | I1 mm | I2 mm | I3 mm | k mm | pakend | UOM |
|----------------|-----------|----------|----------|----------|---------|--------|-----|
| 1062956 | 25-28mm | 66 | 66 | 55 | 44 | 1 | tk |

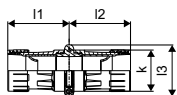

Uponor RS plasttorule

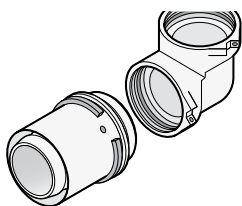

Uponor RS on unikaalne moodulsüsteem püstakute ja magistraalitorustike ehitamiseks. 40 komponendist süsteem võimaldab koostada sadu erinevaid variatsioone

Eelised

- Unikaalne ühendus korpuse ja adapterite vahel
- Kiire ja paindlik: tööriistavaba ühendus, palju variante
- Efektivsem laomajanduse juhtimine
- Muutmise võimalus paigalduse käigus
- Värvkoodid läbimõõdul 16 -110mm



Uponor RS siirdmik PL Q&E

- RS liitmik PEX torudele
- PL messing
- Uponor Q&E rõngad tellida eraldi

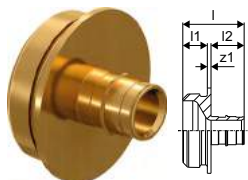

| Art. nr. | Dimension | l mm | l1 mm | l2 mm | z1 mm | p bar | pakend | UOM |
|-----------------|-----------|---------|----------|----------|----------|----------|--------|-----|
| 1047021* | 25-RS2 | 50 | 20 | 27 | 3 | 6+10 | 1 | tk |
| 1047022* | 32-RS2 | 57 | 20 | 34 | 3 | 6+10 | 1 | tk |
| 1047023* | 40-RS2 | 65 | 20 | 42 | 3 | 6+10 | 1 | tk |
| 1047024* | 50-RS2 | 75 | 20 | 52 | 3 | 6+10 | 1 | tk |
| 1047026 | 63-RS2 | 88 | 20 | 65 | 3 | 6+10 | 1 | tk |

Uponor RS siirdmik PL/DR Q&E

- RS liitmik PEX torudele
- DR messing
- Uponor Q&E rõngad tellida eraldi

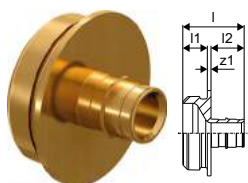

| Art. nr. | Dimension | l mm | l1 mm | l2 mm | z1 mm | p bar | 2. pak. | pakend | UOM |
|-----------------|-----------|---------|----------|----------|----------|----------|---------|--------|-----|
| 1085079* | 75-RS2 | 111 | 20 | 86 | 5 | 6+10 | 6 | 1 | tk |

Uponor RS äärik

- Tinatatud messing
- Ühildub kõikide RS2 või RS3 baasdetailidega
- Äärik PN6/PN16 vast. EN 1092-3
- 4/8 kinnituspoltide ava.

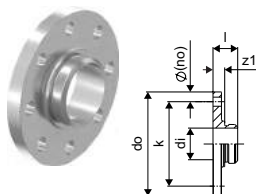

| Art. nr. | Dimension | l mm | l3 mm | di mm | do mm | z1 mm | k mm | p bar | pakend | UOM |
|----------------|------------------|---------|----------|----------|----------|----------|---------|----------|--------|-----|
| 1059398 | RS2-DN65 (PN6) | 38 | 18 | 48,7 | 160 | 18 | 130 | 6 | 1 | tk |
| 1059399 | RS2-DN65 (PN16) | 45 | 25 | 48,7 | 185 | 25 | 145 | 16 | 1 | tk |
| 1059400 | RS3-DN80 (PN6) | 38 | 18 | 78,1 | 190 | 18 | 150 | 6 | 1 | tk |
| 1029129 | RS3-DN80 (PN16) | 45 | | 78,1 | 200 | 25 | 160 | 16 | 1 | tk |
| 1029130 | RS3-DN100 (PN16) | 44 | | 78,1 | 220 | 24 | 180 | 16 | 1 | tk |
| 1059401 | RS3-DN100 (PN6) | 41 | 21 | 78,1 | 210 | 21 | 170 | 6 | 1 | tk |

Uponor RS

Uponor RS lukusti

- plastik
- RS siirdmike lukustamiseks RS baasdetailide külge.



| Art. nr. | Dimension | värvus | pakend UOM | |
|----------------|-----------|-----------------|------------|----|
| 1042921 | RS2 black | must | 10 | tk |
| 1042922 | RS3 grey | Hall (RAL 7015) | 10 | tk |

Uponor põrandaküttetorud

Vaata toru sobivust paigaldussüsteemide kirjeldustes

Uponor Smart põrandküttetoru

- PE-RT põrandkütte toru
- 5-kihiline
- vastab ISO 22391 ja täidab DIN 4726 nõuded hapniku difusiooni takistuse osas
- kasutatav koos Uponor Smart surveliitmikega
- kasutusklass 4
- tööõhk 6 bar temp. 70°C

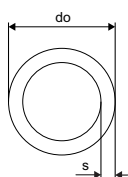

| Art. nr. | Dimension | L m | do mm | s mm | p bar | värvus - | uPoints | 2. pak. | pakend | UOM |
|----------------|-------------|--------|----------|---------|----------|-------------|---------|---------|--------|-----|
| 1086570 | 14x2,0 240m | 240 | 14 | 2,0 | 6 | nat. | 250 | 1680 | 240 | m |
| 1086575 | 16x2,0 240m | 240 | 16 | 2,0 | 6 | nat. | 250 | 1440 | 240 | m |
| 1086576 | 16x2,0 640m | 640 | 16 | 2,0 | 6 | nat. | 700 | 1280 | 640 | m |
| 1086577 | 20x2,0 240m | 240 | 20 | 2,0 | 6 | nat. | 300 | 960 | 240 | m |
| 1086578 | 20x2,0 480m | 480 | 20 | 2,0 | 6 | nat. | 600 | 960 | 480 | m |

Uponor Smart surveliitmik

- Eurokoonus
- Messing
- 3/4" kollektoritele

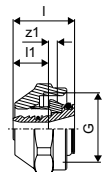

| Art. nr. | Dimension | l mm | l1 mm | G " | z1 mm | p bar | 2. pak. | pakend | UOM |
|----------------|--------------------|---------|----------|--------|----------|----------|---------|--------|-----|
| 1086580 | 14x2,0-G3/4"FTEuro | 23 | 13 | 3/4 | 3 | 6 | 40 | 2 | tk |
| 1086582 | 16x2,0-G3/4"FTEuro | 23 | 13 | 3/4 | 3 | 6 | 40 | 2 | tk |
| 1086583 | 20x2,0-G3/4"FTEuro | 24 | 14 | 3/4 | 3 | 6 | 40 | 2 | tk |

Uponor Smart pressjätk

- Pressjätk
- messing
- Uponor Smart ja Comfort Pipe PLUS torudele

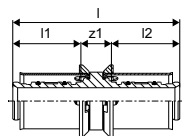

| Art. nr. | Dimension | l mm | l1 mm | l2 mm | z1 mm | p bar | 2. pak. | pakend | UOM |
|----------------|-----------------------|---------|----------|----------|----------|----------|---------|--------|-----|
| 1089646 | 14x2,0-14x2,0 | 52 | 21 | 21 | 9 | 6 | 80 | 10 | tk |
| 1089647 | 16x1,8/2,0-16x1,8/2,0 | 52 | 21 | 21 | 9 | 6 | 80 | 10 | tk |

Uponor põrandaküttetorud

Uponor Comfort Pipe PLUS

Kirjeldus

- Peroksiid ristseotud polüetüleenist (PE-Xa) valmistatud torud vast. EN ISO 15875
- EVOH (etüül vinüül alkohol) kiht hapniku difusiooni takistamiseks vast. DIN 4726
- 5 kihiline
- Välimine PE kiht mehaaniliste vigastuste vältimiseks
- Kasutusklass 4 - Põrandaküte ja madalatemperatuuriline radiaatorküte
- Tuleklass E vastavalt DIN EN 13501-1.

Kasutusala

- Põrandküte ja madalatemperatuuriline radiaatorküte
- Küte
- Max temperatuur: 90°C
- lühiajaline avariitemperatuur 100°C
- Arvestuslik rõhk 6 bar, 70°C

Uponor Comfort Pipe PLUS

- 6/10 bar temp. 90°C/70°C

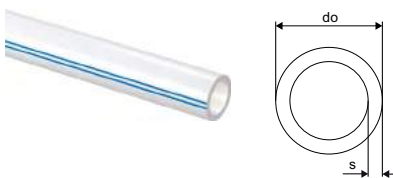

| Art. nr. | Dimension | L m | do mm | s mm | p bar | V l/m | värvus - | uPoints | 2. pak. | pakend UOM |
|----------|-------------|--------|----------|---------|----------|----------|-------------|---------|---------|------------|
| 1062045 | 16x2,0 240m | 240 | 16 | 2,0 | 6 | 0,113 | valge | 700 | 1440 | 240 m |
| 1062046 | 16x2,0 640m | 640 | 16 | 2,0 | 6 | 0,113 | valge | 2600 | 1280 | 640 m |
| 1062884 | 14x2,0 240m | 240 | 14 | 2,0 | 6 | 0,079 | valge | 650 | 1680 | 240 m |
| 1062885 | 14x2,0 960m | 960 | 14 | 2,0 | 6 | 0,079 | valge | 2500 | 1920 | 960 m |

Uponor Comfort Pipe PLUS toru

- 6/8 bar temp. 90°C/70°C

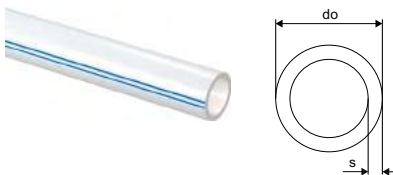

| Art. nr. | Dimension | L m | do mm | s mm | p bar | V l/m | värvus - | uPoints | 2. pak. | pakend UOM |
|----------|-------------|--------|----------|---------|----------|----------|-------------|---------|---------|------------|
| 1009228 | 20x2,0 120m | 120 | 20 | 2 | 6 | 0,200 | valge | 600 | 840 | 120 m |
| 1009230 | 20x2,0 240m | 240 | 20 | 2,0 | 6 | 0,200 | valge | 1000 | 960 | 240 m |
| 1009231 | 20x2,0 480m | 480 | 20 | 2 | 6 | 0,200 | valge | 1850 | 960 | 480 m |

Uponor Comfort Pipe PLUS toru

- 6 bar temp. 90°C

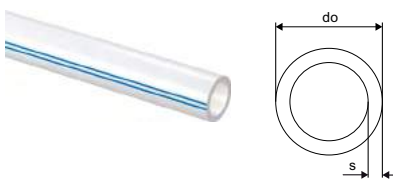

| Art. nr. | Dimension | L m | do mm | s mm | p bar | värvus - | uPoints | 2. pak. | pakend UOM |
|----------|-------------|--------|----------|---------|----------|-------------|---------|---------|------------|
| 1062888 | 25x2,3 220m | 220 | 25 | 2,3 | 6 | valge | 900 | 440 | 220 m |
| 1062889 | 25x2,3 300m | 300 | 25 | 2,3 | 6 | valge | 1200 | 600 | 300 m |
| 1063907 | 25x2,3 640m | 640 | 25 | 2,3 | 6 | valge | 2400 | | 640 m |

Uponor Vario surveiliitmik PEX

- Eurokoonus
- Messing



| Art. nr. | Dimension | l mm | l1 mm | G " | z1 mm | 2. pak. | pakend UOM |
|----------|------------------------|---------|----------|--------|----------|---------|------------|
| 1065283 | 14x2,0-G3/4"FTEuro | 23 | 13 | 3/4 | 3 | 25 | 1 tk |
| 1065284 | 16x1,8/2,0-G3/4"FTEuro | 23 | 13 | 3/4 | 3 | 25 | 1 tk |
| 1065290 | 20x1,9/2,0-G3/4"FTEuro | 24 | 14 | 3/4 | 3 | 25 | 1 tk |

Uponor põrandaküttetorud

Uponor MLCP RED

Kirjeldus

- Hapniku difusioonikindel komposiitтору (PE-RT - sidekiht - pikisuunas keevitatud alumiinium - sidekiht - PE-RT)
- Materjali klass B2 vastavalt DIN 4102.

Kasutusala

- Max. püsiv tööõhk: 4 bar
- Max.püsiv töötemperatuur 60°C.

Uponor MLCP RED toru

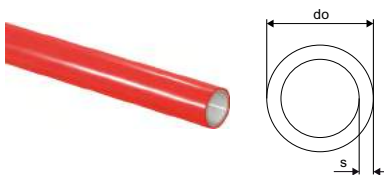

| Art. nr. | Dimension | L m | do mm | s mm | uPoints | 2. pak. | pakend UOM |
|----------|-------------|--------|----------|---------|---------|---------|------------|
| 1047001 | 14x1,6 200m | 200 | 14 | 1,6 | 300 | 2600 | 200 m |
| 1047002 | 14x1,6 500m | 500 | 14 | 1,6 | 800 | 3500 | 500 m |
| 1047003 | 16x2,0 200m | 200 | 16 | 2,0 | 400 | 2600 | 200 m |
| 1047004 | 16x2,0 500m | 500 | 16 | 2,0 | 1000 | 3500 | 500 m |

Uponor Vario surveliitmik MLCP RED

- messing
- 3/4" eurokoonus sisekeermega liitmik Uponor MLC punase PK/jahutuse torude ühendamiseks Uponor kollektoritega.
- Rõngastihendi värvus: punane



| Art. nr. | Dimension | l mm | l1 mm | l2 mm | z1 mm | 2. pak. | pakend UOM |
|----------|-----------------|---------|----------|----------|----------|---------|------------|
| 1000117 | 14x1,6-3/4"Euro | 27 | 17 | 8 | 3 | 80 | 10 tk |

Uponor MLCP RED pressliitmik

- MLCP RED toru jätk
- Tinatatud messing
- Fikseeritud presshülssidega, värvkood stoppervõrude ja lekkeindikaatoriga.
- Pressitav ilma faasimiseta

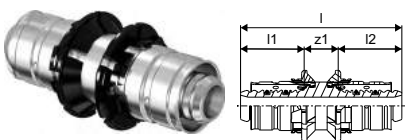

| Art. nr. | Dimension | l mm | l1 mm | l2 mm | z1 mm | 2. pak. | pakend UOM |
|----------|---------------|---------|----------|----------|----------|---------|------------|
| 1048272 | 14x1,6-14x1,6 | 54 | 21 | 21 | 11 | 80 | 10 tk |

Uponor Multi paindetugi galv teras

- Tsingitud teras
- Paindetugi 90°

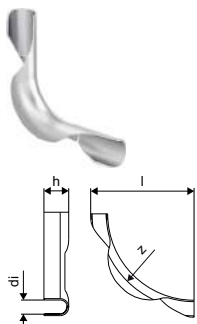

| Art. nr. | Dimension | l mm | di mm | z mm | h mm | r mm | värvus | pakend UOM |
|----------|-----------|---------|----------|---------|---------|---------|------------|------------|
| 1009004 | -16 | 100 | 16,3 | 63 | 15 | 63 | galv steel | 10 tk |
| 1009233 | -20 | 132 | 20 | 102 | 20 | 102 | galv steel | 20 tk |
| 1009006 | -25 | 170 | 25,5 | 134 | 22 | 134 | galv steel | 10 tk |
| 1001231 | -34 | 210 | 32 | 137 | 28 | 137 | galv steel | 2 tk |

Uponor Nubos

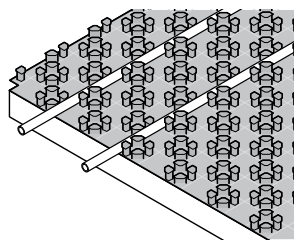

Uponor Nubos on välja töötatud spetsiaalselt põrandakütte/-jahutuse süsteemidele. Paneelid paigaldatakse põrandale tsement või anhüriid tasandussegu alla.

Eelised

- Lihtne: õhuke, optimaalselt sobivad komponendid
- Kasutatav nii komposiit- kui ka PE-Xa torudega (läbim 14/16)
- Kestev ja kvaliteetne



Kirjeldus

- Nubos paigalduspaneel 14 - 16 mm torude fikseerimiseks.
- Torude võimalikud paigaldussammud: 5,5 11 16,5 22 27,5 33 cm
- **Sobivad torud : Comfort Pipe Plus, Smart , MLCP RED**
- EN 13501-1 tuleklass: klass E
- Standardne süttivus, ehitusmaterjal klass B2, vast. DIN 4102

Kasutusala

- põrandaküttele ja -jahutusele
- kasutatakse koos betoon ja anhüriidsegudega
- ilma isolatsioonita

Sertifitseerimine

- DIN CERTCO: 7F335-F; 7F336-F; 7F337-F; 7F338-F

Uponor Nubos paigalduspaneel

- Paigalduspaneel plastikust ilma isolatsioonita



| Art. nr. | Dimension | s MN/m ² | l mm | b mm | h1 mm | A m ² | värvus - | Area | uPoints | 2. pak. | pakend | UOM |
|----------------|-----------|------------------------|---------|---------|----------|---------------------|-------------|-------|---------|---------|--------|----------------|
| 1016703 | 14-16mm | - | 1447 | 900 | 18 | 1.25 | RAL 9017 | 1.302 | 100 | 140 | 10 | m ² |

Uponor Tacker

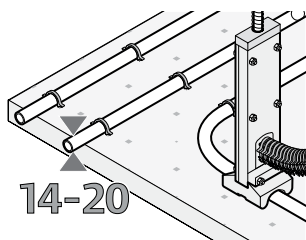

Tacker klambrid toru kinnitamiseks isolatsiooniplaadile. Soovitatav on kasutada lamineeritud EPS plaate. Sobib kõikide põrandakütte- torude kinnitamiseks.

Eelised

- **Paindlik:** Torude kinnitamiseks klambritega isolatsiooniplaadile
- **Sobib erinevatele põrandasegudele**
- **Universaalsed toruklambrid torudele 14 – 20mm**
- **Lihtne paigaldus:** ergonomiline klambripaigaldiga



Kirjeldus

- Tacker põrandaküttesüsteem.
- Torude kinnitusklambrid torudele 14-20 mm
- **Sobivad torud :** Comfort Pipe Plus, Smart , MLCP RED

Kasutusala

- põrandaküttele ja -jahutusele
- sobilik nii betoon kui ka anhidriidsegudega paigaldistes

Sertifitseerimine

- DIN CERTCO: 7F077-F, 7F185-F, 7F216-F, 7F278-F

Uponor Tacker tacker klamber, lühike

- Tacker kinnitusklamber
- Kasutatakse koos Uponor Tacker klambripaigaldiga

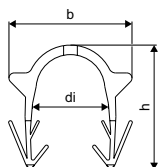

| Art. nr. | Dimension | di mm | b mm | h mm | 2. pak. | pakend UOM |
|----------------|----------------|----------|---------|---------|---------|------------|
| 1086528 | 14-20mm h=35mm | 22,1 | 36 | 36 | 6000 | 300 tk |

Uponor Tacker Tacker kinnitusklamber standard

- Tacker kinnitusklamber
- Kasutatakse koos Uponor Tacker klambripaigaldiga

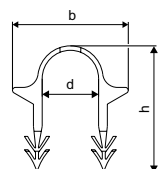

| Art. nr. | Dimension | di mm | b mm | h mm | pakend UOM |
|----------------|----------------|----------|---------|---------|------------|
| 1086529 | 14-20mm h=40mm | 19 | 39 | 43 | 1000 tk |

Uponor Tacker

Uponor Tacker toru kinnitusklamber, pikk

- Tacker kinnitusklambrid
- Kasutatakse koos Uponor Tacker klambripaigaldiga

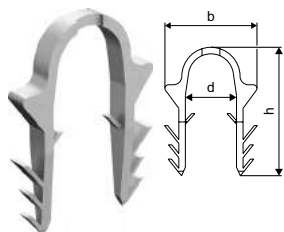

| Art. nr. | Dimension | do mm | b mm | h mm | pakend UOM |
|----------------|-----------|----------|---------|---------|------------|
| 1086530 | 55mm | 21,5 | 37 | 54 | 300 tk |

Uponor Fix kinnitusprofiil

- kinnitusprofiil torudele 14 ja 16 mm
- c-c 50mm

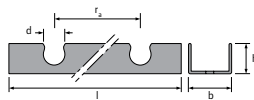
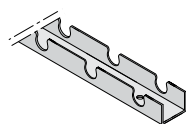

| Art. nr. | Dimension | d mm | l mm | b mm | h mm | c/c mm | värvus | pakend UOM |
|----------------|-------------------|---------|---------|---------|---------|-----------|-----------------|------------|
| 1005498 | 14mm c/c50mm 2,5m | 14 | 2500 | 38 | 17 | 50 | Hall (RAL 7015) | 25 m |

Uponor Fix kinnitusprofiil kleepribaga

- 14-20mm torude kinnitusprofiil
- c-c 50mm
- iseliimuva põhjaga



| Art. nr. | Dimension | l mm | b mm | h mm | c/c mm | 2. pak. | pakend UOM |
|----------------|--------------------|---------|---------|---------|-----------|---------|------------|
| 1000018 | 14-20mm c/c50mm 1m | 1000 | 50 | 27 | 50 | 600 | 100 m |

Uponor Classic

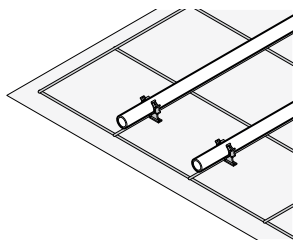

Uponor Classic on klassikaline põrandkütte ja -jahutuse lahendus elamuehituses ja ärihoonetes. Sobib kasutamiseks ka suurte koormustega põrandates.

Eelised

- Klassikaline paindlik, kiire ja lihtne paigaldus
- Võimalik kasutada erinevaid isolatsioonimaterjale
- Kindel: pikaajaline, läbiproovitud süsteem



Kirjeldus

- Classic süsteemi puhul kinnitatakse torud soojus- ja sammumüra isolatsiooni peale.
- Torude kinnitus armatuurvõrgu külge sidumistraadi või kaablisidemetega
- **Sobivad torud : Comfort Pipe Plus, Smart , MLCP RED**

Kasutusala

- põrandaküttele ja -jahutusele
- kasutatakse koos betoon ja anhidriidsegudega

Sertifitseerimine

- DIN CERTCO: 7F004-F; 7F371-F; 7F421-F

Uponor Classic sidumistraat

- terastraat torude kinnitamiseks armatuurvõrgule
- kasutamiseks koos Uponor sidumiskonksuga



| Art. nr. | Dimension | l mm | pakend | UOM |
|----------------|------------|---------|--------|-----|
| 1009222 | 150x1,25mm | 250pcs | 1 | tk |

Uponor Siccus 14

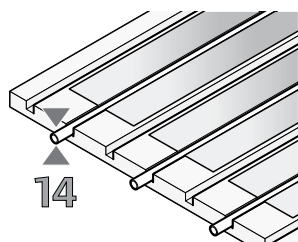

Uponor Siccus 14 võimaldab pörandakütte rajamist ilma valutöödeta. Ideaalne lahendus laagidel pörandade puhul. Kasutatav ka seinakütte rajamiseks.

Eelised

- Kaalult kerge pörandakonstruktsiooni rajamiseks
- Kiire paigaldus: kipsplaadist pinnakiht koheselt koormatav
- Kuivpaigalduseks: veevaba, ei vaja kuivamisaega
- Universaalne: kasutatav 14 mm MLC RED või Comfort Pipe Plus torudega



Kirjeldus

- Siccus pörandaküttesüsteem koosneb EPS isolatsiooniplaadist ja alumiiniumist soojusjaotusplaatidest.
- EN 13501-1 tuleklassifikatsioon: klass E.
- Kasutusklass vast. DIN 4108-10: DEO dh, WI
- Koormustaluvus vast. EN 1991-1-1 = 7,5kN/m²
- Torude paigaldussamm c-c 150mm
- **Sobivad torud : 14 mm Comfort Pipe Plus, MLCP RED**

Kasutusala

- Pörandaküte ja -jahutus
- Kuivpaigaldus

Sertifitseerimine

- DIN CERTCO: 7F008-F, 7F009-F, 7F332-F

Uponor Siccus 14 paneel

- Soontega paigaldusplaat
- EPS survetugevus: = 150 kPa
- R=0.622 m²K/W
- Plaadi pindala 1,25 m²

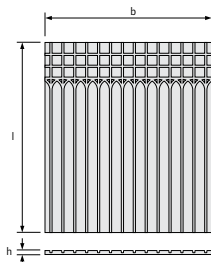

| Art. nr. | Dimension | G kN/m ² | ND | l mm | R-arv m ² K/W | b mm | h mm | A m ² | uPoints | 2. pak. | pakend UOM |
|----------|--------------------------------|------------------------|----|---------|-----------------------------|---------|---------|---------------------|---------|---------|---------------------|
| 1005485 | EPS 150kPa 14mm 1197x1050x25mm | 75 | 25 | 1197 | 0,622 | 1050 | 25 | 1.25 | 200 | 100 | 12,5 m ² |

Uponor Siccus 14 soojusjaotusplaat

- alumiiniumist soojusjaotusplaat kasutamiseks Uponor kuivpaigaldusega PK süsteemides torule 14mm
- eelstantsitud murdekohad
- materjali kulu = 5.6 tk/m² (c-c150mm)

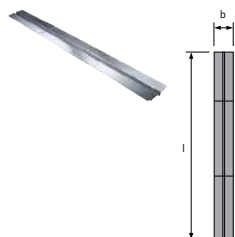

| Art. nr. | Dimension | l mm | b mm | 2. pak. | pakend UOM |
|----------|----------------------|---------|---------|---------|------------|
| 1005486 | 14mm 1180x120x0,45mm | 1180 | 120 | 768 | 48 tk |

Uponor Siccus 14

Uponor Siccus 14 PS soonelõikur

- EPS plaatide kuumlõikur
- 230V, 50/60Hz
- soonte lõikamiseks 14mm torudele



| Art. nr. | Dimension | TP V | 2. pak. | pakend | UOM |
|----------------|-----------|---------|---------|--------|-----|
| 1006290 | 14mm 230V | 230 | 20 | 1 | tk |

Uponor Siccus 20

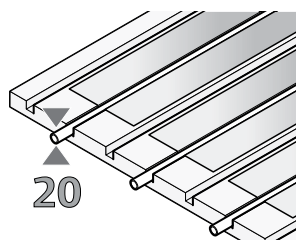

Uponor Siccus 20 võimaldab põrandakütte rajamist ilma valutöödeta. Ideaalne lahendus laagidel põrandade puhul. Kasutatav ka seinakütte rajamiseks.

Eelised

- Kaalult kerge põrandakonstruktsiooni rajamiseks
- Kiire paigaldus: kipsplaadist pinnakiht koheselt koormatav
- Kuivpaigalduseks: veevaba, ei vaja kuivamisaega
- Universaalne: kasutatav 20 mm Comfort Pipe Plus torudega



Kirjeldus

- Siccus põrandküttesüsteem koosneb EPS isolatsiooniplaadist vast. EN 13163 ja alumiiniumist soojusjaotusplaatidest.
- EN 13501-1 tuleklassifikatsioon: klass E.
- Koormustaluvus vast. EN 1991-1-1 = 7,5kN/m²
- Torude paigaldussamm c-c 300 mm
- **Sobivad torud : 20 mm Comfort Pipe Plus, Smart**

Kasutusala

- põranda- ning seinaküte ja -jahutus
- kuivpaigaldus

Uponor Siccus 20 paneel

- Soontega paigaldusplaat
- Paksus 30mm
- EPS survetugevus: = 200 kPa
- Kulu: 1,1 plaati/ m²



| Art. nr. | Dimension | l mm | c/c mm | b mm | h mm | ND A m ² | 2. pak. | pakend | UOM |
|----------------|------------------------|---------|-----------|---------|---------|------------------------|---------|--------|-----|
| 1034347 | EPS 20mm 1200x790x30mm | 1200 | 300 | 790 | 30 | 30 0,948 | 25 | 5 | tk |

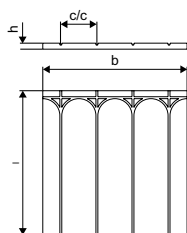

Uponor Multi soojusjaotusplaat

- Alumiiniumist soojusjaotusplaat
- Kasutatakse koos 20 mm torudega, paigaldussamm 300mm
- kulu: 2,5 plaati/m²



| Art. nr. | Dimension | l mm | s mm | b mm | 2. pak. | pakend | UOM |
|----------------|-------------------------|---------|---------|---------|---------|--------|-----|
| 1009132 | 20mm 1150x280x0,55mm AL | 1150 | 22,0 | 280 | 280 | 40 | tk |

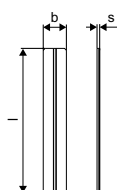

Uponor Magna

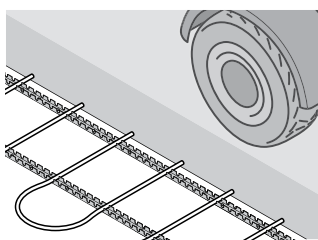

Uponor Magna on tööstusliku põrandakütte süsteem. Betoonpõrandatele. Toru kinnitatakse armatuurvõrgule.

Eelised

- Lihtne ja paindlik: Paigalduseks on vaja vaid väike hulk komponente
- Kuluefektiivne: lühike tasuvusaeg, praktiliselt hooldevaba
- Töökindel ja pikaealine



Kirjeldus

- Tööstuslik põrandaküttesüsteem
- Kuni 20 kontuuri ühe kollektori kohta
- Kandurite arv vastavalt kollektori pikkusele
- Väljundite vahekaugus 100 mm

Kasutusala

- Suurte tootmis- ja äripindade põrandaküttesüsteem
- Betoonpõrandatesse
- Kuni 20 küttekontuuri

Uponor Magna kinnitusprofiil

- kinnitusprofiil torudele 20 ja 25 mm
- c-c 50mm

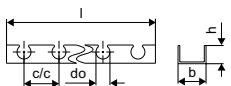

| Art. nr. | Dimension | l mm | do mm | c/c1 mm | b mm | ND värvus | 2. pak. | pakend UOM |
|-----------------|-----------------|---------|----------|------------|---------|-----------|---------|------------|
| 1005290* | 25mm c/c50mm 3m | 3000 | 25 | 50 | 60 | - | 1320 | 30 m |

Uponor Fit surveliitmik väliskeere

- Messing
- Põrandaküttetoru ühendamiseks kollektoriga

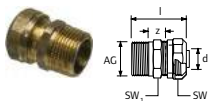

| Art. nr. | Dimension | d mm | AG " | l mm | SW mm | z mm | 2. pak. | pakend UOM |
|----------------|----------------|---------|---------|---------|----------|---------|---------|------------|
| 1005295 | 25x2,3-R3/4"MT | 25 | R 3/4 | 50 | 37/27 | 15 | 100 | 10 tk |
| 1005298 | 25x2,3-R1"MT | 25 | R 1 | 53 | 37/34 | 20 | 100 | 10 tk |

Uponor Magna

Uponor Fit surveliitmik sisekeere

- Messing
- Põrandaküttetoru ühendamiseks kollektoriga



| Art. nr. | Dimension | d mm | IG " | l mm | SW mm | z mm | 2. pak. | pakend UOM |
|----------|-----------------|---------|---------|---------|----------|---------|---------|------------|
| 1005297 | 25x2,3-Rp3/4"FT | 25 | Rp 3/4 | 35 | 37/31 | 8 | 100 | 10 tk |

Uponor Magna põhikomplekt

- Komplektis: 2 lühikest ja pikka klambrit, 2 messingist täiteventiili, 2 termomeetrit 0 - 60°C, manomeeter, 2 otsakorki, 2 lametihendiga pöördmutriga ühendusotsa 1 1/2" SK , paigaldustarvikud: (8 kruvi 6x60mm, 8 tüüblit 8x40mm, 2 lametihendit 44x32x2)

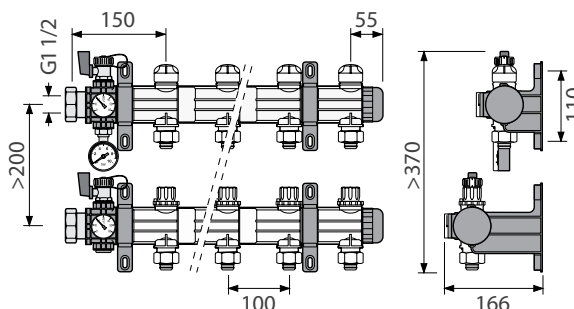

| Art. nr. | Dimension | pakend UOM |
|----------|-----------|------------|
| 1045815 | K1 | 1 tk |

Uponor Magna kollektori moodul

- Pealevoolumoodul eelseadeventiiliga
- Tagasivoolumoodul korgiga ventiili sulgemiseks,
- Tagasivoolumoodulile võimalik paigaldada Uponor aiam
- Kütteringi ühendus G3/4 eurokoonusega (ei ole komplektis)



| Art. nr. | Dimension | p bar | VN m³/h | 2. pak. | pakend UOM |
|----------|-----------|----------|------------|---------|------------|
| 1045814 | G3/4 | 6 | 8,0 | 10 | 1 tk |

Uponor Magna kollektori moodul

- Pealevoolumoodul eelseadeventiilidega
- Tagasivoolumoodul korgiga kütteringi sulgemiseks
- Tagasivoolu moodulile võimalik paigaldada Uponor aiam
- Surveleitmikud kütteringi ühendamiseks PE-Xa 25x2,3 toruga on komplektis



| Art. nr. | Dimension | p bar | VN m³/h | 2. pak. | pakend UOM |
|----------|-----------|----------|------------|---------|------------|
| 1045813 | dim 25 | 6 | 8,0 | 10 | 1 tk |

Uponor Magna

Uponor SPI Magna kuulkraan, komplekt

- Messing



| Art. nr. | Dimension | pakend | UOM |
|----------------|------------|--------|-----|
| 1030135 | 2x G 1 1/2 | 1 | tk |

Uponor Magna kandurikomplekt

- Komplektis: 2 lühikest klambrit, 2 pikka klambrit, paigaldustarvikud: 8x kruvi 6x60mm, 8x tüübel 8x40mm
- Kandurite koguvajadus 6-9 kütteringile 3 kandurit, 10-14 kütteringile 4 kandurit ,
- 15-19 kütteringile 5 kandurit ja 20 kütteringile 6 kandurit



| Art. nr. | pakend | UOM |
|----------------|--------|-----|
| 1045816 | 1 | tk |

Uponor SPI Magna vooluhulgaregulaator

- Sulgemisfunktsiooniga
- Klaaskiuga armeeritud polüamiid



| Art. nr. | 2. pak. | pakend | UOM |
|----------------|---------|--------|-----|
| 1030134 | 20 | 1 | tk |

Uponor Multi

Uponor Multi

Kirjeldus

- Põrandakütte erinevate süsteemide paigaldustarvikud ja komponendid

Kasutusala

- Põrandakütte ja jahutussüsteemid

Uponor Multi kinnitusprofiil

- kinnitusprofiil torudele 20 ja 25 mm
- c-c 50mm

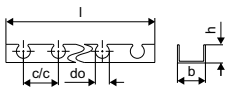

| Art. nr. | Dimension | l mm | do mm | c/c1 mm | b mm | ND | värvus | 2. pak. | pakend | UOM |
|----------|-----------------|---------|----------|------------|---------|----|----------|---------|--------|-----|
| 1005358 | 20mm c/c50mm 3m | 3000 | 20 | 50 | 40 | 26 | RAL 7042 | 30 | 3 | m |

Uponor Multi kile

- PE-kile. Paigaldatakse soojusisolatsiooni peale
- läbipaistev

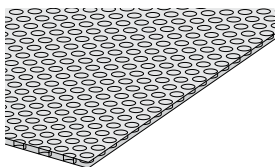

| Art. nr. | Dimension | s mm | G kN/m ² | ND | L m | B | A m ² | pakend | UOM |
|----------|-----------|---------|------------------------|----|--------|---|---------------------|--------|----------------|
| 1000017 | 4mm 60x1m | 4,0 | 15 | 4 | 60 | 1 | 60 | 60 | m ² |

Uponor Multi ääreriba kilega

- Ääreriba, vast. DIN 18560. Materjal polüetüleen. Välisküljel olev kleepriba tagab ääreriba ja isolatsiooni vahelise ühenduse

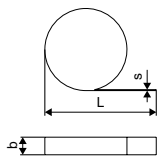

| Art. nr. | Dimension | l mm | L m | s mm | b mm | värvus | pakend | UOM |
|----------|-----------|---------|--------|---------|---------|--------|--------|-----|
| 1000079 | 150x8mm | 50000 | 50 | 8 | 150 | sinine | 200 | m |

Uponor Multi kaitsehülss

- Materjal PE-LD, külglõhega. Kuni 20 mm PK torude kaitseks paisumisvuukides



| Art. nr. | Dimension | s mm | l mm | b mm | pakend | UOM |
|----------|------------------|---------|---------|---------|--------|-----|
| 1000082 | max 20mm 300x5mm | 5,0 | 300 | 80 | 30 | tk |

Uponor Multi

Uponor Multi betoonilisand

- betoonilisand; parandab segu kvaliteeti
- ainult tsementsegudele
- suurendab platilisust ja vee peetust
- materjali kulu 7 cm segukihile: 0.2 l/m²
- minimaalne katva segukihi paksus: 30 mm koormusel 2 kN/m² või 45 mm koormusel 5 kN/m²
- kõvastumisaeg: 21 päeva



| Art. nr. | Dimension | Vol. l | KA d | 2. pak. | pakend | UOM |
|----------------|------------|--------|------|---------|--------|-----|
| 1000084 | VD 450 20L | 20,00 | 21 | 480 | 20 | l |

Uponor Vario M

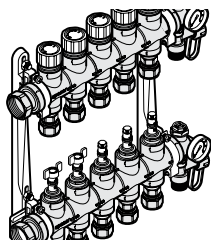

Uponor Vario M on kõrgekvaliteediline plastkollektor. Kasutatakse põrandakütte ja -jahutussüsteemides. Väljundid G 3/4 eurokoonus sobivad kõikide Uponor põrandaküttetorude ühendamiseks.

Eelised

- Paigaldusvalmis – eelkoostatud kollektorid 2-15 küttekontuurile
- Lihtne paigaldada – peale- ja tagasivoolumoodulid teineteise suhtes nihutatud
- Määrumiskindlad vooluhulgaregulaatorid; vahetatavate klaasidega
- Sobivad ka suurtele kütte- ja jahutuspindadele elu- ja ärihoonetes
- Pumbasõlmede ja soojamõõtjate ühendamise võimalus



Kirjeldus

- Lattkollektor
- Integreeritud ventiilidega
- Parem- või vasakpoolse ühendusega 1" (lametihend)
- Pealevoolul vooluhulga regulaatorid tasakaalustamiseks ja sulgemiseks
- Tagasivoolul korkidega varustatud ventiil
- Öhueraldus-, täite- ja tühjendusventiilid
- Küttekontuuri ühendus: G3/4" eurokoonus
- Väljundite samm: 50 mm
- Materjal: klaasfiibriga armeeritud polüamiid

Kasutusala

- Põrandaküttele ja -jahutusele
- Max. rõhk: 6 bar, 60°C
- Sobilikud ajamid:
 - 1087778 (24V)
 - 1087763 (230V)

Uponor Vario M kollektor vooluh reg FM

Uponor Vario M kollektor vooluhulga regulaatoriga FM



| Art. nr. | Dimension | väljundid p - bar | l mm | pakend | UOM |
|----------|---------------|----------------------|---------|--------|-----|
| 1085944 | 2X G3/4 Euro | 2 | 6 210 | 1 | tk |
| 1085945 | 3X G3/4 Euro | 3 | 6 260 | 1 | tk |
| 1085946 | 4X G3/4 Euro | 4 | 6 310 | 1 | tk |
| 1085947 | 5X G3/4 Euro | 5 | 6 360 | 1 | tk |
| 1085948 | 6X G3/4 Euro | 6 | 6 410 | 1 | tk |
| 1085949 | 7X G3/4 Euro | 7 | 6 460 | 1 | tk |
| 1085950 | 8X G3/4 Euro | 8 | 6 510 | 1 | tk |
| 1085951 | 9X G3/4 Euro | 9 | 6 560 | 1 | tk |
| 1085952 | 10X G3/4 Euro | 10 | 6 610 | 1 | tk |
| 1086250 | 11X G3/4 Euro | 11 | 6 700 | 1 | tk |
| 1086251 | 12X G3/4 Euro | 12 | 6 750 | 1 | tk |

Uponor SPI Vario M vooluhulga regulaator

varuosa Vario M kollektorile



| Art. nr. | Dimension | pakend | UOM |
|----------|-----------|--------|-----|
| 1085956* | 0-5l/min | 1 | tk |

Uponor Vario S

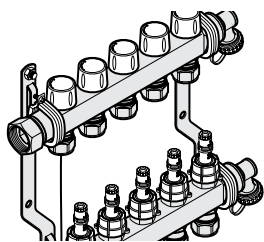

Uponor Smart S on roostevabast terasest põrandkütte kollektor nii elu- kui tööstuslikesse ruumidesse. Väljundid G 3/4 eurokoonus. Sobib kõikide Uponor põrandaküttetorudega.

Eelised

- Paigaldusvalmis – eelkoostatud kollektorid 2-15 küttekontuurile
- Lihtne paigaldada – peale- ja tagasivoolu moodulid teineteise suhtes nihutatud
- Määrumiskindlad vooluhulga regulaatorid vahetatavate klaasidega
- Sobivad ka suurtele kütte- ja jahutuspiindadele elu- ja ärihoonetes
- Pumbasõlmede ja soojamõõtjate ühendamise võimalus



Kirjeldus

- Roostevabast terasest
- Integreeritud ventiilidega
- Pealevoolu parem- või vasakpoolne ühendus
- Integreeritud õhueraldid, täite- ja tühjendusotsad peale- ja tagasivoolul
- Küttekontuuride ühendus G3/4" eurokoonus
- Ühendusotste samm 50 mm
- Telgede vahe 200 mm

Kasutusala

- Põrandaküttele ja -jahutusele
- Sobivus ajamitega:
- 1087778 (24V)
- 1087763 (230V)
- Max. rõhk: 6 bar, 60°C

Uponor Vario S kollektor FM

- Vooluhulga regulaatoritega tasakaalustamiseks ja sulgemiseks
- Tagasivoolu klappidel korgid

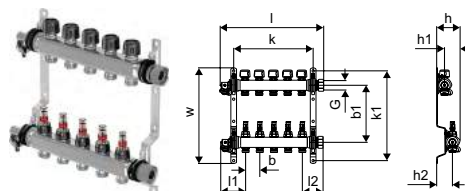

| Art. nr. | Dimension | l | l1 | l2 | G | G1 | b | b1 | b2 | h | h1 | h2 | k | k1 | w | väljundid | p | uPoints | 2. pak. | pakend | UOM |
|----------|-------------|-----|----|----|---|-----|----|-----|-----|----|----|----|-----|-----|-----|-----------|-----|---------|---------|--------|-----|
| | | mm | mm | mm | " | " | mm | mm | mm | mm | mm | mm | mm | mm | mm | - | bar | | | | |
| 1086538 | 2X3/4 Euro | 210 | 87 | 73 | 1 | 3/4 | 50 | 215 | 215 | 75 | 30 | 50 | 135 | 336 | 357 | 2 | 6 | 100 | 1 | tk | |
| 1086539 | 3x3/4 Euro | 260 | 87 | 73 | 1 | 3/4 | 50 | 215 | 215 | 75 | 30 | 50 | 185 | 336 | 357 | 3 | 6 | 120 | 1 | tk | |
| 1086540 | 4x3/4 Euro | 310 | 87 | 73 | 1 | 3/4 | 50 | 215 | 215 | 75 | 30 | 50 | 235 | 336 | 357 | 4 | 6 | 140 | 1 | tk | |
| 1086541 | 5x3/4 Euro | 360 | 87 | 73 | 1 | 3/4 | 50 | 215 | 215 | 75 | 30 | 50 | 285 | 336 | 357 | 5 | 6 | 160 | 1 | tk | |
| 1086542 | 6x3/4 Euro | 410 | 87 | 73 | 1 | 3/4 | 50 | 215 | 215 | 75 | 30 | 50 | 335 | 336 | 357 | 6 | 6 | 180 | 1 | tk | |
| 1086543 | 7X3/4 Euro | 460 | 87 | 73 | 1 | 3/4 | 50 | 215 | 215 | 75 | 30 | 50 | 385 | 336 | 357 | 7 | 6 | 210 | 1 | tk | |
| 1086544 | 8x3/4 Euro | 510 | 87 | 73 | 1 | 3/4 | 50 | 215 | 215 | 75 | 30 | 50 | 435 | 336 | 357 | 8 | 6 | 230 | 1 | tk | |
| 1086545 | 9x3/4 Euro | 560 | 87 | 73 | 1 | 3/4 | 50 | 215 | 215 | 75 | 30 | 50 | 485 | 336 | 357 | 9 | 6 | 250 | 1 | tk | |
| 1086546 | 10x3/4 Euro | 610 | 87 | 73 | 1 | 3/4 | 50 | 215 | 215 | 75 | 30 | 50 | 535 | 336 | 357 | 10 | 6 | 270 | 48 | 1 | tk |
| 1086547 | 11x3/4 Euro | 660 | 87 | 73 | 1 | 3/4 | 50 | 215 | 215 | 75 | 30 | 50 | 585 | 336 | 357 | 11 | 6 | 300 | 48 | 1 | tk |
| 1086548 | 12x3/4 Euro | 710 | 87 | 73 | 1 | 3/4 | 50 | 215 | 215 | 75 | 30 | 50 | 635 | 336 | 357 | 12 | 6 | 320 | 48 | 1 | tk |

Uponor SPI Vario Vario S vooluhulga regulaator

varuosa Vario S kollektorile



| Art. nr. | l | b | pakend | UOM |
|--------------------|-----|-----|--------|-----|
| | mm | mm | | |
| NEW 1087608 | 100 | ø24 | 10 | tk |

Uponor Vario

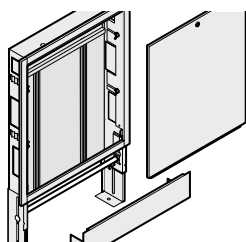

- kontrollereid
- soojusmõõtjaid
- ventile ja ühendustarvikuid

Uponor Vario kollektorkapid on osa põrandaküttesüsteemist.

Võimaldavad paigaldada kõiki vajalikke süsteemi

komponente:

- kollektoreid
- pumbasõlmi

Eelised

- Uponor kollektorite ja komponentide (pumbasõlmed, automaatika jne...paigaldamiseks)
- Reguleeritav kappide kõrgus ja sügavus
- Uks ja raam eraldi pakendis, tolmukindel
- Reguleeritavad paigaldussiinid
- Kollektorite vertikaalne või horisontaalne ühendus
- Vaba ala juhtseadmetele (kollektori kohal)
- Jalgade reguleerimise võimalus vastavalt põranda konstruktsioonile



Uponor Vario kollektori kapp IW

- **Seinasisene** komplektne kapp raami ja uksega
- Sügavus: 110mm, suurendatav kuni 150mm
- Reguleeritav kõrgus: 730 - 930mm
- Ukse konstruktsiooni kõrgus: maks. 200mm
- Materjal: tsingitud teras
- Raam ja uks pulbervärvitud, valge (RAL 9010)
- Lukustatav uks

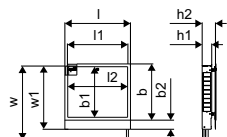

NEW
NEW
NEW
NEW

| Art. nr. | Dimension | l mm | l1 mm | l2 mm | b mm | b1 mm | b2 mm | h1 mm | h2 mm | w mm | w1 mm | 2. pak. | pakend | UOM |
|----------------|----------------|---------|----------|----------|---------|----------|----------|----------|----------|---------|----------|---------|--------|-----|
| 1093473 | 550x730x110mm | 605 | 550 | 539 | 650 | 572 | 108 | 110 | 150 | 930 | 730 | 27 | 1 | tk |
| 1093474 | 700x730x110mm | 755 | 700 | 689 | 650 | 572 | 108 | 110 | 150 | 930 | 730 | 20 | 1 | tk |
| 1093475 | 850x730x110mm | 905 | 850 | 839 | 650 | 572 | 108 | 110 | 150 | 930 | 730 | 18 | 1 | tk |
| 1093476 | 1000x730x110mm | 1055 | 1000 | 989 | 650 | 572 | 108 | 110 | 150 | 930 | 730 | 13 | 1 | tk |

Uponor SPI Vario silindr. lukk, 2 võtit

- Vario kappidele
- Metall, nikeldatud



NEW

| Art. nr. | pakend | UOM |
|----------------|--------|-----|
| 1093554 | 1 | tk |

Uponor Vario

Uponor Vario seinapealne kapp NT

- Seinapealne kollektorkapp
- Tsingitud teras
- Valge
- Lukustatav

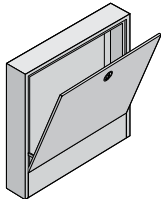

| Art. nr. | Dimension | l mm | l1 mm | b mm | h mm | w mm | värvus - | 2. pak. | pakend | UOM |
|----------------|-----------|---------|----------|---------|---------|---------|-------------|---------|--------|-----|
| 1046996 | 555x160mm | 555 | 504 | 618 | 160 | 810 | RAL 9010 | | 1 | tk |
| 1046997 | 705x160mm | 705 | 654 | 618 | 160 | 810 | RAL 9010 | 10 | 1 | tk |
| 1046998 | 785x160mm | 785 | 734 | 618 | 160 | 810 | RAL 9010 | | 1 | tk |
| 1046999 | 950x160mm | 950 | 898 | 618 | 160 | 810 | RAL 9010 | | 1 | tk |

Uponor Vario seadeventiilid

- Kollektorite tasakaalustamiseks ja sulgemiseks
- Tsooni juhtimiseks Uponor M30x1.5mm VK ajamiga
- Korpus - messing
- Käepidemed - polüamiid
- Maksimaalne katserõhk: 10 bar (vesi)

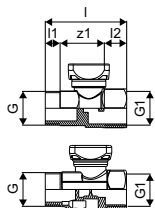

| Art. nr. | Dimension | l mm | l1 mm | l2 mm | G " | G1 " | z1 mm | 2. pak. | pakend | UOM |
|----------------|-----------|---------|----------|----------|--------|---------|----------|---------|--------|--------|
| 1005100 | G1 - Rp1 | 80 | 15 | 22 | 1 | 1 | 44 | 10 | 1 | kompl. |

Uponor Vario kuulkraan

- Nikeldatud messing
- Kollektori sulgemiseks



| Art. nr. | Dimension | AG | IG | 2. pak. | pakend | UOM |
|----------------|-----------|----|----|---------|--------|--------|
| 1059132 | NP G1-G1 | 1 | 1 | 10 | 1 | kompl. |

Uponor Vario

Uponor Vario SM ühendus G1

- Nikeldatud messing
- Kollektori horisontaalseks ühendamiseks G1
- Andurite ühendused M10x1 peale- ja tagasivoolul



| Art. nr. | Dimension | G | G1 | l | l1 | l2 | h | h1 | z1 | z2 | pakend | UOM |
|----------|-----------|---|----|----|-----|----|----|----|-----|----|--------|--------|
| | | " | " | mm | mm | mm | mm | mm | mm | mm | | |
| 1090728 | G1" 130mm | 1 | 1 | - | 315 | 80 | 42 | 36 | 300 | 65 | 1 | kompl. |

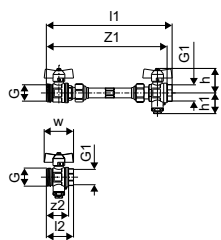

Uponor Vario SM ühendus G1

- Nikeldatud messing
- Kollektori vertikaalseks ühendamiseks
- Andurite ühendused M10x1 peale- ja tagasivoolul



| Art. nr. | Dimension | G | G1 | l | l1 | l2 | h | h1 | z1 | pakend | UOM |
|----------|-----------|---|----|-----|-----|-----|----|-----|-----|--------|--------|
| | | " | " | mm | mm | mm | mm | mm | mm | | |
| 1090729 | G1" 130mm | 1 | 1 | 325 | 160 | 110 | - | 280 | 265 | 1 | kompl. |

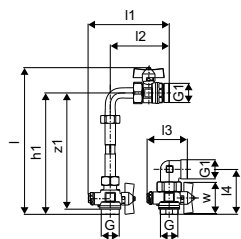

Uponor Vario

Uponor Vario SM ühendus G3/4

- Nikeldatud messing
- Kollektorite horisontaalseks ühendamiseks G 3/4"
- Andurite ühendused M10x1 peale- ja tagasivoolul



| Art. nr. | Dimension | G | G1 | I1 | I2 | h | h1 | z1 | z2 | | |
|----------------|-------------|---|-----|-----|----|----|----|-----|----|--|------------|
| | | " | " | mm | mm | mm | mm | mm | mm | | |
| 1090730 | G3/4" 110mm | 1 | 3/4 | 265 | 70 | 42 | 36 | 250 | 55 | | |
| | | | | | | | | | | | pakend UOM |
| | | | | | | | | | | | 1 kompl. |

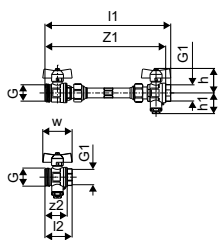

Uponor Vario SM ühendus G3/4

- Nikeldatud messing
- Kollektorite vertikaalseks ühendamiseks G 3/4"
- Andurite ühendused M10x1 peale- ja tagasivoolul



| Art. nr. | Dimension | G | G1 | I | I1 | I2 | h1 | z1 | | |
|----------------|-------------|---|-----|-----|-----|-----|-----|-----|--|------------|
| | | " | " | mm | mm | mm | mm | mm | | |
| 1090731 | G3/4" 110mm | 1 | 3/4 | 285 | 150 | 110 | 240 | 225 | | |
| | | | | | | | | | | pakend UOM |
| | | | | | | | | | | 1 kompl. |

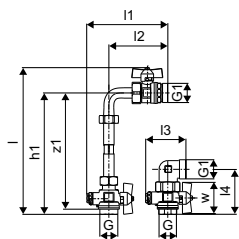

Uponor Smatrix Move PRO

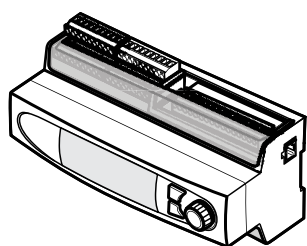

Paindlik ja mitmekülgne **mitme tsooni pealevoolu-temperatuuri juhtimisautomaatika**.

Erinevate sise- ja välisrakenduste juhtimine (kiirgusküte, -jahutus, soe tarbevesi) ühe kontrolleri abil.

Olenevalt tarkvarast (SD kaart) võimaldab töötada kütte või kütte ja jahutuse süsteemides.

Ühildub Smatrix Base PRO süsteemiga.

Integreeritav hoone keskujuhtimise süsteemiga (KNX moodul)

Eelised

- Mitmeotstarbeline pealevoolutemperatuuri kontroller
- Juhib kuni 4 pealevoolukontuuri üheaegselt
- Automaatne kütte/ jahutuse ümberlülitus
- Kompensatsiooniviiside valik
- Jää ja lume ning pinnase sulatussüsteemide juhtimine

Uponor Smatrix Move PRO kontrolleri X-159

- Mitme tsooni pealevoolutemperatuuri kontroller
- Sisekliima juhtimiseks ärihoonetes
- Kiirgusküte ja jahutus
- Soe tarbevesi

Funktsioonid:

- Küte, jahutus ja soe tarbevesi
- Kuni 4 küttesooni või 3 küttesooni ja 1 jahutustsoon
- Kuni 2 lumesulatustsooni
- Eraldi töötamiseks (juhtmetega anduritega) või integreerituna Smatrix Base PRO süsteemiga
- Integreeritav BMS süsteemiga ModBus või KNX liidese abil
- Lihtne paigaldada ja konfigureerida
- Mikro SD kaart tarkvara uuenduseks ja seadete kloonimiseks

Komplektis:

- Uponor Smatrix Move PRO kontrolleri X-159
- Kütte rakenduse pakett (mikro SD kaart, kleebised, juhendid)
- Kütte ja jahutuse rakenduse pakett (mikro SD kaart, kleebised, juhendid)
- Kiirpaigaldusjuhendid

- Lisavastavus: EAC
- Ühendusprotokoll: Modbus-RTU (alluv), Uponor Smatrix Base PRO bus
- Toitepinge: 230V 50Hz / 125mA
- Töötemperatuur: 0°C ... +50°C
- Kaitseklass: IP20
- ERP klass: III (1.5%) / VII (3.5%) ruumitermostaadiga



| Art. nr. | TP V | l mm | b mm | d mm | uPoints | 2. pak. | pakend | UOM |
|----------|---------|---------|---------|---------|---|---------|--------|-----|
| 1087155* | 230 | 213,5 | 93,3 | 90 |  400 | 10 | 1 | tk |

Uponor Smatrix Move PRO

Uponor Smatrix Move PRO sulatuskomplekt S-152 + S-158

- Sulatuskütte komplekt Uponor Smatrix Move PRO kontrolleri X-159
- Juhib 0-10V modulaarjuhtimisega 3-tee ventiili või 2-tee ventiili
- 3 töörežiimi: stop, sulatus, meltaway
- 1 kaitserežiim: soojusvaheti kaitse

Komplektis:

- 3x Uponor Smatrix Move peale- ja tagasivoolu andurit S-152
- 2x Uponor Smatrix Move PRO lume&jää andurit S-158 (pinnase andur koos vutlariga)
- Kiirjuhend koos ühendusskeemidega.
- Vastavus: EAC



| Art. nr. | d mm | L m | h mm | uPoints | 2. pak. | pakend | UOM |
|-----------------|---------|--------|---------|---------|---------|--------|--------|
| 1087158* | | | | 400 | | 1 | kompl. |
| 1087156 | 63 | 25 | 78 | 100 | 5 | 1 | tk |

Uponor Smatrix Move PRO temp. andur S-155

- Ruumitemperatuuriandur
- Sisetsoonide kütte ja jahutuse juhtimiseks välistemperatuuri muutuse kompensatsiooniga
- 2-juhtmeline ühendus Uponor Smatrix Move PRO kontrolleri X-159

- Vastavus: EAC
- Anduri tüüp: NTC10
- Temperatuurivahemik: 0°C ... +60°C
- Kaitseklass: IP20



| Art. nr. | TP V | l mm | b mm | d mm | uPoints | 2. pak. | pakend | UOM |
|-----------------|---------|---------|---------|---------|---------|---------|--------|-----|
| 1087159* | 24 | 80 | 85 | 30 | 100 | 10 | 1 | tk |

Uponor Smatrix Move PRO niiskuseandur S-157

- Ruumi temperatuuriandur niiskuseanduriga
- Mõõdab suhtelist niiskust kondensatsiooni vältimiseks
- Ainult jahutuse või kütte ja jahutuse tsoonidele
- 3-sooneline ühendus Uponor Smatrix Move PRO kontrolleri X-159.
- Vastavus: EAC
- Niiskuse mõõtevahemik: 0-100%
- Täpsus: <2%RH
- Toitepinge: 24V / 50-60 Hz
- Töötemperatuur: -10°C ... +50°C
- Kaitseklass: IP20



| Art. nr. | TP V | l mm | b mm | d mm | uPoints | pakend | UOM |
|-----------------|---------|---------|---------|---------|---------|--------|-----|
| 1087160* | 24 | 80 | 85 | 30 | 100 | 1 | tk |

Uponor Smatrix Move PRO

Uponor Smatrix Move PRO kond. komplekt S-159

- Kondensatsiooni komplekt
- Kaitseb kiirgusjahutussüsteeme kondensatsiooni eest
- Peatab ajutiselt jahutuse toimimise, kui kondensaadi tekkimise oht on suur
- Ühendatakse Uponor Smatrix Move PRO kontrolloriga X-159
- 24V, IP20

Komplektis:

- Torule paigaldatav niiskuse andur
- Konverter
- Lühijuhend koos ühenduskeemidega



| Art. nr. | TP | I | b | d | uPoints | 2. pak. | pakend | UOM |
|-----------------|----|----|----|----|---|---------|--------|--------|
| | V | mm | mm | mm | | | | |
| 1087165* | 24 | 85 | 60 | 36 |  100 | 10 | 1 | kompl. |

Uponor Smatrix Move

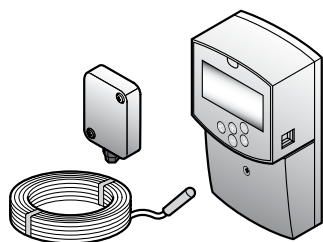

Pealevoolutemperatuuri juhtimine küttesüsteemides. Seadistab pealevoolu temperatuuri vastavalt sise- ja välistemperatuurile.

Eelised

- Komfort ja Eco programmeeritud graafikud
- Olekuinfo reaalajas
- Pumba loogika nii iseseisvaks tööks kui ka kombineerituna Uponor ruumi automaatikaga
- Lisavõimalus: sekundaarkütte/sooja tarbevee kontuuri juhtimine



Kirjeldus

- Komfort ja Eco programmeeritud graafikud
- Olekuinfo reaalajas
- Pumba loogika nii iseseisvaks toimimiseks või koos Uponor ruumi automaatikaga
- Erinevad kompensatsiooni võimalused
- Lisavõimalus: sekundaar kütte/sooja tarbevee juhtimine
- Lisavõimalus: sulatuskütte lisamine
- Lisavõimalus: kondensatsiooni kaitse

Kasutusala

- pealevoolu vee temperatuuri juhtimine

Sertifitseerimine

- CE

Uponor Smatrix Move kontrolleri H X-157 juhtmega

- **Pealevoolu temperatuuri kontrolleri**
- Juhtimisrežiim: ainult kütte, välistemperatuuri järgi

Funktsioonid:

- Segamisventiili juhtimine
- 9 eelprogrammeeritud graafikut (nädala programm)
- 4 vabalt programmeeritavat graafikut, autonoomse pumba loogika
- Autonoomse pumba loogika
- Uponor Smatrix Base või Wave kontrolleri koos töötava pumba loogika
- Pealevoolu-, sise- ja välistemperatuuri info reaalajas
- Segamisventiili oleku info reaalajas
- Jooksva päeva graafiline info (komfort ja alandatud temperatuur) reaalajas
- Sooja tarbevee valmistamine ja boileri juhtimine
- Kuumaveeringlus
- Pealevoolu temperatuuri reguleerimine kuni 100°C
- 2 pingestatud üldotstarbelist väljundit, 2 üldotstarbelist sisendit
- Turvakontaktiga termostaat, 230V segamismootor

Komplektis:

- Uponor Smatrix Move kontrolleri
- Peale-/tagasivoolu andur
- Välisandur
- Kaitseklass: IP30 II
- Värvus: tumehall



| Art. nr. | l mm | b mm | d mm | 2. pak. | pakend UOM |
|----------------|---------|---------|---------|---------|------------|
| 1071693 | 160 | 86 | 53 | 4 | 1 kompl. |

Uponor Smatrix Move

Uponor SPI Smatrix Move PLUS antenn A-155 Radio

- varuantenn Uponor Smatrix Move kontrolleri
- tagab juhtmevaba ühenduse Uponor Smatrix Wave termostaatidega

Komplektis:

- Uponor Smatrix Move antenn
- ühenduskaabel
- paigaldustarvikud

- vastavus: EAC



| Art. nr. | Frequency MHz | l mm | b mm | d mm | 2. pak. | pakend | UOM |
|-----------------|---------------|------|------|------|---------|--------|-----|
| 1071676* | 868 | 200 | 23 | 15 | 21 | 1 | tk |

Uponor Smatrix Move pealev/tagasiv andur S-152

- Peale-/tagasivoolu andur
- Mõõdab peale- või tagasivoolu temperatuuri
- Anduri tüüp: NTC 10 kΩ, 25 °C
- Kaabli pikkus: 3m
- Kaitseklass: IP68 II



| Art. nr. | L m | pakend | UOM |
|----------------|-----|--------|-----|
| 1071661 | 3 | 1 | tk |

Uponor SPI Fluvia Move PLUS ajam 230V

- Ajam 230V
- 3- punkti juhtimine



| Art. nr. | TP V | 2. pak. | pakend | UOM |
|----------------|------|---------|--------|-----|
| 1084560 | 230 | 16 | 1 | tk |

Uponor Smatrix väliandur S-1XX

- mõõdab välistemperatuuri
- komplektis paigaldustarvikud
- kasutatakse koos Uponor Smatrix Wave/Move kontrolleri
- lisavõimalus juhtmevaba ühendus koos Uponor Smatrix Wave termostaadiga Public
- kaitseklass: IP55
- anduri tüüp: NTC 10kOhm, 25°C
- värvus: helehall



| Art. nr. | 2. pak. | pakend | UOM |
|-----------------|---------|--------|-----|
| 1071671* | 45 | 1 | tk |

Uponor Fluvia Move/Move PLUS

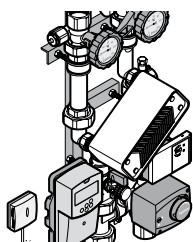

Uponor Fluvia Move eelkoostatud pumbasõlmed tagavad soovitud pealevoolu ja ringluse kiirgusküttesüsteemides.

Fluvia Move pumbasõlmed sisaldavad kõiki vajalikke ühenduskomponente.

Eelised

- Komplektne eelkoostatud sõlm
- Sisaldavad kõiki vajalikke komponente
- Pealevoolutemperatuuri juhtimine Uponor Smatrix Move kontrolloriga
- Kinnitusklambrid seinale või Uponor kollektorkappi paigaldamiseks
- Lihtne menüü



Kirjeldus

- Uponor Smatrix Move automaatikaga komplekteeritud pumbasõlm
- Välistemperatuuri anduriga (paigaldatakse kohapeal)
- Pealevoolu vee temperatuuri andur
- Ajamiga juhtiv 3-tee seguventiil
- Proportsionaalne rõhu reguleerimine
- Kütte/ jahutuse juhtimise laiendamise võimalus
- Uponor Smatrix termostaadiga T-168 (1086984) ja Uponor Smatrix antenniga (1071676)

Kasutusala

- Välistemperatuurist sõltuv pealevoolu vee temperatuuri juhtimine
- Max. primaartemperatuur 90°C
- Max. sekundaarrõhk: 6 bar, 60°C

Uponor Fluvia Move pumbasõlm MPG-10-A-W

- Pump WILO Yonos Para 15/6: Q: 0,1-2,5 m³/h, H: 6-2,4 m, EEI 0,17
- Kuulkraan + pealevoolu tasakaalustusventiil
- Väljuvad ühendused G1 (VK)
- Parem- või vasakukäeline ühendus kollektoriga



OUT

| Art. nr. | Flow Rate l/h | kvs m³/h | TP V | P W | p bar | uPoints | 2. pak. | pakend | UOM |
|-----------------|------------------|-------------|---------|--------|----------|---------|---------|--------|-----|
| 1078306* | 0,1-2,5 | 4,3 | 230 | 45 | 6 | 2800 | 30 | 1 | tk |

Uponor Fluvia Move/Move PLUS

Uponor Fluvia pumbasõlm MPG-10-B-W

- 3T-ventiiliga
- Vajab lisaks ajamit ja automaatikaplokki
- Pump (WILO Yonos Para 15/6): Q: 0,1-2,5 m³/h, H: 6-2,4 m, EEI 0,17
- Kuulkraan + pealevoolu tasakaalustusventiil
- Väljuvad ühendused G1 (VK)
- Parem- või vasakukäeline ühendus kollektoriga



| Art. nr. | Flow Rate l/h | kvs m³/h | TP V | P W | p bar | uPoints | 2. pak. | pakend | UOM |
|---------------------|------------------|-------------|---------|--------|----------|---------|---------|--------|-----|
| OUT 1078307* | 0,1-2,5 | 4,3 | 230 | 45 | 6 | 1100 | 30 | 1 | tk |

Uponor Fluvia Move pumbasõlm CPG-15-A-W

- Eraldiseisev pumbasõlm automaatikaga
- Pump (WILO Yonos Para 25/6): Q: 0,1-2,5 m³/h, H: 6-2,4 m, EEI 0,17
- Kuulkraan + pealevoolu tasakaalustusventiil
- Väljuvad ühendused G1 (VK)
- Parem- või vasakukäeline ühendus kollektoriga



| Art. nr. | Flow Rate l/h | kvs m³/h | TP V | P W | p bar | uPoints | 2. pak. | pakend | UOM |
|---------------------|------------------|-------------|---------|--------|----------|---------|---------|--------|-----|
| OUT 1078308* | 0,1-2,5 | 6,3 | 230 | 45 | 6 | 3200 | 18 | 1 | tk |

Uponor Fluvia pumbasõlm CPG-15-B-W

- Eraldiseisev pumbasõlm automaatikata
- Vajab lisaks ajamit ja automaatikaplokki
- Pump (WILO Yonos Para 25/6): Q: 0,1-2,5 m³/h, H: 6-2,4 m, EEI 0,17
- Kuulkraan + pealevoolu tasakaalustusventiil
- Väljuvad ühendused G1 (VK)
- Parem- või vasakukäeline ühendus kollektoriga



| Art. nr. | Flow Rate l/h | kvs m³/h | TP V | P W | p bar | uPoints | 2. pak. | pakend | UOM |
|--------------------|------------------|-------------|---------|--------|----------|---------|---------|--------|-----|
| OUT 1078309 | 0,1-2,5 | 6,3 | 230 | 45 | 6 | 1450 | 18 | 1 | tk |

Uponor Fluvia Move/Move PLUS

Uponor Smatrix Move 3-punkti segamismootor 230V

- 230V segamismootor
- 3-punkti juhtimine
- Uponor Smatrix Move kontrolleri



| Art. nr. | TP V | pakend UOM | |
|----------------|---------|------------|----|
| 1002357 | 230 | 1 | tk |

Uponor Move PLUS soojusvahetiga pumbasõlm

Kirjeldus

- Pump: Q: 0,1-2,5 m³/h, H: 6-2,4 m, EEI 0,17
- Soojusvahetiga
- Primaarühendus Rp1 1/4 (SK)
- Sekundaarühendused kuulkraanid lametihendiga G1 (SK)

Kasutusala

- Maakütte kollektori hüdrauliliseks eraldamiseks
- Vabajahutseks
- Max. primaarpoole temperatuur 90°C
- Max. sekundaarpoole rõhk: 6 bar, 60°C

Uponor Fluvia Move PLUS pumbasõlm EPG-6-A-W

- Soojusvahetiga
- Vajalikud automaatika tarvikud:
- Uponor Smatrix termostaat T-168
- Uponor Smatrix antenn (1071676)



| Art. nr. | Flow Rate l/h | kvs m ³ /h | TP V | P W | p bar | Q kW | 2. pak. | pakend UOM | |
|----------------|------------------|--------------------------|---------|--------|----------|---------|---------|------------|----|
| 1078310 | 0,1-2,5 | 7 | 230 | 45 | 6 | 1-6 | 8 | 1 | tk |

Uponor Fluvia T

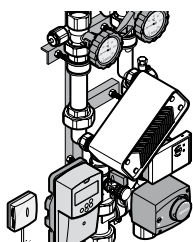

Fluvia T pumbagrupid sisaldavad kõiki toimimiseks vajalikke komponente. Konstantse pealevoolutemperatuuri tagamiseks. (Kuni 2 kontuuri)

Eelised

- Eelkoostatud pumbagrupid: hüdrauliliselt katsetatud
- Sisaldavad kõiki vajalikke komponente
- Pealevoolutemperatuuri juhtimine termostaatpea või ajamiga
- Kinnitusklambrid paigaldamiseks seinale või kollektorikappi



Kirjeldus

- Integreeritud Grundfos pump: Q: 0,1 - 0,4 m³/h, H: 0,2 - 1,1 m, Phyd< 1W
- Parem- või vasakukäeline paigaldus
- Õhueraldajaga
- Sekundaarpoole temperatuurivahemik 20-50°C
- Tasakaalustusventiil
- Küttekontuuri ühendus 3/4" eurokoonusega
- Primaarpoole ühendus surveliitmikud 15 mm vasktorule

Kasutusala

- Põrandakütte juhtimiseks väikestes tsoonides
- Max. primaartemperatuur 90°C
- Max. rõhk: 6 bar, 60°C

Uponor Fluvia T Push-12 TH-G

- Kapillaartermostaadiga pumbagrupp 12-28°C
- Maksimaalse pealevoolutemperatuuri piirajaga 50°C



NEW

| Art. nr. | l | l1 | l2 | G | G1 | b | b1 | b2 | h | h1 | w | 2. pak. | pakend | UOM |
|----------|-----|----|-----|-----|-----|----|----|----|----|----|-----|---------|--------|-----|
| | mm | mm | mm | " | " | mm | mm | mm | mm | mm | mm | | | |
| 1095127 | 332 | 38 | 129 | 5/8 | 3/4 | 40 | 65 | 65 | 84 | 42 | 240 | 60 | 1 | tk |

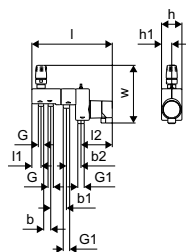

Uponor Fluvia T

Uponor Fluvia T pumbagrupp Push-12 AC-G

- **Ajamiga 230V** pumbagrupp(saab käskluse väliselt automaatselt või termostaadilt)
- Maksimaalse pealevoolutemperatuuri piiraja 50°C



NEW

| Art. nr. | 2. pak. | pakend | UOM |
|----------------|---------|--------|-----|
| 1095128 | 60 | 1 | tk |

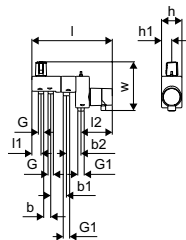

Uponor Fluvia toruhargmik

- Messing
- PUSH-12 pumbasõlme laiendamiseks 2 kütteringile



| Art. nr. | Dimension | l mm | c/c mm | 2. pak. | pakend | UOM |
|----------------|------------------|---------|-----------|---------|--------|--------|
| 1005675 | 2xG3/4-3/4" Euro | 50 | 40 | 50 | 1 | kompl. |

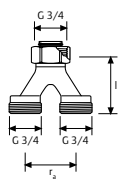

Uponor Fluvia T

Uponor Fluvia T pumbagrupp PUSH

Kirjeldus

- Pump WILO Yonos Para 15/6 RKA: Q: 0,1-2,5 m³/h, H: 6-2,4 m EEI 0,17
- Kapillaaranduriga termostaat 20-55°C
- G1 (VK) ühendamiseks Uponor põrandakütte kollektoritega

Kasutusala

- Ühendamiseks Uponor kollektoritega, paigaldus seinale või kollektorkappi
- max. primaartemperatuur 90° C
- max. sekundaartemperatuur 55° C
- max. 6 bar

Uponor Fluvia T pumbasõlm Push-23-B-W mitme kontuuriga põrandakütte

- Maksimaalne võimus: **10 kW**
- kvs arv: 1,2 m³/h
- pealevoolu kontrollitakse **kapillaarsensoriga termostaadiga** (konstantne pealevoolutemperatuur)
- ühendus otse kollektori külge



OUT

| Art. nr. | Flow Rate l/h | kvs m ³ /h | TP V | P W | p bar | Q kW | uPoints | pakend | UOM |
|----------|------------------|--------------------------|---------|--------|----------|---------|---------|--------|-----|
| 1078304 | 0,1-2,5 | supply 1,2 / return 2,7 | 230 | 45 | 6 | 10 | 900 | 1 | tk |

Uponor Fluvia T

Uponor Smart pumbagrupp

Kirjeldus

- Termostaatventiili ja kapillaartermostaadiga 20-55°C
- Toiteühendused Rp 3/4
- Põrandkütte ühendused G1, lametihendiga
- Seadeventiil

Kasutusala

- Konstantse pealevoolu temperatuuri juhtimisega
- Max. pealevoolu temperatuur 90°C
- Max. põrandkütte rõhk: 6 bar, 50°C

Uponor Smart pumbasõlm mitme kontuuriga põrandaküttele ca 10 kw

- Pump Q: 0,1-2,4 m³/h, H: 4 m EEI ≤0,2
- Pumbasõlm ühendamiseks kollektoriga.
- **Omatoimeline kapillaartermostaat (20-55°C) konstantse pealevoolu temperatuuri seadmiseks.**
- Pealevoolu termostaatventiil kvs 1,2 m³/h
- Tagasivoolu tasakaalustusventiil kvs 2,7 m³/h
- ühendus kollektoriga G1 (vk)
- lametihendiga ühendused G1-G1 kuulkraanide ühendamiseks.
- max sekundaartemperatuur 55°
- max rõhk 6 bar



OUT

Art. nr.

1086563

uPoints



500

2. pak.

45

pakend UOM

1

tk

Uponor pumbasõlmede varuosad

Uponor SPI Fluvia T Grundfos pump Push-12

- Uponor Fluvia T pumbagrupidete PUSH-12 AC-G / WL-G / TH-G / CH-G



NEW

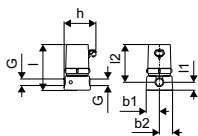

| Art. nr. | 2. pak. | pakend | UOM |
|----------------|---------|--------|-----|
| 1095132 | 20 | 1 | tk |

Uponor SPI Fluvia Wilo Yonos Para pump

varuosa PUSH 23 pumbagrupidete



| Art. nr. | Dimension | TP V | pakend | UOM |
|----------------|-----------------|---------|--------|-----|
| 1059854 | RS15/6 G1 130mm | 230 | 1 | tk |

Uponor SPI Fluvia T Push 23 termostaat Push-23

varuosa Push-23 Push-23-C pumbagrupidete



| Art. nr. | pakend | UOM |
|----------------|--------|-----|
| 1063461 | 1 | tk |

Uponor Smatrix Wave

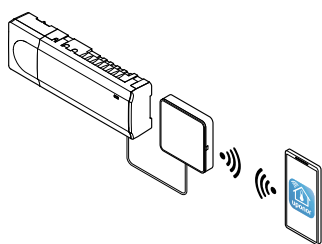

Smatrix automaatikasüsteem võimaldab nii automaatset tasakaalustust kui ka muid energiasäästu tagavaid võimalusi kiirguskütte- ja jahutussüsteemides. Süsteemi saab kaugjuhtida Smatrix rakenduse abil.

Eelised

- Kaugjuurdepääs Smatrix rakenduse abil
- Automaatne kütteringide tasakaalustamine
- Kiire paigaldus, minimaalne kaabeldus
- Lihtne seadistada
- Lai valik võimalusi energia efektiivseks kasutamiseks



Kirjeldus

■ juhtmevabadele termostaatidele

- kuni 4 kontrollerit juhitavad ühe ühendusmooduliga R-208
- automaatne tasakaalustus optimeerib energiakasutust ja mugavust
- ühe kontrolleriga on võimalik ühendada kuni 6 ruumi termostaati ja 8 ajamit (24V)
- pumba ja katla lülitusreleed
- ajamite ja pumba sundkäivitus
- by-pass möödaviik
- suhtelise niiskuse kontrollimine
- põrandakütte/-jahutuse ja lagijahutuse juhtimisvõimalus
- kontrolleri toitepinge 230V
- ajamite toitepinge 24VAC
- ajami võimsus: 0.2A (0.4A käivitusel)
- andmete säilitamine pilves, tarkvara uuendused interneti teel
- lokaalne (Wi-Fi) või kaugjuurdepääs (vajalik interneti ühendus) ühendusmooduli R-208 ja Smatrix äpi kaudu
- ajutine wi-fi ühenduspunkt juurdepääsuks (kui kohalik wi-fi ei ole saadaval) (R-208)
- nutikodu ökosüsteemi integratsioon (Amazon Alexa, Google Home) (R-208)
- mitme erineva paigalduse (hoone) juhtimine (R-208)
- kolmanda osapoole juurdepääs kaugtoeks (R-208)
- varasemate perioodide trendide analüüs Uponor Smatrix Pulse rakenduse abil (R-208)
- taimeri programmeerimine (R-208)
- mugavusseadistused (R-208)
- pealevoolu diagnostika (R-208)

Kasutusala

- kiirguskütte ja jahutuse juhtmevaba ruumi temperatuuri juhtimine
- termostaatide seadevahemik: +5°C ... +35°C

Sertifitseerimine

- CE / EAC

Uponor Smatrix Wave

Uponor Smatrix Wave stardipakett Pulse S

- juhtmevabad termostaadid
- kasutusvalmis hooldevaba pörandakütteautomaatika stardipakett
- laiendatav vastavalt vajadusele
- kaitseklass: II IP20
- värvus: valge

Komplektis:

- 1x Uponor Smatrix Pulse ühendusmoodul com R-208
- 1x Uponor Smatrix Wave kontrolleri Pulse X-265 6X
- 3x Uponor Smatrix Wave termostaati D+RH Style T-169
- esmapaigalduse juhend, ohutusjuhendid
- paigaldustarvikud

| Art. nr. | TP V | Frequency MHz | uPoints | 2. pak. | pakend | UOM |
|----------------|---------|------------------|---------|---------|--------|--------|
| 1093284 | 230 | 868 | 700 | 3 | 1 | kompl. |

NEW



Uponor Smatrix Wave stardipakett Pulse L

- juhtmevabad termostaadid
- kasutusvalmis hooldevaba pörandakütteautomaatika stardipakett
- laiendatav vastavalt vajadusele
- kaitseklass: II IP20
- värvus: valge

Komplektis:

- 1x Uponor Smatrix Pulse ühendusmoodul com R-208
- 2x Uponor Smatrix Wave kontrolleri Pulse X-265 6X
- 5x Uponor Smatrix Wave termostaat D+RH Style T-169
- esmapaigalduse juhend, ohutusjuhendid
- paigaldustarvikud

| Art. nr. | TP V | Frequency MHz | uPoints | 2. pak. | pakend | UOM |
|----------------|---------|------------------|---------|---------|--------|--------|
| 1093287 | 230 | 868 | 700 | 2 | 1 | kompl. |

NEW



Uponor Smatrix Wave

Uponor Smatrix Wave Pulse X-265+R-208 6X

- kasutusvalmis komplekt: kontrolleri ja ühendusmoodul R-208
- **juhtmevabadele termostaatidele**
- laiendatav
- kaitseklass: II IP20
- värvus: valge

Komplektis:

- 1x Uponor Smatrix Pulse com R-208
- 1x Uponor Smatrix Base kontrolleri Pulse X-265 6X
- esmapaigalduse juhend, ohutusjuhend
- paigaldustarvikud

| Art. nr. | TP V | Frequency MHz | uPoints | 2. pak. | pakend | UOM |
|--------------------|---------|------------------|---------|---------|--------|--------|
| NEW 1093024 | 230 | 868 | 700 | 3 | 1 | kompl. |



Uponor Smatrix Pulse com Pulse com R-208

- ühendusmoodul
- **sama moodul nii juhtmega kui ka juhtmevabadele kontrolleri/termostaatidele**
- loob ühenduse Uponor Smatrix Pulse süsteemi, Uponor Smatrix Pulse rakenduse ja Uponor pilve vahel

Ühilduvus:

- Uponor Smatrix Base kontrolleri Pulse X-245 Bus 6X
- Uponor Smatrix Wave kontrolleri Pulse X-265 6X

- toide: RJ45 kaabel Wave või Base kontrolleri
- võrguliides: 10/100 Mbps (RJ45)
- võrgu protokoll: Ethernet II
- kaitseklass: Class II IP20
- värvus: valge

Komplektis:

- Uponor Smatrix Pulse com R-208
- adapter DIN siinile paigaldamiseks
- RJ45 ühenduskaabel (2m)
- esmakäivitusjuhend, ohutusjuhised
- paigaldustarvikud

| Art. nr. | Frequency MHz | l mm | b mm | d mm | uPoints | 2. pak. | pakend | UOM |
|--------------------|------------------|---------|---------|---------|---------|---------|--------|-----|
| NEW 1093030 | 868 | 110 | 21 | 110 | 600 | 16 | 1 | tk |



Uponor Smatrix Wave

Uponor Smatrix Wave kontrolleri Pulse X-265 6X

- kontrolleri koos antenniga juhtmevabadele termostaatidele
- kaitseklass: Class II IP20
- värvus: valge

Komplektis:

- Uponor Smatrix Wave kontrolleri Pulse X-265 6X
- Uponor Smatrix Wave antenn Pulse A-265
- esmakäivitus juhend, ohutusjuhised
- paigaldustarvikud



| Art. nr. | TP V | Frequency MHz | l mm | b mm | d mm | uPoints | 2. pak. | pakend | UOM |
|--------------------|---------|------------------|---------|---------|---------|---------|---------|--------|-----|
| NEW 1093021 | 230 | 868 | 340 | 110 | 55 | 300 | 4 | 1 | tk |

Uponor Smatrix Wave lisamoodul Pulse M-262 6X

- 6 kanaliga lisamoodul kontrolleri Pulse X-265 6X
- võimaldab lisada 6 termostaati ja ajamit
- click-ühendus
- kaitseklass: IP20
- värvus: valge



| Art. nr. | l mm | b mm | d mm | 2. pak. | pakend | UOM |
|--------------------|---------|---------|---------|---------|--------|-----|
| NEW 1093133 | 141 | 110 | 55 | 16 | 1 | tk |

Uponor SPI Smatrix Wave antenn Pulse A-265

- varuantenn kontrolleri Pulse X-265 6X
- kaabli pikkus: 3m
- pistik: RJ45
- värvus: valge

Komplektis:

- Uponor SPI Smatrix Wave antenn Pulse A-265 (koos ühenduskaabliga)
- kinnitustarvikud



| Art. nr. | Frequency MHz | l mm | b mm | d mm | 2. pak. | pakend | UOM |
|--------------------|------------------|---------|---------|---------|---------|--------|-----|
| NEW 1093028 | 868 | 30 | 110 | 9 | 16 | 1 | tk |

Uponor Smatrix Wave

Uponor Smatrix Wave releemoodul M-161

- kahe väljundiga vastuvõtja kontrolleriitele Uponor Smatrix Wave või Uponor Smatrix Wave Pulse
- 2 potentsiaalivaba või 230V 5A väljundit
- pump / kuivati režiim
- pump / K/J lülitusrežiim
- katel / jahuti režiim
- tegevusraadius: max. 30m
- kaitseklass: Class II IP30
- värvus: valge

Komplektis:

- Uponor Smatrix Wave releemoodul M-161 2X
- toide
- paigaldustarvikud



| Art. nr. | Dimension | Frequency MHz | l mm | b mm | d mm | 2. pak. | pakend | UOM |
|----------------|-----------|---------------|------|--------|-------|---------|--------|-----|
| 1071673 | 2X | 868 | 50 | 107,35 | 27,50 | 16 | 1 | tk |

Uponor Smatrix Wave dig. termostaat + RH Style T-169

- juhtmevaba termostaat
- mõõdab ja kuvab tajutavat ruumi temperatuuri ja suhtelist niiskust
- värvus: valge RAL 9016

Funktsioonid:

- kütte või jahutuse vajaduse indikatsioon
- RH mõõtmine ja kuvamine
- comfort / ECO indikatsioon
- ECO seade muutmine
- K/J käsitsi ümberlülitus
- jahutuse võimaldamine (ruumipõhine)
- temperatuuri näit celsius või fahrenheit
- mõõtmisviisid: ruumi temperatuur (RT), ruumi temperatuur koos põranda max/min temperatuur (RFT), kaugandur (RS), välistemperatuuri andur (RO)
- patarei tühjenemise indikaator
- temperatuuri näidu kalibreerimine
- ühildub Smatrix Move kontrolleriiga H/C Radio X-158
- lisa: põranda-, kaug- või välistemperatuuri anduri ühendamise võimalus

Komplektis:

- Uponor Smatrix Wave termostaat D+RH Style T-169
- 1x CR2032 patarei
- paigaldustarvikud



| Art. nr. | Frequency MHz | l mm | b mm | d mm | uPoints | pakend | UOM |
|----------------|---------------|------|------|------|---------|--------|-----|
| 1087816 | 868 | 80 | 80 | 9 | 100 | 1 | tk |

Uponor Smatrix Wave

Uponor Smatrix Wave dig. termostaat + RH Style T-169

- **juhtmevaba termostaat**
- mõõdab ja kuvab tajutavat ruumi temperatuuri ja suhtelist niiskust
- värvus: must

Funktsioonid:

- kütte või jahutuse vajaduse indikatsioon
- RH mõõtmine ja kuvamine
- comfort / ECO indikatsioon
- ECO seade muutmine
- K/J käsitsi ümberlülitus
- jahutuse võimaldamine (ruumipõhine)
- temperatuuri näit celsius või fahrenheit
- mõõtmisviisid: ruumi temperatuur (RT), ruumi temperatuur koos põranda max/min temperatuur (RFT), kaugandur (RS), välistemperatuuri andur (RO)
- patarei tühjenemise indikaator
- temperatuuri näidu kalibreerimine
- ühildub Smatrix Move kontrolloriga H/C Radio X-158
- lisa: põranda-, kaug- või välistemperatuuri anduri ühendamise võimalus

Komplektis:

- Uponor Smatrix Wave termostaat D+RH Style T-169
- 1x CR2032 patarei
- paigaldustarvikud



| Art. nr. | Dimension | Frequency MHz | l mm | b mm | d mm | uPoints | pakend | UOM |
|----------|-----------|---------------|------|------|------|---------|--------|-----|
| 1087817 | BLACK | 868 | 80 | 80 | 9 | 100 | 1 | tk |

Uponor Smatrix Wave temp + RH andur Style T-161

- **juhtmevaba termostaat/andur**
- kasutamiseks avalikes ruumides
- temperatuuri seadistamine ainult koos ühendusmooduli ja äpi-ga
- Vaikimisi seade 21° C
- ruumi temperatuuri ja suhtelise niiskuse andur
- tegevusraadius: max. 30m
- kaitseklass: IP30
- värvus: valge RAL9016

Komplektis:

- Uponor Smatrix Wave ruumi andur+RH Style T-161
- 1x CR2032 patarei
- paigaldustarvikud



| Art. nr. | Frequency MHz | l mm | b mm | d mm | uPoints | pakend | UOM |
|----------|---------------|------|------|------|---------|--------|-----|
| 1087815 | 868 | 55 | 55 | 9 | 100 | 1 | tk |

Uponor Smatrix Wave

Uponor Smatrix Wave T-168

- juhtmevaba (programmeeritav) termostaat
- mõõdab ja kuvab tajutavat ruumi temperatuuri ja suhtelist niiskust
- värvus: läikiv valge

Funktsioonid:

- kütte või jahutuse vajaduse indikatsioon
- RH piiri indikatsioon
- individuaalne öine temperatuurialandus
- rakendusaja kuvamine
- 6 eelprogrammeeritud graafikut
- 1 vabalt programmeeritav graafik
- K/J käsitsi ümberlülitus (ainult koos Uponor Smatrix Move)
- jahutuse lubamine (ruumipõhine)
- temperatuuri näit celsius või fahrenheit
- mõõtmisviisid: ruumi temperatuur (RT), ruumi temperatuur koos põranda max/min temperatuuriga (RFT), kauganduriga (RS), välistemperatuuri anduriga (RO)
- taustavalgus (tumeneb 10 sek. peale viimast nupulevajutust)
- kuvab tarkvara versiooni (siselülitamisel)
- patarei tühjenemise indikaator
- ühildub Smatrix Move kontrolloriga H/C Radio C-157
- lisa: põranda anduri ühendamise võimalus

Komplektis:

- Uponor Smatrix Wave termostaat prog.+RH T-168
- 2x AAA patareid
- paigaldustarvikud



| Art. nr. | Dimension | Frequency MHz | l mm | b mm | d mm | uPoints | pakend | UOM |
|----------|-----------|------------------|---------|---------|---------|---------|--------|-----|
| 1086984 | RAL9016 | 868 | 80 | 80 | 26,5 | 100 | 1 | tk |

Uponor Smatrix Wave

Uponor Smatrix Wave T-166

juhtmevaba termostaat

- mõõdab ja kuvab tajutavat ruumi temperatuuri
- tegevusraadius: max. 30m
- kaitseklass: IP30
- värvus: läikiv valge

Funktsioonid:

- kütte või jahutuse vajaduse indikatsioon
- K/J käsitsi ümberlülitus (ainult koos Uponor Smatrix Move)
- jahutuse lubamine (ruumipõhine)
- temperatuuri näit celsius või fahrenheit
- mõõtmisviisid: ruumi temperatuur (RT), ruumi temperatuur kood pöranda temperatuuriga max/min (RFT), kauganduriga (RS), välistemperatuuri anduriga (RO)
- patarei tühjenemise indikaator
- režiimi muutmine taimeri järgi
- öine temperatuurialandus
- taustavalgus (tumeneb 10 sekundit peale viimast nupulevajutust)
- kuvab tarkvara versiooni (siselülitamisel)
- ühildub Uponor Smatrix Move kontrolleri H/C Radio C-157
- lisa: pöranda anduri ühendamise võimalus

Komplektis:

- Uponor Smatrix Wave termostaat digital T-166
- 2x AAA patareid
- paigaldustarvikud



| Art. nr. | Dimension | Frequency MHz | l mm | b mm | d mm | pakend | UOM |
|----------|-----------|---------------|------|------|------|--------|-----|
| 1086982 | RAL9016 | 868 | 80 | 80 | 26,5 | 1 | tk |

Uponor Smatrix Wave T-165 POD

juhtmevaba termostaat

- mõõdab tajutavat ruumi temperatuuri
- kaitseklass: IP30
- värvus: läikiv valge

Funktsioonid:

- taustavalgus reguleeriketta pöörämisel
- kütte/jahutus-vajaduse indikatsioon
- lüliti taimeri funktsiooni lubamiseks

Komplektis:

- Uponor Smatrix Wave termostaat standard T-165 POD
- 2x AAA patareid
- paigaldustarvikud



| Art. nr. | Dimension | Frequency MHz | l mm | b mm | h mm | pakend | UOM |
|----------|-----------|---------------|------|------|------|--------|-----|
| 1086981 | RAL9016 | 868 | 80 | 80 | 26,5 | 1 | tk |

Uponor Smatrix Wave

Uponor Smatrix Wave T-163

- „Public“ juhtmevaba termostaat ilma näidikuta
- Avalikesse ruumidesse
- tegevusraadius: max. 30m
- värvus: läikiv valge

Funktsioonid:

- potentsiomeeter temperatuuri seadmiseks kaane all
- avamisandur
- releekontakt sisend forsseeritud ECO režiimile läbi BMS
- releekontakt kütte/jahutuse ümberlülituseks
- mikrolülitid režiimide/andurite valikuks
- lisa: põrand-, kaug- või välistemperatuuri anduri ühendamise võimalus

Komplektis:

- Uponor Smatrix Wave termostaat public T-163
- 2x AAA patareid
- paigaldustarvikud



| Art. nr. | Dimension | Frequency MHz | l mm | b mm | d mm | pakend | UOM |
|----------|-----------|---------------|------|------|------|--------|-----|
| 1086979 | RAL9016 | 868 | 80 | 80 | 26,5 | 1 | tk |

Uponor Smatrix Wave termostaatpea T-162

- digitaalne ajamiga radiaatori termostaatpea
- sobivus erinevate radiaatorventiilidega (Danfoss, Heimeier, Honeywell, Siemens, Sauter, jne.)
- värvus: läikiv valge

Funktsioonid:

- comfort/ECO seadistused
- programmeeritav nädalaks
- puhkuse režiim
- külmumiskaitse
- kiirendav funktsioon
- taustavalgus
- lisa: automaatne suve/talveaeg

Komplektis:

- Uponor Smatrix Wave termostaatpea T-162
- 2x AA patareid
- erinevad adapterid
- juhend



NEW

| Art. nr. | Frequency MHz | l mm | b mm | d mm | uPoints | 2. pak. | pakend | UOM |
|----------|---------------|------|------|------|---------|---------|--------|-----|
| 1071660 | 868 | 69 | 51 | 99 | 100 | 24 | 1 | tk |

Uponor Smatrix Wave

Uponor Smatrix alusraam T-X A-1XX

- Smatrix termostaatide alusraam
- Sobib termostaatidele: **T-143; T-145; T-146**
- **T-163; T-165; T-166**
- värvus: läikiv valge (RAL9016)



| Art. nr. | Dimension | l mm | h mm | d mm | pakend | UOM |
|----------------|-----------|---------|---------|---------|--------|-----|
| 1086986 | RAL9016 | 90 | 90 | 2,1 | 1 | tk |

Uponor Smatrix lisaandur S-1XX

- kasutatav koos Uponor Smatrix Wave/Base(Pro) termostaatidega
- kasutatav põranda- või kaugandurina
- pikkus: 3m
- anduri tüüp: NTC 10kOhm, 25°C



| Art. nr. | L m | pakend | UOM |
|----------------|--------|--------|-----|
| 1071684 | 3 | 1 | tk |

Uponor Smatrix rele moodul K/J M-1XX

- **24V releemoodul** kütte-või jahutusseadme lülitamiseks
- K/J ümberlülitamiseks Uponor Smatrix ja K/J allika vahel
- kompl. pesa DIN siinile paigaldamiseks, juhend, paigaldustarvikud
- kontakt: 2 ümberlülituskontakti
- Umähis: 24VDC
- testi ping: 5kV
- kaitseklass: IP40
- lülituspinge: 380VAC, 125VDC
- lülitusvool: 5A@250VAC, 5A@30VDC
- kontakti materjal: Ag+Au kattega
- temperatuuri vahemik: -40°C...+70°C



NEW

| Art. nr. | Dimension | TP V | l mm | b mm | d mm | pakend | UOM |
|----------------|-----------|---------|---------|---------|---------|--------|-----|
| 1083576 | 24V | 24 | 85,5 | 16 | 70,5 | 1 | tk |

Uponor Smatrix Wave

Uponor Smatrix relee moodul K/J M-1XX

- **230 V releemoodul** kütte-või jahutusseadme lülitamiseks
- K/J ümberlülitamiseks Uponor Smatrix ja K/J allika vahel
- kompl. pesa DIN siinile paigaldamiseks, juhend, paigaldustarvikud
- kontakt: 2 ümberlülituskontakti
- Umähis: 230VAC
- testi pinge: 5kV
- kaitseklass: IP40
- lülituspinge: 380VAC, 125VDC
- lülitusvool: 5A@250VAC, 5A@30VDC
- kontakti materjal: Ag+Au kattega
- temperatuuri vahemik: -40°C...+70°C



| Art. nr. | Dimension | TP V | l mm | b mm | d mm | 2. pak. | pakend | UOM |
|----------------|-----------|---------|---------|---------|---------|---------|--------|-----|
| 1083577 | 230V | 230 | 85,5 | 16 | 70,5 | 16 | 1 | tk |

Uponor Smatrix Base

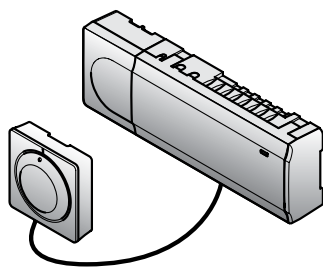

Smatrix Base-juhtmega termostaatidega süsteemile. Automaatne tasakaalustufunktsioon optimeerib energia kasutamist.

Eelised

- Kasutatav nii kiirgusküttes, kui -jahutuses
- Automaatne tasakaalustamine
- Kiire paigaldus
- Lihtne kasutada
- Väike hooldusvajadus



Kirjeldus

■ juhtmega termostaadid

- kuni 4 kontrolleri ühes süsteemis
- toitepinge: 230V
- automaatne tasakaalustus optimeerib energia kasutust ja mugavust
- elektriline juhtimine
- kuni 6 ruumi termostaati ja 8 ajamit (24V) kontrolleri kohta
- pumba ja katla releed
- ajami ja pumba sundkäivitus
- suhtelise niiskuse kontroll
- erinevad kaabeldusvõimalused (pärg-/tähtühendus)
- 4-sooneline Bus kaabeldus
- ühendusprotokoll: RS485 seeria bus
- ajami max. võimsus: 24VAC / 0.2A (0.4A käivitusel)
- lokaalne juurdepääs (Wi-Fi) või kaugjuurdepääs (vajalik interneti ühendus) Uponor Smatrix Pulse rakenduse abil (R-208)
- ajutine wi-fi ühenduspunkt juurdepääsuks (kui kohalik wi-fi ei ole saadaval) (R-208)
- nutikodu ökosüsteemi integratsioon (Amazon Alexa, Google Home) (R-208)
- mitme hoone juhtimine (R-208)
- kolmanda osapoole juurdepääs kaugtoeks (R-208)
- möödunud perioodi trendide analüüs Uponor Smatrix Pulse rakenduse abil (R-208)
- taimeri programmeerimine (R-208)
- mugavusseaded (R-208)
- pealevoolu diagnostika (R-208)
- ECO/comfort seadistused (I-143)

Kasutusala

- juhtmetega ruumi temperatuuri juhtimine, kiirgusküte ja -jahutus
- seadepiirkond: +5°C ... +35°C

Sertifitseerimine

- CE / EAC

Uponor Smatrix Base

Uponor Smatrix Base stardipakett Pulse S

- kasutusvalmis hooldevaba pörandakütteautomaatika stardipakett
- **juhtmega termostaadid**
- laiendatav vastavalt vajadusele
- ühildub Uponor Smatrix Base kontrolleri Pulse X-245 6X
- kaitseklass: II IP20
- värvus: valge

Komplektis:

- 1x Uponor Smatrix Pulse com R-208
- 1x Uponor Smatrix Base kontrolleri Pulse X-245 6X
- 3x Uponor Smatrix Base termostaat D+RH Style T-149
- esmapaigalduse juhend, ohutusjuhendid
- paigaldustarvikud

NEW

Art. nr.

1093280

uPoints



700

2. pak.

3

pakend UOM

1

kompl.



Uponor Smatrix Base stardipakett Pulse L

- kasutusvalmis hooldevaba pörandakütteautomaatika stardipakett
- **juhtmega termostaadid**
- laiendatav vastavalt vajadusele
- ühildub Uponor Smatrix Base kontrolleri Pulse X-245 6X
- kaitseklass: II IP20
- värvus: valge

Komplektis:

- 1x Uponor Smatrix Pulse com R-208
- 2x Uponor Smatrix Base kontrolleri Pulse X-245 6X
- 5x Uponor Smatrix Base termostaat D+RH Style T-149
- esmapaigalduse juhend, ohutusjuhendid
- paigaldustarvikud

NEW

Art. nr.

1093282

uPoints



700

2. pak.

2

pakend UOM

1

kompl.



Uponor Smatrix Base

Uponor Smatrix Base Pulse X-245+R-208 6X

- kasutusvalmis komplekt: kontrolleri ja ühendusmoodul R-208
- juutmega termostaatidele
- laiendatav vastavalt vajadusele
- kaitseklass: II IP20
- Värvus: valge

Komplektis:

- 1x Uponor Smatrix Pulse com R-208
- 1x Uponor Smatrix Base kontrolleri Pulse X-245 Bus 6X
- esmapaigalduse juhend, ohutusjuhendid
- paigaldustarvikud

NEW

| Art. nr. | TP V | uPoints | 2. pak. | pakend | UOM |
|----------|---------|---------|---------|--------|--------|
| 1093019 | 230 | 700 | 3 | 1 | kompl. |



Uponor Smatrix Pulse com Pulse com R-208

- ühendusmoodul
- **sama moodul nii juhtmega kui ka juhtmevabadele kontrolleritele/termostaatidele**
- loob ühenduse Uponor Smatrix Pulse süsteemi, Uponor Smatrix Pulse rakenduse ja Uponor pilve vahel

Ühilduvus:

- Uponor Smatrix Base kontrolleri Pulse X-245 Bus 6X
- Uponor Smatrix Wave kontrolleri Pulse X-265 6X

- toide: RJ45 kaabel Wave või Base kontrolleri
- võrguliides: 10/100 Mbps (RJ45)
- võrgu protokoll: Ethernet II
- kaitseklass: Class II IP20
- värvus: valge

Komplektis:

- Uponor Smatrix Pulse com R-208
- adapter DIN siinile paigaldamiseks
- RJ45 ühenduskaabel (2m)
- esmakäivitusjuhend, ohutusjuhised
- paigaldustarvikud

NEW

| Art. nr. | Frequency MHz | l mm | b mm | d mm | uPoints | 2. pak. | pakend | UOM |
|----------|------------------|---------|---------|---------|---------|---------|--------|-----|
| 1093030 | 868 | 110 | 21 | 110 | 600 | 16 | 1 | tk |



Uponor Smatrix Base

Uponor Smatrix Base kontrolleri Pulse X-245 BUS 6X

- juhtmega termostaatidele
- kaitseklass: Class II IP20
- värvus: valge

Komplektis:

- Uponor Smatrix Base kontrolleri Pulse X-245 Bus 6X
- esmakäivitusjuhend, ohutusjuhised
- paigaldustarvikud



NEW

| Art. nr. | TP | l | b | d | uPoints | 2. pak. | pakend | UOM |
|----------------|----|-----|-----|-----|---------|---------|--------|-----|
| | V | mm | mm | mm | | | | |
| 1093017 | | 230 | 340 | 110 | 300 | 4 | 1 | tk |

Uponor Smatrix Base lisamoodul Pulse M-242 BUS 6X

- 6 kanaliga lisamoodul Uponor Smatrix Base kontrolleri Pulse X-245 Bus 6X
- lisab kuni 6 ruumi termostaati ja 6 ajamit
- click-kinnitus
- kaitseklass: IP20
- värvus: valge



NEW

| Art. nr. | l | b | d | 2. pak. | pakend | UOM |
|----------------|-----|-----|----|---------|--------|-----|
| | mm | mm | mm | | | |
| 1093134 | 141 | 110 | 55 | 16 | 1 | tk |

Uponor Smatrix Base tähtmoodul Pulse M-243 BUS 6X

- 6 kanaliga tähtmoodul Uponor Smatrix Base kontrolleri Pulse X-245 Bus 6X
- täht topoloogia ühendusviis
- toetab kuni 6 termostaati
- kaitseklass: IP20
- värvus: valge



NEW

| Art. nr. | l | b | d | 2. pak. | pakend | UOM |
|----------------|-----|-----|----|---------|--------|-----|
| | mm | mm | mm | | | |
| 1093135 | 141 | 110 | 55 | 16 | 1 | tk |

Uponor Smatrix Base

Uponor Smatrix Base dig. termostaat+RH Style T-149 Bus

- juhtmega termostaat
- mõõdab ja kuvab tajutavat ruumi temperatuuri ja suhtelist niiskust
- värvus: valge RAL9016

Funktsioonid:

- kütte või jahutuse vajaduse indikatsioon
- suhtelise niiskuse mõõtmine ja kuvamine
- comfort / ECO indikatsioon
- ECO seade muutmine
- K/J käsitsi ümberlülitus
- jahutuse võimaldamine (ruumipõhine)
- temperatuuri näit celsius või fahrenheit
- mõõtmisviisid: ruumi temperatuur (RT), ruumi temperatuur koos põranda max/min temperatuur (RFT), kaugandur (RS), välistemperatuuri andur (RO)
- temperatuuri näidu kalibreerimine
- lisa: põranda-, kaug- või välistemperatuuri anduri ühendamise võimalus

Komplektis:

- Uponor Smatrix Base termostaat D+RH Style T-149
- paigaldustarvikud

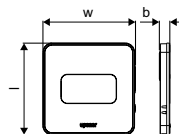

| Art. nr. | l mm | b mm | w mm | uPoints | pakend | UOM |
|----------|---------|---------|---------|---------|--------|-----|
| 1087813 | 80 | 9 | 81 | 100 | 1 | tk |

Uponor Smatrix Base

Uponor Smatrix Base dig. termostaat + RH Style T-149 Bus

- mõõdab ja kuvab tajutavat ruumi temperatuuri ja suhtelist niiskust
- **juhtmega termostaat**
- värvus: must

Funktsioonid:

- kütte või jahutuse vajaduse indikatsioon
- suhtelise õhuniiskuse mõõtmine ja kuvamine
- comfort / ECO indikatsioon
- ECO seade muutmine
- K/J käsitsi ümberlülitus
- jahutuse võimaldamine (ruumipõhine)
- temperatuuri näit celsius või fahrenheit
- mõõtmisviisid: ruumi temperatuur (RT), ruumi temperatuur koos pöranda max/min temperatuur (RFT), kaugandur (RS), välistemperatuuri andur (RO)
- temperatuuri näidu kalibreerimine
- lisa: pöranda-, kaug- või välistemperatuuri anduri ühendamise võimalus

Komplektis:

- Uponor Smatrix Base termostaat D+RH Style T-149
- paigaldustarvikud

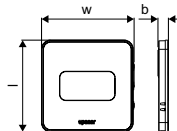

| Art. nr. | Dimension | l mm | w mm | uPoints | pakend | UOM |
|----------|-----------|---------|---------|---------|--------|-----|
| 1087814 | BLACK | 80 | 81 | 100 | 1 | tk |

Uponor Smatrix Base PRO temp ja RH andur Style T-141 Bus

- **juhtmega** ruumi temperatuuri ja suhtelise niiskuse **andur/termostaat**
- avalikesse ruumidesse
- seadistav läbi liidese i-147
- tehaseseadistus 21°C
- kaitseklass: IP30
- värvus: valge RAL9016

Komplektis:

- Uponor Smatrix Base PRO ruumi andur+RH Style T-141 Bus
- paigaldustarvikud



| Art. nr. | Dimension | l mm | b mm | d mm | uPoints | pakend | UOM |
|----------|-----------|---------|---------|---------|---------|--------|-----|
| 1087812 | FLUSH | 55 | 55 | 9 | 100 | 1 | tk |

Uponor Smatrix Base

Uponor Smatrix Base taimer I-143 Bus

- juhtmega taimer (ei ole termostaat)
- esmakäivituse juhised
- puhkuse režiim
- comfort/ECO indikatsioon
- käsitsi K/J ümberlülituse funktsioon
- 6 eelprogrammeeritud graafikut
- 1 vabalt programmeeritav graafik
- ECO väärtuse seadistus
- kella korrigeerimine
- taimerifunktsioonid
- automaatse tasakaalustuse aktiveerimine/deaktiveerimine
- taustavalgus
- esmakäivitusel kuvab tarkvara versiooni
- kaitseklass: IP30
- värvus: läikiv valge

Komplektis:

- Uponor Smatrix Base taimer I-143 Bus
- paigaldustarvikud



| Art. nr. | Dimension | l mm | b mm | d mm | pakend | UOM |
|----------|-----------|---------|---------|---------|--------|-----|
| 1086978 | RAL9016 | 80 | 80 | 26,5 | 1 | tk |

Uponor Smatrix Base progr. termostaat T-148 Bus

- programmeeritav juhtmega termostaat
- mõõdab ja kuvab tajutavat ruumi temperatuuri ja suhtelist niiskust
- kaitseklass: IP30
- värvus: läikiv valge

Funktsioonid:

- kütte või jahutuse vajaduse indikatsioon
- suhtelise niiskuse piirväärtuse indikatsioon
- individuaalne öine temperatuuri alandus
- esmakäivituse juhised
- 6 eelprogrammeeritud graafikut
- 1 vabalt programmeeritav graafik
- jahutus lubatud funktsioon (ruumipõhine)
- temperatuuri näit celsius või fahrenheit
- reguleerimisviisid: ruumi temperatuur (RT), ruumi temperatuur koos pöranda max/min (RFT), kauganduriga (RS), välistemperatuuri anduriga (RO)
- taustavalgus (tumeneb 10 sekundit peale viimast nupuvajutust)
- kuvab tarkvara versiooni (esmakäivitusel)
- lisa: pöranda või välisanduri ühendamise võimalus

Komplektis:

- Uponor Smatrix Base termostaat Prog.+RH T-148 Bus
- paigaldustarvikud



| Art. nr. | Dimension | l mm | b mm | d mm | uPoints | pakend | UOM |
|----------|-----------|---------|---------|---------|---------|--------|-----|
| 1086977 | RAL9016 | 80 | 80 | 26,5 | 100 | 1 | tk |

Uponor Smatrix Base

Uponor Smatrix Base dig. termostaat T-146 Bus

- digitaalse näiduga juhtmega termostaat
- mõõdab ja kuvab tajutavat ruumi temperatuuri
- kaitseklass: IP30
- värvus: läikiv valge

Funktsioonid:

- kütte või jahutuse vajaduse indikatsioon
- individuaalne öine temperatuuri alandus
- esmakäivituse juhised
- jahutus lubatud funktsioon (ruumipõhine)
- temperatuuri näit celsius või fahrenheit
- reguleerimisviisid: ruumi temperatuur (RT), ruumi temperatuur koos pöranda max/min (RFT), kauganduriga (RS), välistemperatuuri anduriga (RO)
- taustavalgus (tumeneb 10 sekundit peale viimast nupuvajutust)
- kuvab tarkvara versiooni (esmakäivitusel)
- lisa: pöranda anduri ühendamise võimalus

Komplektis:

- Uponor Smatrix Base termostaat T-146 Bus
- paigaldustarvikud



| Art. nr. | Dimension | l mm | b mm | d mm | pakend | UOM |
|----------|-----------|---------|---------|---------|--------|-----|
| 1086976 | RAL9016 | 80 | 80 | 26,5 | 1 | tk |

Uponor Smatrix Base standard termostaat T-145 Bus POD

- juhtmega termostaat
- mõõdab tajutavat ruumi temperatuuri
- kaitseklass: IP30
- värvus: läikiv valge

Funktsioonid:

- reguleeritava taustavalguse seadistuse ajal
- kütte/jahutuse vajaduse indikatsioon
- mikrolüliti taimerifunktsiooni sisse/välja lülitamiseks, kui süsteemi on paigaldatud taimer
- lisa: taimerifunktsioon lubatud/ väljas

Komplektis:

- Uponor Smatrix Base termostaat standard T-145 Bus POD
- paigaldustarvikud



| Art. nr. | Dimension | l mm | b mm | d mm | pakend | UOM |
|----------|-----------|---------|---------|---------|--------|-----|
| 1086975 | RAL9016 | 80 | 80 | 26,5 | 1 | tk |

Uponor Smatrix Base

Uponor Smatrix Base süvist. termostaat T-144 Bus

■ juhtmega termostaat

- mõõdab ja kuvab tajutavat ruumi temperatuuri
- süvistatud paigalduseks, komplektis raam
- erinevate paigaldusraamide kasutamise võimalus
- kaitseklass: IP30
- värvus: läikiv valge

Funktsioonid:

- kütte/jahutuse vajaduse indikatsioon
- mikrolüliti taimer funktsiooni lubamiseks, kui süteemi on paigaldatud taimer

Komplektis:

- Uponor Smatrix Base süvistatud termostaat T-144 Bus
- paigaldustarvikud
- välisraam



| Art. nr. | Dimension | l mm | b mm | d mm | pakend | UOM |
|----------|-----------|---------|---------|---------|--------|-----|
| 1086973 | RAL9016 | 81,5 | 81,5 | 41,7 | 1 | tk |

Uponor Smatrix Base termostaat public T-143 Bus

■ juhtmega termostaat avalikesse ruumidesse

- mõõdab tajutavat ruumi temperatuuri
- kaitseklass: IP30
- värvus: läikiv valge

Funktsioonid:

- potentsiomeeter temperatuuri seadmiseks kaane all
- avamisandur
- releekontakt forsseeritud ECO läbi BMS
- releekontakt kütte/jahutuse ümberlülituseks
- mikrolülitiid funktsioonide või anduri valikuks
- lisa: pöranda-, välis- või kauganduri ühendamise võimalus

Komplektis:

- Uponor Smatrix Base termostaat public T-143 Bus
- paigaldustarvikud



| Art. nr. | Dimension | l mm | b mm | d mm | pakend | UOM |
|----------|-----------|---------|---------|---------|--------|-----|
| 1086972 | RAL9016 | 80 | 80 | 26,5 | 1 | tk |

Uponor Smatrix Base

Uponor Smatrix Base termostaadi alus Style T-149 A-14X

- Termostaadi T-149 paigaldusalus seinapealsel paigaldusel
- paigaldustarvikud
- värvus: valge RAL9016

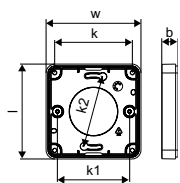

| Art. nr. | l | b | k | k1 | k2 | w | | pakend | UOM |
|----------------|----|----|----|----|----|----|--|--------|-----|
| | mm | mm | mm | mm | mm | mm | | | |
| 1087821 | 79 | 14 | 65 | 60 | 60 | 79 | | 1 | tk |

Uponor Smatrix Base termostaadi alus Style T-149 A-14X

- Termostaadi T-149 paigaldusalus seinapealsel paigaldusel
- paigaldustarvikud
- värvus: must

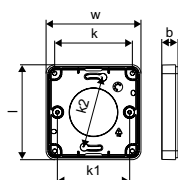

| Art. nr. | Dimension | l | b | k | k1 | k2 | w | | pakend | UOM |
|----------------|-----------|----|----|----|----|----|----|--|--------|-----|
| | | mm | mm | mm | mm | mm | mm | | | |
| 1087822 | BLACK | 79 | 14 | 65 | 60 | 60 | 79 | | 1 | tk |

Uponor Smatrix alusraam T-X A-1XX

- Smatrix termostaatide alusraam
- Sobib termostaatidele: T-143; T-145; T-146
- T-163; T-165; T-166
- värvus: läikiv valge (RAL9016)



| Art. nr. | Dimension | l | h | d | | pakend | UOM |
|----------------|-----------|----|----|-----|--|--------|-----|
| | | mm | mm | mm | | | |
| 1086986 | RAL9016 | 90 | 90 | 2,1 | | 1 | tk |

Uponor Smatrix Base

Uponor Smatrix Base kaabel Bus A-145

- 4-sooneline BUS kaabel Uponor Smatrix Base / Base PRO seadmete ühendamiseks
- 2xtoide / 2x andmeside
- varjestus: alumiinium/polüester kile, sidekiuga
- temperatuurivahemik: -20°C ... +80°C
- ristlõige: AWG22
- kest: PVC
- nimipinge: 400VAC/DC



| Art. nr. | Dimension | L m | 2. pak. | pakend | UOM |
|----------|-----------|--------|---------|--------|-----|
| 1071670 | 50m | 50 | 2 | 1 | tk |

Uponor Smatrix lisaandur S-1XX

- kasutatav koos Uponor Smatrix Wave/Base(Pro) termostaatidega
- kasutatav põranda- või kaugandurina
- pikkus: 3m
- anduri tüüp: NTC 10kOhm, 25°C



| Art. nr. | L m | pakend | UOM |
|----------|--------|--------|-----|
| 1071684 | 3 | 1 | tk |

Uponor Smatrix rele moodul K/J M-1XX

- **24V releemoodul** kütte- või jahutusseadme lülitamiseks
- K/J ümberlülitamiseks Uponor Smatrix ja K/J allika vahel
- kompl. pesa DIN siinile paigaldamiseks, juhend, paigaldustarvikud
- kontakt: 2 ümberlülituskontakti
- Umähis: 24VDC
- testi pinge: 5kV
- kaitseklass: IP40
- lülituspinge: 380VAC, 125VDC
- lülitusvool: 5A@250VAC, 5A@30VDC
- kontakti materjal: Ag+Au kattega
- temperatuuri vahemik: -40°C...+70°C



| Art. nr. | Dimension | TP V | l mm | b mm | d mm | pakend | UOM |
|----------|-----------|---------|---------|---------|---------|--------|-----|
| 1083576 | 24V | 24 | 85,5 | 16 | 70,5 | 1 | tk |

Uponor Smatrix Base

Uponor Smatrix relee moodul K/J M-1XX

- **230 V releemoodul** kütte-või jahutusseadme lülitamiseks
- K/J ümberlülitamiseks Uponor Smatrix ja K/J allika vahel
- kompl. pesa DIN siinile paigaldamiseks, juhend, paigaldustarvikud
- kontakt: 2 ümberlülituskontakti
- Umähis: 230VAC
- testi pinge: 5kV
- kaitseklass: IP40
- lülituspinge: 380VAC, 125VDC
- lülitusvool: 5A@250VAC, 5A@30VDC
- kontakti materjal: Ag+Au kattega
- temperatuuri vahemik: -40°C...+70°C



| Art. nr. | Dimension | TP V | l mm | b mm | d mm | 2. pak. | pakend | UOM |
|----------------|-----------|---------|---------|---------|---------|---------|--------|-----|
| 1083577 | 230V | 230 | 85,5 | 16 | 70,5 | 16 | 1 | tk |

Uponor Smatrix Base PRO

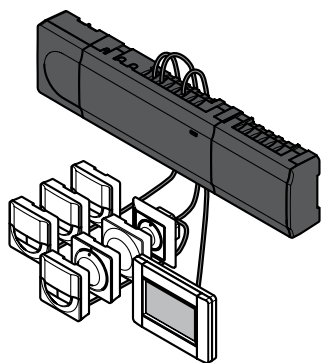

Korterelamute pörandaküt-teautomaatika.

Juhtmega termostaadid.

Kuni 16 kontrolleriit ühes süsteemis.

Kuni 192 ruumi temperatuuri juhtimine puuetundliku liidesega

Eelised

- Kasutatakse kiirguskütte ja -jahutussüsteemides
- Automaatne tasakaalustamine
- Kiire paigaldus
- Lihtne kasutus
- KNX ühilduvus

Automaatne tasakaalustus.

Ühendus Targa kodu lahendustega KNX mooduli abil



Kirjeldus

- juhtmega termostaatidele
- kuni 16 kontrolleriit ühes süsteemis
- toitepinge: 230V
- automaatne tasakaalustus optimeerib energia kasutust ja mugavust
- kuni 6 ruumi termostaati ja 8 ajamit (24V) ühe kontrolleri kohta
- pumba ja katla releed
- ajami ja pumba sundkäivitus
- suhtelise niiskuse kontroll
- erinevad kaabelduse võimalused (pärg- või tähtühendus)
- 4-sooneline BUS kaabeldus
- ühendusprotokoll: RS485
- ajami pinge ja voolutugevus: 24VAC / 0.2A (0.4A käivitusel)
- puute-ekraan kuvab kontrolleri infot ja seadeid
- alandatud temperatuuride programmid igale kanalile
- max/min temperatuuride piirangud
- puhkuse seaded
- automaatne suve/-talveaja vahetus
- möödaviikruumi „by pass“ funktsioon
- süsteemi diagnostika
- trendide kuvamine (seadearvud vs. ruumi temperatuurid, jne)
- tarvikute konfigureerimine
- lisavõimalus: BMS tugi KNX ühendusmooduliga (R-147)

Kasutusala

- kiirguskütte ja -jahutuse ruumi temperatuuride juhtimine suurets süsteemides
- termostaatide seadepiirkond: +5°C ... +35°C

Sertifitseerimine

- CE / EAC

Uponor Smatrix Base PRO

Uponor Smatrix Base PRO juhtimiskomplekt X-147 + I-147 Bus

- Kontrolleri ja puute-ekraani komplekt
- **Juhtmega termostaadid**
- Kaitseklass II IP20
- Värvus: hall RAL7015

Komplektis::

- Uponor Smatrix Base PRO puuteekraan I-147 Bus
- Uponor Smatrix Base PRO kontrolleri X-147 Bus
- paigaldustarvikud
- kirj juhend
- 2x micro SD kaart puute-ekraanile ja kontrolleri
- DIN siin
- toiteplokk ekraanile



| Art. nr. | Dimension | TP V | Frequency MHz | uPoints | 2. pak. | pakend | UOM |
|----------------|-----------|---------|------------------|---------|---------|--------|--------|
| 1087163 | 6X | 230 | 868 | 700 | 3 | 1 | kompl. |

Uponor Smatrix Base PRO kontrolleri X-147 Bus

- ühildub Uponor Smatrix Base PRO liidesega (puute-ekraaniga) I-147 BUS
- **juhtmega termostaatidele**
- kaitseklass: Class II IP20
- värvus: hall RAL7015

Komplektis:

- Uponor Smatrix Base PRO kontrolleri X-147 Bus 6X
- kirj juhend, ohutusjuhised
- mikro SD kaart (paigaldatud)
- DIN siin (pikkus: 37cm)
- paigaldustarvikud



| Art. nr. | Dimension | TP V | l mm | b mm | d mm | uPoints | 2. pak. | pakend | UOM |
|----------------|-----------|---------|---------|---------|---------|---------|---------|--------|-----|
| 1087162 | 6X | 230 | 336 | 110 | 55 | 300 | 4 | 1 | tk |

Uponor SPI Smatrix Base PRO liides I-147 Bus

- puutetundliku ekraaniga liides kontrolleri X-147 Bus 6X
- **juhtmega ühendus kontrolleri**
- kaitseklass: Class II IP20
- värvus: valge RAL9016

Komplektis:

- Uponor Smatrix Base PRO liides I-147
- toiteühendus
- paigaldustarvikud
- seinakinnitus
- juhend



| Art. nr. | l mm | b mm | d mm | uPoints | 2. pak. | pakend | UOM |
|----------------|---------|---------|---------|---------|---------|--------|-----|
| 1087161 | 150 | 108,5 | 43 | 400 | 7 | 1 | tk |

Uponor Smatrix Base PRO

Uponor Smatrix Base PRO ühendusmoodul R-147 KNX

- ühendab Uponor Smatrix Base PRO süsteemi BMS süsteemiga või kolmandate osapoolte KNX seadmetega
- toitepinge: 230VAC (+10%/-15%) / 50/60Hz
- sisemine kaitse: T5 F3.15AL 250V, 5x20 3.15A kiiretoimeline
- töötemperatuur: 0°C ... +45°C
- ladustamistemperatuur: -20°C ... +70°C
- max. tarbitav võimsus: 45W
- toide: 1m kaabel europistikuga
- süsteemi ühendused: 0.2mm² ... 1.5mm²
- kaitseklass: IP20 II

Funktsioonid:

- ruumi temperatuur Uponor Base või kolmanda osapoole KNX termostaatidelt
- ruumi seadearvud Uponor Base või kolmanda osapoole KNX termostaatidelt
- ruumi suhteline niiskus Uponor Base või kolmanda osapoole KNX termostaatidelt
- ruumi pöranda temperatuur Uponor Base või kolmanda osapoole KNX termostaatidelt
- ajamite olek Uponor Base või kolmanda osapoole KNX süsteemist
- forsseeritud ECO režiim Uponor Base PRO või kolmanda osapoole KNX süsteemist
- pumba väljund Uponor Base või kolmanda osapoole KNX süsteemist
- katla väljund Uponor Base või kolmanda osapoole KNX süsteemist
- kütte/jahutuse seadekõverad Uponor Move PRO süsteemist BMS süsteemi või vastupidi
- kütte/ jahutuse režiimid Uponor Base PRO süsteemist BMS süsteemi või vastupidi

Komplektis:

- ühendusmoodul R-147 KNX
- toiteühendus
- paigaldustarvikud
- kiirjuhend



| Art. nr. | TP V | l mm | b mm | d mm | uPoints | pakend | UOM |
|----------------|---------|---------|---------|---------|---------|--------|-----|
| 1087164 | 230 | 90 | 17,5 | 60 | 600 | 1 | tk |

Uponor Smatrix Base lisamoodul M-140 Bus

- 6 kanaliline lisamoodul Uponor Smatrix Base Pro kontrolleri X-147 Bus 6X
- toetab kuni 6 termostaati ja kuni 6 ajamit
- click-kinnitus
- kaitseklass: IP20
- värvus: hall



| Art. nr. | l mm | b mm | d mm | 2. pak. | pakend | UOM |
|----------------|---------|---------|---------|---------|--------|-----|
| 1071690 | 141 | 110 | 55 | 16 | 1 | tk |

Uponor Smatrix Base tähtmoodul M-141 Bus

- 6 kanaliline tähtmoodul Uponor Smatrix Base Pro kontrolleri X-147 Bus 6X
- paindlik võimalik juhtmete ühendusvõimalus (tähttopoloogia)
- toetab kuni 6 termostaati
- kaitseklass: IP20
- värvus: hall



| Art. nr. | l mm | b mm | d mm | 2. pak. | pakend | UOM |
|----------------|---------|---------|---------|---------|--------|-----|
| 1071651 | 141 | 110 | 55 | 16 | 1 | tk |

Uponor Base

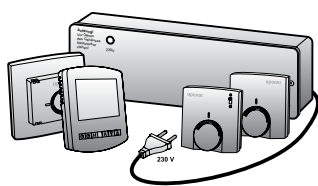

Ökonoomne 230 V pörandakütte süsteemide juhtimis-süsteem.

kahesoonelise kaabliga termostaatide ühendus.

Eelised

- Standardne 230V 2 sooneline kaabeldus
- Lihtsad termostaadid
- Lihtne paigaldada ja kasutada
- Üldlevinud kaabeldus ja juhtimine



Kirjeldus

■ 230V tööpinge

- lihtne kaabeldusviis ja regulaatorid
- lihtne siduda standardse on/off ja aja järgi juhtimisega
- lisa: pumba relee

Kasutusala

- juhtmetega ruumi temperatuuri juhtimine, pörandaküte ja -jahutus

Sertifitseerimine

- CE

Uponor Base kontrolleri X-23

- toetab kuni 6 termostaati (230V)
- toetab kuni 14 ajamit (230V)
- ülekoormuse kaitse
- võimsus: 10VA
- kaitseklass: IP40

Lisad:

- Uponor Base pumba relee X-23 (art. nr. 1058427)

Komplektis:

- Uponor Base kontrolleri X-23
- paigaldustarvikud



| Art. nr. | Dimension | TP V | l mm | b mm | d mm | pakend | UOM |
|----------------|-----------|---------|---------|---------|---------|--------|-----|
| 1058426 | 6X 230V | 230 | 310 | 90 | 65 | 1 | tk |

Uponor Base

Uponor Base pumbarelee X-23

- pumba juhtimiseks
- pumba sundkäivitus (iga päev 5 minutit) paakumise vältimiseks
- ülekoormuse kaitse
- võimsus: 3VA
- kaitseklass: IP40

Komplektis:

- Uponor Base pumba relee X-23
- paigaldustarvikud



| Art. nr. | Dimension | TP V | l mm | b mm | pakend | UOM |
|----------------|-----------|---------|---------|---------|--------|-----|
| 1058427 | 230V | 230 | 310 | 90 | 1 | tk |

Uponor Base kontrolleri X-24

- toetab kuni 6 termostaati (230V)
- toetab kuni 12 ajamit (230V)
- kanali pöördvalija ajamite kiireks rakendamiseks
- ülekoormuse kaitse
- võimsus: 10VA
- kaitseklass: IP40

Komplektis:

- Uponor Base flexiboard X-24
- paigaldustarvikud



| Art. nr. | Dimension | TP V | l mm | b mm | d mm | pakend | UOM |
|----------------|-----------|---------|---------|---------|---------|--------|-----|
| 1088331 | 6X 230V | 230 | 368 | 90 | 65 | 1 | tk |

Uponor Base kontrolleri pumba juhtimisega X-25

- toetab kuni 6 termostaati (230V)
- toetab kuni 12 ajamit (230V)
- kanalite pöördvalija ajamite kiireks rakendamiseks
- pumba relee 2A (230V)
- ülekoormuse kaitse
- võimsus: 10VA
- kaitseklass: IP40

Komplektis:

- Uponor Base flexiboard pumba releega X-25 6X
- paigaldustarvikud



| Art. nr. | Dimension | TP V | l mm | b mm | d mm | pakend | UOM |
|----------------|-----------|---------|---------|---------|---------|--------|-----|
| 1089086 | 6X 230V | 230 | 368 | 90 | 65 | 1 | tk |

Uponor Base

Uponor Base kontrolleri X-26

- toetab kuni 8 termostaati (230V)
- toetab kuni 12 ajamit (230V)
- kanalite pöördvalija ajamite kiireks rakendamiseks
- ülekoormuse kaitse
- võimsus: 10VA
- kaitseklass: IP40

Komplektis:

- Uponor Base flexiboard pumba releega X-26 8X
- paigaldustarvikud



| Art. nr. | Dimension | TP V | l mm | b mm | d mm | pakend | UOM |
|----------------|-----------|---------|---------|---------|---------|--------|-----|
| 1089087 | 8X 230V | 230 | 368 | 90 | 65 | 1 | tk |

Uponor Base kontrolleri pumba juhtimisega X-27

- toetab kuni 8 termostaati (230V)
- toetab kuni 12 ajamit (230V)
- kanalite pöördvalija ajamite kiireks rakendamiseks
- pumba rele 2A (230V)
- ülekoormuse kaitse
- võimsus: 10VA
- kaitseklass: IP40

Komplektis:

- Uponor Base flexiboard pumba releega X-27 8X
- paigaldustarvikud



| Art. nr. | Dimension | TP V | l mm | b mm | d mm | pakend | UOM |
|----------------|-----------|---------|---------|---------|---------|--------|-----|
| 1089088 | 8X 230V | 230 | 368 | 90 | 65 | 1 | tk |

Uponor Base standard termostaat T-23

- Termostaadi reguleerikettale prinditud skaala
- lihtne on/off juhtimine (bimetall)
- seadepiirkond reguleeriketta alt mehaaniliselt piiratud
- toide kontrolleri (Uponor Base kontrolleri X-23)
- seadepiirkond: +5°C ... +30°C
- ühendusjuhe: 4x 1.5mm²
- maks.juhtme pikkus: 100m
- kaitseklass: IP30
- värvus: RAL 9010



| Art. nr. | Dimension | TP V | l mm | b mm | d mm | värvus | pakend | UOM |
|----------------|--------------|---------|---------|---------|---------|----------|--------|-----|
| 1058422 | 230V RAL9010 | 230 | 78 | 78,5 | 13,9 | RAL 9010 | 1 | tk |

Uponor Base

Uponor Base süvistatav termostaat T-24

- reguleerettale prinditud skaalaga termostaat süvistatud paigalduseks
- lihtne on/off juhtimine (bimetall)
- seadepiirkonna mehaanilised piirajad asuvad reguleeretta all
- toide kontrolleriilt (Uponor Base kontrolleri X-23)
- seadepiirkond: +5°C ... +30°C
- kaabel: 4x 1.5mm²
- max. kaabli pikkus: 100m
- kaitseklass: IP30
- värvus: läikiv valge

Komplektis:

- Uponor Base termostaat süvist. T-24 230V
- välisraam 81x85x44.5mm
- kate 50x50mm



| Art. nr. | Dimension | TP V | l mm | b mm | d mm | | pakend | UOM |
|-----------------|-----------|---------|---------|---------|---------|--|--------|-----|
| 1058423* | 230V | 230 | 81 | 85 | 44,5 | | 1 | tk |

Uponor Base dig. progr. termostaat T-26

- kontaktid pörand- või kauganduri ühendamiseks
- programmeeritav - 5/2 või 7 päevale, nelja temperatuuri tasemega igale päevale
- erinevad reguleerimise võimalused - ainult õhk, ainult pörand, õhk ja pörand
- puhkuse režiim
- optimaalne käivitus
- lukustatav
- jooksva režiimi oleku kuva
- toide (Uponor Base kontrolleri X-23)
- lisa: kaugandur (eraldi toode 1047459)
- seadepiirkond: +5°C ... +35°C
- kaitseklass: IP20
- värvus: valge RAL9010



| Art. nr. | Dimension | TP V | l mm | b mm | d mm | värvus | pakend | UOM |
|----------------|--------------|---------|---------|---------|---------|----------|--------|-----|
| 1058425 | 230V RAL9010 | 230 | 85 | 98 | 13 | RAL 9010 | 1 | tk |

Uponor Base lisaandur

- lisaandur termostaadile T-26
- pörand min/max temperatuur
- pikkus: 3m



| Art. nr. | Dimension | L m | pakend | UOM |
|----------------|-----------|--------|--------|-----|
| 1047459 | 230V | 3 | 1 | tk |

Uponor kollektori ajamid

Kontrolli ajami sobivust kollektoriga ajami kirjeldusest

Uponor Vario ajam S

- 24V
- sobib kasutamiseks Uponor plastkollektoriga **Vario M** ja teraskollektoriga **Vario S**
- ainult 24V kontrollritega **Smatrix Wave** ja **Base (24V)**
- Umähis: 24V/50Hz



| Art. nr. | Dimension | d mm | IG mm | TP V | P W | h mm | pakend | UOM |
|----------|-----------|---------|----------|---------|--------|---------|--------|--------|
| 1087778 | 24V | 44 | 30x1,5 | 24 | ~ 1 | 58 | 1 | kompl. |

Uponor Vario ajam S

- 230V
- sobib nii Uponori plast (Vario M) kui roostevabale (Vario S) kollektorile
- ei sobi **Smatrix Wave** ega **Smatrix Base** kontrollritega
- Umähis: 230V/50Hz



| Art. nr. | Dimension | d mm | IG mm | TP V | P W | h mm | pakend | UOM |
|----------|-----------|---------|----------|---------|--------|---------|--------|--------|
| 1087763 | 230V | 44 | 30x1,5 | 230 | ~ 1 | 58 | 1 | kompl. |

Uponor Vario PLUS ajam PRO 24V 1W NC

- 24V
- Sobib kasutamiseks Vario Plus vanat tüüpi Uponor moodul plastkollektoriga
- Komplektis 1 bajonetiga kollektori adaptervõru M30x1.5mm ja paigaldusjuhise
- esmase avanemise funktsioon
- Automaatse tasakaalustuse funktsionaalsus nii uutes paigaldistes kui renoveerimisel
- kõrgus: 58 mm + adaptervõru
- käigu pikkus: 5 mm
- ühenduskaabel: 2x0,75 mm²x1m
- läbimõõt: 44,3 mm
- vastavus: EAC
- värvus: sinine



| Art. nr. | Dimension | d mm | AG mm | TP V | P W | h mm | pakend | UOM |
|----------|----------------|---------|----------|---------|--------|---------|--------|-----|
| 1090262 | VA02 MT 30X1,5 | 44 | 30x1,5 | 24 | ~ 1 | 58 | 1 | tk |

Uponor kollektori ajamid

Uponor Vario PLUS ajam PRO 230V 1W NC

- **230V**
- Sobib kasutamiseks Vario Plus vanat tüüpi **Uponor moodul plastkollektoriga**
- Komplektis 1 bajonetiga kollektori adaptervõru M30x1.5mm ja paigaldusjuhised
- Esmase avanemise funktsioon
- Automaatse tasakaalustuse funktsionaalsus nii uutes paigaldistes kui renoveerimisel
- Kõrgus: 58 mm + adaptervõru
- Käigu pikkus: 5 mm
- Ühenduskaabel: 2x0,75 mm²x1m
- Läbimõõt: 44,3 mm
- Vastavus: EAC
- Värvus: sinine



| Art. nr. | Dimension | d mm | AG mm | TP V | P W | h mm | pakend | UOM |
|----------|----------------|---------|----------|---------|--------|---------|--------|-----|
| 1090263 | VA02 MT 30X1,5 | 44 | 30x1,5 | 230 | ~ 1 | 58 | 1 | tk |

Uponor Vario B ajam PRO 24V 1W NC

- **24V**
- Sobib kasutamiseks vanat tüüpi **messingkollektoriga WGF**
- Komplektis bajonetiga kollektori adaptervõru M28x1.5mm ja paigaldusjuhised
- Esmase avanemise funktsioon
- Automaatse tasakaalustuse funktsionaalsus nii uutes paigaldistes kui renoveerimisel
- Kõrgus: 58 mm + adaptervõru
- Käigupikkus: 5 mm
- Ühenduskaabel: 2x0,75 mm²x1m
- Läbimõõt: 44,3 mm
- Vastavus: EAC
- Värvus: sinine



| Art. nr. | Dimension | d mm | IG mm | TP V | P W | h mm | pakend | UOM |
|----------|----------------|---------|----------|---------|--------|---------|--------|-----|
| 1090264 | VA32 FT 28X1,5 | 44 | 28x1,5 | 24 | ~ 1 | 58 | 1 | tk |

Uponor Vario B ajam PRO 230V 1W NC

- **230V**
- Sobib kasutamiseks vanat tüüpi **messingkollektoriga WGF**
- Komplektis bajonetiga kollektori adaptervõru M28x1.5mm ja paigaldusjuhised
- Esmase avanemise funktsioon
- Automaatse tasakaalustuse funktsionaalsus nii uutes paigaldistes kui renoveerimisel
- Kõrgus: 58 mm + adaptervõru
- Käigupikkus: 5 mm
- Ühenduskaabel: 2x0,75 mm²x1m
- Läbimõõt: 44,3 mm
- Vastavus: EAC
- Värvus: sinine



| Art. nr. | Dimension | d mm | IG mm | TP V | P W | h mm | pakend | UOM |
|----------|----------------|---------|----------|---------|--------|---------|--------|-----|
| 1090265 | VA32 FT 28X1,5 | 44 | 28x1,5 | 230 | ~ 1 | 58 | 1 | tk |

Uponor kollektori ajamid

Uponor Smatrix ajam Retrofit A-XXX

- 24V ajami ja adapterite komplekt
- komplektis kolm adapterit kollektoritega ühendamiseks, kasutusjuhend
- vahelüli kolmandate osapoolte kollektorite ja Uponor Smatrix kontrolleri vahel
- ühildub 80% turul olevate kollektoritega
- avatud/suletud indikaator
- NC (normaalselt suletud) = sulgub pingevabas olekus
- esmaavanemise funktsioon
- toetab automaatse tasakaalustuse funktsiooni
- temperatuuri vahemik: 0°C...60°C
- kõrgus: 58mm + adapterivõru
- värvus: sinine

■ info sobivuse kohta: www.uponor.com/download-centre

- käigu pikkus: 5mm
- ühenduskaabel: 2x 0.75mm² x 1m
- Umähis: 24V/50Hz
- Pmähis: 1W
- läbimõõt: 44.3mm



| Art. nr. | Dimension | d mm | TP V | P W | h mm | pakend | UOM |
|----------------|-------------|---------|---------|--------|---------|--------|--------|
| 1083575 | 24V, NC, 1W | 44 | 24 | ~ 1 | 58 | 1 | kompl. |

Uponor Comfort E



Lihtsalt paigaldatavad Uponor Comfort E elektrilised küttematid ja kaablid. Paigaldage elektriline põrandaküte õhukese 3 mm küttematiga keraamilise põrandakatte või Comfort E Al-kilega küttematiga

laminaat või parkettpõrandate alla. Uponor Comfort E termostaadid aitavad optimeerida küttekulusid.

Eelised

- Ideaalne nii renoveerimisel kui ka uusehitusel
- Sobib keraamilise plaadi, laminaatparketi, puitparketi või vinüülkatetega nii märg- kui kuivpaigaldusel
- Lihtne kasutada vähese kõrguse tõttu
- Lühike reageerimisaeg



Kirjeldus

- põrandaküttematid, kaablid ja termostaadid.

Kasutusala

- elektriline põrandaküte
- paigaldatakse tasanduskihti või plaatimissegusse või vahetult soojustuskihile parketi või laminaadi alla

Termostaadid:

- temperatuuri vahemik: +5°C ... +30°C
- 230V

Sertifitseerimine

- CE; EAC;
- VDE 40046886 Cable Mat

Uponor Comfort E WET-põrandakütte matt

Kirjeldus

- Elektriline lahtirullitav põrandakütte matt märgpaigalduseks
- paigaldatakse tasanduskihti või plaatimissegusse
- iseliimuv matt
- laius 0,5m
- alusele õmmeldud 3 mm kaabel
- varjestatud kahesoonele küttekaabel
- 4m ühenduskaabel
- FEP elektrilise isolatsiooniga küttekaabel
- komplektis kaitsehülss põranda andurile

Kasutusala

- Elektriline põrandaküte
- paigaldatakse tasandus - või plaatimissegusse

Sertifitseerimine

- CE; EAC;
- VDE 40046886
- IPX7

Uponor Comfort E

Uponor Comfort E küttematt

- küttevõimsus 160 W/m²



| Art. nr. | Dimension | Resistance Q Ohm | W | L m | B m | A m ² | uPoints | 2. pak. | pakend | UOM |
|----------|-----------|---------------------|------|--------|--------|---------------------|---------|---------|--------|--------|
| 1088656 | 160-1 | 326 | 160 | 2 | 0,5 | 1 | 140 | 50 | 1 | kompl. |
| 1088657 | 160-1,5 | 224 | 240 | 3 | 0,5 | 1,5 | 170 | 50 | 1 | kompl. |
| 1088658 | 160-2 | 163 | 320 | 4 | 0,5 | 2 | 200 | 50 | 1 | kompl. |
| 1088659 | 160-2,5 | 133 | 400 | 5 | 0,5 | 2,5 | 230 | 50 | 1 | kompl. |
| 1088660 | 160-3 | 110 | 480 | 6 | 0,5 | 3 | 260 | 50 | 1 | kompl. |
| 1088661 | 160-4 | 78 | 640 | 8 | 0,5 | 4 | 310 | 35 | 1 | kompl. |
| 1088662 | 160-5 | 67 | 800 | 10 | 0,5 | 5 | 370 | 35 | 1 | kompl. |
| 1088663 | 160-6 | 53 | 960 | 12 | 0,5 | 6 | 440 | 35 | 1 | kompl. |
| 1088664 | 160-7 | 45 | 1120 | 14 | 0,5 | 7 | 500 | 20 | 1 | kompl. |
| 1088665 | 160-8 | 41 | 1280 | 16 | 0,5 | 8 | 540 | 20 | 1 | kompl. |
| 1088666 | 160-10 | 32 | 1600 | 20 | 0,5 | 10 | 600 | 20 | 1 | kompl. |
| 1088667 | 160-12 | 28 | 1920 | 24 | 0,5 | 12 | 650 | 20 | 1 | kompl. |

Uponor Comfort E küttematt

- küttevõimsus 100 W/m²



| Art. nr. | Dimension | Resistance Q Ohm | kW | L m | B m | A m ² | uPoints | 2. pak. | pakend | UOM |
|-------------|-----------|---------------------|------|--------|--------|---------------------|---------|---------|--------|--------|
| NEW 1093461 | 100-1 | 498 | 100 | 2 | 0,5 | 1 | 140 | 50 | 1 | kompl. |
| NEW 1093462 | 100-1,5 | 328 | 150 | 3 | 0,5 | 1,5 | 170 | 50 | 1 | kompl. |
| NEW 1093463 | 100-2 | 259 | 200 | 4 | 0,5 | 2 | 200 | 50 | 1 | kompl. |
| NEW 1093464 | 100-2,5 | 202 | 250 | 5 | 0,5 | 2,5 | 230 | 50 | 1 | kompl. |
| NEW 1093465 | 100-3 | 161 | 300 | 6 | 0,5 | 3 | 260 | 50 | 1 | kompl. |
| NEW 1093466 | 100-4 | 125 | 400 | 8 | 0,5 | 4 | 310 | 35 | 1 | kompl. |
| NEW 1093467 | 100-5 | 98 | 500 | 10 | 0,5 | 5 | 370 | 35 | 1 | kompl. |
| NEW 1093468 | 100-6 | 84 | 600 | 12 | 0,5 | 6 | 440 | 35 | 1 | kompl. |
| NEW 1093469 | 100-7 | 77 | 700 | 14 | 0,5 | 7 | 500 | 20 | 1 | kompl. |
| NEW 1093470 | 100-8 | 61 | 800 | 16 | 0,5 | 8 | 540 | 20 | 1 | kompl. |
| NEW 1093471 | 100-10 | 53 | 1000 | 20 | 0,5 | 10 | 600 | 20 | 1 | kompl. |
| NEW 1093472 | 100-12 | 42 | 1200 | 24 | 0,5 | 12 | 650 | 20 | 1 | kompl. |

Uponor Comfort E WET-küttekabel

Kirjeldus

- Elektriline küttekabel
- paigaldatakse tasanduskihti või plaatimissegusse
- kaabli läbimõõt 3mm
- varjestatud kahesooneeline küttekabel
- 4m ühenduskabel
- FEP elektrilise isolatsiooniga küttekabel
- komplektis kaitsehülss põranda andurile
- komplektis kaabli kinnitusteip

Kasutusala

- Elektriline põrandaküte
- paigaldatakse tasandus - või plaatimissegusse

Sertifitseerimine

- CE; EAC
- IPX7

Uponor Comfort E

Uponor Comfort E kaabel



| Art. nr. | Dimension | Resistance Ohm | uPoints | pakend | UOM |
|----------------|------------|----------------|---------|--------|--------|
| 1093451 | 150W 13M | 353 | 140 | 1 | kompl. |
| 1093452 | 300W 25M | 176 | 200 | 1 | kompl. |
| 1093453 | 460W 37M | 115 | 230 | 1 | kompl. |
| 1093454 | 700W 54M | 76 | 310 | 1 | kompl. |
| 1093455 | 930W 75M | 57 | 370 | 1 | kompl. |
| 1093456 | 1100W 87M | 48 | 480 | 1 | kompl. |
| 1093457 | 1550W 124M | 34 | 580 | 1 | kompl. |
| 1093458 | 1850W 143M | 29 | 620 | 1 | kompl. |

Uponor Comfort E kaabli kinniti



| Art. nr. | 2. pak. | pakend | UOM |
|----------------|---------|--------|-----|
| 1093460 | 20 | 1 | tk |

Uponor Comfort E DRY

Kirjeldus

- Elektriline lahtirullitav Al-kilega küttematt kuivpaigalduseks
- paigaldatakse vahetult soojusisolatsioonile parketi, laminaadi või plastkatte alla
- mõlemad pooled kaetud Al-kilega
- laius 0,5m
- FEP elektrilise isolatsiooniga küttekaabel
- 3m ühenduskaabel
- komplektis Al-teibi ribad
- komplektis kaitsehülss põranda andurile

Kasutusala

- Elektriline põrandaküte
- paigaldatakse vahetult soojusisolatsioonile parketi, laminaadi või plastkatte alla

Sertifitseerimine

- CE; EAC
- IPX7

Uponor Comfort E AL-kilega küttematt

- küttevõimsus 140 W/m²



| Art. nr. | Dimension | Resistance Ohm | Q W | L m | B m | A m ² | uPoints | 2. pak. | pakend | UOM |
|----------------|-----------|----------------|------|-----|-----|------------------|---------|---------|--------|--------|
| 1088684 | 140-1 | 378 | 140 | 2 | 0,5 | 1 | 140 | 50 | 1 | kompl. |
| 1088685 | 140-2 | 189 | 280 | 4 | 0,5 | 2 | 200 | 50 | 1 | kompl. |
| 1088686 | 140-3 | 126 | 420 | 6 | 0,5 | 3 | 260 | 50 | 1 | kompl. |
| 1088687 | 140-4 | 94 | 560 | 8 | 0,5 | 4 | 310 | 35 | 1 | kompl. |
| 1088688 | 140-5 | 76 | 700 | 10 | 0,5 | 5 | 370 | 35 | 1 | kompl. |
| 1088689 | 140-6 | 63 | 840 | 12 | 0,5 | 6 | 440 | 35 | 1 | kompl. |
| 1088690 | 140-7 | 54 | 980 | 14 | 0,5 | 7 | 500 | 20 | 1 | kompl. |
| 1088691 | 140-8 | 47 | 1120 | 16 | 0,5 | 8 | 540 | 20 | 1 | kompl. |
| 1088692 | 140-9 | 42 | 1260 | 18 | 0,5 | 9 | 570 | 20 | 1 | kompl. |
| 1088693 | 140-10 | 38 | 1400 | 20 | 0,5 | 10 | 600 | 20 | 1 | kompl. |

Uponor Comfort E

Uponor Comfort E AL-kile soojustus

- isolatsiooniplaat Uponor Comfort E AL-kilega küttemati soojuskadude vähendamiseks
- 5mm volditud XPS paneelid
- ~0,15m²K/W



| Art. nr. | Dimension | l mm | b mm | 2. pak. | pakend | UOM |
|----------|-----------|---------|---------|---------|--------|----------------|
| 1088707 | 5mm | 6.25 | 0.8 | 200 | 5 | m ² |

Uponor Comfort E Termostaadid

Kirjeldus

- 230V

Kasutusala

- Elektrilise põrandakütte juhtimisseadmed
- küttematile
- Al-kilega küttematile

Sertifitseerimine

- CE; EAC

Uponor Comfort E reguleerkettaga termostaat set T-85

- reguleerkettaga termostaat T-85 Uponor elektrilise põrandakütte juhtimiseks, põrandaanuriga
- paigaldatav paigaldustoosile
- On / Off lülitus
- temperatuuri vahemik 5 - 30°C
- lülitusvool 16A
- korpuse kaitseklass IP30



| Art. nr. | Dimension | pakend | UOM |
|----------|-----------|--------|--------|
| 1088705 | 230V | 1 | kompl. |

Uponor Comfort E programmeeritav digitaalne termostaat flush Set T-86

- Digitaalne programmeeritav termostaat T-86 Uponor elektrilise põrandakütte juhtimiseks, põrandaanuriga
- süvitatud seinapaigaldus
- jooksva režiimi oleku kuva
- energiasäästu funktsioon
- puhkuse režiim
- temperatuuri vahemik 5 - 35°C
- käivitusvool 16mA
- korpuse kaitseklass IP20



| Art. nr. | Dimension | pakend | UOM |
|----------|-----------|--------|--------|
| 1088819 | 230V | 1 | kompl. |

Uponor Comfort E

Uponor Comfort E programmeeritav digitaalne termostaat flush Set T-87IF

- Digitaalne programmeeritav termostaat T-87IF Uponor elektrilise põrandakütte juhtimiseks, põrandaanduriga
- süvistatud seinapaigaldus või raami
- jooksva režiimi oleku kuva
- põranda andur min/max piirajaga
- energia maksumuse arvutus
- püsiva temperatuuri seade optimaalseks mugavuseks ja energiasäästuks
- programmeeritav puhkuse režiim
- võõra kasutuse kaitse
- temperatuuri vahemik 5 - 30°C
- käivitusvool 16A
- korpuse kaitseklass IP30



| Art. nr. | Dimension | pakend UOM | |
|----------------|-----------|------------|--------|
| 1088706 | 230V | 1 | kompl. |

Uponor Ecoflex Thermo

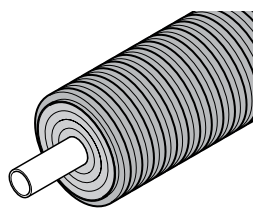

Uponor Ecoflex Thermo torud on sertifitseeritud vastavalt standardile EN 15632.

Kasutatakse kütte- ja jahutussüsteemides. Thermo Single kasutatakse suurte vooluhulkade korral. Thermo Twin - peale- ja tagasivool

Eelised

- Suurepärase painduvus
- Lihtne paigaldada
- Hea energeetiline efektiivsus
- Kestev: vähemalt 30 aastat
- Tellitav soovitud pikkuses
- Sertifitseeritud süsteem

ühes kaitsekestas.



Kirjeldus

- Painduv, eelisoleeritud isekompenseeruv plasttoru süsteem vast. EN 15632
- Voolutoru: ristseotud polüetüleenitoru (PE-Xa), vast. EN ISO 15875, naturaalse värvusega, rõhuklass PN 6 (SDR 11), hapniku difusiooni tõke vast. EN 15632
- Isolatsiooni materjal: suletud pooridega PE-X vaht, püsivalt elastne, vananemiskindel
- Kaitsekest: gofreeritud polüetüleen (HDPE)

Kasutusala

- Kütte ja jahutusvee transpordiks maaalusel paigaldusel.
- Kütte töötemperatuur 80°C, vast. EN 15632
- Lühiajaline avariitemperatuur 95°C
- Katsetatud staatiline liikluskoormuse taluvus 60 tonni

Sertifitseerimine

- Vastavustunnistused kohalikul esindajalt

Uponor Ecoflex Thermo Single

- Küte ja jahutus
- Üks hapniku difusioonitõkkega PE-Xa voolutoru
- Max. 6 bar / 95°C
- PEX vaht, HDPE kaitsekest

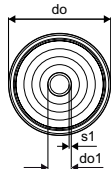

| Art. nr. | Dimension | do mm | do1 mm | s1 mm | R m | Weight kg | pakend UOM |
|----------------|--------------|----------|-----------|----------|--------|--------------|------------|
| 1018110 | 32x2,9/140 | 140 | 32 | 2,9 | 0,300 | 1,310 | 200 m |
| 1018111 | 40x3,7/175 | 175 | 40 | 3,7 | 0,350 | 2,200 | 200 m |
| 1018112 | 50x4,6/175 | 175 | 50 | 4,6 | 0,450 | 2,400 | 200 m |
| 1018113 | 63x5,8/175 | 175 | 63 | 5,8 | 0,550 | 2,800 | 200 m |
| 1018114 | 75x6,8/200 | 200 | 75 | 6,8 | 0,800 | 3,740 | 100 m |
| 1018115 | 90x8,2/200 | 200 | 90 | 8,2 | 1,100 | 4,200 | 100 m |
| 1018116 | 110x10,0/200 | 200 | 110 | 10 | 1,200 | 5,240 | 100 m |
| 1083868 | 125x11,4/250 | 250 | 125 | 11,4 | 1,400 | 7,250 | 120 m |

Uponor Ecoflex Thermo

Uponor Ecoflex Thermo Twin

- Küte ja jahutus
- Kaks hapniku difusioonitõkkega PE-Xa voolutoru
- Max. 6 bar / 95°C
- Värviline siseprofiil eraldab peale- ja tagasivoolu torud
- PEX vaht, HDPE kaitsekest

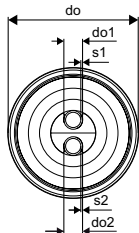

| Art. nr. | Dimension | do mm | do1 mm | do2 mm | s1 mm | s2 mm | R m | Weight kg | pakend | UOM |
|----------------|---------------|----------|-----------|-----------|----------|----------|--------|--------------|--------|-----|
| 1018134 | 2x25x2,3/175 | 175 | 25 | 25 | 2,3 | 2,3 | 0,500 | 2,200 | 200 | m |
| 1018135 | 2x32x2,9/175 | 175 | 32 | 32 | 2,9 | 2,9 | 0,600 | 2,400 | 200 | m |
| 1018136 | 2x40x3,7 /175 | 175 | 40 | 40 | 3,7 | 3,7 | 0,800 | 2,600 | 200 | m |
| 1018137 | 2x50x4,6/200 | 200 | 50 | 50 | 4,6 | 4,6 | 1,000 | 3,500 | 100 | m |
| 1018138 | 2x63x5,8/200 | 200 | 63 | 63 | 5,8 | 5,8 | 1,200 | 4,550 | 100 | m |
| 1088276 | 2x75x6,8/250 | 250 | 75 | 75 | 6,8 | 6,8 | 1,400 | 6,500 | 100 | m |

Uponor Ecoflex Thermo Mini

- Küte ja jahutus
- Üks hapniku difusioonitõkkega PE-Xa voolutoru
- Max. 6 bar / 95°C
- PEX vaht, HDPE kaitsekest

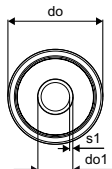

| Art. nr. | Dimension | do mm | do1 mm | s1 mm | R m | Weight kg | 2. pak. | pakend | UOM |
|----------------|-----------------|----------|-----------|----------|--------|--------------|---------|--------|-----|
| 1018132 | 25x2,3/68 | 68 | 25 | 2,3 | 0,200 | 0,500 | | 200 | m |
| 1018133 | 32x2,9/68 | 68 | 32 | 2,9 | 0,250 | 0,550 | | 200 | m |
| 1095574 | 32X2,9/68 L=25M | 68 | 32 | 2,9 | | | 50 | 25 | m |
| 1095575 | 32X2,9/68 L=50M | 68 | 32 | 2,9 | | | 50 | 50 | m |

Uponor Ecoflex Thermo PRO

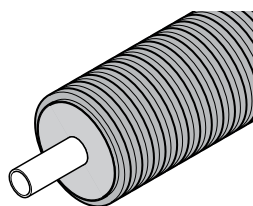

Kütte- ja jahutussüsteemidele. Ühe voolutoruga Thermo PRO suurtele vooluhulkadele.

Thermo PRO ka peale- ja tagasivoolu torudega ühes kaitsekooses

Eelised

- Suurepärase paindumus
- Lihtne paigaldada
- Hea energeetiline efektiivsus
- Kestev: vähemalt 30 aastat
- Tellitav soovitud pikkuses
- Sertifitseeritud süsteem



Kirjeldus

- Painduv, eelisoleeritud isekompenseeruv plasttoru süsteem vast. EN 15632
- Voolutoru: ristseotud polüetüleenitoru (PE-Xa), vast. EN ISO 15875, naturaalse värvusega, rõhuklass PN 6 (SDR 11), hapniku difusiooni tõke vast. EN 15632
- Isolatsiooni materjal: elastne polüüretaanvaht (PUR), väliskihis õhuke kiht suletud pooridega PE-X vaht
- Kaitsekest: gofreeritud polüetüleen (HDPE)

Kasutusala

- Kütte ja jahutusvee transpordiks maaalusel paigaldusel.
- Kütte töötemperatuur 80°C, vast. EN 15632
- Lühiajaline avariitemperatuur 95°C
- Katsetatud staatiline liikluskoormuse taluvus 60 tonni

Sertifitseerimine

- Vastavustunnistused kohalikult esindajalt

Uponor Ecoflex Thermo PRO Single

- Küte ja jahutus
- Üks hapniku difusioonitõkkega PE-Xa voolutoru
- Max. 6 bar / 95°C
- PUR vaht, HDPE kaitsekest

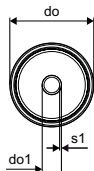

| Art. nr. | Dimension | do mm | do1 mm | s1 mm | R m | Weight kg | pakend | UOM |
|----------------|--------------|----------|-----------|----------|--------|--------------|--------|-----|
| 1087379 | 40X3,7/175 | 175 | 40 | 3,7 | 0,700 | 3,070 | 150 | m |
| 1087384 | 50X4,6/175 | 175 | 50 | 4,6 | 0,700 | 2,960 | 150 | m |
| 1087385 | 63X5,8/175 | 175 | 63 | 5,8 | 0,700 | 3,260 | 150 | m |
| 1087386 | 63X5,8/200 | 200 | 63 | 5,8 | 0,800 | 3,840 | 100 | m |
| 1087387 | 75X6,8/175 | 175 | 75 | 6,8 | 0,800 | 3,600 | 150 | m |
| 1087388 | 75X6,8/200 | 200 | 75 | 6,8 | 0,900 | 4,180 | 100 | m |
| 1087389 | 90X8,2/200 | 200 | 90 | 8,2 | 1,100 | 4,700 | 100 | m |
| 1087390 | 110X10,0/200 | 200 | 110 | 10 | 1,200 | 5,510 | 100 | m |

Uponor Ecoflex Thermo PRO

Uponor Ecoflex Thermo PRO Twin

- Küte ja jahutus
- Kaks hapniku difusioonitõkkega PE-Xa voolutoru
- Max. 6 bar / 95°C
- Üks märgistatud toru eristab peale- ja tagasivoolu
- PUR vaht, HDPE kaitsekest

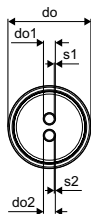

| Art. nr. | Dimension | do mm | do1 mm | do2 mm | s1 mm | s2 mm | R m | Weight kg | pakend | UOM |
|----------------|---------------|----------|-----------|-----------|----------|----------|--------|--------------|--------|-----|
| 1087392 | 2X25X2,3 /145 | 145 | 25 | 25 | 2,3 | 2,3 | 0,600 | 1,970 | 240 | m |
| 1087393 | 2X25X2,3 /175 | 175 | 25 | 25 | 2,3 | 2,3 | 0,700 | 2,710 | 150 | m |
| 1087394 | 2X32X2,9 /145 | 145 | 32 | 32 | 2,9 | 2,9 | 0,600 | 2,150 | 240 | m |
| 1087395 | 2X32X2,9 /175 | 175 | 32 | 32 | 2,9 | 2,9 | 0,800 | 2,870 | 150 | m |
| 1087396 | 2X40X3,7 /175 | 175 | 40 | 40 | 3,7 | 3,7 | 0,800 | 3,130 | 150 | m |
| 1087397 | 2X40X3,7 /200 | 200 | 40 | 40 | 3,7 | 3,7 | 1,000 | 3,700 | 100 | m |
| 1087398 | 2X50X4,6 /200 | 200 | 50 | 50 | 4,6 | 4,6 | 1,100 | 4,080 | 100 | m |
| 1087399 | 2X63X5,8 /200 | 200 | 63 | 63 | 5,8 | 5,8 | 1,200 | 4,690 | 100 | m |

Uponor Ecoflex Aqua

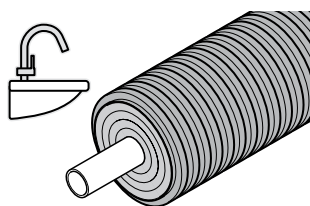

Uponor Ecoflex Aqua torusid kasutatakse hügieenilise energiasäästliku lahenduse-
na sooja tarbevee jaotusvõr-
kudes

Eelised

- Puhas ja hügieeniline
- Suurepärane painduvus
- Lihtne paigaldus
- Head soojusisolatsiooni näitajad
- Kestev: vähemalt 30 aastat
- Täielik valik liitmikke ja tarvikuid



Kirjeldus

- Painduv, eelisoleeritud isekompenseeruv plasttoru süsteem vast. EN 15632
- Voolutoru: ristseotud polüetüleenitoru (PE-Xa), vast. EN ISO 15875, naturaalse värvusega, rõhuklass PN 10 (SDR 7,4)
- Isolatsiooni materjal: suletud pooridega PE-X vaht, püsivalt elastne, vananemiskindel
- Kaitsekest: gofreeritud polüetüleen (HDPE)

Kasutusala

- Sooja tarbevee transpordiks maaalusel paigaldusel.
- Tarbevee töötemperatuur 70°C, vast. EN 15875
- Lühiajaline avariitemperatuur 95°C
- Katsetatud staatiline liikluskoormuse taluvus 60 tonni

Sertifitseerimine

- Vastavustunnistused kohalikult esindajalt

Uponor Ecoflex Aqua Single

- Soe tarbevesi
- Üks PE-Xa voolutoru
- Max. 10 bar / 95°C
- PEX vaht, HDPE kaitsekest

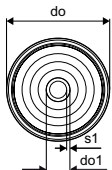

| Art. nr. | Dimension | do mm | do1 mm | s1 mm | R m | Weight kg | pakend UOM |
|-----------------|--------------|----------|-----------|----------|--------|--------------|------------|
| 1018118 | 32x4,4/140 | 140 | 32 | 4,4 | 0,400 | 1,420 | 200 m |
| 1018119 | 40x5,5/175 | 175 | 40 | 5,5 | 0,450 | 2,400 | 200 m |
| 1018120 | 50x6,9/175 | 175 | 50 | 6,9 | 0,550 | 2,700 | 200 m |
| 1018121 | 63x8,6/175 | 175 | 63 | 8,6 | 0,650 | 3,200 | 200 m |
| 1018122* | 75x10,3/200 | 200 | 75 | 10,3 | 0,900 | 4,340 | 100 m |
| 1018123* | 90x12,3/200 | 200 | 90 | 12,3 | 1,200 | 5,300 | 100 m |
| 1036036* | 110x15,1/200 | 200 | 110 | 15,1 | 1,300 | 6,500 | 100 m |

* 1018122, 1018123, 1036036 tarneaeg võib olla pikem

Uponor Ecoflex Aqua

Uponor Ecoflex Aqua Twin

- Soe tarbevesi tsirkulatsiooniga
- Kaks PE-Xa voolutoru
- Max. 10 bar / 95°C
- Värviline siseprofiil eraldab pealevoolu ja tsirkulatsiooni torud
- PEX vaht, HDPE kaitsekest

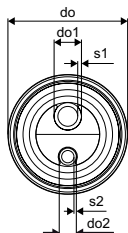

| Art. nr. | Dimension | do mm | do1 mm | do2 mm | s1 mm | s2 mm | R m | Weight kg | pakend | UOM |
|-----------------|-------------------|----------|-----------|-----------|----------|----------|--------|--------------|--------|-----|
| 1084885* | 25x3,5-20x2,8/140 | 140 | 25 | 20 | 3,5 | 2,8 | 0,650 | 1,750 | 200 | m |
| 1084886* | 32x4,4-20x2,8/175 | 175 | 32 | 20 | 4,4 | 2,8 | 0,700 | 2,400 | 200 | m |
| 1018140 | 32x4,4-25x3,5/175 | 175 | 32 | 25 | 4,4 | 3,5 | 0,700 | 2,200 | 200 | m |
| 1018141* | 40x5,5-25x3,5/175 | 175 | 40 | 25 | 5,5 | 3,5 | 0,900 | 2,450 | 200 | m |
| 1044015* | 40x5,5-32x4,4/175 | 175 | 40 | 32 | 5,5 | 4,4 | 0,900 | 2,800 | 200 | m |
| 1034188 | 50x6,9-32x4,4/175 | 175 | 50 | 32 | 6,9 | 4,4 | 1,000 | 3,100 | 200 | m |
| 1044016* | 50x6,9-40x5,5/200 | 200 | 50 | 40 | 6,9 | 5,5 | 1,000 | 3,500 | 100 | m |

* 1084885, 1084886, 1018141, 1044015, 1044016 tarneaeg võib olla pikem

Uponor Ecoflex Quattro

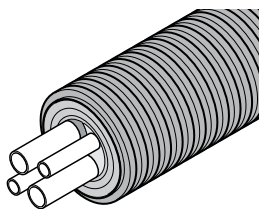

Uponor Ecoflex Quattro on kompleksne torusüsteem, kus ühes kaitsekestas on eelisoleerituna 2 kütte ja 2 sooja tarbevee toru

Eelised

- Kuluefektiivne kõik ühes paigaldus
- Energeetiliselt efektiivne
- Lihtne paigaldus
- Korrosioonikindel
- Kestev: vähemalt 30 aastat



Kirjeldus

- Painduv, eelisoleeritud isekompenseeruv plasttoru süsteem vast. EN 15632
- Voolutoru: ristseotud polüetüleentoru (PE-Xa), vast. EN ISO 15875, naturaalse värvusega, rõhuklass PN 6 (SDR 11) ja PN10 (SDR 7,4), kütetoru hapniku difusiooni tõke vast. EN 15632
- Isolatsiooni materjal: suletud pooridega PE-X vaht, püsivalt elastne, vananemiskindel
- Kaitsekest: gofreeritud polüetüleen (HDPE)

Kasutusala

- Kütte ja sooja tarbevee transpordiks maaalusel paigaldusel.
- Kütte töötemperatuur 80°C, vast. EN 15632
- Tarbevee temperatuur 70°C, vast. EN ISO 15875
- Lühiajaline avariitemperatuur 95°C
- Katsetatud staatiline liikluskoormuse taluvus 60 tonni

Sertifitseerimine

- Vastavustunnistused kohalikul esindajalt

Uponor Ecoflex Quattro

- Küte ja soe tarbevesi tsirkulatsiooniga
- Neli PE-Xa voolutoru
- Max. 6 bar küte / 10 bar tarbevesi / 95°C
- PEX vaht, HDPE kaitsekest
- värviline siseprofiil eristab peale- ja tagasivoolu torud

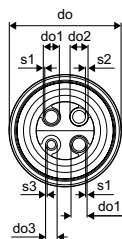

| Art. nr. | Dimension | do mm | do1 mm | do2 mm | do3 mm | s1 mm | s2 mm | s3 mm | R m | Weight kg | pakend | UOM |
|-----------------|----------------------------|----------|-----------|-----------|-----------|----------|----------|----------|--------|--------------|--------|-----|
| 1084887* | 2x25x2,3-25x3,5-20x2,8/175 | 175 | 25 | 25 | 20 | 2,3 | 3,5 | 2,8 | 0,800 | 2,300 | 200 | m |
| 1084888* | 2x32x2,9-25x3,5-20x2,8/175 | 175 | 32 | 25 | 20 | 2,9 | 3,5 | 2,8 | 0,800 | 2,500 | 200 | m |
| 1084889* | 2x32x2,9-32x4,4-20x2,8/175 | 175 | 32 | 32 | 20 | 2,9 | 4,4 | 2,8 | 0,800 | 2,900 | 200 | m |
| 1018149 | 2x32x2,9-32x4,4-25x3,5/175 | 175 | 32 | 32 | 25 | 2,9 | 4,4 | 3,5 | 0,800 | 2,780 | 200 | m |
| 1084891* | 2x40x3,7-32x4,4-20x2,8/200 | 200 | 40 | 32 | 20 | 3,7 | 4,4 | 2,8 | 1,000 | 3,500 | 100 | m |
| 1084890 | 2x40x3,7-40x5,5-25x3,5/200 | 200 | 40 | 40 | 25 | 3,7 | 5,5 | 3,5 | 1,000 | 3,600 | 100 | m |

* 1084887, 1084888, 1084889, 1084891 tarneaeg võib olla pikem

Uponor Ecoflex Quattro Midi

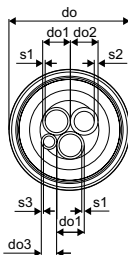

| Art. nr. | Dimension | do mm | do1 mm | do2 mm | do3 mm | s1 mm | s2 mm | s3 mm | R m | Weight kg | pakend | UOM |
|----------------|----------------------------|----------|-----------|-----------|-----------|----------|----------|----------|--------|--------------|--------|-----|
| 1086836 | 2x25x2,3-25x3,5-20x2,8/140 | 140 | 25 | 25 | 20 | 2,3 | 3,5 | 2,8 | 0,650 | 1,840 | 200 | m |
| 1086837 | 2x32x2,9-25x3,5-20x2,8/140 | 140 | 32 | 25 | 20 | 2,9 | 3,5 | 2,8 | 0,700 | 2,000 | 200 | m |

NEW

Uponor Ecoflex Supra

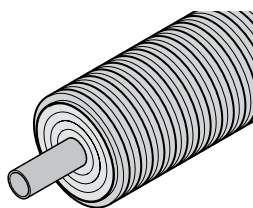

Eelised

- Hügeeniline
- Kerge paigaldus, suurepärase painduvus
- Korrosioonikindel
- Sobib standardliitmikuga



Kirjeldus

- Painduv, eelisoleeritud plasttorusüsteem
- Voolutoru: polüetüleen PE 100, must sinise triibuga, PN 16 (SDR 11)
- Isolatsioonimaterjal: suletud pooridega PE-X vaht, püsivalt elastne, vananemiskindel
- Väliskest: gofreeritud polüetüleen (HDPE)

Kasutusala

- Külma tarbevee või jahutusvee transpordik maaalusel paigaldusel.
- Töötemperatuur +20°C
- Katsetatud staatiline liikluskoormuse taluvus 60 tonni

Sertifitseerimine

- Vastavustunnistused kohalikul esindajalt

Uponor Ecoflex Supra

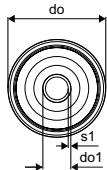

| Art. nr. | Dimension | do mm | do1 mm | s1 mm | R | pakend | UOM |
|----------------|--------------|----------|-----------|----------|------|--------|-----|
| 1095722 | 25x2,3/68 | 68 | 25 | 2,3 | 0.2 | 200 | m |
| 1095723 | 32x2,9/68 | 68 | 32 | 2,9 | 0.25 | 200 | m |
| 1095724 | 40x3,7/140 | 140 | 40 | 3,7 | 0.3 | 200 | m |
| 1095725 | 50x4,6/140 | 140 | 50 | 4,6 | 0.4 | 200 | m |
| 1095726 | 63x5,8/140 | 140 | 63 | 5,8 | 0.5 | 200 | m |
| 1095727 | 75x6,8/175 | 175 | 75 | 6,8 | 0.6 | 150 | m |
| 1095728 | 90x8,2/175 | 175 | 90 | 8,2 | 0.7 | 100 | m |
| 1095729 | 110x10,0/200 | 200 | 110 | 10 | 1.2 | 100 | m |

Uponor Ecoflex Supra PLUS

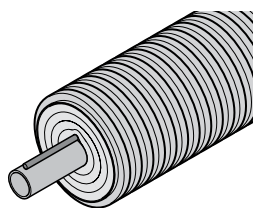

Uponor Ecoflex Supra PLUS kasutatakse külma tarbevee ühendusteks. Isereguleeruva külmumisvastase kaabliga, mida juhitakse spetsiaalse juhtseadmega. Kasutatav ka väga madalatel välistemperatuuridel

Eelised

- Vastupidav ja hooldevaba
- Lihtsad elektrilised ühendused
- Puhas ja hügieeniline
- Korrosioonikindel
- Energiasäästlik külmumiskaitse
- Võib kasutada ka survekandisatsioonina



Kirjeldus

- Painduv, eelisoleeritud plasttorusüsteem
- Voolutoru: polüetüleen PE80, PN 12,5 (SDR 11) või PE100, PN 16 (SDR 11), must sinise triibuga või PE 100, PN 16 (SDR 11), must sinise kattekihiga
- Kaabel: isereguleeruv külmumisvastane kaabel, nimivõimsus 10W/m, 5°C, maksimaalne pikkus ühest elektri ühenduspunkti 150 m
- Paigaldustoru: PE toruke temperatuuri anduri sisestamiseks.
- Isolatsioon: suletud pooridega PE-X vaht, püsivalt elastne, vananemiskindel
- Kaitsekest: gofreeritud polüetüleen (HDPE)

Kasutusala

- Külma tarbevee transpordiks külmumisriskiga kohtades maaalusel paigaldusel.
- Töötemperatuur +20°C
- Katsetatud staatiline liikluskoormuse taluvus 60 tonni

Sertifitseerimine

- Vastavustunnistused kohalikul esindajalt

Uponor Ecoflex Supra PLUS

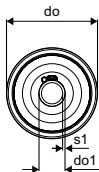

| Art. nr. | Dimension | do mm | do1 mm | s1 mm | R mm | pakend UOM |
|-----------------------|----------------------|----------|-----------|----------|---------|------------|
| NEW 1095730 | 25x2,3/68 1x10W/m | 68 | 25 | 2,3 | 0,5 | 150 m |
| NEW 1095731 | 32x2,9/68 1x10W/m | 68 | 32 | 2,9 | 0,5 | 150 m |
| NEW 1095733 | 40x3,7/90 1x10W/m | 90 | 40 | 3,7 | 0,7 | 150 m |
| NEW 1095734 | 40x3,7/140 1x10W/m | 140 | 40 | 3,7 | 0,8 | 150 m |
| NEW 1095735 | 50x4,6/90 1x10W/m | 90 | 50 | 4,6 | 0,8 | 150 m |
| NEW 1095736 | 50x4,6/140 1x10W/m | 140 | 50 | 4,6 | 0,8 | 150 m |
| NEW 1095737 | 63x5,8/140 1x10W/m | 140 | 63 | 5,8 | 0,8 | 150 m |
| NEW 1095738 | 75x6,8/175 1x10W/m | 175 | 75 | 6,8 | 1,0 | 150 m |
| NEW 1095739 | 90x8,2/200 1x10W/m | 200 | 90 | 8,2 | 1,2 | 100 m |
| NEW 1095740 | 110x10,0/200 1x10W/m | 200 | 110 | 10 | 1,2 | 100 m |

Uponor Ecoflex Supra PLUS

Uponor Ecoflex Supra PLUS ühendus ja lõpukomplekt

- Supra PLUS toru ühendus ja lõpupakett
- Juhtseade max. 150m pikkusele külmumisvastasele kaablile
- Andur koos 5m kaabliga
- S1 kaabli ühenduse ja lõpu komplekt
- Kaks kummist otsakatet

NB! Ei sisalda voolutoru liitmikku



| Art. nr. | Dimension | d mm | do mm | Weight kg | pakend UOM | |
|----------------|--------------|----------|----------|--------------|------------|----|
| 1048697 | 25+32/68 | 25+32 | 68 | 100,000 | 1 | tk |
| 1048698 | 40+50/90 | 40+50 | 90 | 1,080 | 1 | tk |
| 1048699 | 40+50+63/140 | 40+50+63 | 140 | 1,530 | 1 | tk |
| 1048700 | 75/175 | 75 | 175 | 1,640 | 1 | tk |
| 1048702 | 90+110/200 | 90+110 | 200 | 1,920 | 1 | tk |

Uponor Ecoflex Supra PLUS juhtseade 150

- Supra PLUS kütte juhtseade
- kuni max. 150m külmumisvastasele kaablile
- komplektis andur 5m kaabliga

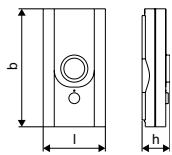

| Art. nr. | l mm | b mm | h mm | Weight kg | pakend UOM | |
|----------------|---------|---------|---------|--------------|------------|----|
| 1048703 | 87 | 165 | 39 | 0,300 | 1 | tk |

Uponor Ecoflex Supra PLUS harukomplekt

- Kaitsekesta kolmiku pakett
- ABS isolatsioonikoorikud koos isolatsiooni ja üleminekutega
- S2 komponendid kaabli kolmikühenduseks
- Liikluskoormus kuni 60 tonni

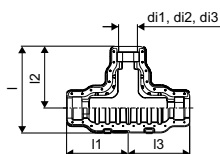

| Art. nr. | Dimension | l mm | l1 mm | l2 mm | l3 mm | d1 mm | d2 mm | d3 mm | Weight kg | 2. pak. | pakend UOM | |
|----------------|-------------|---------|----------|----------|----------|----------|----------|----------|--------------|---------|------------|----|
| 1061641 | 140/90/68 | 666 | 470 | 470 | 470 | 140 | 90 | 68 | 9,880 | 5 | 1 | tk |
| 1061642 | 200/175/140 | 786 | 532 | 562 | 562 | 200 | 175 | 140 | 13,630 | 3 | 1 | tk |

Uponor Wipex

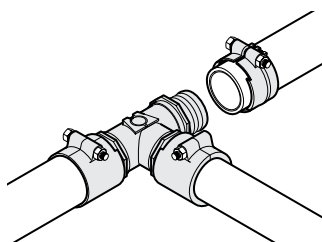

Kasutatakse PEX-torude ühendamiseks sooja ja külma vee ning kütte lokaal- ja tsentraalvõrkudes. Läbimõõtudele 25 - 110 mm rõhuklassiga PN 6 ja PN 10. Ühenduste tihendamine O-tihenditega.

Kõikidele Ecoflex torudele sobivad ka Q&E liitmikud (vt. Q&E jaotist kataloogis)

Eelised

- Lihtne ühendada, pakkimiseta
- korrosioonikindel
- Puhas ja hügieeniline
- Kestev
- Materjal: kõrgekvaliteediline DR messing



Kirjeldus

- Wipex liitmikud korrosioonikindlast messingist, tsingikaovaba vast. DIN EN ISO 6509, roostevabast terasest pingutuspolst.
- Wipex liitmiku ja muude ühenduskomponentide tihendamine O-tihendiga
- Pingutuspolsti komplekt roostevaba teras
- Eelavatud klambriga, läbimõõtudele 63-110mm.
- Saadaval ka Q&E liitmikud kuni 75 mm vt. vastavat jaotist kataloogis!

Kasutusala

- Torusüsteemide Thermo, Aqua, Quattro, Supra, Supra PLUS ja Supra Standard ühenduste tegemiseks
- PE ja PE-Xa voolutorude liitmike ühendus: silindriline torukeere (VK)
- Saadaval ka Q&E liitmikud kuni 75mm.
- Max. töötemperatuur 95°C

Sertifitseerimine

- Vastavustunnistused kohalikult esindajalt

Uponor Wipex liitmik PN6

- PE-Xa või PE torude ühendamiseks
- Silindriline keere G^{1/2}, O-tihendiga
- Max. 6 bar / 95°C
- DR = tsingikaovaba messing

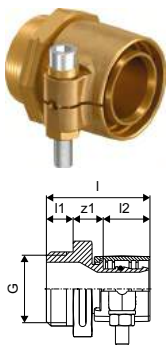

| Art. nr. | Dimension | l mm | l1 mm | l2 mm | G " | z1 mm | p bar | Weight kg | 2. pak. | pakend | UOM |
|----------|---------------|---------|----------|----------|--------|----------|----------|--------------|---------|--------|-----|
| 1018328 | 25x2,3-G1 | 47 | 12 | 21 | 1 | 14 | 6 | 0,200 | 40 | 1 | tk |
| 1018329 | 32x2,9-G1 | 52 | 12 | 26 | 1 | 14 | 6 | 0,300 | 20 | 1 | tk |
| 1018330 | 40x3,7-G1 1/4 | 61 | 16 | 30 | 1 1/4 | 15 | 6 | 0,500 | 10 | 1 | tk |
| 1018331 | 50x4,6-G1 1/4 | 68 | 16 | 37 | 1 1/4 | 16 | 6 | 0,700 | 10 | 1 | tk |
| 1018332 | 63x5,8-G2 | 84 | 20 | 47 | 2 | 18 | 6 | 1,200 | 8 | 1 | tk |
| 1018333 | 75x6,8-G2 | 92 | 20 | 51 | 2 | 21 | 6 | 1,500 | 6 | 1 | tk |
| 1018334 | 90x8,2-G3 | 105 | 24 | 60 | 3 | 22 | 6 | 2,400 | 4 | 1 | tk |
| 1018335 | 110x10,0-G3 | 118 | 24 | 72 | 3 | 22 | 6 | 3,500 | 3 | 1 | tk |

Uponor Wipex

Uponor Ecoflex liitmik PN6

- PE-Xa või PE torude ühendamiseks
- Silindriline keere R", pakitav
- Max. 6 bar / 95°C
- DR = tsingikaovaba messing

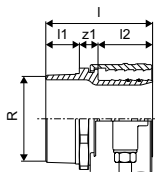

| Art. nr. | Dimension | l | l1 | l2 | G | R | z1 | p | Weight | pakend | UOM |
|----------------|-------------|-----|----|----|-----|---|----|-----|--------|--------|-----|
| | | mm | mm | mm | " | " | mm | bar | kg | | |
| 1078368 | 125x11,4-R4 | 137 | 43 | 70 | 3/4 | 4 | 24 | 6 | 5,240 | 1 | tk |

Uponor FPL-X surveliitmik DR PN 10

- FPL-X
- DR = tsingikaovaba messing

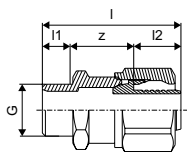

| Art. nr. | Dimension | l | l1 | l2 | G | z1 | Weight | 2. pak. | pakend | UOM |
|----------------|-------------|----|----|----|-----|----|--------|---------|--------|-----|
| | | mm | mm | mm | " | mm | kg | | | |
| 1085371 | 20x2,8-1"MT | 54 | 17 | 19 | 1/2 | 18 | 0,200 | 50 | 1 | tk |

Uponor Ecoflex surveliitmik PN10

- PE-Xa või PE torude ühendamiseks
- Kooniline keere R", pakitav
- Max. 10 bar / 95°C



NEW

| Art. nr. | Dimension | l | l1 | l2 | R | z1 | p | Weight | 2. pak. | pakend | UOM |
|----------------|-------------|----|----|----|-----|----|-----|--------|---------|--------|-----|
| | | mm | mm | mm | " | mm | bar | kg | | | |
| 1091505 | 20x2,8-3/4" | 46 | 16 | 13 | 3/4 | 17 | 10 | 0,121 | 10 | 1 | tk |

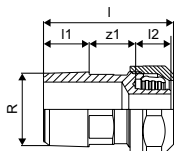

Uponor Wipex

Uponor Wipex liitmik PN10

- PE-Xa või PE torude ühendamiseks
- Silindriline keere G", O-tihendiga
- Max. 10 bar / 95°C
- DR = tsingikaovaba messing

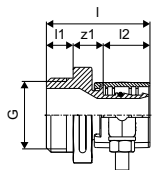

| Art. nr. | Dimension | l mm | l1 mm | l2 mm | G " | z1 mm | p bar | Weight kg | 2. pak. | pakend | UOM |
|-----------------|---------------|---------|----------|----------|--------|----------|----------|--------------|---------|--------|-----|
| 1018336 | 25x3,5-G1 | 47 | 12 | 21 | 1 | 14 | 10 | 0,200 | 40 | 1 | tk |
| 1018338 | 32x4,4-G1 | 52 | 12 | 26 | 1 | 14 | 10 | 0,300 | 20 | 1 | tk |
| 1018339 | 40x5,5-G1 1/4 | 61 | 16 | 30 | 1 1/4 | 16 | 10 | 0,500 | 10 | 1 | tk |
| 1018340 | 50x6,9-G1 1/4 | 68 | 16 | 37 | 1 1/4 | 16 | 10 | 0,700 | 10 | 1 | tk |
| 1018341 | 63x8,6-G2 | 84 | 20 | 46 | 2 | 18 | 10 | 1,200 | 8 | 1 | tk |
| 1018342 | 75x10,3-G2 | 92 | 20 | 51 | 2 | 21 | 10 | 1,500 | 6 | 1 | tk |
| 1018343* | 90x12,3-G3 | 105 | 24 | 59 | 3 | 22 | 10 | 2,400 | 4 | 1 | tk |
| 1023170* | 110x15,1-G3 | 118 | 24 | 72 | 3 | 22 | 10 | 3,200 | 3 | 1 | tk |

Uponor Wipex jätk PN6

- PE-Xa või PE torude jätkamiseks
- Max. 6 bar / 95°C
- DR = tsingikaovaba messing

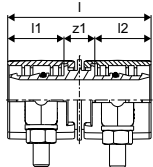

| Art. nr. | Dimension | l mm | l1 mm | l2 mm | z1 mm | p bar | Weight kg | 2. pak. | pakend | UOM |
|----------------|---------------|---------|----------|----------|----------|----------|--------------|---------|--------|-----|
| 1042972 | 25x2,3-25x2,3 | 54 | 21 | 21 | 12 | 6 | 0,180 | 30 | 1 | tk |
| 1042973 | 32x2,9-32x2,9 | 63 | 26 | 26 | 12 | 6 | 0,340 | 25 | 1 | tk |
| 1042980 | 40x3,7-40x3,7 | 71 | 29 | 29 | 13 | 6 | 0,540 | 15 | 1 | tk |
| 1042984 | 50x4,6-50x4,6 | 85 | 36 | 36 | 13 | 6 | 0,990 | 10 | 1 | tk |
| 1042981 | 63x5,8-63x5,8 | 105 | 46 | 46 | 13 | 6 | 1,530 | 5 | 1 | tk |
| 1042985 | 75x6,8-75x6,8 | 123 | 51 | 51 | 22 | 6 | 2,270 | 3 | 1 | tk |
| 1042986 | 90x8,2-90x8,2 | 142 | 59 | 59 | 24 | 6 | 3,500 | 4 | 1 | tk |
| 1042987 | 110x10-110x10 | 166 | 71 | 71 | 24 | 6 | 4,820 | 2 | 1 | tk |

Uponor Ecoflex jätk PN6

- PE-Xa või PE torude jätkamiseks
- Max. 6 bar / 95°C
- DR = tsingikaovaba messing

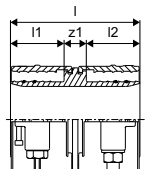

| Art. nr. | Dimension | l mm | l1 mm | l2 mm | z1 mm | p bar | Weight kg | pakend | UOM |
|----------------|-------------------|---------|----------|----------|----------|----------|--------------|--------|-----|
| 1078365 | 125x11,4-125x11,4 | 169 | 70 | 70 | 29 | 6 | 8,150 | 1 | tk |

Uponor Wipex

Uponor Wipex jätk PN10

- PE-Xa või PE torude jätkamiseks
- Max. 10 bar / 95°C
- DR = tsingikaovaba messing

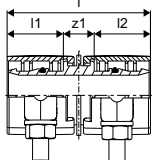

| Art. nr. | Dimension | l mm | l1 mm | l2 mm | z1 mm | p bar | Weight kg | 2. pak. | pakend | UOM |
|-----------------|---------------|---------|----------|----------|----------|----------|--------------|---------|--------|-----|
| 1042974 | 32x4,4-32x4,4 | 64 | 26 | 26 | 12 | 10 | 0,340 | 25 | 1 | tk |
| 1042979* | 40x5,5-40x5,5 | 72 | 30 | 29 | 13 | 10 | 0,540 | 15 | 1 | tk |
| 1042983* | 50x6,9-50x6,9 | 86 | 37 | 36 | 13 | 10 | 0,960 | 10 | 1 | tk |
| 1042982* | 63x8,6-63x8,6 | 106 | 47 | 46 | 13 | 10 | 0,160 | 4 | 1 | tk |

Uponor Wipex kolmik

- Silindriline keere G", tihendiga
- Max. 10 bar / 95°C
- DR = tsingikaovaba messing

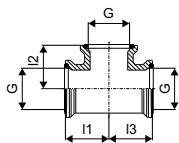

| Art. nr. | Dimension | l1 mm | l2 mm | l3 mm | G " | G1 " | G2 " | p bar | Weight kg | 2. pak. | pakend | UOM |
|----------------|----------------------|----------|----------|----------|--------|---------|---------|----------|--------------|---------|--------|-----|
| 1018345 | G1-G1-G1 | 35 | 35 | 35 | 1 | 1 | 1 | 6+10 | 0,31020 | | 1 | tk |
| 1018346 | G1 1/4-G1 1/4-G1 1/4 | 42 | 42 | 42 | 1 1/4 | 1 1/4 | 1 1/4 | 6+10 | 0,48010 | | 1 | tk |
| 1018347 | G2-G2-G2 | 55 | 55 | 55 | 2 | 2 | 2 | 6+10 | 1,0104 | | 1 | tk |
| 1018348 | G3-G3-G3 | 75 | 75 | 75 | 3 | 3 | 3 | 6+10 | 2,6403 | | 1 | tk |

Uponor Ecoflex kolmik

- Kooniline keere R", pakitav
- Max. 10 bar / 95°C
- DR = tsingikaovaba messing

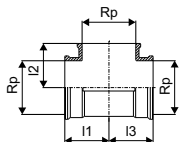

| Art. nr. | Dimension | l1 mm | l2 mm | l3 mm | Rp " | p bar | Weight kg | pakend | UOM |
|----------------|-------------|----------|----------|----------|---------|----------|--------------|--------|-----|
| 1078367 | Rp4-Rp4-Rp4 | 91 | 91 | 91 | 4 | 6 | 3,960 | 1 | tk |

Uponor Wipex

Uponor Wipex põlv

- Silindriline keere G^{1/2}, tihendiga
- Max. 10 bar / 95°C
- DR = tsingikaovaba messing

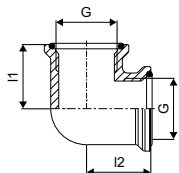

| Art. nr. | Dimension | l1 mm | l2 mm | G " | G1 " | p bar | Weight kg | 2. pak. | pakend | UOM |
|-----------------|---------------|----------|----------|--------|---------|----------|--------------|---------|--------|-----|
| 1018350 | G1-G1 | 35 | 35 | 1 | 1 | 6+10 | 0,270 | 20 | 1 | tk |
| 1018351 | G1 1/4-G1 1/4 | 42 | 42 | 1 1/4 | 1 1/4 | 6+10 | 0,450 | 15 | 1 | tk |
| 1018352 | G2-G2 | 55 | 55 | 2 | 2 | 6+10 | 0,940 | 5 | 1 | tk |
| 1018353* | G3-G3 | 75 | 75 | 3 | 3 | 6+10 | 2,200 | 2 | 1 | tk |

Uponor Ecoflex põlv

- Kooniline keere R^{1/2}, pakitav
- Max. 10 bar / 95°C
- DR = tsingikaovaba messing

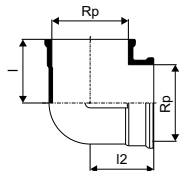

| Art. nr. | Dimension | l1 mm | l2 mm | Rp " | p bar | Weight kg | pakend | UOM |
|----------------|-----------|----------|----------|---------|----------|--------------|--------|-----|
| 1078366 | Rp4-Rp4 | 92 | 92 | 4 | 6 | 3,280 | 1 | tk |

Uponor Wipex muhv

- Silindriline keere G^{1/2}, tihendiga
- Max. 10 bar / 95°C
- DR = tsingikaovaba messing

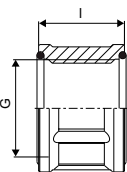

| Art. nr. | Dimension | l mm | G " | p bar | Weight kg | 2. pak. | pakend | UOM |
|-----------------|---------------|---------|--------|----------|--------------|---------|--------|-----|
| 1018355* | G1-G1 | 30 | 1 | 6+10 | 0,190 | 40 | 1 | tk |
| 1018356* | G1 1/4-G1 1/4 | 37 | 1 1/4 | 6+10 | 0,210 | 25 | 1 | tk |
| 1018357 | G2-G2 | 45 | 2 | 6+10 | 0,420 | 15 | 1 | tk |
| 1018358 | G3-G3 | 55 | 3 | 6+10 | 0,880 | 10 | 1 | tk |

Uponor Wipex

Uponor Wipex siirdmik välis x sise

- Silindriline keere G", tihendiga
- Max. 10 bar / 95°C
- DR = tsingikaovaba messing

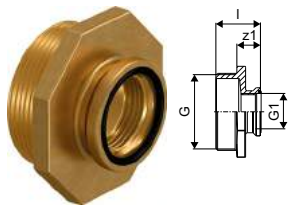

| Art. nr. | Dimension | l mm | G " | G1 " | z1 mm | p bar | Weight kg | 2. pak. | pakend | UOM |
|----------------|-----------|---------|--------|---------|----------|----------|--------------|---------|--------|-----|
| 1018368 | G1 1/4-G1 | 36 | 1 1/4 | 1 | 20 | 6+10 | 0,230 | 25 | 1 | tk |
| 1018371 | G2-G1 | 41 | 2 | 1 | 21 | 6+10 | 0,390 | 15 | 1 | tk |
| 1018372 | G2-G1 1/4 | 45 | 2 | 1 1/4 | 25 | 6+10 | 0,400 | 15 | 1 | tk |
| 1018374 | G3-G1 | 47 | 3 | 1 | 23 | 6+10 | 0,870 | 6 | 1 | tk |
| 1018375 | G3-G1 1/4 | 51 | 3 | 1 1/4 | 27 | 6+10 | 0,880 | 10 | 1 | tk |
| 1018376 | G3-G2 | 55 | 3 | 2 | 31 | 6+10 | 0,890 | 10 | 1 | tk |

Uponor Ecoflex siirdmik välis x sise

- Kooniline väliskeere R", pakitav
- Silindriline sisekeere G", tihendiga
- Max. 10 bar / 95°C
- DR = tsingikaovaba messing

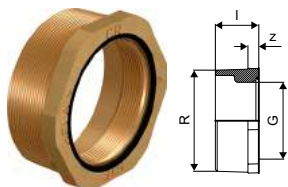

| Art. nr. | Dimension | l mm | G " | R " | z mm | p bar | Weight kg | 2. pak. | pakend | UOM |
|----------------|-----------|---------|--------|--------|---------|----------|--------------|---------|--------|-----|
| 1078369 | R4-G3 | 48 | 3 | 4 | 12 | 6 | 1,400 | 6 | 1 | tk |

Uponor Ecoflex äärrik

- Kooniline keere R", pakitav
- Max. 10 bar / 95°C
- Roostevaba teras

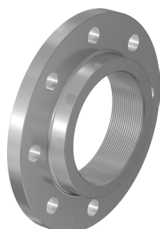

| Art. nr. | Dimension | no. tk | p bar | Weight kg | pakend | UOM |
|-----------------|----------------|-----------|----------|--------------|--------|-----|
| 1078370* | F100/8-180/Rp4 | 8 | 6 | 4,500 | 1 | tk |

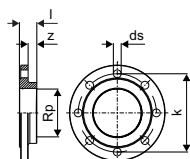

Uponor Wipex

Uponor Wipex

Pöördnippel

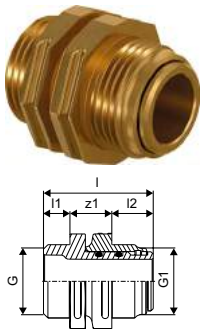

| Art. nr. | Dimension | l mm | l1 mm | l2 mm | G " | G1 " | z1 mm | p bar | Weight kg | 2. pak. | pakend | UOM |
|----------------|-----------|---------|----------|----------|--------|---------|----------|----------|--------------|---------|--------|-----|
| 1045455 | G1 | 50 | 12 | 19 | 1 | 1 | 19 | 6+10 | 0,260 | 20 | 1 | tk |
| 1045456 | G1 1/4-G1 | 50 | 12 | 21 | 1 | 1 1/4 | 17 | 6+10 | 0,350 | 20 | 1 | tk |
| 1045457 | G1 1/4 | 58 | 16 | 21 | 1 1/4 | 1 1/4 | 21 | 6+10 | 0,500 | 15 | 1 | tk |
| 1045458 | G2-G1 1/4 | 68 | 16 | 25 | 1 1/4 | 2 | 27 | 6+10 | 2,000 | 10 | 1 | tk |
| 1045459 | G2 | 74 | 20 | 25 | 2 | 2 | 29 | 6+10 | 1,170 | 10 | 1 | tk |
| 1045460 | G3-G2 | 82 | 24 | 25 | 3 | 2 | 33 | 6+10 | 1,790 | 3 | 1 | tk |
| 1045461 | G3 | 89 | 24 | 30 | 3 | 3 | 35 | 6+10 | 2,750 | 2 | 1 | tk |

Uponor Wipex ankurdusliitmik

- Silindriline keere G^a, tihendiga
- Max. 10 bar / 95°C
- DR = tsingikaovaba messing

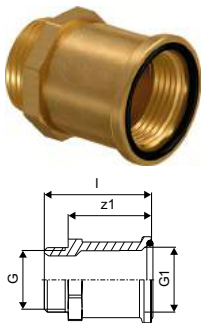

| Art. nr. | Dimension | l mm | G " | G1 " | z1 mm | p bar | Weight kg | 2. pak. | pakend | UOM |
|-----------------|-----------|---------|--------|---------|----------|----------|--------------|---------|--------|-----|
| 1018303 | G1 1/4 | 84 | 1 1/4 | 1 1/4 | 68 | 6+10 | 0,450 | 10 | 1 | tk |
| 1018304 | G2 | 93 | 2 | 2 | 73 | 6+10 | 0,780 | 5 | 1 | tk |
| 1018305* | G3 | 135 | 3 | 3 | 111 | 6+10 | 2,150 | 5 | 1 | tk |

Uponor Wipex nippel

- Silindriline keere G^a
- Max. 10 bar / 95°C
- DR = tsingikaovaba messing

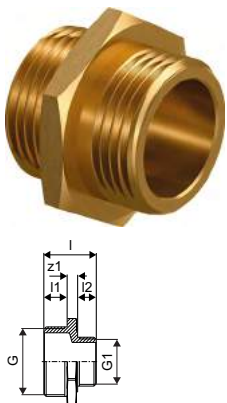

| Art. nr. | Dimension | l mm | l1 mm | l2 mm | G " | G1 " | z1 mm | p bar | Weight kg | 2. pak. | pakend | UOM |
|-----------------|-----------|---------|----------|----------|--------|---------|----------|----------|--------------|---------|--------|-----|
| 1009041* | G3xG1 1/4 | 51 | 24 | 16 | 3 | 1 1/4 | 11 | 6+10 | 0,940 | 10 | 1 | tk |
| 1009042 | G3xG2 | 55 | 24 | 20 | 3 | 2 | 11 | 6+10 | 0,950 | 10 | 1 | tk |

Uponor Wipex

Uponor Wipex siirdmik S-Press PN6

- PE-Xa ja Uponor MLC torude omavaheliseks ühendamiseks.
- Max. 6 bar
- DR = tsingikaovaba messing

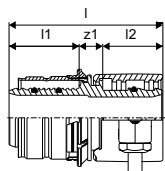

| Art. nr. | Dimension | l | l1 | l2 | do | s | z1 | p | Weight | 2. pak. | pakend | UOM |
|----------------|---------------|----|----|----|----|-----|----|-----|--------|---------|--------|-----|
| | | mm | mm | mm | mm | mm | mm | bar | kg | | | |
| 1060058 | 32x2,9-32x3,0 | 66 | 30 | 26 | 15 | 2,5 | 10 | 6 | 0,244 | 25 | 1 | tk |

Uponor Wipex siirdmik S-Press PN6

- PE-Xa ja Uponor MLC torude omavaheliseks ühendamiseks.
- Max. 6 bar / 95°C või 16 bar / 20°C
- DR = tsingikaovaba messing

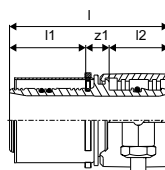

| Art. nr. | Dimension | l | l1 | l2 | do | s | z1 | p | Weight | 2. pak. | pakend | UOM |
|----------------|---------------|----|----|----|----|-----|----|-----|--------|---------|--------|-----|
| | | mm | mm | mm | mm | mm | mm | bar | kg | | | |
| 1060059 | 40x3,7-40x4,0 | 79 | 38 | 30 | 18 | 2,5 | 12 | 6 | 0,407 | 15 | 1 | tk |
| 1060060 | 50x4,6-50x4,5 | 86 | 38 | 37 | 18 | 2,5 | 12 | 6 | 0,655 | 10 | 1 | tk |

Uponor Ecoflex

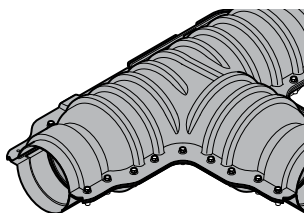

Süsteem sisaldab laia valikut kütte, jahutuse ja tarbevee võrkude ehitamiseks vajalikke tarvikuid. Kasutatakse koos Uponor Ecoflex torude ja liitmikega.

Eelised

- Komponentide praktiline ja kiire paigaldus
- Vastupidavad ja ohutud
- Täielik valik igaks vajaduseks



Kirjeldus

- Kõik tarvikud on korrosioonikindlad.

Kasutusala

- Ecoflex tarvikud sobivad kasutamiseks maaalusel paigaldusel.

Sertifitseerimine

- Vastavustunnistused kohalikul esindajalt

Uponor Ecoflex kummist otsakate Single

- Ühele voolutorule
- Kaitseb toru otsa niiskuse ja mustuse eest
- Veetihe kuni 0,3 bar
- EPDM kummist otsakate, roostevaba terasest klamber ja tihend

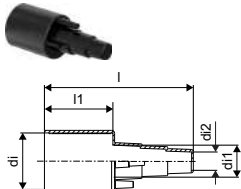

NEW

| Art. nr. | Dimension | l mm | l1 mm | d1 mm | d1 mm | d2 mm | do mm | no. tk | Weight kg | pakend | UOM |
|----------|------------------|---------|----------|----------|----------|----------|--------------|-----------|--------------|--------|-----|
| 1018316 | 25+32+40/68 | 174 | 80 | 66 | 37,4 | 21,4 | | 1 | 0,150 | 1 | tk |
| 1018315 | 25+28+32/140+145 | 184 | 90 | 132 | 30 | 21,4 | | 1 | 0,330 | 1 | tk |
| 1036248 | 32+40+50/90 | 174 | 80 | 87 | 47 | 28 | | 1 | 0,190 | 1 | tk |
| 1018313 | 32+40+50/175 | 184 | 90 | 166 | 47 | 28 | | 1 | 0,420 | 1 | tk |
| 1018314 | 40+50+63/140+145 | 184 | 90 | 132 | 59 | 34,5 | | 1 | 0,340 | 1 | tk |
| 1095801 | 63+75+90/140 | | | | | | 63+75+90/140 | | | 1 | tk |
| 1018312 | 63+75/175 | 184 | 90 | 166 | 70,3 | 56 | | 1 | 0,440 | 1 | tk |
| 1018310 | 75+90+110/200 | 184 | 90 | 190 | 103 | 67 | | 1 | 0,510 | 1 | tk |
| 1067757 | 125/200 | 142 | 90 | 190 | 117 | 109 | | 1 | 0,550 | 1 | tk |
| 1083869* | 90+110+125/250 | 200 | 90 | 235 | 117 | 81 | | 1 | 0,670 | 1 | tk |

Uponor Ecoflex

Uponor Ecoflex kummist otsakate Twin

- Kahele voolutorule
- Kaitseb toru otsa niiskuse ja mustuse eest
- Veetihe kuni 0,3 bar
- Komplektis EPDM kummist otsakate, roostevabast terasest klamber ja tihend

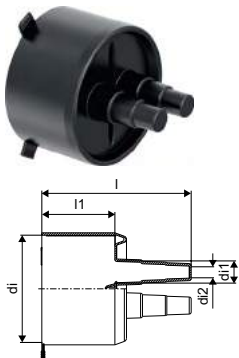

| Art. nr. | Dimension | l mm | l1 mm | di mm | di1 mm | di2 mm | no. tk | Weight kg | pakend | UOM |
|-----------------|-----------------------------|---------|----------|----------|-----------|-----------|-----------|--------------|--------|-----|
| 1034305* | 18-20+22-25+28/140+145 | 184 | 90 | 132 | 18 | 28 | 2 | 0,330 | 1 | tk |
| 1034306* | 18-22+25+28/25-28+32+40/175 | 184 | 90 | 166 | 18 | 40 | 2 | 0,440 | 1 | tk |
| 1018309 | 25+32+40/175 | 184 | 90 | 166 | 25 | 40 | 2 | 0,440 | 1 | tk |
| 1018308 | 25+32+50/175 | 184 | 90 | 166 | 25 | 50 | 2 | 0,450 | 1 | tk |
| 1018307 | 40+50+63/200 | 184 | 90 | 190 | 40 | 63 | 2 | 0,520 | 1 | tk |
| 1088979 | 75+90/250 | 194 | 90 | 235 | 67 | 84 | 2 | 0,800 | 1 | tk |

Uponor Ecoflex Quattro

- Neljale voolutorule
- Kaitseb toru otsa niiskuse ja mustuse eest
- Veetihe kuni 0,3 bar
- Komplektis EPDM kummist otsakate, roostevabast terasest klamber ja tihend

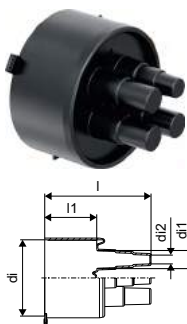

| Art. nr. | Dimension | l mm | l1 mm | di mm | di1 mm | di2 mm | no. tk | Weight kg | pakend | UOM |
|-----------------|-----------------|---------|----------|----------|-----------|-----------|-----------|--------------|--------|-----|
| 1086838* | 20+25+32/140 | 184 | 90 | 132 | 30 | 15 | 4 | 0,450 | 1 | tk |
| 1018306 | 18-32+25-32/175 | 184 | 90 | 166 | 30 | 15 | 4 | 0,490 | 1 | tk |
| 1034308 | 18-28+32+40/200 | 184 | 90 | 182 | 37,5 | 21,4 | 4 | 0,800 | 1 | tk |

Uponor Ecoflex kolmiku isol komplekt

- Kaitsekesta kolmiku pakett
- ABS isolatsioonikoorigud koos isolatsiooni ja üleminekutega
- Liikluskoormus kuni 60 tonni

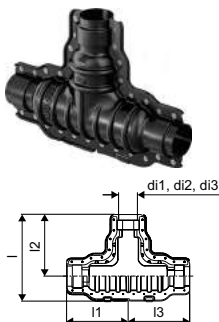

| Art. nr. | Dimension | l mm | l1 mm | l2 mm | l3 mm | di1 mm | di2 mm | di3 mm | Weight kg | 2. pak. | pakend | UOM |
|----------------|-----------------|---------|----------|----------|----------|-----------|-----------|-----------|--------------|---------|--------|-----|
| 1060986 | 140/90/68 | 666 | 470 | 470 | 470 | 140 | 90 | 68 | 9,770 | 5 | 1 | tk |
| 1060982 | 200/175/145/140 | 786 | 562 | 562 | 562 | 200 | 175 | 140 | 13,530 | 4 | 1 | tk |

Uponor Ecoflex

Uponor Ecoflex põlve isol. komplekt

- Kaitsekesta põlve pakett
- ABS isolatsioonikoorikud koos isolatsiooni ja üleminekutega
- Liikluskoormus kuni 60 tonni

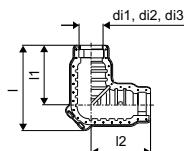

| Art. nr. | Dimension | l mm | l1 mm | l2 mm | di1 mm | di2 mm | di3 mm | Weight kg | 2. pak. | pakend | UOM |
|----------------|-----------------|---------|----------|----------|-----------|-----------|-----------|--------------|---------|--------|-----|
| 1060985 | 200/175/145/140 | 806 | 563 | 563 | 200 | 175 | 140 | 10,550 | 3 | 1 | tk |

Uponor Ecoflex jätku isol komplekt

- Kaitsekesta jätku pakett
- ABS isolatsioonikoorikud koos isolatsiooni ja üleminekutega
- Liikluskoormus kuni 60 tonni

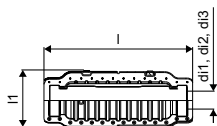

| Art. nr. | Dimension | l mm | l1 mm | di1 mm | di2 mm | di3 mm | Weight kg | 2. pak. | pakend | UOM |
|----------------|-----------------|---------|----------|-----------|-----------|-----------|--------------|---------|--------|-----|
| 1060984 | 200/175/145/140 | 1125 | 426 | 200 | 175 | 140 | 9,660 | 6 | 1 | tk |

Uponor Ecoflex kolmiku vahtkoorik

- PUR vaht isolatsioonielemendid, kahest poolest koosnev komplekt, kasutatav koormuseta alal

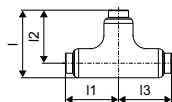

| Art. nr. | Dimension | l mm | l1 mm | l2 mm | l3 mm | Weight kg | pakend | UOM |
|----------------|-----------------|---------|----------|----------|----------|--------------|--------|-----|
| 1090042 | 200/175/145/140 | 450 | 353 | 353 | 353 | 1,080 | 1 | tk |

Uponor Ecoflex kaitsekesta ühenduskompl.

- Kaitsekesta jätku pakett
- Komplektis muhv ja kaks kuumahenevat hülssi
- Koormustaluvus 60 tonni

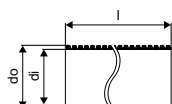

| Art. nr. | Dimension | l mm | di mm | do mm | s mm | Weight kg | 2. pak. | pakend | UOM |
|-----------------|-----------|---------|----------|----------|---------|--------------|---------|--------|-----|
| 1084574* | 175+200 | 650 | 218 | 250 | | 2,800 | 10 | 1 | tk |
| 1083872* | 250 | 720 | 275 | 315 | | 4,700 | 9 | 1 | tk |

Uponor Ecoflex

Uponor Ecoflex harukaev

- Ühenduskaev
- PE korpus, isolatsioon ja üleminekud
- Saadaval T ja X mudelid
- Liikluskoormus 500 kg, suuremate koormuste puhul kasutada spetsiaalseid betoonkonstruktsioone

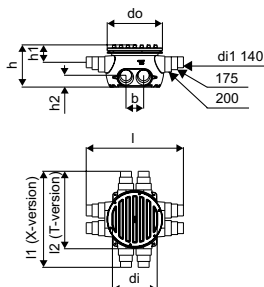

| Art. nr. | Dimension | l mm | I1 mm | I2 mm | di mm | do mm | b mm | h mm | h1 mm | h2 mm | no. tk | Weight kg | pakend UOM |
|-----------------|-------------------------|---------|----------|----------|----------|----------|---------|---------|----------|----------|-----------|--------------|------------|
| 1018326 | 6x140/145/175/200 | 1652 | | 1316 | 760 | 940 | 300 | 725 | 420 | 200 | 6 | 52,000 | 3 tk |
| 1018327* | 8x140/145/175/200 | 1652 | 1632 | | 760 | 940 | 300 | 725 | 420 | 200 | 8 | 53,000 | 3 tk |
| 1084576* | 2x250-6x140/145/175/200 | 1652 | 1486 | | 760 | 940 | 300 | 725 | 420 | 165 | 8 | 53,000 | 1 tk |
| 1084577* | 4x250-4x140/145/175/200 | 1652 | 1304 | | 760 | 940 | 300 | 725 | 420 | 165 | 8 | 53,000 | 1 tk |
| 1084578* | 6x250-2x140/145/175/200 | 1486 | 1304 | | 760 | 940 | 300 | 725 | 420 | 165 | 8 | 53,000 | 1 tk |

Uponor Ecoflex kuumahenev tihend

- Tihendab kaitsekaeva või mõne muu väljundiga

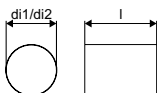

| Art. nr. | Dimension | l mm | di1 mm | di2 mm | Weight kg | 2. pak. | pakend UOM |
|----------------|-----------|---------|-----------|-----------|--------------|---------|------------|
| 1084575 | 250 | 300 | 330 | 165 | 0,720 | 15 | 1 tk |

Uponor Ecoflex kuumahenev kattetihend

- Paigalduspogna või kaevu ühenduse tihendamiseks, tõmblukuga
- Võimalik hilisem paigaldus

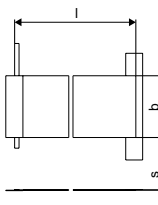

| Art. nr. | Dimension | l mm | s mm | b mm | Weight kg | 2. pak. | pakend UOM |
|----------------|-----------------|---------|---------|---------|--------------|---------|------------|
| 1034312 | 140/175/200/250 | 960 | 1,3 | 220 | 0,473 | 10 | 1 tk |

Uponor Ecoflex

Uponor Ecoflex ühenduspõlv Twin

- Eelisoleeritud PE-Xa toru põlv
- Kaks PE-Xa voolutoru
- Max. 6 bar / 95°C
- PUR vaht, PE kaitsekiht

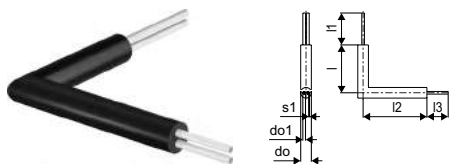

| Art. nr. | Dimension | l mm | l1 mm | l2 mm | l3 mm | do1 mm | do2 mm | s1 mm | Weight kg | pakend UOM | |
|----------------|--------------|------|-------|-------|-------|--------|--------|-------|-----------|------------|------|
| 1085105 | 2X63X5,8/205 | 900 | 600 | 1200 | 400 | 200 | 63 | 63 | 5,8 | 17,300 | 1 ea |
| 1088822 | 2x75x6.8/250 | 900 | 560 | 1200 | 375 | 250 | 75 | 75 | 6,8 | 22,400 | 1 ea |

Uponor Ecoflex läbiviigukomplekt NPW

- Valubeton või kivisein, läbiviigu tihendamiseks
- NWP = mitte survele vee isoleerimiseks
- Komplektis PE toru ja kuumahenev käis

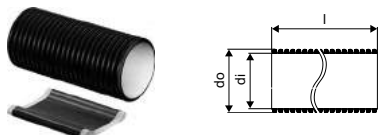

| Art. nr. | Dimension | l mm | di mm | do mm | Weight kg | 2. pak. | pakend UOM |
|-----------------|-----------|------|-------|-------|-----------|---------|------------|
| 1018267 | 68+90 | 550 | 95 | 110 | 1,00 | | 1 tk |
| 1018269 | 140+145 | 550 | 175 | 200 | 1,300 | | 1 ea |
| 1018268 | 175+200 | 550 | 218 | 250 | 1,900 | | 1 tk |
| 1083871* | 250 | 550 | 275 | 315 | 2,9 | 16 | 1 tk |

Uponor Ecoflex läbiviigutihend

- Betoon või kiviseintele
- Vältib niiskuse tungimist hoonesse
- Radooni tõkestamine testitud. Läbiviigutihend koos pingutusvõõga

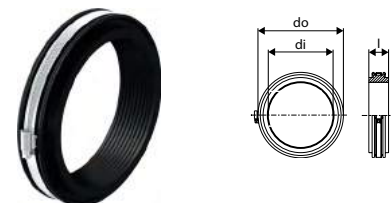

| Art. nr. | Dimension | l mm | di mm | do mm | Weight kg | 2. pak. | pakend UOM |
|----------------|-----------|------|-------|-------|-----------|---------|------------|
| 1034202 | 140+145 | 40 | 140 | 190 | 0,349 | 40 | 1 tk |
| 1034203 | 175 | 40 | 175 | 225 | 0,435 | 30 | 1 tk |
| 1034204 | 200 | 50 | 200 | 250 | 0,616 | 20 | 1 tk |
| 1090415 | 250 | 50 | 250 | 300 | 0,785 | | 1 tk |

Uponor Ecoflex paigalduspöogen

- Kasutatakse Ecoflex toru sisenemisel hoonesse läbi valatud põrand



| Art. nr. | Dimension | d mm | r mm | Weight kg | pakend UOM |
|----------------|-----------|---------|------|-----------|------------|
| 1030269 | 175/140 | 140-175 | 1200 | 12,000 | 9 tk |
| 1030270 | 200 | 200 | 1000 | 17,000 | 9 tk |

Uponor Ecoflex läbiviigukomplekt NPW

- Valubeton või kiviseinale
- NWP = mitte survele vee isoleerimiseks
- Komplektis PE toru ja kuumahenev käis

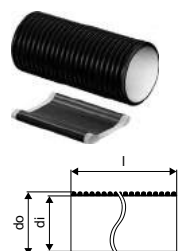

| Art. nr. | Dimension | l mm | di mm | do mm | Weight kg | pakend UOM |
|----------------|-----------|------|-------|-------|-----------|------------|
| 1018267 | 68+90 | 550 | 95 | 110 | 1,000 | 1 tk |

Uponor Ecoflex

Uponor Ecoflex paranduskäis

- Kuumahenev lint kaitsekesta kahjustuste kõrvaldamiseks

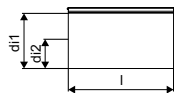

| Art. nr. | Dimension | l mm | di1 mm | di2 mm | s mm | Weight kg | pakend | UOM |
|----------------|-----------------------|---------|-----------|-----------|---------|--------------|--------|-----|
| 1036014 | 140+145+175+200-700mm | 700 | 226 | 98 | 1,7 | 1,200 | 1 | tk |

Uponor Ecoflex hoiatuslint punane

- Paigaldatud Ecoflex torude asukoha markeerimiseks
- Lindi markeering vastavalt nõuetele

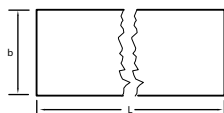

| Art. nr. | Dimension | L m | b mm | Weight kg | pakend | UOM |
|----------------|-------------|--------|---------|--------------|--------|-----|
| 1018385 | 40mm x 250m | 250 | 40 | 2,000 | 1 | tk |

Uponor ventilatsiooni torustikud

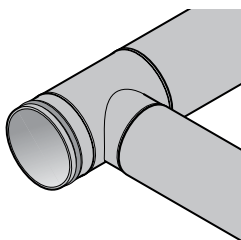

Uponor ventilatsioonisüsteem on hügieeniline ja lõhnatu lahendus korteripõhise või eramu ventilatsiooni ehitamiseks. Patenteeritud ühendussüsteem lihtsustab paigaldust.

Eelised

- Lihtne ja kiire paigaldus
- Püsivalt antistaatiline
- Väikesed energiakaod
- Ei vaja eri tööriistu
- Täielik valik liitmikke



Kirjeldus

- Tooraine lõhnatu ja mittetoksiline polüpropüleen
- Antistaatiline
- Värvus must

Kasutusala

- Ventilatsiooni torud ja liitmikud

Sertifitseerimine

- VTT sertifikaadid nr. 158/01 ja VTT-C-6220-10

Uponor Ventilation toru

- Kaitsekorkidega torud
- Sisepind püsivalt antistaatiline
- Patenteeritud välispind antistaatiline 2 aastat peale tootmist, et vältida torude määrdumist ladustamisel ja paigaldamisel

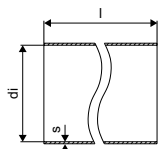

| Art. nr. | Dimension | l mm | di mm | s mm | pakend | UOM |
|----------|-----------|---------|----------|---------|--------|-----|
| 1068037 | 100mm 3m | 3000 | 100 | 2,0 | 50 | tk |
| 1068038 | 125mm 3m | 3000 | 125 | 2,0 | 32 | tk |
| 1068039 | 160mm 3m | 3000 | 160 | 3,0 | 18 | tk |
| 1068040 | 200mm 3m | 3000 | 200 | 3,0 | 20 | tk |

Uponor Ventilation põlv

- Patenteeritud ühendusmeetod, tihedusklass D
- Pakitud individuaalsesse hügieenilisse pakendisse
- Püsivalt antistaatiline

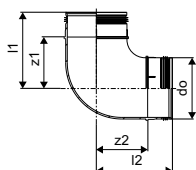

| Art. nr. | Dimension | l1 mm | l2 mm | do mm | z1 mm | z2 mm | α | 2. pak. | pakend | UOM |
|----------|-----------|----------|----------|----------|----------|----------|-----|---------|--------|-----|
| 1068053 | 100X90° | 124 | 124 | 100 | 84 | 84 | 90° | 10 | 1 | tk |
| 1068054 | 125X90° | 163 | 163 | 125 | 113 | 113 | 90° | 10 | 1 | tk |
| 1068055 | 160X90° | 213 | 213 | 160 | 163 | 163 | 90° | 6 | 1 | tk |
| 1068052 | 200X90° | 180 | 180 | 199 | 130 | 130 | 90° | 4 | 1 | tk |

Uponor ventilatsiooni torustikud

Uponor Ventilation põlv

- Patenteeritud ühendusmeetod, tihedusklass D
- Pakitud individuaalsesse hügieenilisse pakendisse
- Püsivalt antistaatiline

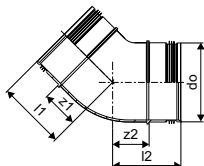

| Art. nr. | Dimension | l1 mm | l2 mm | do mm | z1 mm | z2 mm | α | 2. pak. | pakend | UOM |
|----------------|-----------|----------|----------|----------|----------|----------|----------|---------|--------|-----|
| 1068057 | 100X45° | 86 | 86 | 100 | 46 | 46 | 45° | 11 | 1 | tk |
| 1068058 | 125X45° | 86 | 86 | 125 | 36 | 36 | 45° | 14 | 1 | tk |
| 1068059 | 160X45° | 95 | 95 | 160 | 45 | 45 | 45° | 12 | 1 | tk |
| 1068056 | 200X45° | 103 | 103 | 199 | 53 | 53 | 45° | 8 | 1 | tk |

Uponor Ventilation kolmik

- Patenteeritud ühendusmeetod, tihedusklass D
- Pakitud individuaalsesse hügieenilisse pakendisse
- Püsivalt antistaatiline

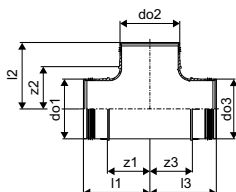

| Art. nr. | Dimension | l1 mm | l2 mm | l3 mm | do1 mm | do2 mm | do3 mm | z1 mm | z2 mm | z3 mm | 2. pak. | pakend | UOM |
|----------------|-------------|----------|----------|----------|-----------|-----------|-----------|----------|----------|----------|---------|--------|-----|
| 1068060 | 100/100X90° | 111 | 111 | 111 | 99 | 99 | 100 | 71 | 71 | 71 | 15 | 1 | tk |
| 1068064 | 125/100X90° | 122 | 124 | 122 | 124 | 99 | 125 | 72 | 74 | 72 | 15 | 1 | tk |
| 1068061 | 125/125X90° | 134 | 134 | 134 | 124 | 124 | 125 | 84 | 84 | 84 | 10 | 1 | tk |
| 1068065 | 160/100X90° | 122 | 141 | 122 | 159 | 99 | 159 | 72 | 91 | 72 | 10 | 1 | tk |
| 1068062 | 160/125X90° | 134 | 151 | 134 | 160 | 125 | 160 | 84 | 101 | 84 | 7 | 1 | tk |
| 1068063 | 160/160X90° | 151 | 151 | 151 | 159 | 159 | 159 | 101 | 101 | 101 | 6 | 1 | tk |
| 1068066 | 200/160X90° | 151 | 171 | 151 | 199 | 159 | 199 | 101 | 121 | 101 | 5 | 1 | tk |

Uponor Ventilation jätk

- Patenteeritud ühendusmeetod, tihedusklass D
- Pakitud individuaalsesse hügieenilisse pakendisse
- Püsivalt antistaatiline

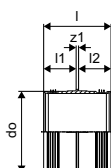

| Art. nr. | Dimension | l mm | l1 mm | l2 mm | do mm | z1 mm | 2. pak. | pakend | UOM |
|----------------|-----------|---------|----------|----------|----------|----------|---------|--------|-----|
| 1068049 | 100mm | 83 | 40 | 40 | 100 | 3 | 20 | 1 | tk |
| 1068050 | 125mm | 103 | 50 | 50 | 125 | 3 | 30 | 1 | tk |
| 1068051 | 160mm | 103 | 50 | 50 | 160 | 3 | 15 | 1 | tk |
| 1068048 | 200mm | 103 | 50 | 50 | 200 | 3 | 12 | 1 | tk |

Uponor ventilatsiooni torustikud

Uponor Ventilation kork

- Patenteeritud ühendusmeetod, tihedusklass D
- Pakitud individuaalsesse hügieenilisse pakendisse
- Püsivalt antistaatiline

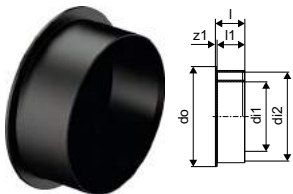

| Art. nr. | Dimension | l mm | l1 mm | d1 mm | d2 mm | do mm | s mm | z1 mm | 2. pak. | pakend | UOM |
|----------------|-----------|---------|----------|----------|----------|----------|---------|----------|---------|--------|-----|
| 1068067 | 100mm | 43 | 40 | 100 | | 120 | 2,2 | 3 | 20 | 1 | tk |
| 1068068 | 125mm | 33 | 30 | 125 | | 145 | 2,2 | 3 | 40 | 1 | tk |
| 1068069 | 160/125mm | 53 | 50 | 125 | 160 | 180 | 2,8 | 3 | 30 | 1 | tk |

Uponor Ventilation siirdmik

- Patenteeritud ühendusmeetod, tihedusklass D
- Pakitud individuaalsesse hügieenilisse pakendisse
- Püsivalt antistaatiline

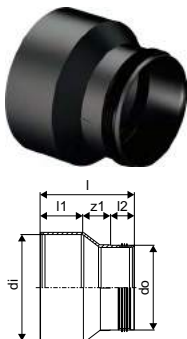

| Art. nr. | Dimension | l mm | l1 mm | l2 mm | d1 mm | d2 mm | z1 mm | z2 mm | 2. pak. | pakend | UOM |
|----------------|-----------|---------|----------|----------|----------|----------|----------|----------|---------|--------|-----|
| 1068070 | 125-100mm | 111 | 50 | 30 | 125 | 100 | 33 | | 12 | 1 | tk |
| 1068071 | 160-125mm | 131 | 50 | 33 | 160 | 125 | 48 | | 15 | 1 | tk |
| 1068072 | 200-160mm | 141 | 50 | 33 | 200 | 160 | 59 | | 12 | 1 | tk |

Uponor Ventilation Flex põlv

- Gofreeritud keskosaga torulõik
- Võimaldab paindenurki 0-45 ja 0-90 kraadi

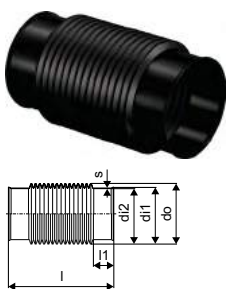

| Art. nr. | Dimension | l mm | l1 mm | d1 mm | d2 mm | do mm | s mm | 2. pak. | pakend | UOM |
|----------------|-----------|---------|----------|----------|----------|----------|---------|---------|--------|-----|
| 1061401 | 125 0-45 | 262 | 52 | 131 | 125 | 150 | 1,5 | 12 | 1 | tk |
| 1061402 | 125 0-90 | 419 | 52 | 131 | 125 | 150 | 1,5 | 8 | 1 | tk |
| 1061403 | 160 0-45 | 334 | 52 | 166 | 160 | 197,2 | 2,0 | 6 | 1 | tk |
| 1061404 | 160 0-90 | 563 | 52 | 166 | 160 | 197,2 | 2,0 | 4 | 1 | tk |

Uponor isoleeritud ventilatsiooni torustikud

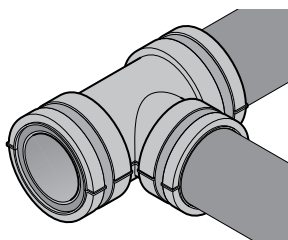

Uponor ventilatsioonisüsteem on hügieeniline ja lõhnatu lahendus korteripõhise või eramu ventilatsiooni ehitamiseks. Isolatsioon väldib kondensaadi tekkimise välispinnale. Patenteeritud ühendussüsteem lihtsustab

paigaldust.

Eelised

- Lihtne ja kiire paigaldus
- Püsivalt antistaatiline
- Väikesed energiakaod
- Ei vaja eri tööriistu
- Täielik valik liitmikke



Kirjeldus

- Tooraine lõhnatu ja mittetoksiline polüpropüleen
- Antistaatiline materjal
- Torude ja liitmike värvus must, isolatsioon hall
- Isolatsioon vahtpolüetüleen
- Isolatsiooni paksus 15mm

Kasutusala

- Kondensatsiooni kaitse isolatsiooniga kaetud ventilatsiooni torud ja liitmikud

Sertifitseerimine

- VTT sertifikaadid nr. 158/01 ja VTT-C-6220-10

Uponor Ventilation toru isoleeritud

- Kaitsekorkidega torud
- Sisepind püsivalt antistaatiline
- Patenteeritud välispind antistaatiline 2 aastat peale tootmist, et vältida torude määrdumist ladustamisel ja paigaldamisel

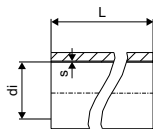

| Art. nr. | Dimension | l mm | di mm | s mm | pakend | UOM |
|----------------|-----------|---------|----------|---------|--------|-----|
| 1068041 | 100mm 3m | 3000 | 100 | 17,1 | 40 | tk |
| 1068042 | 125mm 3m | 3000 | 125 | 17,1 | 28 | tk |
| 1068043 | 160mm 3m | 3000 | 160 | 17,5 | 20 | tk |
| 1068044 | 200mm 3m | 3000 | 200 | 18,0 | 20 | tk |

Uponor isoleeritud ventilatsiooni torustikud

Uponor Ventilation põlv isoleeritud

- Patenteeritud ühendusmeetod, tihedusklass D
- Pakitud individuaalsesse hügieenilisse pakendisse
- Püsivalt antistaatiline
- Iga liitmik varustatud vajaliku arvu pingutitega

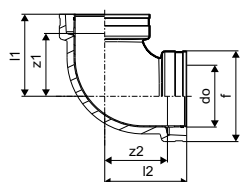

| Art. nr. | Dimension | l1 mm | l2 mm | do mm | z1 mm | z2 mm | f mm | α | 2. pak. | pakend | UOM |
|----------------|-----------|----------|----------|----------|----------|----------|---------|----------|---------|--------|-----|
| 1068078 | 100 X 90° | 124 | 124 | 100 | 84 | 84 | 170 | 90° | 10 | 1 | tk |
| 1068079 | 125 X 90° | 163 | 163 | 125 | 113 | 113 | 195 | 90° | 7 | 1 | tk |
| 1068080 | 160 X 90° | 213 | 213 | 160 | 163 | 163 | 230 | 90° | 8 | 1 | tk |
| 1068077 | 200 X 90° | 180 | 180 | 199 | 130 | 130 | 270 | 90° | 6 | 1 | tk |

Uponor Ventilation põlv isoleeritud

- Patenteeritud ühendusmeetod, tihedusklass D
- Pakitud individuaalsesse hügieenilisse pakendisse
- Püsivalt antistaatiline
- Iga liitmik varustatud vajaliku arvu pingutitega

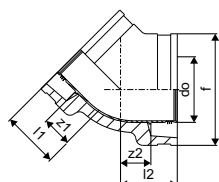

| Art. nr. | Dimension | l1 mm | l2 mm | do mm | z1 mm | z2 mm | f mm | α | 2. pak. | pakend | UOM |
|----------------|-----------|----------|----------|----------|----------|----------|---------|----------|---------|--------|-----|
| 1068082 | 100 X 45° | 86 | 86 | 100 | 46 | 46 | 169 | 45° | 10 | 1 | tk |
| 1068083 | 125 X 45° | 86 | 86 | 125 | 36 | 36 | 195 | 45° | 6 | 1 | tk |
| 1068084 | 160 X 45° | 95 | 95 | 160 | 45 | 45 | 230 | 45° | 6 | 1 | tk |
| 1068081 | 200 X 45° | 103 | 103 | 199 | 53 | 53 | 269 | 45° | 10 | 1 | tk |

Uponor Ventilation kolmik isoleeritud

- Patenteeritud ühendusmeetod, tihedusklass D
- Pakitud individuaalsesse hügieenilisse pakendisse
- Püsivalt antistaatiline
- Iga liitmik varustatud vajaliku arvu pingutitega

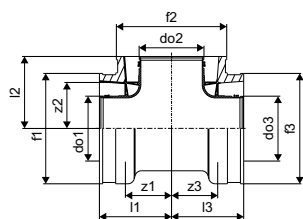

| Art. nr. | Dimension | l1 mm | l2 mm | l3 mm | do1 mm | do2 mm | do3 mm | z1 mm | z2 mm | z3 mm | f mm | g mm | 2. pak. | pakend | UOM |
|----------------|-------------|----------|----------|----------|-----------|-----------|-----------|----------|----------|----------|---------|---------|---------|--------|-----|
| 1068085 | 100/100X90° | 111 | 111 | 111 | 99 | 99 | 100 | 71 | 71 | 71 | 170 | 8 | 1 | tk | |
| 1068086 | 125/125X90° | 122 | 124 | 122 | 124 | 99 | 125 | 72 | 74 | 72 | 195 | 10 | 1 | tk | |
| 1068087 | 160/125X90° | 134 | 134 | 134 | 124 | 124 | 125 | 84 | 84 | 84 | 230 | 195 | 10 | 1 | tk |
| 1068088 | 160/160X90° | 122 | 141 | 122 | 159 | 99 | 159 | 72 | 91 | 72 | 230 | 10 | 1 | tk | |
| 1068089 | 125/100X90° | 134 | 151 | 134 | 160 | 125 | 160 | 84 | 101 | 84 | 195 | 170 | 8 | 1 | tk |
| 1068090 | 160/100X90° | 151 | 151 | 151 | 159 | 159 | 159 | 101 | 101 | 101 | 230 | 170 | 10 | 1 | tk |
| 1068091 | 200/160X90° | 151 | 171 | 151 | 199 | 159 | 199 | 101 | 121 | 101 | 270 | 230 | 5 | 1 | tk |

Uponor isoleeritud ventilatsiooni torustikud

Uponor Ventilation jätk isoleeritud

- Patenteeritud ühendusmeetod, tihedusklass D
- Pakitud individuaalsesse hügieenilisse pakendisse
- Püsivalt antistaatiline
- Iga liitmik varustatud vajaliku arvu pingutitega

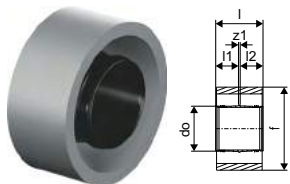

| Art. nr. | Dimension | l mm | l1 mm | l2 mm | do mm | z1 mm | 2. pak. | pakend | UOM |
|----------------|-----------|---------|----------|----------|----------|----------|---------|--------|-----|
| 1068074 | 100mm | 83 | 40 | 40 | 100 | 3 | 9 | 1 | tk |
| 1068075 | 125mm | 103 | 50 | 50 | 125 | 3 | 10 | 1 | tk |
| 1068076 | 160mm | 103 | 50 | 50 | 160 | 3 | 9 | 1 | tk |
| 1068073 | 200mm | 103 | 50 | 50 | 200 | 3 | 10 | 1 | tk |

Uponor Ventilation kork isoleeritud

- Patenteeritud ühendusmeetod, tihedusklass D
- Pakitud individuaalsesse hügieenilisse pakendisse
- Püsivalt antistaatiline
- Iga liitmik varustatud vajaliku arvu pingutitega

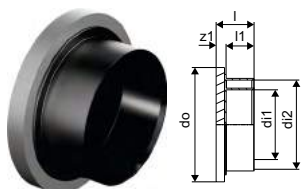

| Art. nr. | Dimension | l mm | l1 mm | di1 mm | di2 mm | do mm | do1 mm | do2 mm | s mm | s2 mm | z1 mm | 2. pak. | pakend | UOM |
|----------------|-----------|---------|----------|-----------|-----------|----------|-----------|-----------|---------|----------|----------|---------|--------|-----|
| 1068092 | 100mm | 58 | 40 | 100 | | 140 | 25 | 48 | 2,0 | 10,0 | 18 | 10 | 1 | tk |
| 1068093 | 125mm | 48 | 30 | 125 | | 165 | | | 2,0 | | 18 | 6 | 1 | tk |
| 1068094 | 160/125mm | 68 | 50 | 125 | 160 | 205 | | | 2,0 | | 18 | 10 | 1 | tk |

Uponor Ventilation siirdmik isoleeritud

- Patenteeritud ühendusmeetod, tihedusklass D
- Pakitud individuaalsesse hügieenilisse pakendisse
- Püsivalt antistaatiline
- Iga liitmik varustatud vajaliku arvu pingutitega

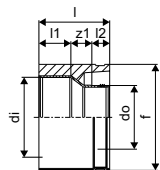

| Art. nr. | Dimension | l mm | l1 mm | l2 mm | di mm | do mm | z1 mm | f mm | 2. pak. | pakend | UOM |
|----------------|-----------|---------|----------|----------|----------|----------|----------|---------|---------|--------|-----|
| 1068095 | 125-100mm | 111 | 48 | 30 | 125 | 100 | 33 | 160 | 10 | 1 | tk |
| 1068096 | 160-125mm | 131 | 50 | 33 | 160 | 125 | 48 | 206 | 8 | 1 | tk |
| 1068097 | 200-160mm | 141 | 49 | 33 | 200 | 160 | 59 | 246 | 8 | 1 | tk |

Uponor Combi Port

Uponor Combi Port

Kirjeldus

- Täielikult eelkoostatud ja survetestitud sõlm
- Tehnilised piirangud tootelehtedel
- Plastist toru kinnitusklambriid müra summutamiseks ja soojuskadude vähendamiseks
- DVGW sertifitseeritud PM klapp
- Vahetükk soojusmõõtjale
- Potentsiaali ühtlustamise ühenduse võimalus (markeeritud)
- max. kütte töö rõhk: PN10
- max. tarbevee töö rõhk: PN10
- max. töötemperatuur: 85 °C
- max. kütte rõhkude vahe: 2,5 bar
- min. tarbevee rõhk: 2,0 bar
- Tarbevee liitmike materjal: CW617N
- Kütte liitmike materjal: CW617N, CW614N
- Toru materjal: roostevaba teras 1.4401

Uponor Combi Port B 1000 B 1000 UFH/RC

- Külma vee sisendil vahetükk veemõõtja paigaldamiseks
- Termostaatiline möödaviik klapp
- Primaarpoole diferentsiaalrõhu juhtimine
- Põrandkütte segamissõlm, 3-punkti ajam, komplektis ohutustemperatuuri piiraja
- Teine, segamiseta kütteväljund
- Tühjenduskomplekt
- Sooja tarbevee temperatuuri piiraja
- Soojusmõõtja
- Külma vee mõõtja
- Smatrix Move
- Smatrix Wave
- Smart S kollektor 5 kontuurile koos ajamitega
- Joodetud vasest plaatsoojusvaheti
- Õhueraldi
- Külma vee filter 0,5 mm
- Primaarpoole kütte pealevoolu filter HZ-VL-PR 0,5 mm
- Sekundaarpoole kütte tsooni ventiil: Kvs 0,06-0,9
- Mõõtmed: L/K/S 610 x 1.200 x 150 mm



| Art. nr. | Dimension | b mm | h mm | d mm | Weight kg | pakend | UOM |
|-----------------|-------------|---------|---------|---------|--------------|--------|-----|
| 1089500* | 19 l/min 5L | 610 | 1200 | 150 | 32,000 | 1 | tk |

Uponor Combi Port

Uponor Combi Port B 1000 B 1000 H/C

- Külma vee sisend vahetükiga veemõõtja paigaldamiseks
- Termostaatiline möödaviikklapp
- Primaarpoole diferentsiaalrõhu juhtimine
- Põrandkütte segamissõlm, 3-punkti ajam, komplektis ohutustemperatuuri piiraja
- Sooja tarbevee temperatuuri piiraja
- Soojusmõõtja
- Külma vee mõõtja
- Tühjenduskomplekt
- Jahutusmoodul koos diferentsiaalrõhu juhtimisega
- Jahutusenergia mõõtja
- Smatrix Wave
- Smatrix Move PLUS
- Vario M kollektor 8 kontuurile koos ajamitega
- Seinapealne kapp koos raami ja uksega RAL 9016
- Joodetud vasest plaatsoojusvaheti
- Tehnilised piirangud tootelehel
- Õhu eraldaja
- Külma vee filter 0,5 mm
- Kütte primaarpoole pealevoolu filter HZ-VL-PR 0,5 mm
- Sekundaarpoole küttekontuuri tsooni ventiil: Kvs 0,06-0,9;
- Mõõtmed: L/K/S 810 x 1.200 x 150 mm



| Art. nr. | Dimension | b mm | h mm | d mm | Weight kg | pakend | UOM |
|-----------------|-------------|---------|---------|---------|--------------|--------|-----|
| 1089499* | 19 l/min 8L | 810 | 1200 | 150 | 30,000 | 1 | tk |

Uponor Combi Port B 1000 B 1000 HY UFH

- Külma vee sisend vahetükiga veemõõtja paigaldamiseks
- Termostaatiline möödaviikklapp
- Sekundaarpoole diferentsiaalrõhu juhtimine
- Tühjenduskomplekt
- Vahetükk soojusmõõtjale
- Joodetud vasest plaatsoojusvaheti
- Õhueraldaja
- Külma vee filter 0,5 mm
- Kütte primaarpoole pealevoolu filter HZ-VL-PR 0,5 mm
- Sekundaarpoole küttekontuuri tsooniventil: Kvs 0,06-0,9;
- max. töötemperatuur: 60 °C
- max. kütte rõhkude vahe: 2,5 bar
- min. tarbevee rõhk: 3 bar
- Mõõtmed: L/K/S 556 x 620 x 145 mm



| Art. nr. | Dimension | b mm | h mm | d mm | Weight kg | pakend | UOM |
|----------------|---------------|---------|---------|---------|--------------|--------|-----|
| 1089501 | 15 l/min 13kW | 556 | 620 | 145 | 23,000 | 1 | tk |
| 1089502 | 17 l/min 21kW | 556 | 620 | 145 | 23,000 | 1 | tk |

Uponor Combi Port

Uponor Combi Port T 1000 T 1000 RC

- Termostaatiline möödaviiguventiil
- Primaarpoole diferentsiaalrõhu juhtimine
- Tühjenduskomplekt
- Vahetükk soojusmõõtjale
- Joodetud vasest plaatsoojusvaheti
- Õhueraldaja
- Külma vee filter 0,5 mm
- Kütte primaarpoole pealevoolu filter HZ-VL-PR 0,5 mm
- Sekundaarpoole küttekontuuri tsooniventiiil: Kvs 0,06-0,9;
- Mõõtmed: L/K/S 436 x 690 x 125 mm



| Art. nr. | Dimension | b mm | h mm | d mm | Weight kg | pakend | UOM |
|----------------|-----------|---------|---------|---------|--------------|--------|-----|
| 1089503 | 15 l/min | 436 | 690 | 125 | 15,700 | 1 | tk |

Uponor Combi Port PRO RC



| Art. nr. | Dimension | l mm | l1 mm | b mm | h mm | h1 mm | w mm | w1 mm | 2. pak. | pakend | UOM |
|----------------|------------|---------|----------|---------|---------|----------|---------|----------|---------|--------|-----|
| 1093769 | 15l/min | 556 | 83 | 65 | 108 | 65 | 618 | 600 | 16 | 1 | tk |
| 1093777 | VA 15l/min | 556 | 83 | 65 | 108 | 65 | 618 | 600 | 16 | 1 | tk |
| 1093773 | 19l/min | 556 | 83 | 65 | 108 | 65 | 618 | 600 | 16 | 1 | tk |
| 1093781 | VA 19l/min | 556 | 83 | 65 | 108 | 65 | 618 | 600 | 16 | 1 | tk |

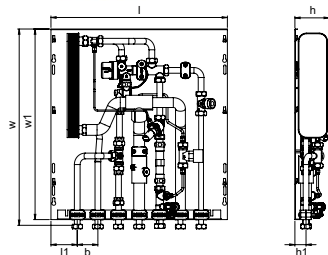

Uponor Combi Port PRO RC TWB



| Art. nr. | Dimension | l mm | l1 mm | b mm | h mm | h1 mm | w mm | w1 mm | 2. pak. | pakend | UOM |
|----------------|------------|---------|----------|---------|---------|----------|---------|----------|---------|--------|-----|
| 1093770 | 15l/min | 556 | 83 | 65 | 108 | 35 | 618 | 600 | 16 | 1 | tk |
| 1093778 | VA 15l/min | 556 | 83 | 65 | 108 | 35 | 618 | 600 | 16 | 1 | tk |
| 1093774 | 19l/min | 556 | 83 | 65 | 108 | 35 | 618 | 600 | 16 | 1 | tk |
| 1093782 | VA 19l/min | 556 | 83 | 65 | 108 | 35 | 618 | 600 | 16 | 1 | tk |

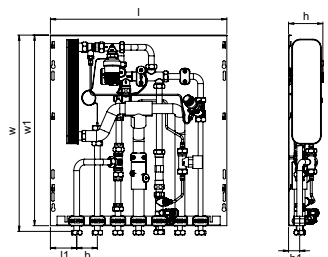

Uponor Combi Port

Uponor Combi Port PRO RC RTB



NEW
NEW
NEW
NEW

| Art. nr. | Dimension | l mm | l1 mm | b mm | h mm | h1 mm | w mm | w1 mm | 2. pak. | pakend | UOM |
|----------|------------|---------|----------|---------|---------|----------|---------|----------|---------|--------|-----|
| 1093771 | 15l/min | 556 | 83 | 65 | 108 | 35 | 618 | 600 | 16 | 1 | tk |
| 1093779 | VA 15l/min | 556 | 83 | 65 | 108 | 35 | 618 | 600 | 16 | 1 | tk |
| 1093775 | 19l/min | 556 | 83 | 65 | 108 | 35 | 618 | 600 | 16 | 1 | tk |
| 1093783 | VA 19l/min | 556 | 83 | 65 | 108 | 35 | 618 | 600 | 16 | 1 | tk |

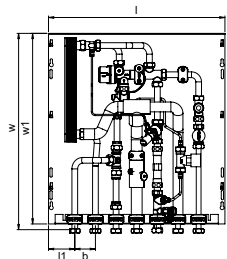

Uponor Combi Port PRO RC TWB RTB



NEW
NEW
NEW
NEW

| Art. nr. | Dimension | l mm | l1 mm | b mm | h mm | h1 mm | w mm | w1 mm | 2. pak. | pakend | UOM |
|----------|------------|---------|----------|---------|---------|----------|---------|----------|---------|--------|-----|
| 1093772 | 15l/min | 556 | 83 | 65 | 108 | 35 | 618 | 600 | 16 | 1 | tk |
| 1093780 | VA 15l/min | 556 | 83 | 65 | 108 | 35 | 618 | 600 | 16 | 1 | tk |
| 1093776 | 19l/min | 556 | 83 | 65 | 108 | 35 | 618 | 600 | 16 | 1 | tk |
| 1093784 | VA 19l/min | 556 | 83 | 65 | 108 | 35 | 618 | 600 | 16 | 1 | tk |

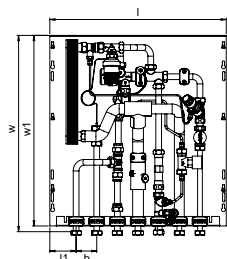

Uponor Combi Port PRO UFH



NEW
NEW
NEW
NEW

| Art. nr. | Dimension | l mm | l1 mm | b mm | h mm | h1 mm | w mm | w1 mm | 2. pak. | pakend | UOM |
|----------|------------|---------|----------|---------|---------|----------|---------|----------|---------|--------|-----|
| 1093785 | 15l/min | 556 | 83 | 65 | 107 | 35 | 618 | 600 | 16 | 1 | tk |
| 1093793 | VA 15l/min | 556 | 83 | 65 | 107 | 35 | 618 | 600 | 16 | 1 | tk |
| 1093789 | 19l/min | 556 | 83 | 65 | 107 | 35 | 618 | 600 | 16 | 1 | tk |
| 1093797 | VA 19l/min | 556 | 83 | 65 | 107 | 35 | 618 | 600 | 16 | 1 | tk |

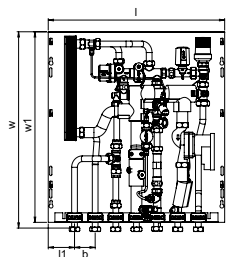

Uponor Combi Port

Uponor Combi Port PRO UFH TWB



NEW
NEW
NEW
NEW

| Art. nr. | Dimension | l mm | l1 mm | b mm | h mm | h1 mm | w mm | w1 mm | 2. pak. | pakend | UOM |
|----------------|------------|---------|----------|---------|---------|----------|---------|----------|---------|--------|-----|
| 1093787 | 15l/min | 556 | 83 | 65 | 107 | 35 | 618 | 600 | 16 | 1 | tk |
| 1093795 | VA 15l/min | 556 | 83 | 65 | 107 | 35 | 618 | 600 | 16 | 1 | tk |
| 1093791 | 19l/min | 556 | 83 | 65 | 107 | 35 | 618 | 600 | 16 | 1 | tk |
| 1093799 | VA 19l/min | 556 | 83 | 65 | 107 | 35 | 618 | 600 | 16 | 1 | tk |

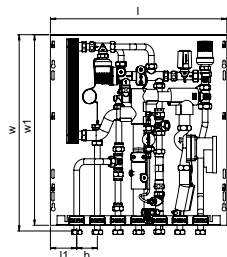

Uponor Combi Port PRO UFH 2.HC



NEW
NEW
NEW
NEW

| Art. nr. | Dimension | l mm | l1 mm | b mm | b1 mm | h mm | h1 mm | w mm | w1 mm | 2. pak. | pakend | UOM |
|----------------|------------|---------|----------|---------|----------|---------|----------|---------|----------|---------|--------|-----|
| 1093786 | 15l/min | 556 | 33 | 65 | 50 | 107 | 35 | 618 | 600 | 16 | 1 | tk |
| 1093794 | VA 15l/min | 556 | 33 | 65 | 50 | 107 | 35 | 618 | 600 | 16 | 1 | tk |
| 1093790 | 19l/min | 556 | 33 | 65 | 50 | 107 | 35 | 618 | 600 | 16 | 1 | tk |
| 1093798 | VA 19l/min | 556 | 33 | 65 | 50 | 107 | 35 | 618 | 600 | 16 | 1 | tk |

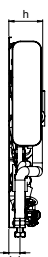
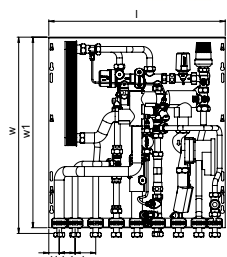

Uponor Combi Port PRO UFH 2.HC TWB



NEW
NEW
NEW
NEW

| Art. nr. | Dimension | l mm | l1 mm | b mm | b1 mm | h mm | h1 mm | w mm | w1 mm | 2. pak. | pakend | UOM |
|----------------|------------|---------|----------|---------|----------|---------|----------|---------|----------|---------|--------|-----|
| 1093788 | 15l/min | 556 | 33 | 65 | 50 | 107 | 35 | 618 | 600 | 16 | 1 | tk |
| 1093796 | VA 15l/min | 556 | 33 | 65 | 50 | 107 | 35 | 618 | 600 | 16 | 1 | tk |
| 1093792 | 19l/min | 556 | 33 | 65 | 50 | 107 | 35 | 618 | 600 | 16 | 1 | tk |
| 1093800 | VA 19l/min | 556 | 33 | 65 | 50 | 107 | 35 | 618 | 600 | 16 | 1 | tk |

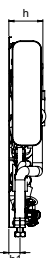
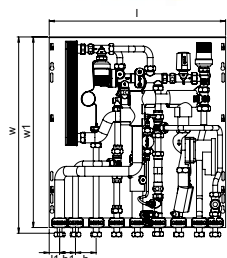

Uponor Combi Port

Uponor Combi Port Base



| Art. nr. | Dimension | l mm | l1 mm | b mm | h mm | h1 mm | w mm | w1 mm | 2. pak. | pakend | UOM |
|----------------|------------|---------|----------|---------|---------|----------|---------|----------|---------|--------|-----|
| 1093801 | 15l/min | 556 | 83 | 65 | 107 | 35 | 618 | 600 | 16 | 1 | tk |
| 1093803 | VA 15l/min | 556 | 83 | 65 | 107 | 35 | 618 | 600 | 16 | 1 | tk |
| 1093805 | 19l/min | 556 | 83 | 65 | 107 | 35 | 618 | 600 | 16 | 1 | tk |
| 1093807 | VA 19l/min | 556 | 83 | 65 | 107 | 35 | 618 | 600 | 16 | 1 | tk |

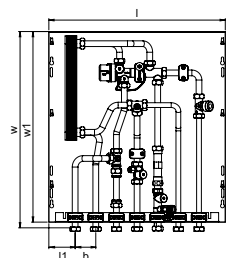

Uponor Combi Port Base TWB



| Art. nr. | Dimension | l mm | l1 mm | b mm | h mm | h1 mm | w mm | w1 mm | 2. pak. | pakend | UOM |
|----------------|------------|---------|----------|---------|---------|----------|---------|----------|---------|--------|-----|
| 1093802 | 15l/min | 556 | 83 | 65 | 107 | 35 | 618 | 600 | 16 | 1 | tk |
| 1093804 | VA 15l/min | 556 | 83 | 65 | 107 | 35 | 618 | 600 | 16 | 1 | tk |
| 1093806 | 19l/min | 556 | 83 | 65 | 107 | 35 | 618 | 600 | 16 | 1 | tk |
| 1093808 | VA 19l/min | 556 | 83 | 65 | 107 | 35 | 618 | 600 | 16 | 1 | tk |

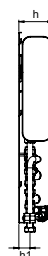
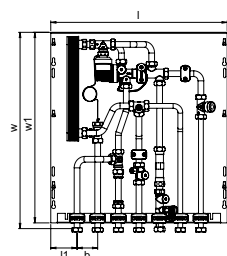

Uponor Aqua Port

Uponor Aqua Port

Kirjeldus

- Täielikult eelkoostatud ja survetestitud sõlm
- Tehnilised piirangud tootelehtedel
- Plastist toru kinnitusklambriid müra summutamiseks ja soojuskadude vähendamiseks
- DVGW sertifitseeritud PM klapp
- Vahetükk soojusmõõtjale
- Potentsiaali ühtlustamise ühenduse võimalus (markeeritud)
- max. kütte töö rõhk: PN10
- max. tarbevee töö rõhk: PN10
- max. töötemperatuur: 85 °C
- max. kütte rõhkude vahe: 2,5 bar
- min. tarbevee rõhk: 2,0 bar
- Tarbevee liitmike materjal: CW617N
- Kütte liitmike materjal: CW617N, CW614N
- Toru materjal: roostevaba teras 1.4401

Uponor Aqua Port S 1000 S 1000

- Primaarpoole diferentsiaalrõhu juhtimine
- Termostaatiline möödviiguventiil
- Joodetud vasest plaatsoojusvaheti
- Õhueraldaja
- Külma vee filter 0,5 mm
- Primaarpoole kütte pealevoolu filter HZ-VL-PR 0,5 mm
- Külma vee sisend vahetükiga veemõõtja paigaldamiseks
- Mõõtmed: L/K/S 436 x 620 x 145 mm



| Art. nr. | Dimension | b mm | h mm | d mm | Weight kg | pakend UOM | |
|-----------------|-----------|---------|---------|---------|--------------|------------|----|
| 1089517* | 12 l/min | 436 | 620 | 145 | 14,500 | 1 | tk |
| 1089518* | 15 l/min | 436 | 620 | 145 | 15,000 | 1 | tk |
| 1089519* | 17 l/min | 436 | 620 | 145 | 16,400 | 1 | tk |
| 1089520* | 20 l/min | 436 | 620 | 145 | 17,800 | 1 | tk |

Uponor Aqua Port Central

Uponor Aqua Port Central

Kirjeldus

- Joodetud vasest plaatsoojusvaheti
- Suure efektiivsusega pump
- Kuulkraanid kütte ühendusteks
- Sulgventiilid külma tarbevee sisendil
- Plastist toru kinnitusklambrid müra ja soojuskadude vähendamiseks
- Täielikult koostatud ja survetestitud sõlm
- Potentsiaaliühtlustuse ühenduse võimalus (markeeritud)
- Tarbevee liitmike materjal: CW617N
- Kütte liitmike materjal: CW617N, CW614N
- Torude materjal: roostevaba teras 1.4401
- max. kütte töö rõhk: PN10
- max. tarbevee töö rõhk: PN10
- max. töötemperatuur: 85 °C
- Toitepinge: 230 V/50 Hz

Uponor Aqua Port Central 100 100

- DVGW sertifitseeritud PM klapp
- Sooja tarbevee segisti 45°C-65°C
- Kogu sõlm kaetud EPP isolatsiooniga
- Mõõtmed: L/K/S 450 x 700 x 283 mm
- Tootekood 1089526, komplektis tsirkulatsioonimoodul



| Art. nr. | Dimension | b mm | h mm | d mm | Weight kg | pakend | UOM |
|----------------|------------|---------|---------|---------|--------------|--------|-----|
| 1089525 | 22 l/min | 450 | 890 | 283 | 18,800 | 1 | tk |
| 1089526 | 22 l/min C | 450 | 970 | 283 | 19,100 | 1 | tk |

Uponor Aqua Port Central 200 200

- Elektroonilise juhtimisega sõlm sooja tarbevee valmistamiseks
- Komplektis tsirkulatsioonimoodul
- Sõlm täielikult kaetud EPP isolatsiooniga
- Mõõtmed: L/K/S 450 x 700 x 283 mm



| Art. nr. | Dimension | b mm | h mm | d mm | Weight kg | pakend | UOM |
|----------------|------------|---------|---------|---------|--------------|--------|-----|
| 1089527 | 25 l/min C | 450 | 970 | 283 | 22,000 | 1 | tk |
| 1089528 | 45 l/min C | 450 | 1030 | 283 | 28,500 | 1 | tk |
| 1089529 | 60 l/min C | 450 | 1090 | 283 | 35,400 | 1 | tk |

Uponor Aqua Port Central

Uponor Aqua Port Central 500 500

- Elektroonilise juhtimisega sõlm sooja tarbevee valmistamiseks
- Komplektis tsirkulatsioonimoodul
- Metallkate, valge RAL9016
- Mõõtmed: L/K/S 720 x 1090 x 550 mm



| Art. nr. | Dimension | b mm | h mm | d mm | Weight kg | pakend | UOM |
|----------------|-------------|---------|---------|---------|--------------|--------|-----|
| 1089530 | 75 l/min C | 720 | 1190 | 550 | 95,000 | 1 | tk |
| 1089531 | 100 l/min C | 720 | 1190 | 550 | 105,000 | 1 | tk |

Kerilaud, torusirgesti

Uponor MLC torusirgesti

- Toru sirgesti ei ole seotud Uponor kerilauaga



| Art. nr. | Dimension | pakend | UOM |
|----------------|-----------|--------|-----|
| 1010512 | 14-25 | 1 | tk |

Uponor Magna kerilaud juhikuga



| Art. nr. | 2. pak. | pakend | UOM |
|----------------|---------|--------|-----|
| 1035807 | 4 | 1 | tk |

Uponor Wipex klambervöö tangid

- WIPEX liitmiku klambervöö avamiseks



| Art. nr. | Dimension | l mm | Weight kg | 2. pak. | pakend | UOM |
|----------------|---------------|---------|--------------|---------|--------|-----|
| 1046407 | 1 - 1 1/2 | 145 | 0,148 | 25 | 1 | tk |
| 1046408 | 1 1/2 - 3 1/2 | 200 | 0,228 | 25 | 1 | tk |

Torulõikurid, kalibreerijad, painutusvedrud

Uponor Multi toru ja hülsi lõikur

- Kolmnurkse teraga torulõikur
- välisläbimõõdule 12-25 mm



| Art. nr. | Dimension | 2. pak. | pakend | UOM |
|----------------|-----------|----------|--------|-----|
| 1089674 | 12-25 | 36 | 1 | tk |
| 1089776 | 12-25 | varutera | 1 | tk |

Uponor Multi torulõikur

- välisläbimõõdule 25 - 63 mm



NEW

NEW

| Art. nr. | Dimension | 2. pak. | pakend | UOM |
|----------------|-----------|----------------------|--------|-----|
| 1089675 | 25-63 | 12 | 1 | tk |
| 1089777 | 25-63 | torulõikuri varutera | 1 | tk |

Uponor Flex toru lõikur PEX

- Uponor PEX torude lõikamiseks, läbimõõtudele 12-25 mm. #Terad ei ühildu Uponor torulõikuriga 1001369



NEW

NEW

| Art. nr. | Dimension | 2. pak. | pakend | UOM |
|----------------|-----------|----------|--------|-----|
| 1089673 | 12-25 | 36 | 1 | tk |
| 1089780 | 12-25 | varutera | 1 | tk |

Uponor MLC torulõikur faasija



| Art. nr. | Dimension | 2. pak. | pakend | UOM |
|----------------|-----------|---------|--------|-----|
| 1014334 | 63-110 | 32 | 1 | tk |

Uponor MLC faasilõikur

- Uponor Uni Pipe PLUS ja MLC torude faasimiseks.
- Varustatud pööraga. Ilma pöörata kasutatav koos akudrelliga.



| Art. nr. | Dimension | pakend | UOM |
|----------------|-----------|--------|-----|
| 1015762 | 32 | 1 | tk |

Uponor MLC faasilõikur



| Art. nr. | Dimension | pakend | UOM |
|----------------|-----------|--------|-----|
| 1006638 | 40 | 1 | tk |
| 1015808 | 50 | 1 | tk |
| 1014339 | 63 | 1 | tk |
| 1014344 | 75 | 1 | tk |

Torulõikurid, kalibreerijad, painutusvedrud

Uponor MLC faasilõikur

- Uponor Uni Pipe PLUS ja MLC torude faasimiseks.



| Art. nr. | Dimension | 2. pak. | pakend | UOM |
|----------------|-----------|---------|--------|-----|
| 1015739 | 16/20/25 | | 1 | tk |

Uponor MLC universaalne faasija



| Art. nr. | 2. pak. | pakend | UOM |
|----------------|---------|--------|-----|
| 1060167 | 50 | 1 | tk |

Uponor MLC sise painutusvedru

- Uponor Uni Pipe PLUS ja MLC torude painutusvedru.



| Art. nr. | Dimension | 2. pak. | pakend | UOM |
|----------------|-----------|---------|--------|-----|
| 1013729 | 16 | | 1 | tk |
| 1013734 | 20 | | 1 | tk |
| 1013737 | 25 | 50 | 1 | tk |
| 1013739 | 32 | 40 | 1 | tk |

Uponor MLC välis painutusvedru

- Uponor Uni Pipe PLUS ja MLC torude painutusvedru.



| Art. nr. | Dimension | 2. pak. | pakend | UOM |
|-----------------|-----------|---------|--------|-----|
| 1006639* | 14 | | 1 | tk |
| 1006640 | 16 | | 1 | tk |
| 1013792 | 20 | 45 | 1 | tk |
| 1013794 | 25 | 45 | 1 | tk |

Uponor Uni Pipe PLUS toru painuti

- Uponor Uni Pipe PLUS torude painutamiseks, läbimõõdud kuni 32 mm.
- Painuti koos painutus segmentidega.



| Art. nr. | Dimension | 2. pak. | pakend | UOM |
|-----------------|-----------|---------|--------|-----|
| 1071925* | 16-32 | | 1 | tk |

Torulõikurid, kalibreerijad, painutusvedrud

Uponor MLC toru painuti

- Uponor MLC torude painutamiseks, läbimõõdud kuni 32 mm.
- Painuti koos painutus segmentidega.



| Art. nr. | Dimension | 2. pak. | pakend | UOM |
|----------|-----------|---------|--------|-----|
| 1013773* | 16-32 | 48 | 1 | tk |

Uponor presstöörüistad

Uponor S-Press käsipress presspaledeta

- vahetatavate presspaledega
- Tarnitakse kohvris ilma presspaledeta



| Art. nr. | Dimension | d mm | pakend | UOM |
|----------------|-----------|---------|--------|-----|
| 1015764 | 14-20 | 14-20 | 1 | tk |

Uponor S-Press presspaled käsipressile

- Vahetatavad presspaled käsipressile



| Art. nr. | Dimension | d mm | 2. pak. | pakend | UOM |
|-----------------|-----------|---------|---------|--------|-----|
| 1015776* | 14 | 14 | 50 | 1 | tk |
| 1015777 | 16 | 16 | 50 | 1 | tk |
| 1015780 | 20 | 20 | 50 | 1 | tk |

Uponor S-Press akupress UP110 presspeadeta

- Tarnitakse kohvris koos aku ja laadijaga
- presspeadeta.
- Toruühendustele kuni 110 mm.

Tehnilised andmed:

- Lühike presstsükkel
- Pressimisjõud: lineaarne, ligikaudu 32 kN
- Aku mahtuvus: High-power Makita 3.0 Ah Li-Ion aku
- Laadimisaeg: 22 min
- Kaal koos akuga: ilma presspeata 3.5 kg
- Mõõtmed: 377 x 75 x 116 mm
- Pööratav: presspea hoidik pööratav ligikaudu 350°



| Art. nr. | 2. pak. | pakend | UOM |
|----------------|---------|--------|--------|
| 1083612 | 20 | 1 | kompl. |

Uponor SPI S-Press varuaku UP110

- Aku 18 V / 3,0 Ah, Li-Ion (54 Wh)
- Aku pingeline: 18 V
- Aku mahtuvus: 3.0 Ah
- Laadimisaeg: SPI S-PRESS akulaadijaga: 22 min
- Aku tüüp: Li-Ion
- Kaal: 0,6 kg



| Art. nr. | TP V | 2. pak. | pakend | UOM |
|-----------------|---------|---------|--------|-----|
| 1083608* | 18 | 12 | 1 | tk |

Uponor presstööriistad

Uponor S-Press elektripress presspeadeta UP75

- andmed:
- Kaal: 3.30 kg
- Toitepinge: 230 V AC / 50 Hz
- Nimivõimsus: 200 Watt
- Pressimisjõud: ca. 32 kN
- Pressimisaeg: ca. 7 sec.



| Art. nr. | d mm | TP V | 2. pak. | pakend | UOM |
|----------|---------|---------|---------|--------|-----|
| 1007082 | - 110 | 230 | 20 | 1 | tk |

Uponor S-Press presspea UPP1

- presspead Uponor MLC pressliitmikele



| Art. nr. | Dimension | d mm | pakend | UOM |
|----------|-----------|---------|--------|-----|
| 1007084 | 16 | 16 | 1 | tk |
| 1007086 | 20 | 20 | 1 | tk |
| 1007087 | 25 | 25 | 1 | tk |
| 1007088 | 32 | 32 | 1 | tk |

Uponor S-Press presspea UPP1

- presspead Uponor MLC pressliitmikele



| Art. nr. | Dimension | d mm | pakend | UOM |
|----------|-----------|---------|--------|-----|
| 1015768 | 40 | 40 | 1 | tk |
| 1015792 | 50 | 50 | 1 | tk |

Uponor S-Press pressmooduli korpus

- Presskorpus pressmoodulitele Uponor MLC pressliitmike 63 - 110 mm. Kasutatakse pressidega UP 110, UP 75 ja UP 75 EL



| Art. nr. | Dimension | d mm | pakend | UOM |
|----------|-----------|---------|--------|-----|
| 1046545 | 63-110 | 63-110 | 1 | tk |

Uponor S-Press pressmoodul

- Pressmoodul Uponor MLC pressliitmikele 63 - 110 mm, kasutatakse koos presskorpusega. Pressidele UP 110, UP 75 and UP 75 EL



| Art. nr. | Dimension | d mm | pakend | UOM |
|----------|-----------|---------|--------|-----|
| 1046541 | 63 | 63 | 1 | tk |
| 1046542 | 75 | 75 | 1 | tk |
| 1046543* | 90 | 90 | 1 | tk |
| 1046544* | 110 | 110 | 1 | tk |

Uponor presstöörüistad

Uponor S-Press akupress Mini2 KSP0 presspeadega

- Uponor S-Press akupress Mini², tarnitakse kohvris, komplektis aku, laadija ja presspead.
- Läbimõõtudele kuni 32 mm.

Tehnilised andmed:

- Pressimistsükli kestvus 3-4 sekundit
- Pressimisjõud: lineaarne, ligikaudu 15 kN
- Aku maht: High-power Makita 1.3 Ah Li-Ion aku (3.0 Ah lisavõimalus)
- Laadimisaeg: 1.5 Ah 15 min. 3.0 Ah 22 min
- Kaal koos akuga: ilma presspeadeta 1.7 kg
- Mõõtmed: 377 x 75 x 116 mm
- Pööratav: presspea hoidik pööratav ligikaudu 350°



| Art. nr. | Dimension | 2. pak. | pakend | UOM |
|----------|-------------|---------|--------|--------|
| 1083586 | 16/20/25/32 | 30 | 1 | kompl. |

Uponor SPI S-Press Mini2 aku

- Aku 18 V / 1.5 Ah, Li-Ion (27 Wh)
- Aku pinge: 18 V
- Aku mahtuvus: 1.5 Ah
- Laadimisaeg: SPI S-PRESS akulaadija: 15 min
- Aku tüüp: Li-Ion
- Kaal: 0,4 kg



| Art. nr. | TP V | 2. pak. | pakend | UOM |
|----------|---------|---------|--------|-----|
| 1083605* | 18 | 48 | 1 | tk |

Uponor SPI S-Press akulaadija

- Kiirlaadija 18V Li-Ion akudele, 230 V
- Laadimisaeg: 1.3 Ah 15 min,
3.0 Ah 22 min
- Toitepinge: 230 V AC
- Aku pinge: 18 V
- Kaal: 1,0 kg



| Art. nr. | Dimension | TP V | pakend | UOM |
|----------|--------------|---------|--------|-----|
| 1083610* | Mini2, UP110 | 230 | 1 | tk |

Uponor SPI S-Press aku Mini

- Aku: 9.6V, Uponor akupressile Mini KSP0.



| Art. nr. | TP V | pakend | UOM |
|----------|---------|--------|-----|
| 1015703* | 9.6 | 1 | tk |

Uponor presstöoriistad

Uponor S-Press presspea Mini KSP0

■ Uponor presspead MLC Mini KSP0



| Art. nr. | Dimension | d mm | 2. pak. | pakend | UOM |
|-----------------|-----------|---------|---------|--------|-----|
| 1007091* | 16 | 16 | 5 | 1 | tk |
| 1007093* | 20 | 20 | 5 | 1 | tk |
| 1007094* | 25 | 25 | 5 | 1 | tk |
| 1007095* | 32 | 32 | 5 | 1 | tk |

PEX laiendustööriistad

Uponor Q&E käsilaiendi S3,2 S5,0



| Art. nr. | Dimension | p bar | pakend | UOM |
|----------------|-----------|----------|--------|--------|
| 1004064 | 16/20/25 | 6+10 | 1 | kompl. |

Uponor Q&E laienduspea



| Art. nr. | Dimension | Tüüp | d | s | p | pakend | UOM |
|----------------|-----------|--------|----|-----|-----|--------|-----|
| | | - | mm | mm | bar | | |
| 1004006 | 32x2,9 | 32x2.9 | 32 | 2,9 | 6 | 1 | tk |

Uponor Q&E laienduspea



| Art. nr. | Dimension | Tüüp | d | s | p | pakend | UOM |
|----------------|-----------|--------|----|-----|-----|--------|-----|
| | | - | mm | mm | bar | | |
| 1004059 | 16x2,2 | 16x2.2 | 16 | 2,2 | 10 | 1 | tk |

Uponor Q&E akulaiendi laienduspeadega M12



| Art. nr. | Dimension | p | stroke | pakend | UOM |
|----------------|----------------|-----|--------|--------|--------|
| | | bar | mm | | |
| 1057166 | 16/20/25 6bar | 6 | 14 | 1 | kompl. |
| 1057167 | 16/20/25 10bar | 10 | 14 | 1 | kompl. |

Uponor Q&E laienduspea M12/M18



| Art. nr. | Dimension | d | s | p | stroke | pakend | UOM |
|-----------------|----------------|----|-------------|------|--------|--------|-----|
| | | mm | mm | bar | mm | | |
| 1057172 | 16x1,8/2,0/2,2 | 16 | 1,8/2,0/2,2 | 6+10 | 14/25 | 1 | tk |
| 1057173* | 20x1,9/2,0 | 20 | 1,9/2,0 | 6 | 14/25 | 1 | tk |
| 1057174 | 20x2,8 | 20 | 2,8 | 10 | 14/25 | 1 | tk |
| 1057175 | 25x2,3 | 25 | 2,3 | 6 | 14/25 | 1 | tk |
| 1057176 | 25x3,5 | 25 | 3,5 | 10 | 14/25 | 1 | tk |
| 1057177 | 32x2,9 | 32 | 2,9 | 6 | 14/25 | 1 | tk |

Uponor Q&E varuaku M12



| Art. nr. | Dimension | 2. pak. | pakend | UOM |
|----------------|-----------|---------|--------|-----|
| 1061185 | 4Ah | 12 | 1 | tk |

PEX laiendustööriistad

Uponor Q&E akulaiendi laienduspeadega M18 6bar



| Art. nr. | Dimension | p bar | stroke mm | pakend | UOM |
|----------------|-------------|----------|--------------|--------|--------|
| 1063908 | 16/20/25/32 | 6 | 25 | 1 | kompl. |

Uponor Q&E akulaiendi laienduspeadega M18 10bar



| Art. nr. | Dimension | p bar | stroke mm | pakend | UOM |
|----------------|--------------|----------|--------------|--------|--------|
| 1063909 | 16/20/25/H32 | 10 | 25 | 1 | kompl. |

Uponor Q&E laienduspea M18 H



| Art. nr. | Dimension | d mm | s mm | p bar | stroke mm | pakend | UOM |
|----------------|------------|---------|---------|----------|--------------|--------|-----|
| 1057182 | 32x2,9/4,4 | 32 | 2,9/4,4 | 6+10 | 25 | 1 | tk |
| 1057183 | 40x3,7 | 40 | 3,7 | 6 | 25 | 1 | tk |

Uponor Q&E akulaiendi M18 VLD PEX



| Art. nr. | Dimension | stroke mm | pakend | UOM |
|----------------|-----------|--------------|--------|-----|
| 1085099 | 40-75 | 56 | 1 | tk |

Uponor Q&E laienduspea VLD



| Art. nr. | Dimension | d mm | s mm | p bar | stroke mm | pakend | UOM |
|----------------|-------------|---------|----------|----------|--------------|--------|-----|
| 1085095 | 40x3,7/5,5 | 40 | 3,7/5,5 | 6+10 | 56 | 1 | tk |
| 1085096 | 50x4,6/6,9 | 50 | 4,6/6,9 | 6+10 | 56 | 1 | tk |
| 1085097 | 63x5,8/8,6 | 63 | 5,8/8,6 | 6+10 | 56 | 1 | tk |
| 1085098 | 75x6,8/10,3 | 75 | 6,8/10,3 | 6+10 | 56 | 1 | tk |

PEX laiendustööriistad

Uponor SPI Q&E akulaiendi varuaku M18 PEX



| Art. nr. | Dimension | pakend | UOM |
|-----------------|-----------|--------|-----|
| 1085100* | 5,0Ah | 1 | tk |

Uponor Q&E grafiitmääre



| Art. nr. | Dimension | Weight kg | pakend | UOM |
|----------------|-----------|--------------|--------|-----|
| 1008334 | 30g | 0,030 | 20 | tk |

Kinnitustööriistad

Uponor Tacker klambripaigaldi

- Tacker klambripaigaldi
- kasutatakse koos Uponor Tacker klambritega



| Art. nr. | Dimension | 2. pak. | pakend | UOM |
|----------------|-----------------|---------|--------|-----|
| 1002295 | 14-20mm l=700mm | 32 | 1 | tk |

Uponor Multi sidumiskonks

- sidumistraadi sidumiseks torude kinnitamisel armatuurvõrgule



| Art. nr. | pakend | UOM |
|-----------------|--------|-----|
| 1034533* | 1 | tk |

Muud tööriistad

Uponor Smart Aqua PLUS põlve paigaldi M7

- Paigaldusabinõu



| Art. nr. | Dimension | 2. pak. | pakend | UOM |
|----------------|-----------|---------|--------|-----|
| 1062944 | G1/2"MT | 20 | 1 | tk |

Uponor Smart Aqua PLUS karbi frees M7

- Aqua Plus ühenduskarbi frees
- Karp freesitakse kuni 3 mm seinapinnast
- Kasutakse koos elektritrelliga



| Art. nr. | 2. pak. | pakend | UOM |
|----------------|---------|--------|-----|
| 1062950 | 25 | 1 | tk |

Uponor Vario PLUS ventiili võti

- Võti kollektori ventiilide vahetamiseks



| Art. nr. | 2. pak. | pakend | UOM |
|----------------|---------|--------|-----|
| 1009216 | 10 | 1 | tk |

Põrandaküttekollektorid ja ajamid

Uponor

Kontrolli kollektori ja ajami sobivust

UPONOR VARIO M PLASTKOLLEKTORID EUROKOONUSLIITMIKUTEGA



| | Uponor-nr | Väljundid |
|-------------|-----------|-----------|
| 2x3/4 Euro | 1085944 | 2 |
| 3x3/4 Euro | 1085945 | 3 |
| 4x3/4 Euro | 1085946 | 4 |
| 5x3/4 Euro | 1085947 | 5 |
| 6x3/4 Euro | 1085948 | 6 |
| 7x3/4 Euro | 1085949 | 7 |
| 8x3/4 Euro | 1085950 | 8 |
| 9x3/4 Euro | 1085951 | 9 |
| 10x3/4 Euro | 1085952 | 10 |
| 11x3/4 Euro | 1086250 | 11 |
| 12x3/4 Euro | 1086251 | 12 |

Uponor Vario - sulgventiil, sirge



| | Uponor-nr |
|----------|-----------|
| NP G1-G1 | 1059132 |

Uponor Vario -seadeventiil



| | Uponor-nr |
|--------|-----------|
| G1-Rp1 | 1005100 |

Tagasivoolu-ventiil



| Uponor-nr |
|-----------|
| 1085957 |

Vooluhulga regulaator



| Uponor-nr |
|-----------|
| 1085956 |

UPONOR VARIO SMART SURVELIITMIKUD



Eurokoonus

| G3/4" FTE | Uponor-nr |
|-----------|-----------|
| 14x2,0 | 1086580 |
| 16x2,0 | 1086582 |
| 20x2,0 | 1086583 |

UPONOR VARIO PEX -LIITMIKUD



Eurokoonus

| G3/4" FT EC | Uponor-nr |
|--------------|-----------|
| 16x1,8 / 2,0 | 1065284 |
| 20x1,9 / 2,0 | 1065290 |

UPONOR VARIO S RST -KOLLEKTORID

Uponor Vario S -kollektor
Eurokoonus liitmikutega

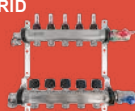

| | Uponor-nr | Väljundid |
|----------------|-----------|-----------|
| FM 2X3/4 Euro | 1086538 | 2 |
| FM 3x3/4 Euro | 1086539 | 3 |
| FM 4x3/4 Euro | 1086540 | 4 |
| FM 5x3/4 Euro | 1086541 | 5 |
| FM 6x3/4 Euro | 1086542 | 6 |
| FM 7X3/4 Euro | 1086543 | 7 |
| FM 8x3/4 Euro | 1086544 | 8 |
| FM 9x3/4 Euro | 1086545 | 9 |
| FM 10x3/4 Euro | 1086546 | 10 |
| FM 11x3/4 Euro | 1086547 | 11 |
| FM 12x3/4 Euro | 1086548 | 12 |

Uponor Vario - sulgventiil, sirge



| | Uponor-nr |
|----------|-----------|
| NP G1-G1 | 1059132 |

Uponor Vario -seadeventiil



| | Uponor-nr |
|--------|-----------|
| G1-Rp1 | 1005100 |

Tagasivoolu-ventiil



| Uponor-nr |
|-----------|
| 1087609 |

Vooluhulga regulaator



| Uponor-nr |
|-----------|
| 1087608 |

UPONOR VARIO S JA M -AJAM 230 V JA 24 V



| Vario S | Uponor-nr | Pinge V |
|---------|-----------|---------|
| 230 V | 1087763 | 230 |
| 24 V | 1087778 | 24 |

UPONOR SMATRIX RETROFIT -AJAM 24 V

Ühendamiseks teiste tootjate kollektoritele



| | Uponor-nr | Pinge V |
|-------------------|-----------|---------|
| A-XXX 24V, NC, 1W | 1083575 | 24 |

Varuosad

UPONOR VARIO B -KOLLEKTORI VARUOSAD



Vario B -pealevoolu-ventiil WGF

| Uponor-nr |
|-----------|
| 1034556 |



Vario B -vooluhulga regulaator WGF

| Uponor-nr |
|-----------|
| 1009142 |



UPONOR VARIO B -AJAM



| Uponor Vario B - toimilaite | Uponor-nr |
|-----------------------------|-----------|
| PRO 1W NC 24 V | 1090264 |
| PRO 1W NC 230 V | 1090265 |

UPONOR VARIO PLUS -KOLLEKTORI VARUOSAD

Uponor Vario PLUS -kollektor
Q&E-ühendus



Vooluhulga regulaator

| Uponor-nr |
|-----------|
| 1009217 |



Tagasivooluventiil

| Uponor-nr |
|-----------|
| 1005250 |



Peavooluventiil

| Uponor-nr |
|-----------|
| 1034523 |



UPONOR VARIO PLUS -AJAM PRO 1W NC



| Uponor Vario PLUS - ajam | Uponor-nr |
|--------------------------|-----------|
| PRO 1W NC 24 V | 1090262 |
| PRO 1W NC 230 V | 1090263 |

Push-12 pump

| Uponor-nr |
|-----------|
| 1095132 |



Push-23 pump

| Uponor-nr |
|-----------|
| 1059854 |



Push pumbagrupi termostaat

| Uponor-nr |
|-----------|
| 1063461 |



uponor

Kõik ühes rakenduses: Uponor PRO App

Tooteteave, paigaldusjuhendid, edasimüüjate info, kontaktid ja Uponor & More preemiaprogramm alati käepärast.

Lae alla või uuenda Uponor PRO rakendus:

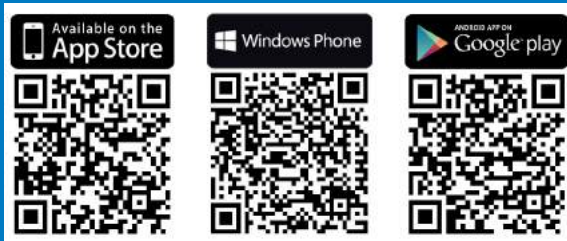

Uponor Eesti OÜ
Osmussaare 8
13811
Eesti

Tehniline tugi **+372 605 2089**

T +372 605 2070
E uponor.estonia@uponor.com

04/2020



www.uponor.ee