

EMSKV 20

Cable gland, brass nickel-plated, M20, with short thread

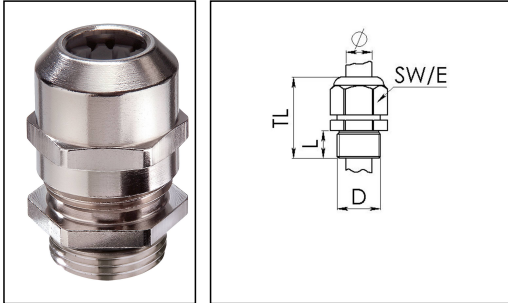

Products may differ in size, colour and appearance to those shown. If you require further information or customisation, please contact us directly.



Material cable gland	Brass nickel-plated
Material clamping cage	Polyamide
Material sealing gasket	EPDM
Temp. range min	-40 °C
Temp. range max	100 °C
Protection class	IP68 (5 bar 30 min), IP69
Thread type	M
Ø Connection thread D	20
Lead	1,5
Length screw-in thread L	6 mm
Ø cable diameter min	6 mm
Ø cable diameter max	13 mm
Ø cable diameter UL	7,5 mm - 11,3 mm
Key width SW	24 mm
Collar diameter (E)	27 mm
Total length TL	29 mm - 37 mm
Type of cable anchorage	A
Install. torques fitting	8 N m
Install. torques cap nut	8 N m
Impact category	6
Surface	Nickel-plated
Order no. nickel-plated	10065002
Packing unit	50
Type	EMSKV 20
ETIM-Classification	EC000441

Your Contact:

WISKA Hoppmann GmbH

Kisdorfer Weg 28 · 24568 Kaltenkirchen · Germany

☎ +49-4191-508-0 · 📠 +49-4191-508-209

contact@wiska.de · www.wiska.com

Recommended accessories

MFD 20/02/065	10060953
RDE 20	10062185
EMMU 20	10063143
BS 13	10064010
MFD 20/03/040	10064341
MFD 20/02/060	10064395
MFD 20/02/050	10101015
MFD 20/03/045	10102306

17.02.2021

Your Contact:

WISKA Hoppmann GmbH

Kisdorfer Weg 28 · 24568 Kaltenkirchen · Germany

 +49-4191-508-0 ·  +49-4191-508-209

contact@wiska.de · www.wiska.com



Your Contact:

WISKA Hoppmann GmbH

Kisdorfer Weg 28 · 24568 Kaltenkirchen · Germany

☎ +49-4191-508-0 · 📠 +49-4191-508-209

contact@wiska.de · www.wiska.com