

EMUG 63

Locknut, polyamide, RAL 7035, M63

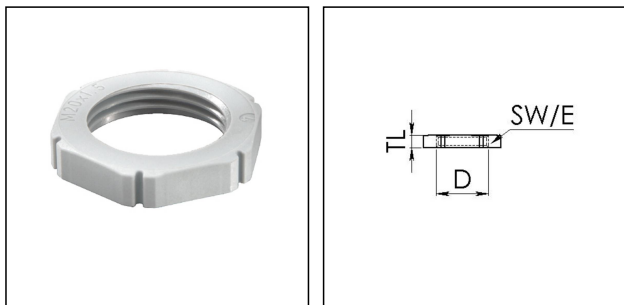

Products may differ in size, colour and appearance to those shown. If you require further information or customisation, please contact us directly.





Material	Polyamide, fibre reinforced
Temp. range min	-40 °C
Temp. range max	100 °C
Glow wire test	650 °C
Thread type	M
Ø Connection thread D	63
Lead	1,5
Total length TL	7 mm
Key width SW	75 mm
Collar diameter (E)	83 mm
Product Color	RAL 7035
Order no. RAL 7035	10060777
Type	EMUG 63
Packing unit	10
ETIM-Classification	EC000940

05.01.2021

Your Contact:

WISKA Hoppmann GmbH

Kisdorfer Weg 28 · 24568 Kaltenkirchen · Germany

☎ +49-4191-508-0 · 📠 +49-4191-508-209

contact@wiska.de · www.wiska.com



Your Contact:

WISKA Hoppmann GmbH

Kisdorfer Weg 28 · 24568 Kaltenkirchen · Germany

☎ +49-4191-508-0 · 📠 +49-4191-508-209

contact@wiska.de · www.wiska.com