

## EMUG 40

Locknut, polyamide, RAL 7035, M40

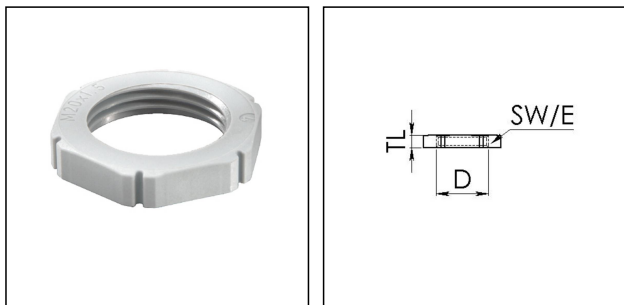

Products may differ in size, colour and appearance to those shown. If you require further information or customisation, please contact us directly.



<b>Material</b>	Polyamide, fibre reinforced
<b>Temp. range min</b>	-40 °C
<b>Temp. range max</b>	100 °C
<b>Glow wire test</b>	650 °C
<b>Thread type</b>	M
<b>Ø Connection thread D</b>	40
<b>Lead</b>	1,5
<b>Total length TL</b>	7 mm
<b>Key width SW</b>	50 mm
<b>Collar diameter (E)</b>	55 mm
<b>Product Color</b>	RAL 7035
<b>Order no. RAL 7035</b>	10060775
<b>Type</b>	EMUG 40
<b>Packing unit</b>	50
<b>ETIM-Classification</b>	EC000940

05.01.2021

Your Contact:

**WISKA Hoppmann GmbH**

Kisdorfer Weg 28 · 24568 Kaltenkirchen · Germany

☎ +49-4191-508-0 · 📠 +49-4191-508-209

contact@wiska.de · www.wiska.com



Your Contact:

**WISKA Hoppmann GmbH**

Kisdorfer Weg 28 · 24568 Kaltenkirchen · Germany

☎ +49-4191-508-0 · 📠 +49-4191-508-209

contact@wiska.de · www.wiska.com