

PA2DR

Oviovhjus PA2200C kojeille
Käyttö- ja asennusohje

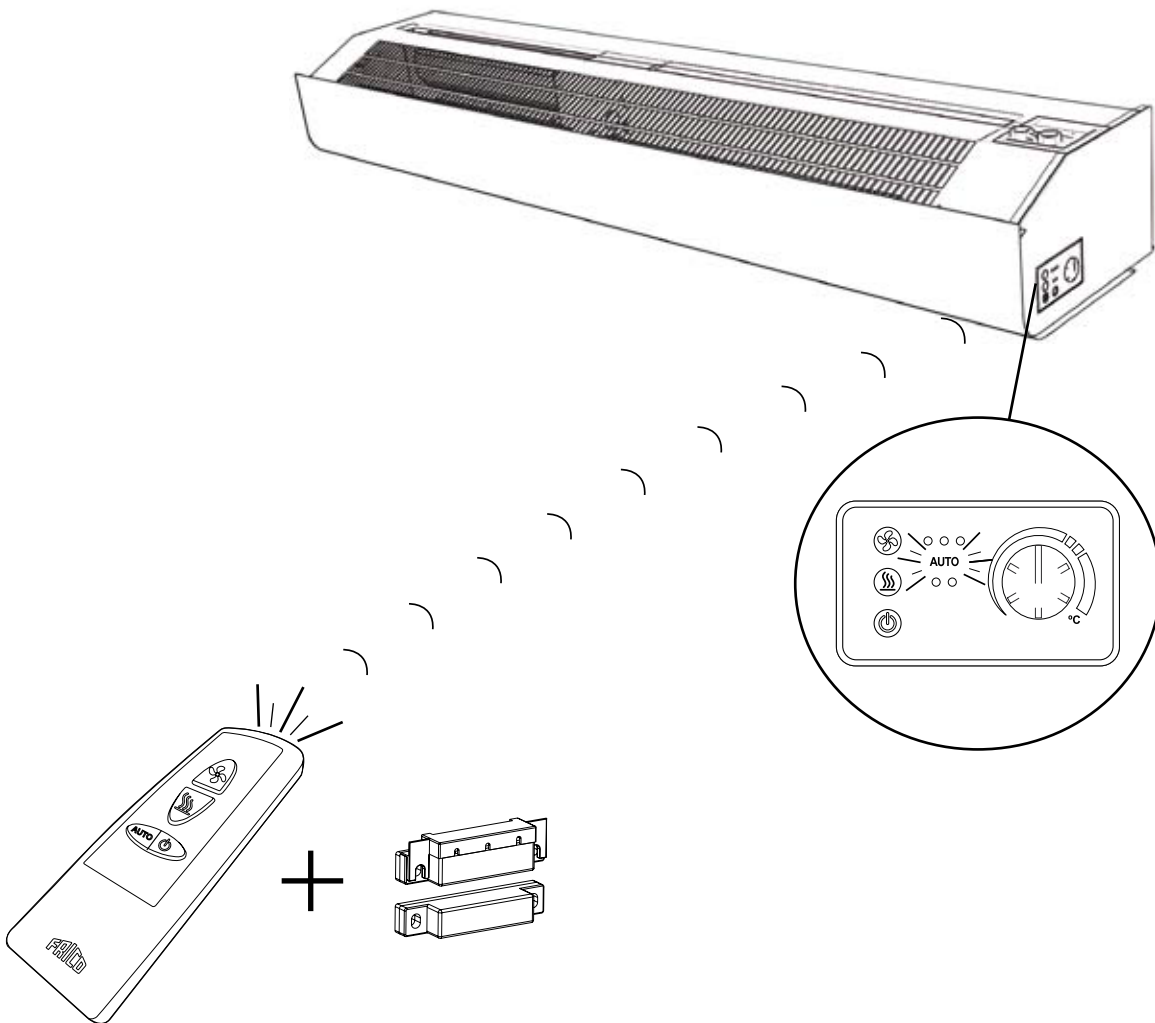

PA2DR

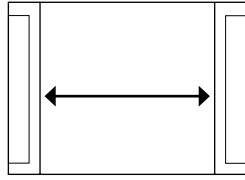
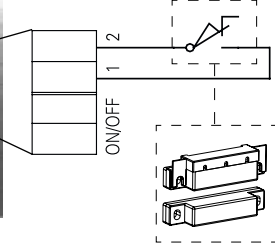
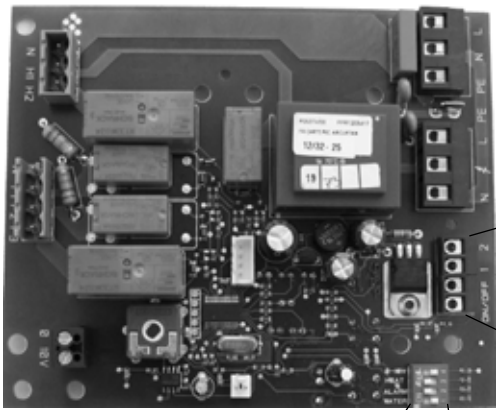

ON

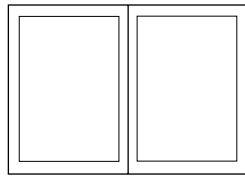
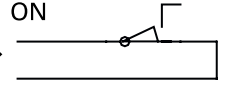

OFF

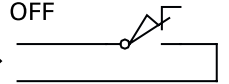

0-10V		4
HEAT		3
ALARM		2
WATER		1

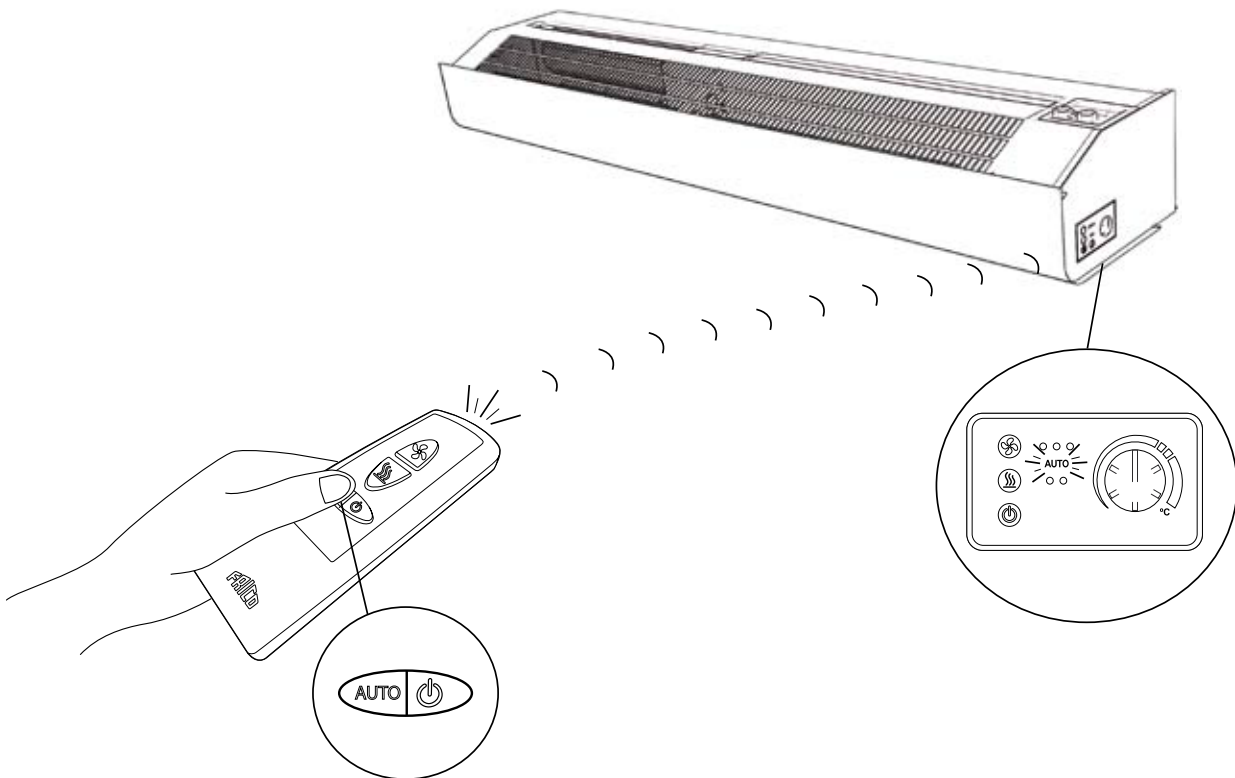
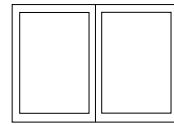

Funktion/ Function/ Toiminta

(A)

Exempel/
Examples/
Esimerkki

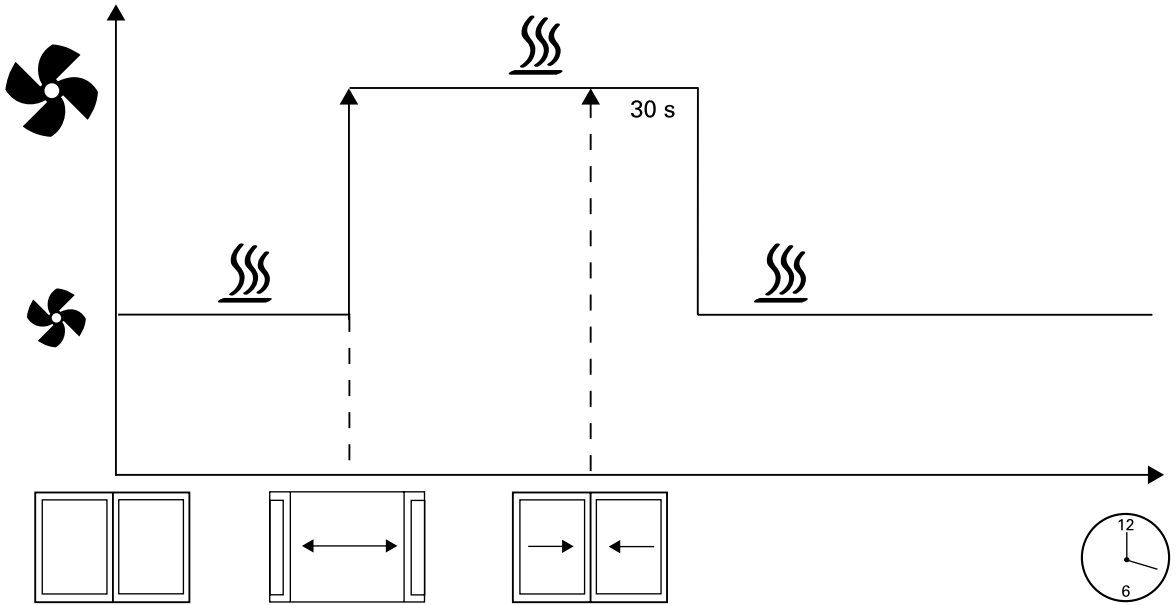
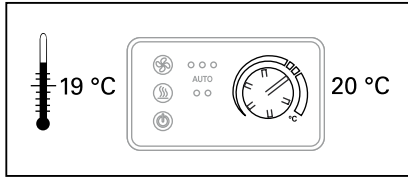

(B)

Exempel/
Examples/
Esimerkki

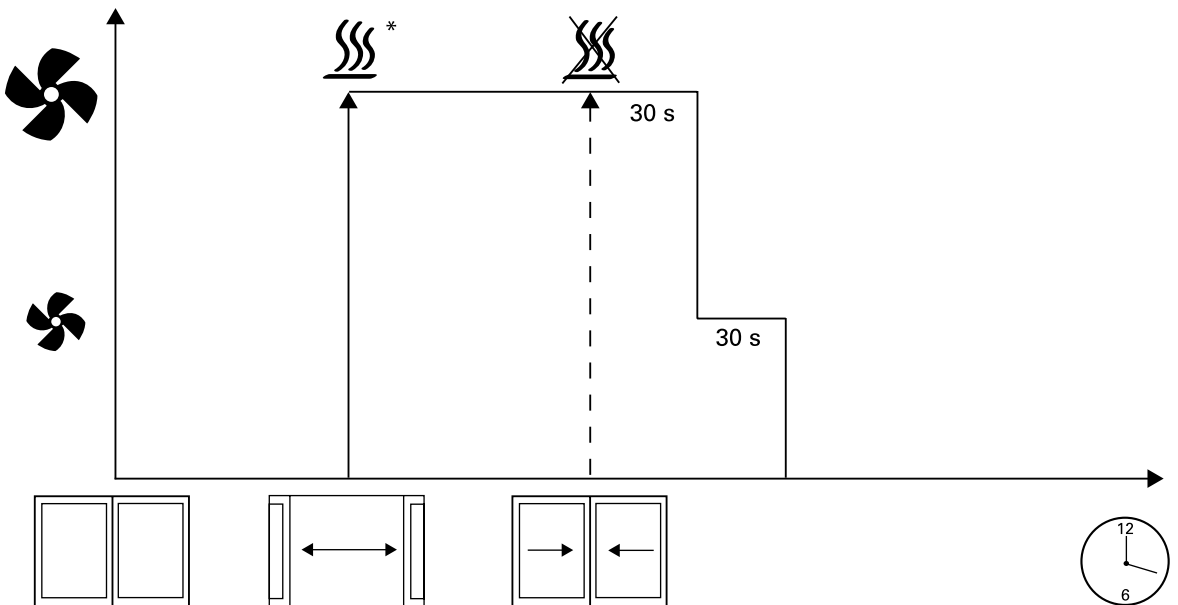
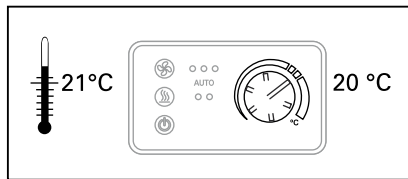

*Under tiden dörren är öppen ökar börvärdet automatiskt med 2 °C. / While the door is open the set point will automatically increase with 2 °C. / Oven aukiollessa lämpötilan asetuspistettä nostetaan automaattisesti 2 °C.



Hedengren yhtiö
Lauttasaarentie 50, 00200 Helsinki
Puh. 0207 638 000
www.hedtec.fi