



HOW TO INSTALL A FRONIUS SMART METER 63A-1 AND 63A-3

*for 63A-1, 63A-3 whole current Fronius Smart Meters only. For the 50kA Fronius Smart Meter and 240V/480V UL Fronius Smart Meters please refer to their respective guides.

Quick Guide

© Fronius Australia Pty Ltd.,

Version 3.0/2019

Fronius reserves all rights, in particular rights of reproduction, distribution and translation. No part of this work may be reproduced in any way without the written consent of Fronius. It must not be saved, edited, reproduced or distributed using any electrical or electronic system. You are hereby reminded that the information published in this document, despite exercising the greatest of care in its preparation, is subject to change and that neither the author nor Fronius can accept any legal liability. Gender-specific wording refers equally to female and male form.



1. GENERAL

Fronius Smart Meters are energy meters which can be used to measure consumption data of a site, or for export limitation of a PV system with the Fronius SnapINverter range.

The Fronius Smart Meter measures the power flow to the loads, or grid, and feeds the information via ModBus RTU/ RS485 communication to the Fronius Datamanager 2.0 (comes built-in with Fronius Galvo, Primo, Symo and Eco SnapINverters, excluding Light versions. It can also be retrofitted to all other Fronius inverters).



This document describes how to install and set up only the 63A-1 single phase or 63A-3 3-phase Fronius Smart Meters. Please use the below links if using a different model of Fronius Smart Meter.

Further information about the entire range of Fronius Smart Meters can be found in our Fronius Smart Meter Application Guide:

https://www.fronius.com/~/downloads/Solar%20Energy/Whitepaper/SE_WP_Fronius_Smart_Meter_Application_Guide_EN_AU.pdf

For installation and setup instructions of the 240V1-UL or 480V3-UL Fronius Smart Meters refer to the following document:

[https://www.fronius.com/~downloads/Solar%20Energy/Operating%20Instructions/42%2C0410%2C2289.pdf](https://www.fronius.com/~/downloads/Solar%20Energy/Operating%20Instructions/42%2C0410%2C2289.pdf)

For installation and setup instructions of the 50kA-3 Fronius Smart Meter refer to the following document:

[https://www.fronius.com/~downloads/Solar%20Energy/Technical%20Articles/SE_TEA_Quick_Guide_How_to_install_and_commission_a_Fronius_Smart_Meter_50kA-3_EN_AU.pdf](https://www.fronius.com/~/downloads/Solar%20Energy/Technical%20Articles/SE_TEA_Quick_Guide_How_to_install_and_commission_a_Fronius_Smart_Meter_50kA-3_EN_AU.pdf)

The document for setting export limitation with the Fronius Smart Meter can be found here:

[https://www.fronius.com/~downloads/Solar%20Energy/Technical%20Articles/SE_TEA_Quick_Guide_How_to_set_up_Export_Limiting_using_the_Fronius_Smart_Meter_EN_AU.pdf](https://www.fronius.com/~/downloads/Solar%20Energy/Technical%20Articles/SE_TEA_Quick_Guide_How_to_set_up_Export_Limiting_using_the_Fronius_Smart_Meter_EN_AU.pdf)

1.1 Location of the Fronius Smart Meter

With the Fronius Smart Meter there are two possible energy paths/ locations where it can be installed.

In almost all cases, the Fronius Smart Meter will be installed in the **feed-in path**. This is also the default setting in the Datamanager's METER section.

/ Feed-in point

In this position the **Solar Supply Main Switch** is on the **load side** of the Fronius Smart Meter

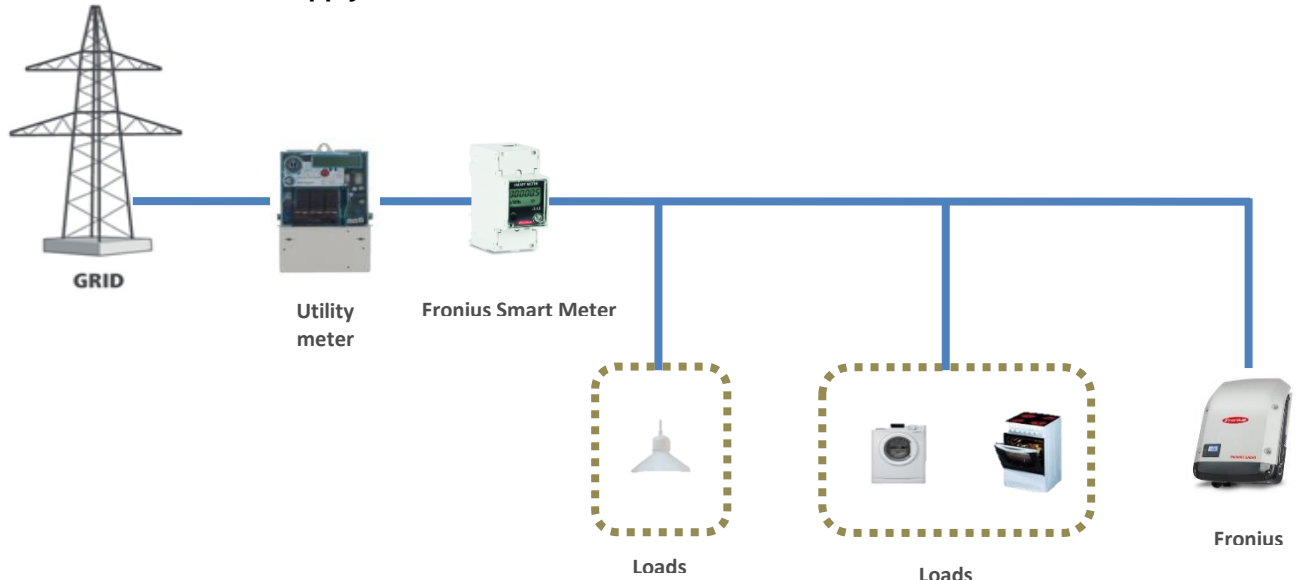

/ Consumption path

In this position the **Solar Supply Main Switch** is on the **grid side** of the Fronius Smart Meter

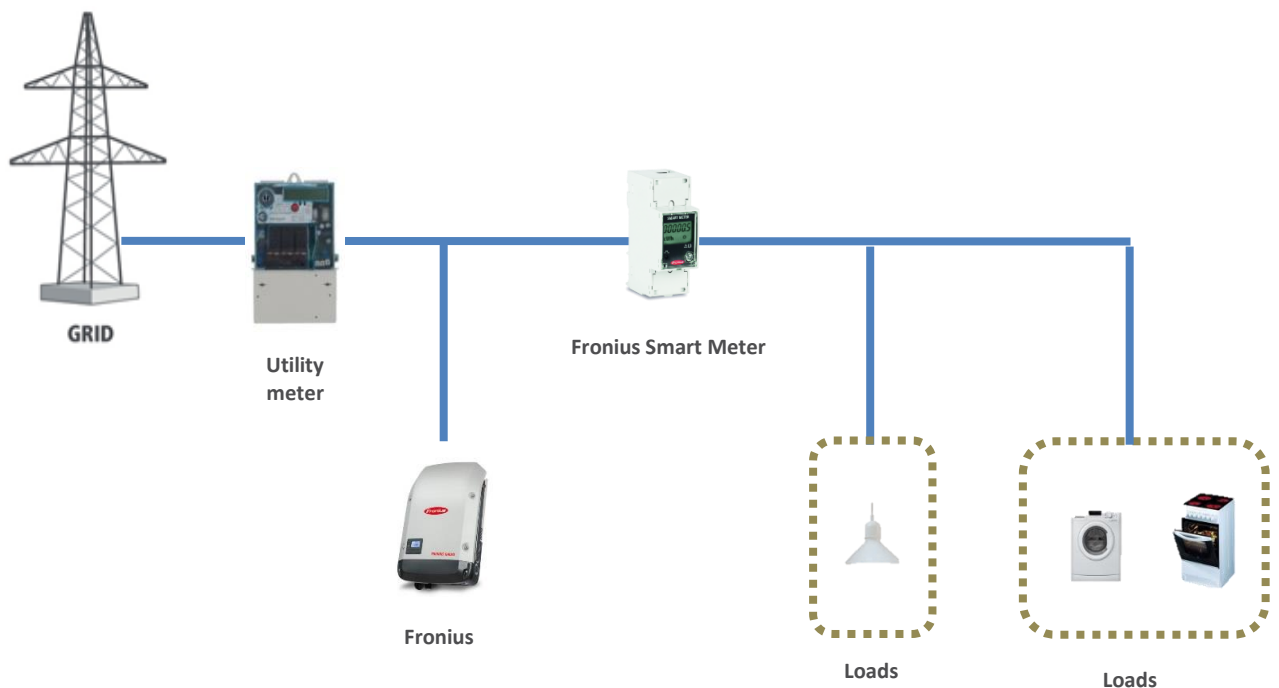

2. INSTALLING AND ACTIVATING A FRONIUS SMART METER

2.1 Schematics and wiring requirements

/ Wiring between Fronius Smart Meter and inverter should use a CAT5 or CAT6 cable.

Important: To be compliant with the AS3000 standards, it is recommended to have the CAT5/CAT6 cable in a heat shrink tubing (probably 10mm) when it enters the switchboard part. Alternatively, use a 240V rated CAT5/CAT6 cable (e.g. Clipsal CBUS cable).

Please note: Use a torque screw driver with a rating of 1.2 Nm – 1.4 Nm for the AC cable input terminals (Lin, Lout and Neutral) and a torque rating of 0.5 Nm – 0.8 Nm for the RS485 terminals. Any torque rating above the prescribed limits will damage the meter terminals and will not be covered under warranty.

/ Connection is a data line for Modbus RTU / RS485 using screw terminals on the meter.

/ Maximum distance: 300 m (980 feet)

/ Use a single core per terminal connection between Fronius Smart Meter and Datamanager 2.0. For D+ and D- use the single cores from the same colour (e.g. D+ is orange/white, D- is orange)

Meter connection on the Datamanager 2.0

The meter needs to be connected to the Datamanager's terminal block using terminals D+, D- and -.

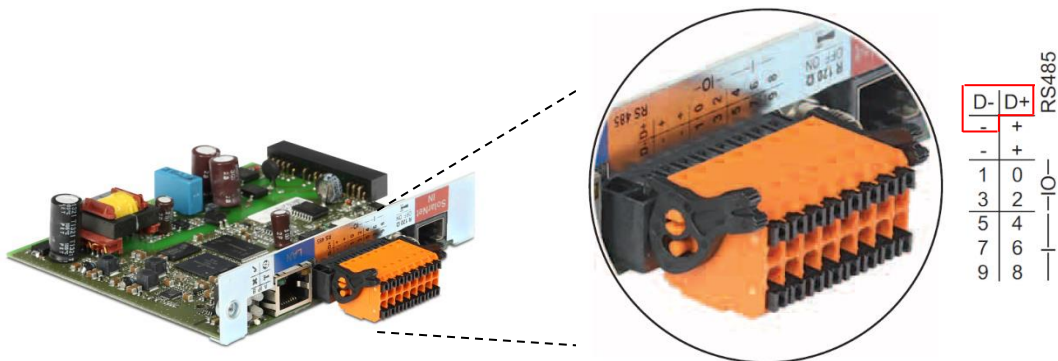



2.1.1 - Wiring detail for single-phase Fronius Smart Meter 63A/1PH & Datamanager 2.0

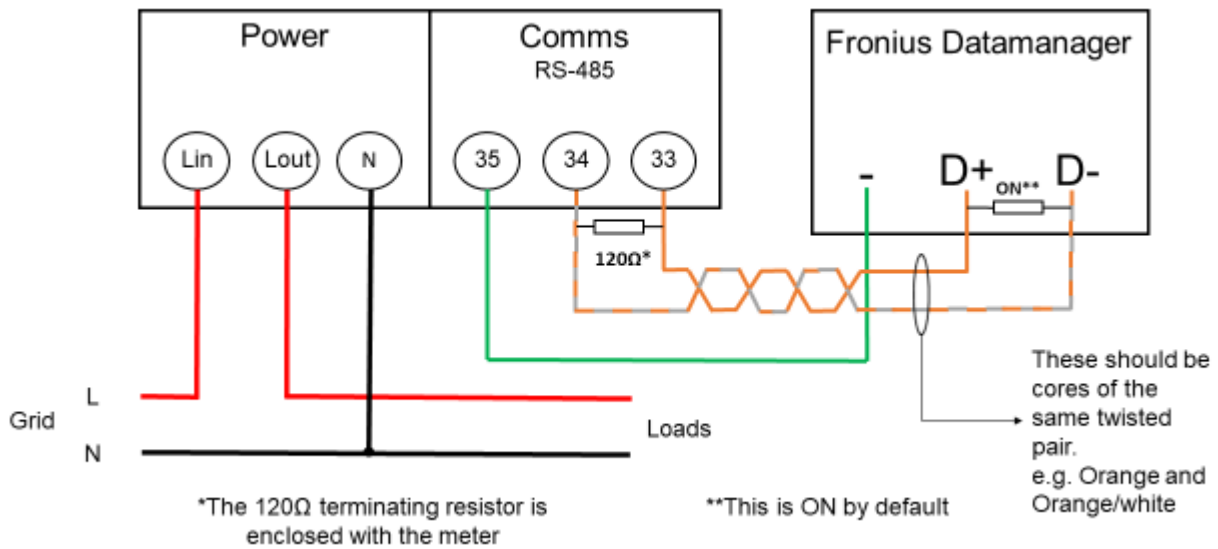

2.1.2 - Wiring detail for three-phase Fronius Smart Meter 63A/3PH and Datamanager 2.0

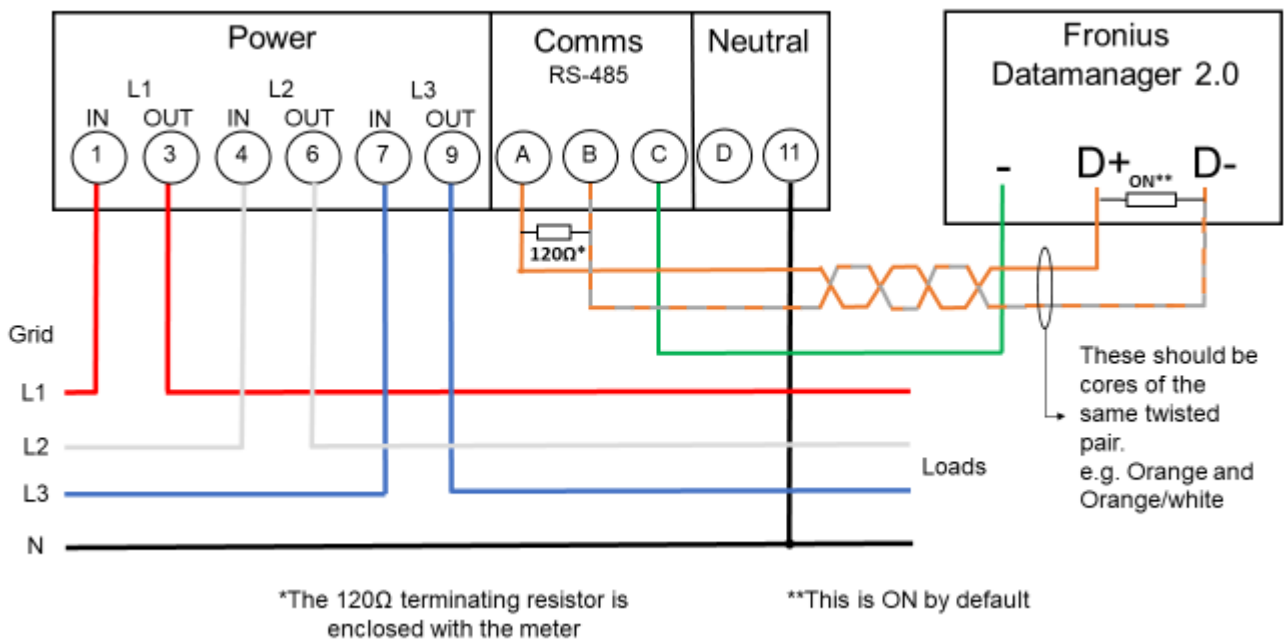

Modbus termination switch on the Datamanager

The internal bus termination 120-Ohm resistance (for Modbus RTU) needs to be switched to ON. **This switch is set to ON by default.**

Please Note: The termination resistance must be activated for the first and last device in an RS485 bus.



2.2 Activating the Fronius Smart Meter

*It is recommended to complete the Solar.web Wizard first and get the system online. Once completed please go to **Section 2.2.1** for the Fronius Smart Meter activation.*

*If the system is not being set up for online monitoring, the Fronius Smart Meter can be activated within the **Technician Wizard** as per **Section 2.2.2**.*

2.2.1 Activating the Fronius Smart Meter in the PV inverter homepage

The PV Inverter homepage can be accessed in two ways:

1. Via the Wi-Fi Access Point:
 - Activate the Wi-Fi Access Point on the Datamanager card (inverter screen under *Setup*) or Datamanager Box 2.0
 - Connect your computer/tablet/smart phone to the **Fronius_240.XXXXXX** network
 - Open a web browser and go to <http://192.168.250.181>.
 - Alternatively you can use the Fronius Solar.web App (Tablet/Smart Phone), open the Solar.web app and select *Settings*. Then select "PV Inverter Homepage" or "Your System Monitoring" depending on your device.
2. Via the LAN Port:
 - Connect your computer to the Datamanager via LAN cable
 - Switch the Datamanager IP Switch to Position 'A'
 - Open a web browser and go to <http://169.254.0.180>

Once connected follow the below steps:

The screenshot displays the Fronius Australia PV inverter homepage. On the left, the 'System overview' section shows 'Actual' data with a power output of 501 W and a total energy yield of 808 kWh. Below this, it provides 'Day' and 'Year' statistics: Day Energy (810 Wh, Yield 0.38) and Year Energy (3710.23 kWh, Yield 1,743.81). The main area features a performance graph with a y-axis from 0% to 100% and two data points labeled 1 and 2. On the right, a navigation menu includes 'Actual data', 'Actual general view', 'Services', 'System information', 'Network diagnostics', 'Firmware update', 'Start assistant', and 'Settings'. A red callout box labeled 'Step 1 Select Settings' points to the 'Settings' option in the menu.



Step 2
Select **PASSWORDS**

Step 3
Set a service password.
Minimum 8 characters with numbers and letters

Step 4
Select the tick to save the new password

Step 5
Select **METER** tab

Step 6
Login with *Username: service* and the password from Step 3

Step 7
Select Fronius Smart Meter from the drop down menu

Step 8
Select the *Settings* button

Meter settings

Primary meter:
Meter: **Fronius Smart Meter** Settings

Secondary meter:
Meter: None selected + Add

Download a schematic diagram of the wiring.

Note: when connecting a Fronius Smart Meter, Modbus RTU is automatically disabled.

Configuration positions
Note: The picture below is only an example intended to describe the position of secondary meters. A configuration is not possible here.

PV generator External producer
Generator meter 3000 W DNO grid

Step 9
Leave this window open until the State changes to *OK* or *Timeout*

Meter settings

Primary meter:
Meter: Fronius Smart Meter Settings

Secondary meter:
Meter: None selected + Add

List of configured meters:

Meter type	Location of the meter
Fronius Smart Meter	Feed-in point

Note: when connecting a Fronius Smart Meter, Modbus RTU is automatically disabled.

Note dialog:
The meter has been activated and should provide data soon. Please wait a moment!
State: looking for the meter

Step 10
If State is *OK* then set meter location. Refer to Section 1.1 of this guide for explanation of locations

If the State is *Timeout* then retry the process. If it still times out refer to troubleshooting steps at the end of this guide

Step 11
Select *OK* to go back to the Meters Overview page

Meter settings

Secondary meter:
Meter: None selected + Add

List of configured meters:

Meter type	Location of the meter
Fronius Smart Meter	Feed-in point

Note dialog:
State: **OK** Power: 6 W
Location of the meter: Feed-in point Consumption path
Modbus address: 1
Serial number: 15070170

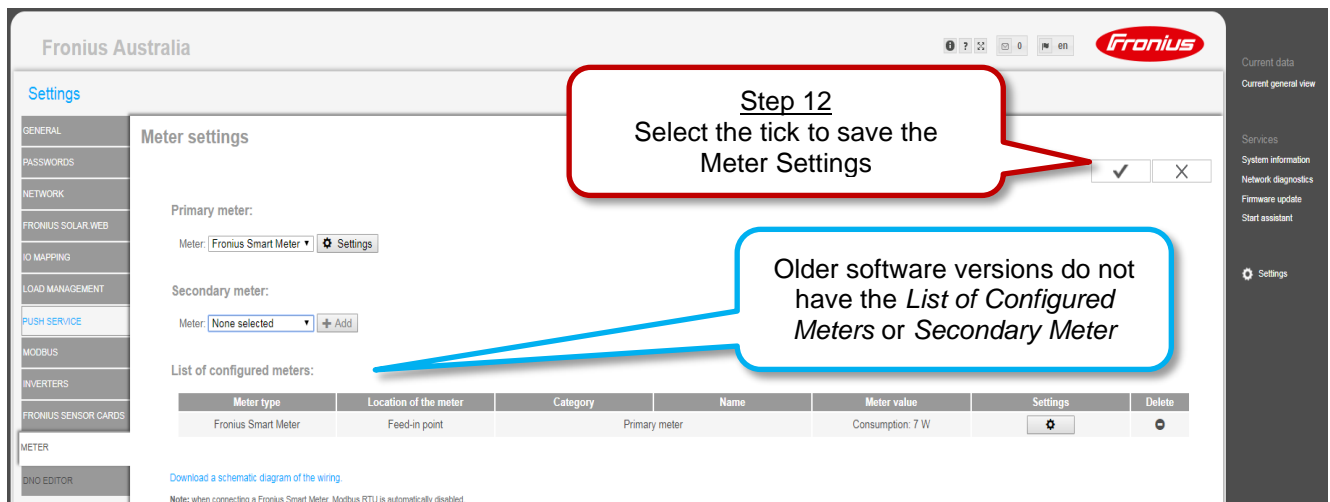

Step 12
Select the tick to save the Meter Settings

Older software versions do not have the *List of Configured Meters* or *Secondary Meter*

Meter type	Location of the meter	Category	Name	Meter value	Settings	Delete
Fronius Smart Meter	Feed-in point	Primary meter		Consumption: 7 W		

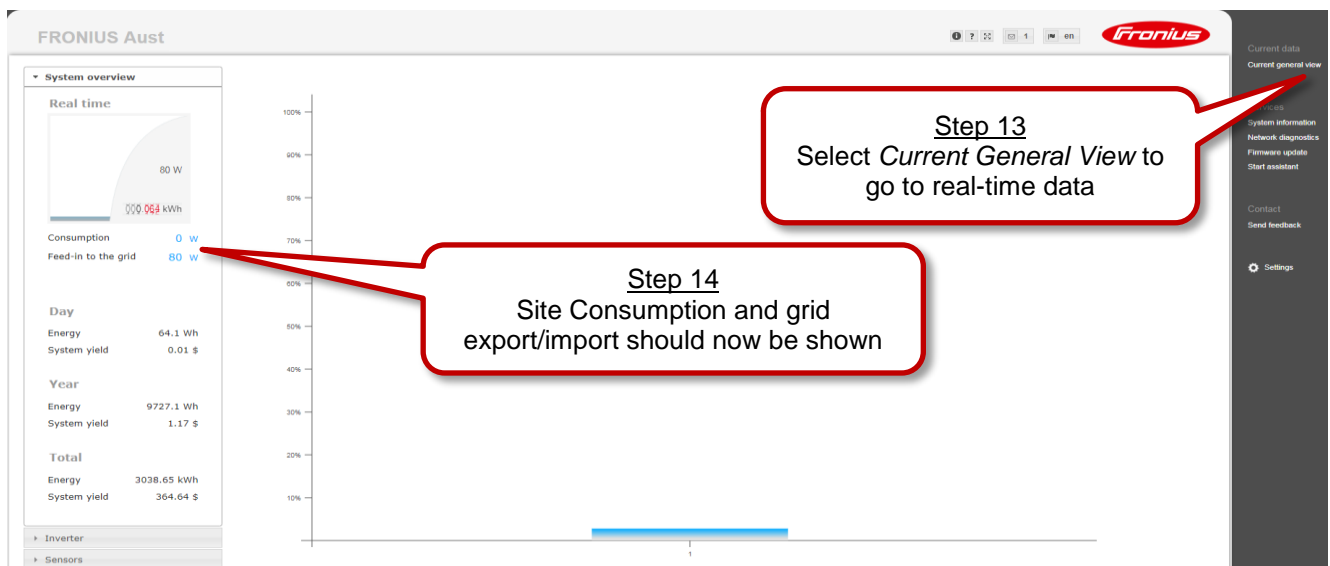

Step 13
Select *Current General View* to go to real-time data

Step 14
Site Consumption and grid export/import should now be shown

Category	Energy	System yield
Day	64.1 Wh	0.01 \$
Year	9727.1 Wh	1.17 \$
Total	3038.65 kWh	364.64 \$

2.2.2 Activating the Fronius Smart Meter in the Technician Wizard

The Technician Wizard can be accessed in two ways:

- Via the Wi-Fi Access Point:
 - Activate the Wi-Fi Access Point on the Datamanager card (inverter screen under Setup) or Datamanager Box 2.0
 - Connect your computer/tablet/smart phone to the **Fronius_240.XXXXXX** network
 - Open a web browser and go to <http://192.168.250.181>.
 - Alternatively you can use the Fronius SolarWeb App (Tablet/Smart Phone), open the Solar.web app and select *Settings*. Then select *PV Inverter Homepage* or *Your System Monitoring* depending on your device.
- Via the LAN Port:
 - Connect your computer to the Datamanager via LAN cable
 - Switch the Datamanager IP Switch to Position 'A'
 - Open a web browser and go to <http://169.254.0.180>

Once connected follow the below steps:



System monitoring

Welcome to the Fronius setup wizard.

You are just a few steps away from convenient system monitoring.

Step 1
Select *Technician Wizard* to begin

SOLAR.WEB WIZARD
Connect the system with the Fronius Solar.web and use our Apps for mobile devices.

TECHNICIAN WIZARD
System settings for feed-in limits, Power Control-functions and open interfaces!
! For qualified persons only !

System monitoring

General | Inverter | Service password

System name *

Yield

Feed-in tariff \$ (AUD) /kWh

Grid supply tariff /kWh

System time

Date / time * :

Set time automatically

Time zone settings

Time zone *



System monitoring en

General **Inverter** Service password

System name *

No	visible	Device type	Device name	PV[Wp]
1	<input checked="" type="checkbox"/>	Primo 3.0-1	* <input type="text" value="Primo 3.0-1 (1)"/>	* <input type="text" value="3000"/>

Step 3
Set the DC array Watt Peak (Wp) value for all inverters then select Forward

System monitoring en

Inverter **Service password** IO mapping

Please set a password! The Service password protects the system settings from unauthorized changes.

User name

Password * acceptable

Repeat password * identical

Important: Make a note of the service password as it's required to make any changes to the smart meter settings later on

Step 4
Set a service password to limit access. Minimum 8 characters with both numbers and letters. Then select Forward



System monitoring

Service password

Meter

Sign in

http://192.168.250.181

Your connection to this site is not private

Username: service

Password:

Sign in Cancel

Step 5
Login with username: *service* and the password created in Step 4

Back Forward

System monitoring

en

Service password

IO mapping

Meter

RS485

9	7	5	3	1	-	-	D-
8	6	4	2	0	+	+	D+

RS485

- can be used as an input or output
- can be used as an input
- pin already in use

PIN ASSIGNMENTS

- 0. IO control feedback
- 1. none
- 2. none
- 3. none
- 4. IO control 3
- 5. IO control 4
- 6. none

AUS - Demand Response Modes (DRM)

IO control

Load management

Back Forward

Step 6
Skip Forward over IO Mapping



System monitoring

en

IO mapping **Meter** Dynamic power

Primary meter:

Meter: None selected Settings

- None selected
- Fronius Smart Meter**
- S0 inverter 1

Secondary meter:

The secondary meters can be configured in the 'Settings Page' later.

List of configured meters:

Meter type	Location of the meter	Category	Name	Meter value	Settings	Delete

The secondary meters can be configured in the 'Settings Page' later.

[Download a schematic diagram of the wiring.](#)

Note: when connecting a Fronius Smart Meter, Modbus RTU is automatically disabled.

Back Forward

Step 7
Select *Fronius Smart Meter* from the dropdown box and then select *Settings*

Older software versions do not have the *List of Configured Meters* or *Secondary Meter*

System monitoring

en

IO mapping **Meter** Dynamic power

Primary meter:

Meter: Fronius Smart Meter Settings

Secondary meter:

The secondary meters can be configured in the 'Settings Page' later.

List of configured meters:

Meter type	Location of the meter	Category	Name	Meter value	Settings	Delete

Note

The meter has been activated and should provide data soon. Please wait a moment!

State: looking for the meter

Cancel

[Download a schematic diagram of the wiring.](#)

Note: when connecting a Fronius Smart Meter, Modbus RTU is automatically disabled.

Back Forward

Step 8
Leave this window open until the State changes to *OK* or *Timeout*



System monitoring

IO mapping **Meter** Dynamic power

Step 9
If State is *OK* then set meter location and select *OK*. Refer to Section 1.1 of this guide for explanation of locations

If the State is *Timeout* then retry the process. If it still times-out refer to troubleshooting steps in Section 4 of this guide

Note
State: **OK** Power: 5 W
Location of the meter: Feed-in point Consumption path
Modbus address: 1
Serial number: 15070170

Settings Delete
Forward

System monitoring

IO mapping **Meter** Dynamic power

Primary meter:
Meter: Fronius Smart Meter Settings

Secondary meter:
The secondary meters can be configured in the 'Settings Page' later.

List of configured meters:

Meter type	Location of the meter	Category	Name	Meter value	Settings
Fronius Smart Meter	Feed-in point	Primary meter		Consumption: 4 W	Settings

The secondary meters can be configured in the 'Settings Page' later.

Download a schematic diagram of the wiring.



Note: when connecting a Fronius Smart Meter, Modbus RTU is automatically disabled.

Back **Forward**

Older software versions do not have the *List of Configured Meters* or *Secondary Meter*

Step 10
Select *Forward*



System monitoring   en 

IO mapping Meter **Dynamic power**



Dynamic power reduction

Power limit: No limit limit for entire system

If an export limit needs to be set, please refer to our separate export limiting guide.

Step 11
Select *Forward*



Back Forward

System monitoring   en 

Welcome

You are just a few steps away from being online monitoring.

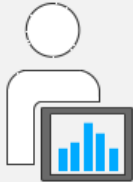
The Technician Wizard is now complete and the meter has been setup. Online monitoring can be setup via the Solar.Web Wizard

 SOLAR.WEB WIZARD  TECHNICIAN WIZARD

Connect the system with the Fronius Solar.web and use our Apps for mobile devices.

FURTHER SETTINGS

! For qualified persons only !

3. ACTIVATING NIGHT MODE* ON THE INVERTER DISPLAY

Night mode is required to be activated to log site consumption values overnight. To activate night mode complete the below steps on the inverter display:

- 1) Enter the *Setup* menu



- 2) Scroll down and enter *Display Settings*

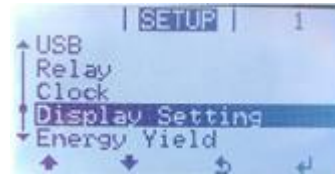

- 3) Scroll down and enter *Night Mode*

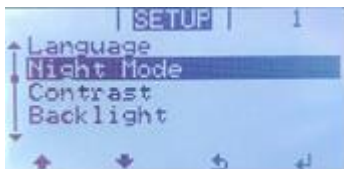

- 4) Set to *ON* and enter to save the setting



***Night mode**: Not applicable on Fronius Symo Hybrid inverters.



4. FRONIUS SMART METER TROUBLESHOOTING

4.1 – Timeout: meter not detected

If the Fronius Smart Meter is not being detected in the Technician wizard or PV Inverter homepage try the following steps in order. After each step try to activate the meter again.

- 1) Restart the Datamanager. Shutdown both AC and DC to the inverter to switch it off, and then power it back up. Reconnect to the Wi-Fi access point and attempt to activate the meter again.
- 2) Switch the position of the **Master – Slave switch** on the Datamanager Card from **Master to Slave**. Wait for 10 seconds and then switch it **back to Master** and then try activating the meter again. Please note: If this step is being followed, make sure that the W-Fi access point on the inverter is active and then your device should be connected to the Wi-Fi access point.
- 3) Check that the 120Ω resistor is installed correctly across the meter terminals as per the wiring diagrams in Section 2.1.
- 4) Confirm that the cable used between meter terminals and Datamanager 2.0 terminal block are properly terminated.
- 5) Confirm that the RS485 wiring between meter terminals and Datamanager 2.0 terminal block are correct as per the wiring diagrams in Section 2.2.
- 6) If cable is short enough, complete a continuity test on the cores used to ensure no breaks in the cable.
- 7) Update the Datamanager 2.0 software. After software update restart the Datamanager 2.0 as per Step 1 of this section. Refer to our update guide for more information:
https://www.fronius.com/~/downloads/Solar%20Energy/Technical%20Articles/SE_TEA_Quick_guide_How_to_update_Fronius_Datamanager_firmware_EN_AU.pdf

4.2 – Data is not accurate in Solar.web

- 1) Meter is set in the incorrect path compared to actual installation: Refer to Section 1.1 of this guide and correct as per the above set-up steps in 2.2.1 and 2.2.2.
- 2) Meter is installed in the wrong location in the switchboard: It must be installed after the Normal Supply Main switch and before the rest of the site loads including the Solar Supply Main Switch for feed in path. Refer to the single line diagrams in Section 1.1
- 3) If getting minimal load consumption values the meter may be in parallel with the Normal Supply Main Switch. Ensure they are in series or the meter will be mostly bypassed.

4.3 – Night consumption values are not logged in Solar.web

- 1) Turn on night mode as per Section 3 of this guide