

Operating manual

SUNNY TRIPOWER 15000TL / 20000TL / 25000TL

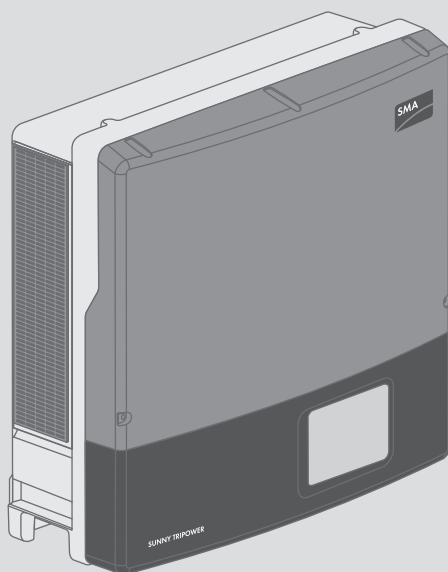

Legal Provisions

The information contained in these documents is the property of SMA Solar Technology AG. No part of this document may be reproduced, stored in a retrieval system, or transmitted, in any form or by any means, be it electronic, mechanical, photographic, magnetic or otherwise, without the prior written permission of SMA Solar Technology AG. Internal reproduction used solely for the purpose of product evaluation or other proper use is allowed and does not require prior approval.

SMA Solar Technology AG makes no representations or warranties, express or implied, with respect to this documentation or any of the equipment and/or software it may describe, including (with no limitation) any implied warranties of utility, merchantability, or fitness for any particular purpose. All such representations or warranties are expressly disclaimed. Neither SMA Solar Technology AG nor its distributors or dealers shall be liable for any indirect, incidental, or consequential damages under any circumstances.

The exclusion of implied warranties may not apply in all cases under some statutes, and thus the above exclusion may not apply.

Specifications are subject to change without notice. Every attempt has been made to make this document complete, accurate and up-to-date. Readers are cautioned, however, that product improvements and field usage experience may cause SMA Solar Technology AG to make changes to these specifications without advance notice, or per contract provisions in those cases where a supply agreement requires advance notice. SMA Solar Technology AG shall not be responsible for any damages, including indirect, incidental or consequential damages, caused by reliance on the material presented, including, but not limited to, omissions, typographical errors, arithmetical errors or listing errors in the content material.

SMA Warranty

You can download the current warranty conditions from the Internet at www.SMA-Solar.com.

Trademarks

All trademarks are recognized, even if not explicitly identified as such. Missing designations do not mean that a product or brand is not a registered trademark.

SMA Solar Technology AG

Sonnenallee 1

34266 Niestetal

Germany

Tel. +49 561 9522-0

Fax +49 561 9522-100

www.SMA.de

Email: info@SMA.de

Status: 7/22/2019

Copyright © 2019 SMA Solar Technology AG. All rights reserved.

Table of Contents

1	Information on this Document	5
1.1	Validity	5
1.2	Target Group	5
1.3	Content and Structure of this Document	5
1.4	Levels of Warning Messages	5
1.5	Symbols in the Document	6
1.6	Typographies in the Document.....	6
1.7	Designation in the document	6
1.8	Additional Information	7
2	Safety	8
2.1	Intended Use	8
2.2	IMPORTANT SAFETY INSTRUCTIONS.....	8
3	Scope of Delivery	13
4	Product Overview	14
4.1	Product Description	14
4.2	Symbols on the Product	15
4.3	Interfaces and Functions	16
4.4	LED Signals.....	18
5	Mounting.....	19
5.1	Requirements for Mounting	19
5.2	Mounting the Inverter.....	21
6	Electrical Connection	24
6.1	Overview of the Connection Area	24
6.1.1	View from Below.....	24
6.1.2	Interior View	25
6.2	AC Connection.....	26
6.2.1	Requirements for the AC Connection	26
6.2.2	Connecting the Inverter to the Utility Grid	27
6.2.3	Connecting Additional Grounding	29
6.3	DC Connection.....	30
6.3.1	Requirements for the DC Connection	30
6.3.2	Connecting the PV Array.....	30
6.4	Retrofitting the Surge Arrester Type II	32
7	Commissioning	33

7.1	Commissioning Procedure	33
7.2	Configuring the Country Data Set.....	33
7.3	Commissioning the Inverter.....	40
8	Configuration.....	43
8.1	Configuration Procedure.....	43
8.2	Integrating the Inverter into the Network.....	43
8.3	Changing Operating Parameters.....	44
8.4	Configuring the Modbus Function.....	44
8.5	Configuring Q on Demand 24/7	45
8.6	Reducing the Attenuation of Ripple Control Signals	46
8.7	Setting SMA OptiTrac Global Peak	46
9	Operation	48
9.1	Display Overview.....	48
9.2	Activating and Operating the Display	50
9.3	Changing the Display Language	50
9.4	Calling Up Display Messages of the Start-Up Phase	51
9.5	Updating the Firmware	51
10	Troubleshooting.....	54
10.1	Event Messages	54
10.2	Cleaning the Fans	64
10.2.1	Cleaning the Fan at the Bottom	64
10.2.2	Cleaning the Fan on the Left-Hand Side of the Enclosure.....	65
10.3	Checking the Function of the Fans	67
10.4	Checking the PV System for Ground Faults	68
10.5	Checking the Function of the Surge Arresters	71
10.6	Replacing the Surge Arrester.....	72
11	Disconnecting the Inverter from Voltage Sources	75
12	Procedure for Receiving a Replacement Device.....	78
13	Decommissioning the Inverter.....	82
14	Technical Data	84
15	Spare Parts and Accessories	89
16	Contact	90
17	EU Declaration of Conformity	92

1 Information on this Document

1.1 Validity

This document is valid for:

- STP 15000TL-30 (Sunny Tripower 15000TL)
- STP 17000TL-30 (Sunny Tripower 17000TL)
- STP 20000TL-30 (Sunny Tripower 20000TL)
- STP 25000TL-30 (Sunny Tripower 25000TL)

1.2 Target Group

This document is intended for qualified persons and end users. Only qualified persons are allowed to perform the activities marked in this document with a warning symbol and the caption "Qualified person". Tasks that do not require any particular qualification are not marked and can also be performed by end users. Qualified persons must have the following skills:

- Knowledge of how an inverter works and is operated
- Training in how to deal with the dangers and risks associated with installing, repairing and using electrical devices and installations
- Training in the installation and commissioning of electrical devices and installations
- Knowledge of all applicable laws, standards and directives
- Knowledge of and compliance with this document and all safety information

1.3 Content and Structure of this Document

This document describes the mounting, installation, commissioning, configuration, operation, troubleshooting and decommissioning of the product.

You will find the latest version of this document and further information on the product in PDF format and as eManual at www.SMA-Solar.com. You can also call up the eManual via the user interface of the product.

Illustrations in this document are reduced to the essential information and may deviate from the real product.

1.4 Levels of Warning Messages



The following levels of warning messages may occur when handling the product.

 DANGER
Indicates a hazardous situation which, if not avoided, will result in death or serious injury.
 WARNING
Indicates a hazardous situation which, if not avoided, could result in death or serious injury.
 CAUTION
Indicates a hazardous situation which, if not avoided, could result in minor or moderate injury.

NOTICE

Indicates a situation which, if not avoided, can result in property damage.

1.5 Symbols in the Document

Symbol	Explanation
	Information that is important for a specific topic or goal, but is not safety-relevant
<input type="checkbox"/>	Indicates a requirement for meeting a specific goal
<input checked="" type="checkbox"/>	Desired result
x	A problem that might occur
	Example
▲ QUALIFIED PERSON	Sections describing activities to be performed by qualified persons only

1.6 Typographies in the Document

Typography	Use	Example
bold	<ul style="list-style-type: none"> Messages Terminals Elements on a user interface Elements to be selected Elements to be entered 	<ul style="list-style-type: none"> Connect the insulated conductors to the terminals X703:1 to X703:6. Enter 10 in the field Minutes.
>	<ul style="list-style-type: none"> Connects several elements to be selected 	<ul style="list-style-type: none"> Select Settings > Date.
[Button] [Key]	<ul style="list-style-type: none"> Button or key to be selected or pressed 	<ul style="list-style-type: none"> Select [Enter].
#	<ul style="list-style-type: none"> Placeholder for variable components (e.g., parameter names) 	<ul style="list-style-type: none"> Parameter WcHz.Hz#

1.7 Designation in the document

Complete designation	Designation in this document
PV system	PV system
Sunny Tripower	Inverter, product

1.8 Additional Information

For more information, please go to www.SMA-Solar.com.

Title and information content	Type of information
"Application for SMA Grid Guard Code"	Form
"SMA GRID GUARD 10.0 - Grid management services through SMA Inverter"	Technical Information
"Efficiency and Derating" Efficiency and derating behavior of the SMA inverters	Technical Information
"Short-Circuit Currents" Information on short-circuit currents of SMA PV inverters	Technical Information
"Parameters and Measured Values" Overview of all inverter operating parameters and their configuration options	Technical Information
"SMA and SunSpec Modbus® Interface" Information on the Modbus interface	Technical Information
"Modbus® parameters and measured values" Device-specific register HTML file	Technical Information
"SMA Speedwire/Webconnect Data Module" Connection to the Speedwire/Webconnect data module	Installation manual
"Integrated Plant Control" Detailed explanation of the function and description for setting the function	Technical Information
"Leading Leakage Currents" Information on the Design of Transformerless Inverters	Technical Information

2 Safety

2.1 Intended Use

The Sunny Tripower is a transformerless PV inverter, with 2 MPP trackers, that converts the direct current of the PV array to grid-compliant, three-phase current and feeds it into the utility grid.

The product is suitable for indoor and outdoor use.

The product must only be operated with PV modules of protection class II in accordance with IEC 61730, application class A. The PV modules must be compatible with this product.

PV modules with a high capacity to ground must only be used if their coupling capacity does not exceed 3.5 μF (for information on how to calculate the coupling capacity, see the Technical Information "Leading Leakage Currents" at www.SMA-Solar.com).

All components must remain within their permitted operating ranges and their installation requirements at all times.

The product must only be used in countries for which it is approved or released by SMA Solar Technology AG and the grid operator.

The product is also approved for the Australian market and may be used in Australia. If DRM support is specified, the inverter may only be used in conjunction with a Demand Response Enabling Device (DRED). This ensures that the inverter implements the commands from the grid operator for active power limitation at all times. The inverter and the Demand Response Enabling Device (DRED) must be connected in the same network and the inverter Modbus interface must be activated and the TCP server set.

Use SMA products only in accordance with the information provided in the enclosed documentation and with the locally applicable laws, regulations, standards and directives. Any other application may cause personal injury or property damage.

Alterations to the SMA products, e.g., changes or modifications, are only permitted with the express written permission of SMA Solar Technology AG. Unauthorized alterations will void guarantee and warranty claims and in most cases terminate the operating license. SMA Solar Technology AG shall not be held liable for any damage caused by such changes.

Any use of the product other than that described in the Intended Use section does not qualify as the intended use.

The enclosed documentation is an integral part of this product. Keep the documentation in a convenient, dry place for future reference and observe all instructions contained therein.

This document does not replace and is not intended to replace any local, state, provincial, federal or national laws, regulations or codes applicable to the installation, electrical safety and use of the product. SMA Solar Technology AG assumes no responsibility for the compliance or non-compliance with such laws or codes in connection with the installation of the product.

The type label must remain permanently attached to the product.

2.2 IMPORTANT SAFETY INSTRUCTIONS

SAVE THESE INSTRUCTIONS

This section contains safety information that must be observed at all times when working.

The product has been designed and tested in accordance with international safety requirements. As with all electrical or electrical devices, there are residual risks despite careful construction. To prevent personal injury and property damage and to ensure long-term operation of the product, read this section carefully and observe all safety information at all times.

 **DANGER**

Danger to life due to electric shock when live components or DC cables are touched

When exposed to light, the PV modules generate high DC voltage which is present in the DC cables. Touching live DC cables results in death or lethal injuries due to electric shock.

- Do not touch non-insulated parts or cables.
- Disconnect the product from voltage sources and make sure it cannot be reconnected before working on the device.
- Wear suitable personal protective equipment for all work on the product.

 **DANGER**

Danger to life due to electric shock from touching an ungrounded PV module or array frame

Touching ungrounded PV modules or array frames results in death or lethal injuries due to electric shock.

- Connect and ground the frame of the PV modules, the array frame and the electrically conductive surfaces so that there is continuous conduction. Observe the applicable local regulations.

 **DANGER**

Danger to life due to electric shock when touching live system components in case of a ground fault

If a ground fault occurs, parts of the system may still be live. Touching live parts and cables results in death or lethal injuries due to electric shock.

- Disconnect the product from voltage sources and make sure it cannot be reconnected before working on the device.
- Touch the cables of the PV array on the insulation only.
- Do not touch any parts of the substructure or frame of the PV array.
- Do not connect PV strings with ground faults to the inverter.
- Ensure that no voltage is present and wait five minutes before touching any parts of the PV system or the product.

⚠ WARNING**Danger to life due to fire or explosion**

In rare cases, an explosive gas mixture can be generated inside the inverter under fault conditions. In this state, switching operations can cause a fire inside the inverter or explosion. Death or lethal injuries due to hot or flying debris can result.

- In the event of a fault, do not perform any direct actions on the inverter.
- Ensure that unauthorized persons have no access to the inverter.
- Disconnect the AC circuit breaker, or keep it disconnected in case it has already tripped, and secure it against reconnection.
- Only perform work on the inverter (e.g., troubleshooting, repair work) when wearing personal protective equipment for handling of hazardous substances (e.g., safety gloves, eye and face protection, respiratory protection).

⚠ WARNING**Risk of injury due to toxic substances, gases and dusts.**

In rare cases, damages to electronic components can result in the formation of toxic substances, gases or dusts inside the inverter. Touching toxic substances and inhaling toxic gases and dusts can cause skin irritation, burns or poisoning, trouble breathing and nausea.

- Only perform work on the inverter (e.g., troubleshooting, repair work) when wearing personal protective equipment for handling of hazardous substances (e.g., safety gloves, eye and face protection, respiratory protection).
- Ensure that unauthorized persons have no access to the inverter.

⚠ WARNING**Danger to life due to electric shock from destruction of the measuring device due to overvoltage**

Overvoltage can damage a measuring device and result in voltage being present in the enclosure of the measuring device. Touching the live enclosure of the measuring device results in death or lethal injuries due to electric shock.

- Only use measuring devices with a DC input voltage range of 1000 V or higher.

⚠ CAUTION**Risk of burns due to hot enclosure parts**

Some parts of the enclosure can get hot during operation.

- Do not touch any parts other than the lower enclosure lid of the inverter during operation.

NOTICE**Damage to the enclosure seal in subfreezing conditions**

If you open the product when temperatures are below freezing, the enclosure seals can be damaged. Moisture can penetrate the product and damage it.

- Only open the product if the ambient temperature is not below -5°C .
- If a layer of ice has formed on the enclosure seal when temperatures are below freezing, remove it prior to opening the product (e.g. by melting the ice with warm air).

NOTICE**Damage to the product due to sand, dust and moisture ingress**

Sand, dust and moisture penetration can damage the product and impair its functionality.

- Only open the product if the humidity is within the thresholds and the environment is free of sand and dust.
- Do not open the product during a dust storm or precipitation.
- Close tightly all enclosure openings.

NOTICE**Damage due to cleaning agents**

The use of cleaning agents may cause damage to the product and its components.

- Clean the product and all its components only with a cloth moistened with clear water.

NOTICE**Damage to the inverter due to electrostatic discharge**

Touching electronic components can cause damage to or destroy the inverter through electrostatic discharge.

- Ground yourself before touching any component.

i **The inverter supports different firmware versions to fulfill different grid-connection requirements within the EU.**

With the firmware version $\leq 2.99.99.R$, the inverter fulfills the grid-connection requirements valid until April 26, 2019 within the EU. Grid-connection requirements outside the EU are not affected and remain valid. With the firmware version $\geq 3.00.00.R$, the inverter fulfills the European grid-connection requirements in accordance with Regulation (EU) 2016/631 for establishing a network code (also known as RfG), valid from April 26 2019 within the EU. The inverter can be equipped ex-factory with the firmware version $\geq 3.00.00.R$. This can be identified by the imprints "SMA Grid Guard 10.0" and "RfG Firmware for EU countries" on the box label. If no imprints can be found on the box label, the inverter is equipped with the firmware version $\leq 2.99.99.R$.

- Ensure that the inverter is equipped with a firmware version that fulfills the local grid-connection requirements.

i **Change to the names and units of grid parameters to comply with the grid-connection requirements in accordance with Regulation (EU) 2016/631 (valid from April 27, 2019)**

To comply with the EU grid-connection requirements (valid from April 27, 2019) the names and units of grid parameters were changed. The change is valid from firmware version $\geq 3.00.00.R$. Names and units of grid parameters for inverters with firmware version $\leq 2.99.99.R$ are not affected by this change and remain valid.

3 Scope of Delivery

Check the scope of delivery for completeness and any externally visible damage. Contact your distributor if the scope of delivery is incomplete or damaged.

The delivery may contain parts that are not required for the installation of this inverter.

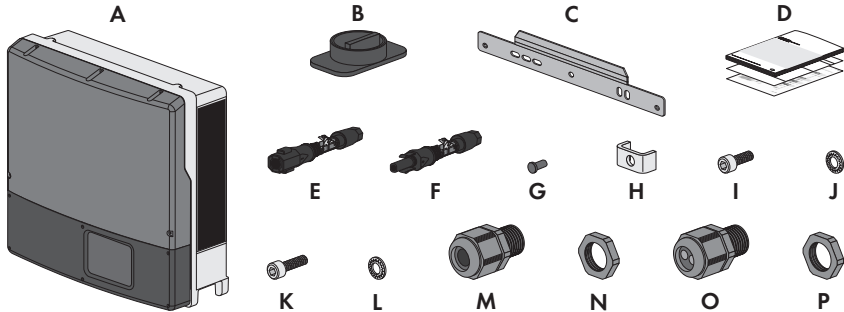

Figure 1: Components included in the scope of delivery

Position	Quantity	Designation
A	1	Inverter
B	1	DC Load-Break Switch
C	1	Wall mounting bracket
D	1	Quick reference guide, supplementary sheet with default settings, installation manual of the DC connector
E	6	Negative DC connector
F	6	Positive DC connector
G	12	Sealing plug
H	1	Clamping bracket
I	1	Cylindrical screw M6 x 16
K	1	Conical spring washer M6
L	2	Cylindrical screw M5 x 20*
M	2	Conical spring washer M5*
P	1	AC cable gland
Q	1	Counter nut

* Spare part for the enclosure lid

4 Product Overview

4.1 Product Description

The Sunny Tripower is a transformerless PV inverter, with 2 MPP trackers, that converts the direct current of the PV array to grid-compliant, three-phase current and feeds it into the utility grid.

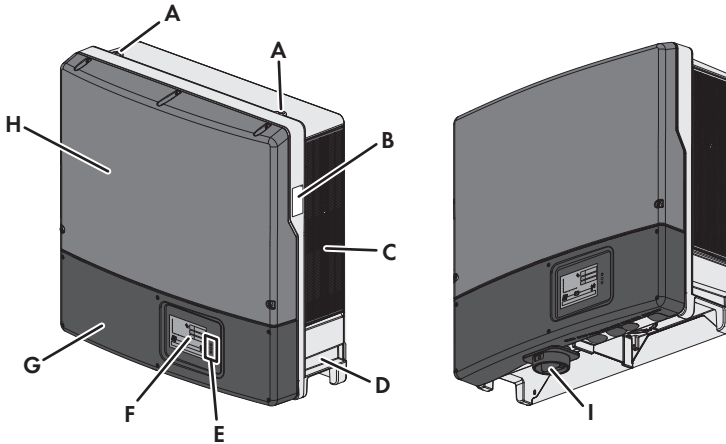

















Figure 2: Design of the Sunny Tripower

Position	Designation
A	Thread for screwing in two eye bolts for transport
B	Type label The type label uniquely identifies the inverter. You will require the information on the type label to use the product safely and when seeking customer support from the SMA Service Line. You will find the following information on the type label: <ul style="list-style-type: none"> • Device type (Model) • Serial number (Serial No.) • Date of manufacture • Device-specific characteristics
C	Ventilation grid
D	Recessed grip
E	LEDs The LEDs indicate the operating state of the inverter (see Section 4.4 "LED Signals", page 18).

Position	Designation
F	Display (optional) The display shows the current operating data and events or errors (see Section 10.1 "Event Messages", page 54).
G	Lower enclosure lid
H	Upper enclosure lid
I	DC Load-Break Switch The inverter is equipped with a DC load-break switch. If the DC load-break switch is set to the position I , it establishes a conductive connection between the PV array and the inverter. Setting the DC load-break switch to the O position interrupts the DC electric circuit and completely disconnects the PV array from the inverter. Disconnection takes place at all poles.

4.2 Symbols on the Product

Symbol	Explanation
	Beware of a danger zone This symbol indicates that the product must be additionally grounded if additional grounding or equipotential bonding is required at the installation site.
	Beware of electrical voltage The product operates at high voltages.
	Beware of hot surface The product can get hot during operation.
	Danger to life due to high voltages in the inverter; observe a waiting time of 5 minutes High voltages that can cause lethal electric shocks are present in the live components of the inverter. Prior to performing any work on the inverter, disconnect it from all voltage sources as described in this document.
	Observe the documentation Observe all documentation supplied with the product.
	Observe the documentation Together with the red LED, this symbol indicates an error.

Symbol	Explanation
	Inverter Together with the green LED, this symbol indicates the operating state of the inverter.
	No function
	Three-phase alternating current with neutral conductor
	Direct current
	The product is has no galvanic isolation.
	WEEE designation Do not dispose of the product together with the household waste but in accordance with the disposal regulations for electronic waste applicable at the installation site.
	The product is suitable for outdoor installation.
IP65	Degree of protection IP65 The product is protected against the penetration of dust and water that is directed as a jet against the enclosure from all directions.
	CE marking The product complies with the requirements of the applicable EU directives.
	RCM (Regulatory Compliance Mark) The product complies with the requirements of the applicable Australian standards.
	The product complies with the Moroccan safety and EMC requirements for electronic products.

4.3 Interfaces and Functions

The inverter can be equipped or retrofitted with the following interfaces and functions:

SMA Speedwire/Webconnect

The inverter is equipped with SMA Speedwire/Webconnect as standard. SMA Speedwire/Webconnect is a type of communication based on the Ethernet standard. This enables inverter-optimized 10/100 Mbit data transmission between Speedwire devices in PV systems and the software Sunny Explorer. The Webconnect function enables direct data transmission between the inverters of a small-scale system and the Internet portal Sunny Portal without any additional communication device and for a maximum of 4 inverters per Sunny Portal system. In large-scale PV power plants, data transmission to the Internet portal Sunny Portal is carried out via the SMA Cluster Controller. You can access your Sunny Portal system from any computer with an Internet connection.

Webconnect enables - for PV systems operated in Italy - the connection or disconnection of the inverter to or from the utility grid and the specifying of the frequency limits to be used via IEC61850-GOOSE messages.

Modbus

The product is equipped with a Modbus interface. The Modbus interface is deactivated by default and must be configured as needed.

The Modbus interface of the supported SMA products is designed for industrial use - via SCADA systems, for example - and has the following tasks:

- Remote query of measured values
- Remote setting of operating parameters
- Setpoint specifications for system control

RS485 Interface

The inverter can communicate via cables with special SMA communication products via the RS485 interface (information on supported SMA products at www.SMA-Solar.com). The RS485 interface can be retrofitted and can be used in place of the SMA Speedwire/Webconnect interface in the inverter.

Grid management services

The product is equipped with service functions for grid management.

Depending on the requirements of the grid operator, you can activate and configure the functions (e.g. active power limitation) via operating parameters.

SMA Power Control Module

The SMA Power Control Module enables the inverter to implement grid management services and is equipped with an additional multifunction relay (for information on installation and configuration, see the installation manual of the SMA Power Control Module). The SMA Power Control Module can be retrofitted.

Multifunction Relay

You can configure the multifunction relay for various operating modes. The multifunction relay is used, for example, to switch fault indicators on or off (for information on installation and configuration, see the installation manual of the multifunction relay). The multifunction relay can be retrofitted.

SMA OptiTrac Global Peak

SMA OptiTrac Global Peak is an advancement of SMA OptiTrac and allows the operating point of the inverter to follow the optimal operating point of the PV array (MPP) precisely at all times. In addition, with the aid of SMA OptiTrac Global Peak, the inverter detects several maximum power points in the available operating range, such as may occur particularly with partially shaded strings. SMA OptiTrac Global Peak is enabled by default.

Surge Arrester Type II

Surge arresters limit dangerous overvoltages. Surge arresters of type II can be retrofitted.

Q on Demand 24/7

The inverter can supply reactive power by means of Q on Demand 24/7 covering the entire unit circle around the clock.

Integrated Plant Control

The inverter can display the Q(V) characteristic curve specified by the grid operator by means of Integrated Plant Control without measuring on the grid-connection point. The inverter can automatically compensate equipment installed between the inverter and the grid-connection point after having activated the function (for information on the system configuration refer to the Technical Information "Integrated Plant Control" at www.SMA-Solar.com).

SMA Smart Connected

SMA Smart Connected is the free monitoring of the inverter via the SMA Sunny Portal. Thanks to SMA Smart Connected, the PV system operator and qualified person will be informed automatically and proactively about inverter events that occur.

SMA Smart Connected is activated during registration in Sunny Portal. In order to use SMA Smart Connected, it is necessary that the inverter is permanently connected to Sunny Portal and the data of the PV system operator and qualified person is stored in Sunny Portal and up-to-date.

4.4 LED Signals

The LEDs indicate the operating state of the inverter.

LED	Status	Explanation
Green LED	glowing	Feed-in operation If an event occurs during feed-in operation, an event message will be shown in the communication product (see Section 10.1, page 54).
	flashing	The conditions for feed-in operation are not yet met. As soon as the conditions are met, the inverter will start feed-in operation.
Red LED	glowing	Error An error has occurred. The error must be rectified by a qualified person (see Section 10.1, page 54).
Blue LED	-	No function

5 Mounting

5.1 Requirements for Mounting

Requirements for the Mounting Location:

⚠ WARNING

Danger to life due to fire or explosion

Despite careful construction, electrical devices can cause fires.

- Do not mount the product in areas containing highly flammable materials or gases.
 - Do not mount the product in potentially explosive atmospheres.
- Do not mount the inverter on a pillar.
 - A solid support surface must be available (e.g., concrete or masonry). When mounted on drywall or similar materials, the product emits audible vibrations during operation which could be perceived as annoying.
 - The mounting location must be inaccessible to children.
 - The mounting location must be suitable for the weight and dimensions of the product (see Section 14 "Technical Data", page 84).
 - The mounting location must not be exposed to direct solar irradiation. If the product is exposed to direct solar irradiation, the exterior plastic parts might age prematurely and overheating might occur. When becoming too hot, the product reduces its power output to avoid overheating.
 - The mounting location should be freely and safely accessible at all times without the need for any auxiliary equipment (such as scaffolding or lifting platforms). Non-fulfillment of these criteria may restrict servicing.
 - All ambient conditions must be met (see Section 14, page 84).
 - To ensure optimum operation, the ambient temperature should be between -25°C and 40°C .

Permitted and prohibited mounting positions:

- The product may only be mounted in a permitted position. This will ensure that no moisture can penetrate the product.
- The product should be mounted such that the LED signals can be read off without difficulty.

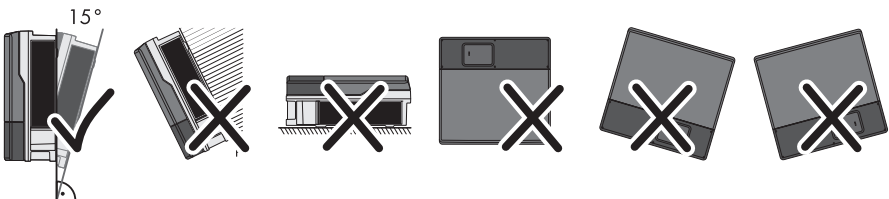

Figure 3: Permitted and prohibited mounting positions

Dimensions for mounting:

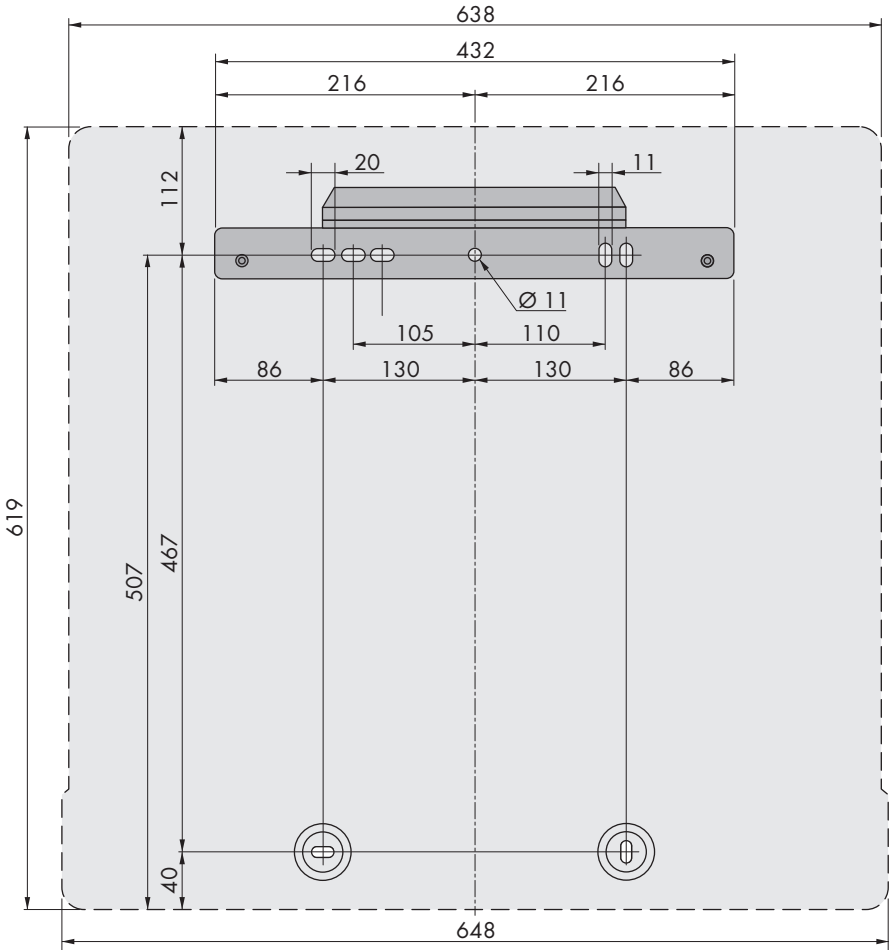

Figure 4: Position of the anchoring points(Dimensions in mm)

Recommended Clearances:

If you maintain the recommended clearances, adequate heat dissipation will be ensured. Thus, you will prevent power reduction due to excessive temperature.

- Maintain the recommended clearances to walls as well as to other inverters or objects.
- If multiple inverters are mounted in areas with high ambient temperatures, increase the clearances between the inverters and ensure sufficient fresh-air supply.

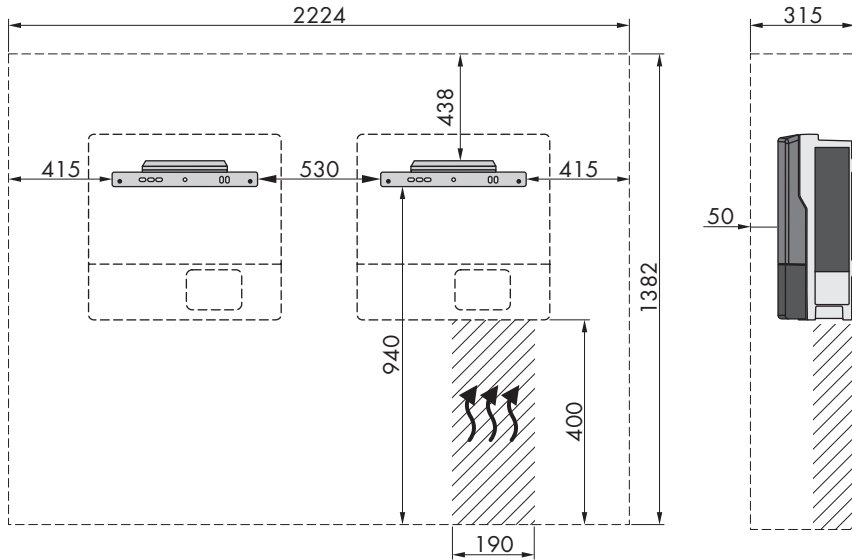

Figure 5: Recommended clearances(Dimensions in mm)

5.2 Mounting the Inverter

⚠ QUALIFIED PERSON

Additionally required mounting material (not included in the scope of delivery):

- At least two screws suitable for the support surface (diameter: 10 mm at maximum)
- At least two washers that are suitable for the screws (diameter: 30 mm at maximum)
- If necessary, two screw anchors suitable for the support surface and the screws
- For transporting the inverter with a crane: two eye bolts suitable for the weight of the inverter (size: M10)
- To secure the inverter from being lifted off: two screws suitable for the support surface, two washers suitable for the screws and - depending on the support surface - two screw anchors suitable for the support surface and the screws

⚠ CAUTION

Risk of injury when lifting the inverter, or if it is dropped

The inverter weighs 61 kg. There is risk of injury if the inverter is lifted incorrectly or dropped while being transported or when attaching it to or removing it from the wall mounting bracket.

- Transport the inverter always as described below.

⚠ CAUTION**Risk of burns due to hot enclosure parts**

Some parts of the enclosure can get hot during operation.

- Mount the inverter in such a way that it cannot be touched inadvertently during operation.

Procedure:

1.

⚠ CAUTION**Risk of injury due to damaged cables**

There may be power cables or other supply lines (e.g. gas or water) routed in the wall.

- Ensure that no lines are laid in the wall which could be damaged when drilling holes.

- Align the wall mounting bracket horizontally on the wall and use it to mark the position of the drill holes. Use at least one hole on the right-hand and left-hand side in the wall mounting bracket.
- If the inverter is to be secured from being lifted off of the wall mounting bracket, mark the position of the drill holes for the screw that attaches the inverter to the wall mounting bracket. Observe the dimensions of the two anchoring points at the bottom of the inverter rear panel.
- Set the wall mounting bracket aside and drill the marked holes.
- Insert screw anchors into the drill holes if the support surface requires them.
- Secure the wall mounting bracket horizontally using screws and washers.
- Hook the inverter into the wall mounting bracket.

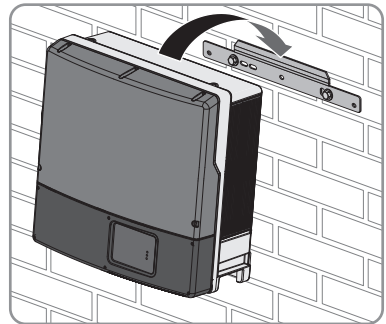

- If the inverter has been transported with a crane, remove the eye bolts from the threads on the top of the inverter and reinsert the filler plugs.
- Remove all six screws from the lower enclosure lid using an Allen key (AF 3).

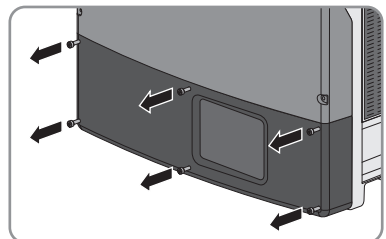

10. Flip the lower enclosure lid up and remove it.

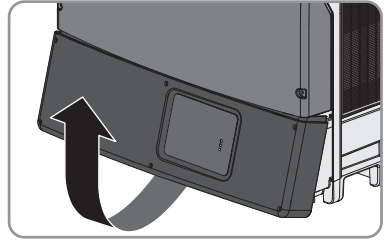

11. In order to secure the inverter from being lifted off the wall accidentally, attach it to the wall with suitable mounting material. Use both of the lower drill holes on the rear panel of the inverter.

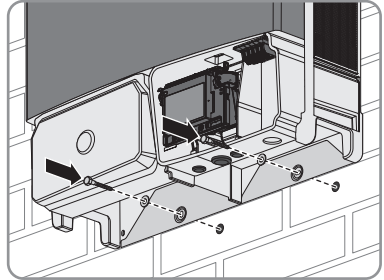

12. Ensure that the inverter is securely in place.

6 Electrical Connection

6.1 Overview of the Connection Area

6.1.1 View from Below

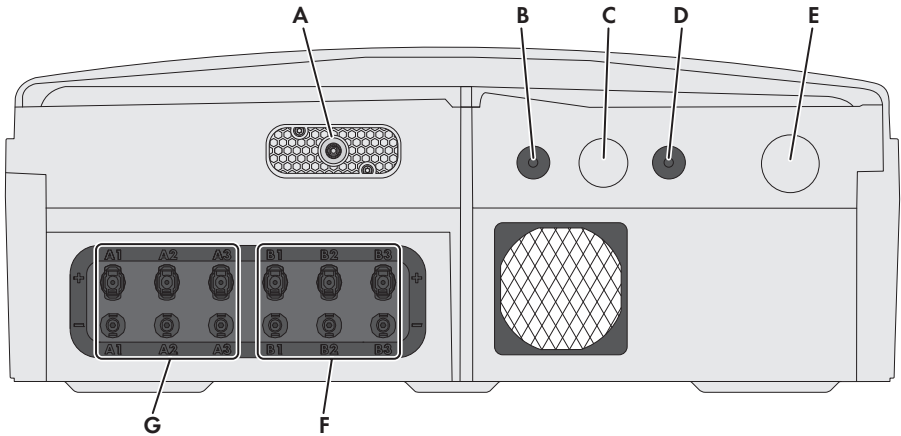

Figure 6: Enclosure openings at the bottom of the inverter

Position	Designation
A	Pin connector for the DC load-break switch
B	Enclosure opening M20 with filler plug for the connection cable of the multi-function relay or SMA Power Control Module
C	Enclosure opening M32 with filler plug for the data cables or network cables
D	Enclosure opening M20 with filler plug for the data cables or network cables
E	Enclosure opening for the AC connection
F	Positive and negative DC connectors, input B
G	Positive and negative DC connectors, input A

6.1.2 Interior View

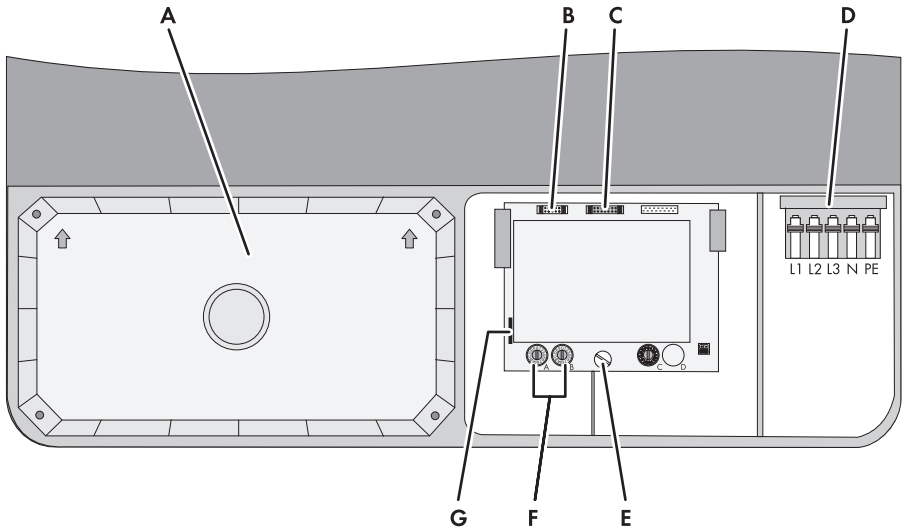

Figure 7: Connection areas in the interior of the inverter

Position	Designation
A	DC protective cover
B	Pin connector for connecting the multifunction relay or the SMA Power Control Module
C	Pin connector for connecting the communication interface
D	Connecting terminal plate for connecting the AC cable
E	Screw to release and attach the communication board
F	Rotary switch A and B for setting the country data set
G	Slot for the SD memory card (for service purposes)

6.2 AC Connection

6.2.1 Requirements for the AC Connection

Cable requirements:

- The conductors must consist of copper.
- External diameter: 14 mm to 25 mm
- Conductor cross-section: 6 mm² to 16 mm²
- Maximum conductor cross-section with bootlace ferrule: 10 mm²
- Insulation stripping length: 12 mm
- The cable must be dimensioned in accordance with the local and national directives for the dimensioning of cables. The requirements for the minimum wire size derive from these directives. Examples of factors influencing cable dimensioning are: nominal AC current, type of cable, routing method, cable bundling, ambient temperature and maximum desired line losses (for calculation of line losses, see the design software "Sunny Design" from software version 2.0 at www.SMA-Solar.com).

Load-break switch and cable protection:

NOTICE

Damage to the inverter due to the use of screw-type fuses as load-break switches

Screw-type fuses (e.g. DIAZED fuse or NEOZED fuse) are not load-break switches.

- Do not use screw-type fuses as load-break switches.
 - Use a load-break switch or circuit breaker as a load disconnection unit (for information and design examples, see the Technical Information "Circuit Breaker" at www.SMA-Solar.com).
- In PV systems with multiple inverters, protect each inverter with a separate three-phase circuit breaker. Make sure to observe the maximum permissible fuse protection (see Section 14 "Technical Data", page 84). This will prevent residual voltage from being present at the corresponding cable after disconnection.
 - Loads installed between the inverter and the circuit breaker must be fused separately.

Residual-current monitoring unit:

- If an external residual-current device is required, install a residual-current device which trips at a residual current of 100 mA or higher (for details on selecting a residual-current device, see the Technical Information "Criteria for Selecting a Residual-Current Device" at www.SMA-Solar.com).

Overvoltage category:

The inverter can be used in grids of overvoltage category III or lower in accordance with IEC 60664-1. That means that the inverter can be permanently connected to the grid-connection point of a building. In case of installations with long outdoor cabling routes, additional measures to reduce overvoltage category IV to overvoltage category III are required (see the Technical Information "Overvoltage Protection" at www.SMA-Solar.com).

Additional grounding:**i Safety in accordance with IEC 62109**

The inverter is not equipped with a grounding conductor monitoring device. In order to guarantee safety in accordance with IEC 62109, you must take one of the following measures:

- Connect a grounding conductor made of copper wire with a cross-section of at least 10 mm² to the connecting terminal plate for the AC cable.
- Connect additional grounding with the same cross-section as the connected grounding conductor to the connecting terminal plate for the AC cable (see Section 6.2.3 "Connecting Additional Grounding", page 29). This prevents touch current if the grounding conductor at the connecting terminal plate for the AC cable fails.

i Connection of additional grounding

In some countries, additional grounding is generally required. In each case, observe the locally applicable regulations.

- If additional grounding is required, connect an additional grounding that has at least the same cross-section as the connected grounding conductor to the connecting terminal plate for the AC cable (see Section 6.2.3, page 29). This prevents touch current if the grounding conductor at the connecting terminal plate for the AC cable fails.

6.2.2 Connecting the Inverter to the Utility Grid**⚠ QUALIFIED PERSON****Requirements:**

- The connection requirements of the grid operator must be met.
- The grid voltage must be in the permissible range. The exact operating range of the inverter is specified in the operating parameters.

Procedure:

1. Disconnect the circuit breaker from all three line conductors and secure against reconnection.
2. If the lower enclosure lid is mounted, loosen all screws of the lower enclosure lid using an Allen key (AF 3) and lift the enclosure lid from below and remove it.
3. Remove the adhesive tape from the enclosure opening for the AC cable.

4. Insert the cable gland from the outside into the enclosure opening and tighten it from the inside with the counter nut.

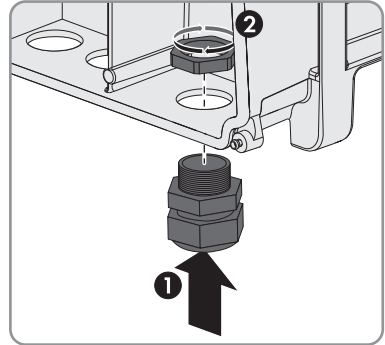

5. Route the AC cable into the inverter through the cable gland. If necessary, slightly loosen the swivel nut of the cable gland.
6. Dismantle the AC cable.
7. Shorten L1, L2, L3 and N by 5 mm each so that the grounding conductor is 5 mm longer.
8. Strip off the insulation of L1, L2, L3, N and PE by 12 mm.
9. Push the safety levers of the AC terminal block right up to the stop.

10.

⚠ CAUTION

Risk of fire if two conductors are connected to one terminal

If you connect two conductors to a terminal, a fire can occur due to a bad electrical connection.

- Never connect more than one conductor per terminal.

11.

⚠ CAUTION

Danger of crushing when locking levers snap shut

The locking levers close by snapping down fast and hard.

- Press the locking levers of the terminal block for the AC cable down with your thumb only.
- Do not grip the entire terminal block for the AC cable.
- Do not place your fingers under the locking levers.

12. Connect PE, N, L1, L2 and L3 according to the labeling to the terminal block for the AC cable and push the safety levers down. The direction of the rotating magnetic field of L1, L2 and L3 is not relevant.
13. Make sure that all conductors are securely in place.

14. Tighten the swivel nut of the cable gland.

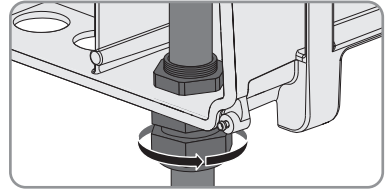

6.2.3 Connecting Additional Grounding

⚠ QUALIFIED PERSON

If additional grounding or equipotential bonding is required locally, you can connect additional grounding to the inverter. This prevents touch current if the grounding conductor at the terminal for the AC cable fails. The required clamping bracket, the screw and the conical spring washer are part of the scope of delivery of the inverter.

Cable requirements:

i Use of fine-stranded conductors

You can use an inflexible or a flexible, fine-stranded conductor.

- When using a fine-stranded conductor, it has to be double crimped by a ring terminal lug. Make sure that no insulated conductor is visible when pulling or bending. This will ensure sufficient strain relief by means of the ring terminal lug.

Grounding cable cross-section: max. 16 mm²

Procedure:

1. Strip the grounding cable insulation.
2. Lead the clamping bracket over the grounding cable. Arrange the grounding cable on the left-hand side.

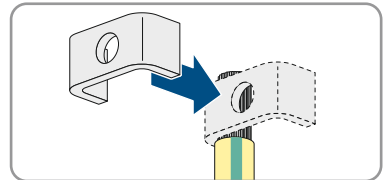

3. Screw the clamping bracket tight using the M6x16 cylindrical screw and the conical spring washer M6 (torque: 6 Nm). The teeth of the conical spring washer must face the clamping bracket.

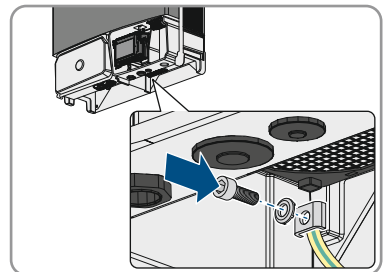

6.3 DC Connection

6.3.1 Requirements for the DC Connection

Requirements for the PV modules per input:

- All PV modules should be of the same type.
- All PV modules should be aligned and tilted identically.
- On the coldest day based on statistical records, the open-circuit voltage of the PV array must never exceed the maximum input voltage of the inverter.
- The maximum input current per string must be maintained and must not exceed the through-fault current of the DC connectors (see Section 14 "Technical Data", page 84).
- The thresholds for the input voltage and the input current of the inverter must be adhered to (see Section 14 "Technical Data", page 84).
- The positive connection cables of the PV modules must be fitted with the positive DC connectors (for information on assembling DC connectors, see the DC connector installation manual).
- The negative connection cables of the PV modules must be fitted with the negative DC connectors (for information on assembling DC connectors, see the DC connector installation manual).

i Use of Y adapters for parallel connection of strings

The Y adapters must not be used to interrupt the DC circuit.

- Do not use the Y adapters in the immediate vicinity of the inverter. The adapters must not be visible or freely accessible.
- In order to interrupt the DC circuit, always disconnect the inverter as described in this document (see Section 11, page 75).

6.3.2 Connecting the PV Array

⚠ QUALIFIED PERSON

NOTICE

Damage to the inverter due to ground fault on DC side during operation

Due to the transformerless topology of the product, the occurrence of ground faults on DC side during operation can lead to irreparable damage. Damages to the product due to a faulty or damaged DC installation are not covered by warranty. The product is equipped with a protective device that checks whether a ground fault is present during the starting sequence. The product is not protected during operation.

- Ensure that the DC installation is carried out correctly and no ground fault occurs during operation.

NOTICE**Destruction of the inverter due to overvoltage**

If the open-circuit voltage of the PV modules exceeds the maximum input voltage of the inverter, the inverter can be destroyed due to overvoltage.

- If the open-circuit voltage of the PV modules exceeds the maximum input voltage of the inverter, do not connect any strings to the inverter and check the design of the PV system.

⚠ WARNING**Danger to life due to electric shock from destruction of the measuring device due to overvoltage**

Overvoltage can damage a measuring device and result in voltage being present in the enclosure of the measuring device. Touching the live enclosure of the measuring device results in death or lethal injuries due to electric shock.

- Only use measuring devices with a DC input voltage range of 1000 V or higher.

NOTICE**Damage to the DC connectors due to the use of contact cleaner of other cleaning agents**

Some contact cleaners or other cleaning agents may contain substances that decompose the plastic of the DC connectors.

- Do not use contact cleaners or other cleaning agents for cleaning the DC connectors.

Procedure:

1. Ensure that the circuit breaker is switched off from all three line conductors and that it cannot be reconnected.
2. Ensure that there is no ground fault in the PV array.
3. Check whether the DC connectors have the correct polarity.

If the DC connector is equipped with a DC cable of the wrong polarity, the DC connector must be configured again. The DC cable must always have the same polarity as the DC connector.

4. Ensure that the open-circuit voltage of the PV array does not exceed the maximum input voltage of the inverter.
5. Connect the assembled DC connectors to the inverter.
 - ☑ The DC connectors snap into place.
6. For unused DC connectors, push down the clamping bracket and push the swivel nut up to the thread.
7. Insert the sealing plug into the DC connector.

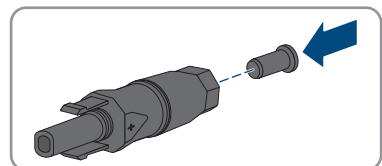

8. Insert the DC connectors with sealing plugs into the corresponding DC inputs on the inverter.

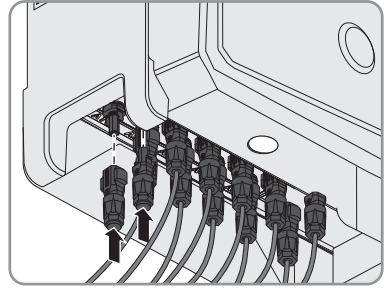

- ☑ The DC connectors snap into place.

9. Ensure that the DC connectors with sealing plugs are securely in place.

6.4 Retrofitting the Surge Arrester Type II

⚠ QUALIFIED PERSON

The inverter is equipped ex works with surge arresters or it can be retrofitted (see Section 1.5 "Spare Parts and Accessories", page 89).

1.

⚠ DANGER

Danger to life due to high voltages

- Disconnect the inverter from all voltage sources (see Section 1.1, page 75).
- Wait 20 minutes before you remove the DC protective cover to allow residual voltages to discharge.

2. Release the screws on the DC protective cover using an Allen key (AF 3), lift the DC protective cover upwards from below and remove it.

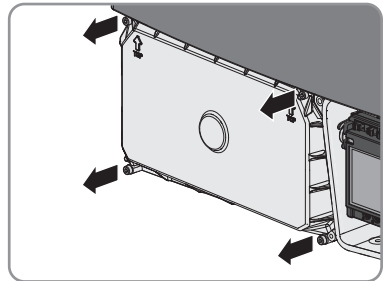

3. Plug the new surge arresters into the designated slots until they lock into place with the locking tabs. The inspection window must be located on the right-hand side.

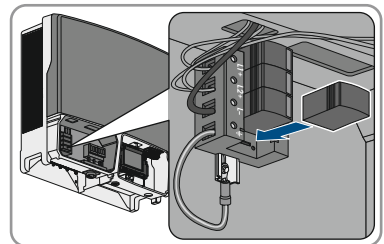

4. Position the DC protective cover at the upper edge, flip down and tighten it (torque: 3.5 Nm).

7 Commissioning

7.1 Commissioning Procedure

QUALIFIED PERSON

Before you can commission the inverter, you must check various settings and make changes if necessary. This section describes the procedure and gives an overview of the steps, which must always be performed in the prescribed sequence.

Procedure	See
1. Connection to the SMA Speedwire/Webconnect data module	Installation manual of the SMA Speedwire/Webconnect data module
2. Check which country data set the inverter is set to.	Supplementary sheet with the default settings, type label or display
3. If the country data set is not set correctly for your country or your purpose, adjust to the required country data set.	Section 7.2, page 33
4. Commission the inverter.	Section 7.3, page 40

7.2 Configuring the Country Data Set

QUALIFIED PERSON

Set the country data set appropriate for your country or purpose within the first ten feed-in hours via the rotary switches in the inverter. After the first ten feed-in hours, the country data set can only be changed by means of a communication product.

The country data set must be set correctly.

If you select a country data set which is not valid for your country and purpose, it can cause a disturbance in the PV system and lead to problems with the grid operator. When selecting the country data set, you must always observe the locally applicable standards and directives as well as the properties of the PV system (e.g. PV system size, grid-connection point).

- If you are not sure which standards and directives are valid for your country or purpose, contact the grid operator.

i Country data set for operation with external decoupling protection

When operating the PV system with an external decoupling protection, the inverter with a firmware version $\leq 2.99.99.R$ has the country data set **Medium-Voltage Directive (Germany)** or **MVtgDirective** and with a firmware version $\geq 3.00.00.R$ the country data set **DE VDE-AR-N4110:2018 generator ext. Decoup. Protection Device** or **VDEARN4110/18a**. These country data sets allow you to extend the operating range of the inverter for voltage and frequency. These country data sets may only be selected if the PV system is disconnected via external decoupling.

- If the country data set for operation is set with external decoupling protection, only operate the inverter with an external three-phase decoupling protection. Without external three-phase decoupling protection, the inverter will not disconnect from the utility grid when the country-specific standard requirement is exceeded.

i Country data sets for all EU countries still not included in the firmware version $\geq 3.00.00.R$

Since the new grid connection regulations have not yet been defined for all EU countries, the firmware version $\geq 3.00.00.R$ does not yet contain country data sets for all EU countries. A generally valid country data set in accordance with EN 50549 is included instead. It can be used in EU countries for which no country data set is available. For individual EU countries, however, it may be temporarily necessary to make adjustments to the locally valid grid connection regulations via parameter settings. This is done on the basis of the country data set previously valid for the country in the firmware version $\leq 2.99.99.R$.

- It is decided how to proceed according to the locally valid regulations and the SMA manufacturer's declaration valid for the country of use. Set the generally valid country dataset according to EN 50549 with the firmware version $\geq 3.00.00.R$ or select the previously valid country dataset with the firmware version $\leq 2.99.99.R$. Make the parameter settings according to the manufacturer's declaration.

i Change to the names and units of grid parameters to comply with the grid-connection requirements in accordance with Regulation (EU) 2016/631 (valid from April 27, 2019)

To comply with the EU grid-connection requirements (valid from April 27, 2019) the names and units of grid parameters were changed. The change is valid from firmware version $\geq 3.00.00.R$. Names and units of grid parameters for inverters with firmware version $\leq 2.99.99.R$ are not affected by this change and remain valid.

Overview of country data sets and display language for STP xx000TL-30 with a firmware version $\leq 2.99.99.R$

A	B	Country data set	Display language	Country
0	0	Default setting	Default setting	Dependent on parameter set
0	D	Retained	Polish	Dependent on parameter set

A	B	Country data set	Display language	Country
1	0	VDE0126-1-1	German	Germany, Switzerland
1	2	VDE-AR-N4105*	German	Germany
1	6	VDE-AR-N4105-HP**	German	Germany
1	8	VDE0126-1-1	French	Switzerland, France
1	B	VFR2014	French	France
2	0	VDE0126-1-1	Italian	Switzerland
2	8	AS 4777.3	English	Australia
2	A	AS 4777.2	English	Australia
3	2	CEI 0-21 external	Italian	Italy
4	0	RD1699	Spanish	Spain
4	1	RD1663-A/661-A	Spanish	Spain
4	4	Ley2057	Spanish	Chile
4	8	PPC	Retained	Greece
4	9	PPC	English	Greece
5	A	G59/3	English	England
6	0	EN50438	German	Various EU countries
6	1	EN50438	English	
6	2	EN50438	French	
6	3	EN50438	Italian	
6	4	EN50438	Spanish	
6	5	EN50438	Retained	
6	6	EN50438	Retained	
6	7	EN50438	Retained	
6	8	EN50438	Retained	
6	9	EN50438	Retained	
6	E	NEN-EN50438	Dutch	Netherlands
7	8	C10/11/2012	French	Belgium
7	9	C10/11/2012	English	Belgium
7	A	C10/11/2012	German	Belgium

A	B	Country data set	Display language	Country
7	B	C10/11/2012	Dutch	Belgium
A	0	Medium-Voltage Directive Germany	German	Germany
A	1	Medium-Voltage Directive Germany	English	Various countries
A	2	Medium-Voltage Directive Germany	French	France
A	3	Medium-Voltage Directive Germany	Spanish	Spain
A	4	Medium-Voltage Directive Germany	Retained	Czech Republic
A	C	SI4777_HS131_Pf	English	Israel
B	0	MVtgDirective Int.	German	Germany
B	1	MVtgDirective Int.	English	Various countries
B	2	MVtgDirective Int.	French	France
B	3	MVtgDirective Int.	Spanish	Spain
B	4	MVtgDirective Int.	Retained	Czech Republic
B	8	MEA2013	English	Thailand
C	0	Other standard	English	-
C	1	Other standard	German	
C	2	Other standard	French	
C	3	Other standard	Spanish	
C	4	Other standard	Italian	
C	5	Other standard	Greek	
C	6	Other standard	Czech	

A	B	Country data set	Display language	Country
D	0	Island mode 60 Hz	English	-
D	1	Island mode 60 Hz	German	
D	2	Island mode 60 Hz	French	
D	3	Island mode 60 Hz	Spanish	
D	4	Island mode 60 Hz	Italian	
D	5	Island mode 60 Hz	Greek	
D	6	Island mode 60 Hz	Czech	
E	0	Island mode 50 Hz	English	-
E	1	Island mode 50 Hz	German	
E	2	Island mode 50 Hz	French	
E	3	Island mode 50 Hz	Spanish	
E	4	Island mode 50 Hz	Italian	
E	5	Island mode 50 Hz	Greek	
E	6	Island mode 50 Hz	Czech	

* Setting in accordance with VDE-AR-N 4105 for PV systems ≤ 3.68 kVA (Germany)

** Setting in accordance with VDE-AR-N 4105 for PV systems ≤ 13.8 kVA (Germany)

Overview of country data sets and display language for STP xx000TL-30 with a firmware version $\geq 3.00.00.R$

A	B	Country data set	Display language	Country
0	0	Default setting	Default setting	Dependent on parameter set

A	B	Country data set	Display language	Country
1	C	DE VDE-AR-N4105:2018 generator >4.6 kVA	German	Germany
1	D	DE VDE-AR-N4110:2018 generator int. Decoup. Protection Device	German	Germany
1	E	DE VDE-AR-N4110:2018 generator ext. Decoup. Protection Device	German	Germany
2	C	DE VDE-AR-N4105:2018 generator >4.6 kVA	English	Germany
2	D	DE VDE-AR-N4110:2018 generator int. Decoup. Protection Device	English	Germany
2	E	DE VDE-AR-N4110:2018 generator ext. Decoup. Protection Device	English	Germany
3	A	EU EN50549-1:2018 LV	German	Various EU countries
3	B	EU EN50549-1:2018 LV	English	Various EU countries
3	C	EU EN50549-1:2018 LV	French	Various EU countries

A	B	Country data set	Display language	Country
3	D	EU EN50549-1:2018 LV	Italian	Various EU countries
3	E	EU EN50549-1:2018 LV	Spanish	Various EU countries
3	F	EU EN50549-1:2018 LV	Dutch	Various EU countries
5	C	GB ENA-EREC-G99/1:2018	English	Great Britain
7	C	BE C10/11-LV2:2018 LV >10kVA	French	Belgium
7	D	BE C10/11-LV2:2018 LV >10kVA	English	Belgium
7	E	BE C10/11-LV2:2018 LV >10kVA	German	Belgium
7	F	BE C10/11-LV2:2018 LV >10kVA	Dutch	Belgium
8	C	BE C10/11-MV1:2018 MV	French	Belgium
8	D	BE C10/11-MV1:2018 MV	English	Belgium
8	E	BE C10/11-MV1:2018 MV	German	Belgium
8	F	BE C10/11-MV1:2018 MV	Dutch	Belgium

Procedure:

1. Determine the rotary switch position for your country and purpose. Call up the Technical Information "Overview of the Rotary Switch Settings" at www.SMA-Solar.com.

2.

⚠ DANGER**Danger to life due to high voltages**

- Ensure that the inverter is disconnected from all voltage sources and that the enclosure lid is removed (see Section 1.1, page 75).

3. Set the rotary switches **A** and **B** to the required position using a flat-blade screwdriver (blade width: 2.5 mm).

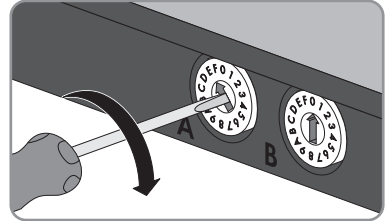

- The inverter will adopt the setting after commissioning. This can take up to five minutes.

7.3 Commissioning the Inverter

⚠ QUALIFIED PERSON**Requirements:**

- The inverter must be correctly mounted.
- The circuit breaker must be correctly rated and mounted.
- All cables must be correctly connected.
- Unused DC inputs must be sealed using the corresponding DC connectors and sealing plugs.
- The country data set must be set correctly for the country or the purpose.
- Unused enclosure openings must be sealed tightly. The factory-mounted filler plugs can be used for that purpose.

Procedure:

1. Make sure that the AC cable is routed so that it cannot be damaged by the partition in the lower enclosure lid.
2. Insert the lower enclosure lid from above and flip it down. The screws must protrude from the lower enclosure lid.

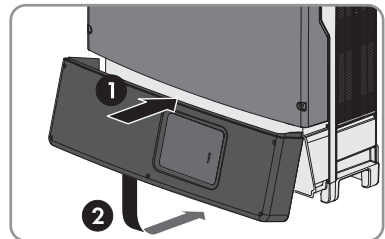

3. Tighten all six screws with an Allen key (AF 3) in the order 1 to 6 (torque: $2.0 \text{ Nm} \pm 0.3 \text{ Nm}$). By tightening the screws in the prescribed order, you avoid warping the enclosure lid, which would keep it from sealing correctly. Tip: If the screws fall out of the lower enclosure lid, insert the long screw into the lower middle hole and the five short screws into the other holes.

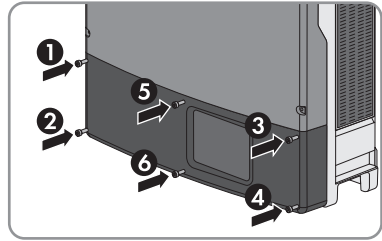

4. Set the DC load-break switch to position **O** so that both mounting screws are visible.

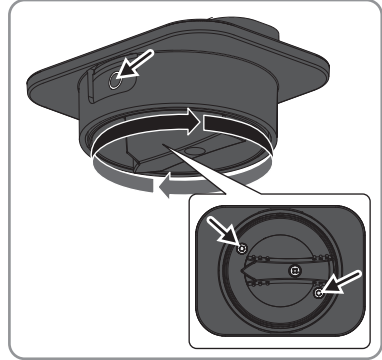

5. Insert the DC load-break switch firmly into the recess on the inverter. During this process, the DC load-break switch must still be in position **O** and aligned so that the screws are positioned over the threads.
6. Fasten the two screws using an Allen key (AF 3) (torque: $2 \text{ Nm} \pm 0.2 \text{ Nm}$).

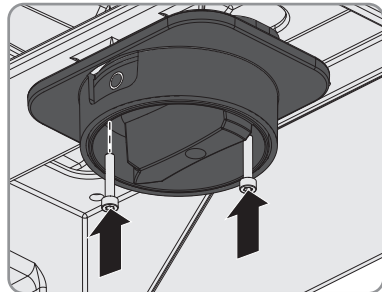

7. Turn the DC load-break switch to the position **I**.

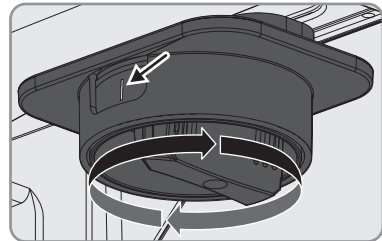

8. Switch on the circuit breaker of all three line conductors.
 - All three LEDs start to glow and the start-up phase begins. The start-up phase may take several minutes.
 - The green LED is glowing. Feed-in operation begins.
9. If the green LED is still flashing, the conditions for activating feed-in operation are not yet met. As soon as the conditions for feed-in operation are met, the inverter starts with feed-in operation and, depending on the available power, the green LED will light up continuously or it will pulse.
10. If the red LED lights up, an event has occurred. Find out which event has occurred and, if necessary, initiate countermeasures.

8 Configuration

8.1 Configuration Procedure

Once you have commissioned the inverter, you may have to adjust various settings via the rotary switches in the inverter or via a communication product. This section describes the procedure for configuration and gives an overview of the steps you must perform in the prescribed order.

Procedure	See
1. If required, integrate the inverter in a Speedwire network.	Section 8.2, page 43
2. To manage the PV system data or to set the inverter parameters, capture the inverter in a communication product.	Manual of the communication product at www.SMA-Solar.com
3. Change the system time and system password.	Manual of the communication product at www.SMA-Solar.com
4. If required, register the inverter in Sunny Portal.	Manual of the SMA Speedwire/Web-connect data module
5. Configure grid management services according to the specifications of the grid operator, if applicable.	Technical Information "SMA GRID GUARD 10.0 - Grid management services through SMA Inverter"
6. If required, reduce the attenuation of ripple control signals.	Section 8.6, page 46
7. For partially shaded PV modules and depending on the given shading situation, you should set the interval at which the inverter optimizes the MPP of the PV system.	Section 8.7, page 46

8.2 Integrating the Inverter into the Network

If the router supports DHCP and DHCP is enabled, the inverter will automatically be integrated into the network. You will not need to carry out network configuration.

If the router does not support DHCP, automatic network configuration will not be possible and you will need to use the SMA Connection Assist to integrate the inverter into the network.

Requirements:

- The inverter must be in operation.
- There must be a router with Internet connection in the local network of the system.
- The inverter must be connected to the router.

Procedure:

- Integrate the inverter into the network by means of the SMA Connection Assist. Download the SMA Connection Assist and install it on the computer (see www.SMA-Solar.com).

8.3 Changing Operating Parameters

This section describes the basic procedure for changing operating parameters. Always change operating parameters as described in this section. Some function-sensitive parameters can only be viewed and changed by qualified persons (for further information on changing parameters, refer to the manual of the communication product).

The operating parameters of the inverter are set to certain values by default. To optimize inverter operation, you can change the operating parameters using a communication product.

Requirements:

- Depending on the type of communication, a computer with Ethernet interface must be available.
- A communication product corresponding to the type of communication used must be available.
- The inverter must be registered in the communication product.
- The changes to the grid-relevant parameters must be approved by the responsible grid operator.
- When changing grid-relevant parameters, the SMA Grid Guard code must be available (see "Application for SMA Grid Guard Code" at www.SMA-Solar.com).

Procedure:

1. Call up the user interface of the communication product or software and log in as **Installer** or **User**.
2. If required, enter the SMA Grid Guard code.
3. Select and set the required parameter.
4. Save settings.

8.4 Configuring the Modbus Function

QUALIFIED PERSON

The Modbus interface is deactivated by default and the communication ports 502 set.

In order to access SMA inverters with SMA Modbus® or SunSpec® Modbus®, the Modbus interface must be activated. After activating the interface, the communication ports of both IP protocols can be changed. For information on commissioning and configuration of the Modbus interface, see the Technical Information "SMA Modbus® Interface" or in the Technical Information "SunSpec® Modbus® Interface" at www.SMA-Solar.com.

i Data security during enabled Modbus interface

If you enable the Modbus interface, there is a risk that unauthorized users may access and manipulate the data or devices in your PV system.

To ensure data security, take appropriate protective measures such as:

- Set up a firewall.
- Close unnecessary network ports.
- Only enable remote access via VPN tunnel.
- Do not set up port forwarding at the communication port in use.
- In order to disable the Modbus interface, reset the inverter to the default settings or disable the parameter again.

Procedure:

- Activate the Modbus interface and adjust the communication ports if necessary (see the technical information "SMA Modbus® Interface" or "SunSpec® Modbus® Interface" at www.SMA-Solar.com).

8.5 Configuring Q on Demand 24/7

With the "Q on Demand 24/7" function, the inverter remains connected to the utility grid overnight and is supplied with power via the utility grid in order that it can provide reactive power. When connected overnight, the inverter only draws an insignificant amount of active power from the utility grid to supply its internal assemblies. The inverter can provide up to 100% of its power as reactive power. The provision of reactive power during feed-in operation leads to a reduction of the feed-in power. This means that at 100% reactive power, the feed-in power is 0%.

The general setting of the grid management services (e.g. cos phi setpoint or Q(V) characteristic curve) can not be fully set independently of the "Q on Demand 24/7" function via the relevant parameters - "Q on Demand 24/7" only permits Q specifications. It is to be noted here that certain settings can have an influence on other grid-support settings and functions.

This means that if the "Q on Demand 24/7" function" is active, no other grid-supporting functions (e.g., cos phi) are possible between day and night operation of the inverter. Should an independent reactive power provision be desired between day- and night operation, the reactive power provision must be communicated to the inverter via a superordinate control unit.

Currently, the provision of reactive power can only be read off via the phase currents and phase voltages in the instantaneous values (**Instantaneous values > AC Side > Phase currents / Phase voltage**) or requested via Modbus.

Procedure:

1. Start Sunny Explorer.
2. Log in as **Installer**.
3. Select **Options > SMA Grid Guard**
4. Enter the SMA Grid Guard code.
5. Select the relevant device in the System tree.
6. Select the tab **Settings** in the device menu.

7. Select **[Edit]**.
8. Select the parameter group **System and device control system > Inverter > Configuration of the static voltage stability**.
9. Set the parameter **Operating mode of the static voltage stability** to the desired operating mode. When doing so, note that for "Q on Demand 24/7", none of the operating modes with cos Phi may be selected.
10. Select the parameter **Operating mode of the static voltage stability for Q on demand** and set this to the desired operating mode also.
11. Depending on the selection of the static voltage stability operating mode, set the parameters associated with the selected operating mode (e.g. the reactive power / voltage characteristic curve Q(V) with or without data points or the reactive power setpoint Q).
12. Click on **[Save]**.

8.6 Reducing the Attenuation of Ripple Control Signals

⚠ QUALIFIED PERSON

By setting certain parameters, the attenuation of three-phase parallel ripple control frequencies ranging from 1000 Hz to 1100 Hz can be avoided. The parameters must only be set in consultation with the responsible grid operator.

The basic procedure for changing operating parameters is explained in another section (see Section 8.3 "Changing Operating Parameters", page 44).

Requirements:

- The firmware version of the inverter must be at least 2.81.07.R.

Procedure:

- Set the following parameters:

SMA Data/ RS485	Definition	Unit	Range	Value to be set
RplDet-NBS-Gain	Ripple control signal detection, amplification of narrow-band backup	V/A	0 to -10	-9
RplDet-NBS-Damp	Ripple control signal detection, attenuation of narrow-band backup	p.u.	-	0.1
RplDet-NBS-Hz	Ripple control signal detection, frequency of the narrow-band backup	Hz	1000 to 1100	Must be specified by the grid operator

8.7 Setting SMA OptiTrac Global Peak

⚠ QUALIFIED PERSON

For partially shaded PV modules, you should set the interval at which the inverter is to optimize the MPP of the PV system. If you do not want to use SMA OptiTrac Global Peak feature, you can deactivate the feature.

The basic procedure for changing operating parameters is explained in another section (see Section 8.3 "Changing Operating Parameters", page 44).

Procedure:

- Select the parameter **Cycle time of the OptiTrac Global Peak algorithm** or **MPPShdw.CycTms** and set the required time interval. The ideal time interval is usually six minutes. This value should only be increased if the shading situation changes extremely slowly.
 - The inverter optimizes the MPP of the PV system at the predetermined time interval.
- In order to deactivate the SMA OptiTrac Global Peak feature, select the parameter **OptiTrac Global Peak switched on** or set **MPPShdw.IsOn** to **Off**.

9 Operation

9.1 Display Overview

The display shows the current operating data of the inverter (e.g. current power, daily energy, total energy) as well as events or errors. Power and energy are displayed as bars in a diagram.

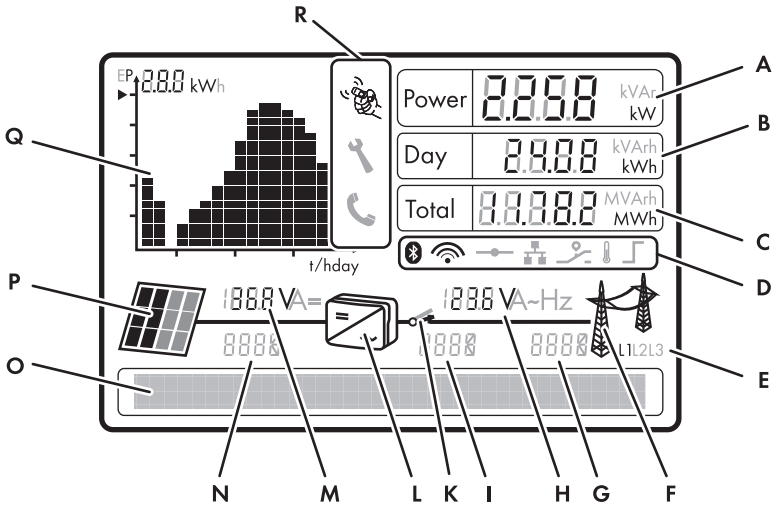









Figure 8: Display overview (example)

Position	Symbol	Explanation
A	-	Current power
B	-	Energy on the current day
C	-	Total amount of energy fed in
D		Active connection to a Speedwire network
		Active connection to Sunny Portal
		Multifunction relay is active
		Power limitation due to excessive temperature
		Active power limitation via PV system control

Position	Symbol	Explanation
E	-	When output voltage is displayed: line conductors between which the output voltage is present When output current is displayed: line conductor to which the output current is allocated
F		Utility grid
G	-	Event number of an error on the utility grid side
H	-	Output voltage or output current of the respective line conductor
I	-	Event number of an error in the inverter
K		Grid relay When the grid relay is closed, the inverter feeds into the utility grid. When the grid relay is open, the inverter is disconnected from the utility grid.
L		Inverter
M	-	Input voltage or input current of the respective line conductor
N	-	Event number of an error on the PV array side
O	-	Text line to display event and error messages
P		PV array
Q	-	Diagram with the power curve of the last 16 feed-in hours or energy yields of the last 16 days <ul style="list-style-type: none"> In order to switch between diagrams, tap once on the enclosure lid.
R		You can operate the display by tapping on the enclosure lid.
		The displayed error must be rectified on-site by a qualified person.
		The displayed error cannot be rectified on-site. <ul style="list-style-type: none"> Contact the service.

9.2 Activating and Operating the Display

You can activate and operate the display by tapping on the enclosure lid.

Procedure:

1. Activate the display. Tap on the enclosure lid once.
 - The backlight is switched on.
2. To move to the next line, tap on the enclosure lid once.
3. In order to switch between the power curve of the last 16 feed-in hours and the energy yields of the last 16 days in the diagram, tap on the enclosure lid once.

9.3 Changing the Display Language

QUALIFIED PERSON

If the language for the country data set is not the language you want to use, you can change the display language as follows:

Overview of rotary switch settings:

A	B	Country data set	Display language	Country
0	0	Default setting	Default setting	Dependent on parameter set
0	1	Retained	English	Dependent on parameter set
0	2	Retained	German	Dependent on parameter set
0	3	Retained	French	Dependent on parameter set
0	4	Retained	Spanish	Dependent on parameter set
0	5	Retained	Italian	Dependent on parameter set
0	6	Retained	Greek	Dependent on parameter set
0	7	Retained	Czech	Dependent on parameter set
0	8	Retained	Korean	Dependent on parameter set
0	9	Retained	Portuguese	Dependent on parameter set

A	B	Country data set	Display language	Country
0	A	Retained	Dutch	Dependent on parameter set
0	B	Retained	Slovenian	Dependent on parameter set
0	C	Retained	Bulgarian	Dependent on parameter set
0	D	Retained	Polish	Dependent on parameter set

Procedure:

1.

⚠ DANGER**Danger to life due to high voltages**

- Disconnect the inverter from all voltage sources and open the enclosure lid (see Section 11, page 75).

- Determine the rotary switch setting for the desired display language.
 - Set the rotary switch **A** to **0** using a flat-blade screwdriver (blade width: 2.5 mm). This ensures that the selected data country set remains unchanged.
 - Set the rotary switch **B** to the required language using a flat-blade screwdriver (blade width: 2.5 mm).
 - Recommission the inverter (see Section 7.3, page 40).
- The inverter adopts the settings after commissioning. This can take up to five minutes.

9.4 Calling Up Display Messages of the Start-Up Phase

Various inverter information is displayed during the start-up phase that can be called up whenever required during operation.

Procedure:

- Tap on the enclosure lid twice.
 - The display shows all messages of the start-up phase in sequence.

9.5 Updating the Firmware

⚠ QUALIFIED PERSON

If no automatic update is set in the communication product (e.g., SMA Cluster Controller) or in Sunny Portal, you have the option of carrying out a manual firmware update.

i Sufficient DC voltage required for firmware update

Only perform the update if there is sufficient solar irradiation and DC voltage. During the update, the inverter must be in feed-in operation.

i **The update from firmware version $\leq 2.99.99.R$ to $\geq 3.00.00.R$ is only possible with the country data set "Other standard."**

To update the firmware from $\leq 2.99.99.R$ to $\geq 3.00.00.R$ the country data set must be set to **Other standard**. Otherwise, it is not possible to update the firmware.

- Before the update, set the country data set of the inverter to **Other standard** by using the rotary switches or via a communication product (see Section 7.2, page 33).
- Ensure that the inverter firmware version is $\geq 3.00.00.R$ after the update. Set the required country data set by using the rotary switches or via a communication product (see Section 7.2, page 33).

Requirements:

- An SD memory card with a maximum memory capacity of 2 GB is required.
- The SD memory card must be formatted as FAT32.
- An "Update" directory must be created on the SD memory card.
- The update file must be available and saved in the "Update" directory to the SD memory card.

Procedure:

1.

⚠ DANGER

Danger to life due to electric shock

- Disconnect the inverter from all voltage sources and open the lower enclosure lid (see Section 11, page 75).

2. Loosen the screw of the communication assembly and slightly flip up the communication assembly.
3. Insert the SD memory card into the slot with the slanted corner facing downward until it locks into place.
4. Fold the communication assembly downwards and tighten the screw.
5. Commission the inverter (see Section 7.3, page 40).
 - The firmware is being updated during commissioning. As soon as the "Update completed" message is displayed, the firmware update is completed. The message is displayed for 30 seconds. Afterwards, the inverter displays its initialization messages.
6. If the firmware update failed, repeat the process.
7. Check the firmware version. To do this, access the user interface of the communication product or Sunny Portal.
8. If the updated has been successfully updated, remove the SD memory card from the inverter. To do this, proceed as follows.

9.

⚠ DANGER

Danger to life due to electric shock

- Disconnect the inverter from all voltage sources and open the lower enclosure lid (see Section 11, page 75).

10. Loosen the screw of the communication assembly and slightly flip up the communication assembly.
11. Slightly press in the SD memory card and release it.
 - The SD memory card jumps out of the slot.
12. Remove the SD memory card.
13. Fold the communication assembly downwards and tighten the screw.
14. Commission the inverter (see Section 7.3, page 40).
15. If necessary, repeat inverter detection in the communication product (see the manual for the communication product).

10 Troubleshooting

10.1 Event Messages

Event number	Message, cause and corrective measures
101 102 103	<p>⚠ QUALIFIED PERSON</p> <p>Grid fault</p> <p>The grid voltage or grid impedance at the connection point of the inverter is too high. The inverter has disconnected from the utility grid.</p> <p>Corrective measures:</p> <ul style="list-style-type: none"> • Check whether the grid voltage at the connection point of the inverter is permanently in the permissible range. <p>If the grid voltage is outside the permissible range due to local grid conditions, contact the grid operator. The grid operator must agree with an adjustment of the voltage at the feed-in point or with a change of the monitored operating limits.</p> <p>If the grid voltage is permanently within the permissible range and this message is still displayed, contact Service.</p>
202 203	<p>⚠ QUALIFIED PERSON</p> <p>Grid fault</p> <p>The utility grid has been disconnected, the AC cable is damaged or the grid voltage at the connection point of the inverter is too low. The inverter has disconnected from the utility grid.</p> <p>Corrective measures:</p> <ol style="list-style-type: none"> 1. Ensure that the circuit breaker is switched on. 2. Make sure that the AC cable is not damaged. 3. Make sure that the AC cable is correctly connected. 4. Check whether the grid voltage at the connection point of the inverter is permanently in the permissible range. <p>If the grid voltage is outside the permissible range due to local grid conditions, contact the grid operator. The grid operator must agree with an adjustment of the voltage at the feed-in point or with a change of the monitored operating limits.</p> <p>If the grid voltage is permanently within the permissible range and this message is still displayed, contact Service.</p>

Event number	Message, cause and corrective measures
301	<p data-bbox="311 188 582 220">⚠ QUALIFIED PERSON</p> <p data-bbox="288 236 392 260">Grid fault</p> <p data-bbox="288 272 994 384">The ten-minute average value of the grid voltage is no longer within the permissible range. The grid voltage or grid impedance at the connection point is too high. The inverter disconnects from the utility grid to maintain power quality.</p> <p data-bbox="288 395 507 419">Corrective measures:</p> <ul data-bbox="311 427 994 667" style="list-style-type: none"> <li data-bbox="311 427 994 483">• Check whether the grid voltage at the connection point of the inverter is permanently in the permissible range. If the grid voltage is outside the permissible range due to local grid conditions, contact the grid operator. The grid operator must agree with an adjustment of the voltage at the feed-in point or with a change of the monitored operating limits. If the grid voltage is permanently within the permissible range and this message is still displayed, contact Service.
401 402 403 404	<p data-bbox="311 683 582 715">⚠ QUALIFIED PERSON</p> <p data-bbox="288 730 392 754">Grid fault</p> <p data-bbox="288 767 977 823">The inverter is no longer in grid-parallel operation and has stopped feeding into the utility grid.</p> <p data-bbox="288 834 507 858">Corrective measures:</p> <ul data-bbox="311 866 1005 893" style="list-style-type: none"> <li data-bbox="311 866 1005 893">• Check the grid connection for significant short-term frequency fluctuations.
501	<p data-bbox="311 906 582 938">⚠ QUALIFIED PERSON</p> <p data-bbox="288 954 392 978">Grid fault</p> <p data-bbox="288 991 988 1046">The power frequency is not within the permissible range. The inverter has disconnected from the utility grid.</p> <p data-bbox="288 1058 507 1082">Corrective measures:</p> <ul data-bbox="311 1090 1005 1303" style="list-style-type: none"> <li data-bbox="311 1090 1005 1303">• If possible, check the power frequency and observe how often fluctuations occur. If fluctuations occur frequently and this message is displayed often, contact the grid operator. The grid operator must approve changes to the operating parameters of the inverter. If the grid operator gives his approval, discuss any changes to the operating parameters with the Service.

Event number	Message, cause and corrective measures
601	<p data-bbox="311 185 596 220">⚠ QUALIFIED PERSON</p> <p data-bbox="288 236 393 260">Grid fault</p> <p data-bbox="288 272 978 325">The inverter has detected an excessively high proportion of direct current in the grid current.</p> <p data-bbox="288 336 508 360">Corrective measures:</p> <ol data-bbox="311 368 967 456" style="list-style-type: none"> <li data-bbox="311 368 736 392">1. Check the grid connection for direct current. <li data-bbox="311 400 967 456">2. If this message is displayed frequently, contact the grid operator and check whether the monitoring threshold on the inverter can be raised.
701	<p data-bbox="311 472 596 507">⚠ QUALIFIED PERSON</p> <p data-bbox="288 523 676 547">Frq. not permitted > Check parameter</p> <p data-bbox="288 560 992 612">The power frequency is not within the permissible range. The inverter has disconnected from the utility grid.</p> <p data-bbox="288 624 508 647">Corrective measures:</p> <ul data-bbox="311 655 1012 863" style="list-style-type: none"> <li data-bbox="311 655 908 708">• If possible, check the power frequency and observe how often fluctuations occur. If fluctuations occur frequently and this message is displayed often, contact the grid operator. The grid operator must approve changes to the operating parameters of the inverter. If the grid operator gives his approval, discuss any changes to the operating parameters with the Service.
1302	<p data-bbox="311 879 596 914">⚠ QUALIFIED PERSON</p> <p data-bbox="288 930 1001 983">Waiting for grid voltage > Installation failure grid connection > Check grid and fuses</p> <p data-bbox="288 995 997 1048">The inverter has detected an error in the AC cabling. The inverter cannot connect to the utility grid.</p> <p data-bbox="288 1059 508 1083">Corrective measures:</p> <ol data-bbox="311 1091 1003 1182" style="list-style-type: none"> <li data-bbox="311 1091 706 1115">1. Ensure that the AC connection is correct. <li data-bbox="311 1123 1003 1182">2. Ensure that the country data set has been configured correctly. Select the parameter Country country set or CntrySet and check its value.
1501	<p data-bbox="311 1198 596 1233">⚠ QUALIFIED PERSON</p> <p data-bbox="288 1249 527 1273">Reconnection fault grid</p> <p data-bbox="288 1286 994 1369">The changed country data set or the value of a parameter you have set does not correspond to the local requirements. The inverter cannot connect to the utility grid.</p> <p data-bbox="288 1380 508 1404">Corrective measures:</p> <ul data-bbox="311 1412 1003 1471" style="list-style-type: none"> <li data-bbox="311 1412 1003 1471">• Ensure that the country data set has been configured correctly. Select the parameter Country data set or CntrySet and check its value.

Event number	Message, cause and corrective measures
3301	<p data-bbox="311 188 596 220">⚠ QUALIFIED PERSON</p> <p data-bbox="288 236 777 263">Unstable operation > Generator output too low</p> <p data-bbox="288 272 1003 384">There is not enough power at the DC input of the inverter for stable operation. This may be caused by snow on the PV modules or insufficient irradiation. The inverter interrupts feed-in operation and can no longer connect to the utility grid.</p> <p data-bbox="288 394 508 419">Corrective measures:</p> <ol data-bbox="311 429 1003 515" style="list-style-type: none"><li data-bbox="311 429 751 454">1. If irradiation is too low, wait for it to increase.<li data-bbox="311 461 1003 515">2. If this message is displayed frequently, ensure that the PV array has been correctly rated and wired.
3302	<p data-bbox="311 534 596 566">⚠ QUALIFIED PERSON</p> <p data-bbox="288 582 654 609">Unstable operation > Abort self-test</p> <p data-bbox="288 619 1003 730">There is not enough power at the DC input of the inverter for stable operation. This may be caused by snow on the PV modules or insufficient irradiation. The inverter interrupts feed-in operation and can no longer connect to the utility grid.</p> <p data-bbox="288 740 508 766">Corrective measures:</p> <ol data-bbox="311 775 1003 861" style="list-style-type: none"><li data-bbox="311 775 751 801">1. If irradiation is too low, wait for it to increase.<li data-bbox="311 807 1003 861">2. If this message is displayed frequently, ensure that the PV array has been correctly rated and wired.
3303	<p data-bbox="311 880 596 912">⚠ QUALIFIED PERSON</p> <p data-bbox="288 928 736 956">Unstable operation > Data storage blocked</p> <p data-bbox="288 965 1003 1077">There is not enough power at the DC input of the inverter for stable operation. This may be caused by snow on the PV modules or insufficient irradiation. The inverter interrupts feed-in operation and can no longer connect to the utility grid.</p> <p data-bbox="288 1086 508 1112">Corrective measures:</p> <p data-bbox="311 1121 596 1153">⚠ QUALIFIED PERSON</p> <ol data-bbox="311 1169 1003 1256" style="list-style-type: none"><li data-bbox="311 1169 751 1195">1. If irradiation is too low, wait for it to increase.<li data-bbox="311 1201 1003 1256">2. If this message is displayed frequently, ensure that the PV array has been correctly rated and wired.

Event number	Message, cause and corrective measures
3401 3402	<p data-bbox="311 183 593 215">⚠ QUALIFIED PERSON</p> <p data-bbox="288 231 694 263">DC overvoltage > Disconnect generator</p> <p data-bbox="288 271 817 295">Overvoltage at the DC input. This can destroy the inverter.</p> <p data-bbox="288 303 504 327">Corrective measures:</p> <ol data-bbox="311 335 974 422" style="list-style-type: none"> <li data-bbox="311 335 884 359">1. Immediately disconnect the inverter from all voltage sources. <li data-bbox="311 367 974 422">2. Check whether the DC voltage is below the maximum input voltage of the inverter. <p data-bbox="288 430 912 486">If the DC voltage is below the maximum input voltage of the inverter, reconnect the DC connectors to the inverter.</p> <p data-bbox="288 494 985 582">If the DC voltage is above the maximum input voltage of the inverter, ensure that the PV array has been correctly rated or contact the installer of the PV array.</p> <ol data-bbox="311 590 862 614" style="list-style-type: none"> <li data-bbox="311 590 862 614">3. If this message is repeated frequently, contact the Service.
3501	<p data-bbox="311 630 593 662">⚠ QUALIFIED PERSON</p> <p data-bbox="288 678 694 710">Insulation resistance > Check generator</p> <p data-bbox="288 718 800 742">The inverter has detected a ground fault in the PV array.</p> <p data-bbox="288 750 504 774">Corrective measures:</p> <ul data-bbox="311 782 683 805" style="list-style-type: none"> <li data-bbox="311 782 683 805">• Check the PV system for ground faults.
3601	<p data-bbox="311 821 593 853">⚠ QUALIFIED PERSON</p> <p data-bbox="288 869 694 901">High discharge curr. > Check generator</p> <p data-bbox="288 909 991 965">The leakage currents of the inverter and the PV array are too high. There is a ground fault, a residual current or a malfunction.</p> <p data-bbox="288 973 996 1085">The inverter interrupts feed-in operation immediately after exceeding a threshold and then automatically reconnects to the utility grid. If this process happens five times a day, the inverter disconnects from the utility grid and terminates feed-in.</p> <p data-bbox="288 1093 504 1117">Corrective measures:</p> <ul data-bbox="311 1125 683 1149" style="list-style-type: none"> <li data-bbox="311 1125 683 1149">• Check the PV system for ground faults.
3701	<p data-bbox="311 1173 593 1204">⚠ QUALIFIED PERSON</p> <p data-bbox="288 1220 677 1252">Resid.curr.too.high > Check generator</p> <p data-bbox="288 1260 1008 1316">The inverter has detected a residual current due to temporary grounding of the PV array.</p> <p data-bbox="288 1324 504 1348">Corrective measures:</p> <ul data-bbox="311 1356 683 1380" style="list-style-type: none"> <li data-bbox="311 1356 683 1380">• Check the PV system for ground faults.

Event number	Message, cause and corrective measures
3801 3802	<p data-bbox="292 185 596 220">⚠ QUALIFIED PERSON</p> <p data-bbox="292 236 642 263">DC overcurrent > Check generator</p> <p data-bbox="292 272 981 300">Overcurrent at the DC input. The inverter briefly interrupts feed-in operation.</p> <p data-bbox="292 309 508 336">Corrective measures:</p> <ul data-bbox="311 341 1003 395" style="list-style-type: none"> <li data-bbox="311 341 1003 395">• If this message is displayed frequently, ensure that the PV array has been correctly rated and wired.
3901 3902	<p data-bbox="292 411 596 446">⚠ QUALIFIED PERSON</p> <p data-bbox="292 462 824 489">Waiting for DC start conditions > Start cond. not met</p> <p data-bbox="292 499 829 526">The feed-in conditions for the utility grid are not yet fulfilled.</p> <p data-bbox="292 536 508 563">Corrective measures:</p> <ol data-bbox="311 568 981 751" style="list-style-type: none"> <li data-bbox="311 568 751 595">1. If irradiation is too low, wait for it to increase. <li data-bbox="311 600 981 687">2. If this message is displayed frequently in the morning, increase the voltage limit for starting grid feed-in. Change the parameter minimum voltage input or A.VStr, B.VStr. <li data-bbox="311 692 981 751">3. If this message is displayed frequently with medium irradiation, ensure that the PV array is correctly rated.
6001-6438	<p data-bbox="292 762 596 798">⚠ QUALIFIED PERSON</p> <p data-bbox="292 813 654 841">Self diagnosis > Interference device</p> <p data-bbox="292 850 708 877">The cause must be determined by the Service.</p> <p data-bbox="292 887 508 914">Corrective measures:</p> <ul data-bbox="311 919 516 946" style="list-style-type: none"> <li data-bbox="311 919 516 946">• Contact the service.
6501-6511	<p data-bbox="292 960 596 995">⚠ QUALIFIED PERSON</p> <p data-bbox="292 1011 654 1038">Self diagnosis > Interference device</p> <p data-bbox="292 1048 827 1075">The inverter has switched off due to excessive temperature.</p> <p data-bbox="292 1085 508 1112">Corrective measures:</p> <ol data-bbox="311 1117 770 1179" style="list-style-type: none"> <li data-bbox="311 1117 474 1144">1. Clean the fans. <li data-bbox="311 1149 770 1179">2. Ensure that the inverter has sufficient ventilation.
6512	<p data-bbox="292 1190 757 1217">Minimum operating temperature not reached</p> <p data-bbox="292 1227 949 1281">The inverter will only recommence grid feed-in once the temperature has reached at least -25°C.</p>

Event number	Message, cause and corrective measures
6603 6604	<p data-bbox="292 181 596 220">⚠ QUALIFIED PERSON</p> <p data-bbox="292 236 557 261">Self-diagnosis > Overload</p> <p data-bbox="292 272 708 298">The cause must be determined by the Service.</p> <p data-bbox="292 309 508 335">Corrective measures:</p> <ul data-bbox="311 344 516 370" style="list-style-type: none"> <li data-bbox="311 344 516 370">• Contact the service.
6606	<p data-bbox="292 381 596 419">⚠ QUALIFIED PERSON</p> <p data-bbox="292 435 488 461">Interference device</p> <p data-bbox="292 472 708 497">The cause must be determined by the Service.</p> <p data-bbox="292 509 508 534">Corrective measures:</p> <ul data-bbox="311 544 516 569" style="list-style-type: none"> <li data-bbox="311 544 516 569">• Contact the service.
6701 6702	<p data-bbox="292 580 596 619">⚠ QUALIFIED PERSON</p> <p data-bbox="292 635 555 660">Communication disturbed</p> <p data-bbox="292 671 708 697">The cause must be determined by the Service.</p> <p data-bbox="292 708 508 734">Corrective measures:</p> <ul data-bbox="311 743 516 769" style="list-style-type: none"> <li data-bbox="311 743 516 769">• Contact the service.
6801 6802	<p data-bbox="292 780 596 818">⚠ QUALIFIED PERSON</p> <p data-bbox="292 834 631 860">Self-diagnosis > Input A defective</p> <p data-bbox="292 871 708 896">The cause must be determined by the Service.</p> <p data-bbox="292 908 508 933">Corrective measures:</p> <ul data-bbox="311 943 516 968" style="list-style-type: none"> <li data-bbox="311 943 516 968">• Contact the service.
6901 6902	<p data-bbox="292 979 596 1018">⚠ QUALIFIED PERSON</p> <p data-bbox="292 1034 628 1059">Self-diagnosis > Input B defective</p> <p data-bbox="292 1070 708 1096">The cause must be determined by the Service.</p> <p data-bbox="292 1107 508 1133">Corrective measures:</p> <ul data-bbox="311 1142 516 1168" style="list-style-type: none"> <li data-bbox="311 1142 516 1168">• Contact the service.
7001 7002	<p data-bbox="292 1179 596 1217">⚠ QUALIFIED PERSON</p> <p data-bbox="292 1233 622 1259">Sensor fault fan permanently on</p> <p data-bbox="292 1270 708 1295">The cause must be determined by the Service.</p> <p data-bbox="292 1307 508 1332">Corrective measures:</p> <ul data-bbox="311 1342 516 1367" style="list-style-type: none"> <li data-bbox="311 1342 516 1367">• Contact the service.

Event number	Message, cause and corrective measures
7101	<p>⚠ QUALIFIED PERSON</p> <p>SD memory card defective The SD memory card is not formatted.</p> <p>Corrective measures:</p> <ul style="list-style-type: none"> • Re-format the SD memory card. • Re-save the files to the SD memory card.
7102	<p>⚠ QUALIFIED PERSON</p> <p>Parameter file not found or defective The parameter file was not found or is defective. The update failed. The inverter continues to feed in.</p> <p>Corrective measures:</p> <ul style="list-style-type: none"> • Copy the parameter file to the correct folder again.
7105	<p>⚠ QUALIFIED PERSON</p> <p>Param. setting failed Parameters could not be set using the memory card. The inverter continues to feed in.</p> <p>Corrective measures:</p> <ul style="list-style-type: none"> • Ensure that the parameters are set correctly. • Ensure that the SMA Grid Guard code is available.
7106	<p>⚠ QUALIFIED PERSON</p> <p>Update file defect. Update file on the memory card is defective.</p> <p>Corrective measures:</p> <ul style="list-style-type: none"> • Reformat the memory card. • Re-save the files to the memory card.
7110	<p>⚠ QUALIFIED PERSON</p> <p>No update file found No update file has been found.</p> <p>Corrective measures:</p> <ul style="list-style-type: none"> • Copy the update file to the memory card folder. Select the folder \UPDATE.

Event number	Message, cause and corrective measures
7201 7202	<p data-bbox="311 188 596 220">⚠ QUALIFIED PERSON</p> <p data-bbox="288 236 490 260">Data stor. not poss.</p> <p data-bbox="288 272 863 296">Internal error. The inverter continues to feed into the utility grid.</p> <p data-bbox="288 309 508 333">Corrective measures:</p> <ul data-bbox="311 341 516 365" style="list-style-type: none"> • Contact the service.
7303	<p data-bbox="311 387 596 419">⚠ QUALIFIED PERSON</p> <p data-bbox="288 435 540 459">Update main CPU failed</p> <p data-bbox="288 472 708 496">The cause must be determined by the Service.</p> <p data-bbox="288 509 508 533">Corrective measures:</p> <ul data-bbox="311 541 516 564" style="list-style-type: none"> • Contact the service.
7305	<p data-bbox="311 587 596 619">⚠ QUALIFIED PERSON</p> <p data-bbox="288 635 596 659">Update RS485i module failed</p> <p data-bbox="288 671 596 695">Update of RS485i module failed.</p> <p data-bbox="288 708 508 732">Corrective measures:</p> <ul data-bbox="311 740 680 796" style="list-style-type: none"> • Retry update. • If the error recurs, contact the Service.
7311	<p data-bbox="311 818 596 850">⚠ QUALIFIED PERSON</p> <p data-bbox="288 866 596 890">Update language table failed</p> <p data-bbox="288 903 619 927">Updating the language table failed.</p> <p data-bbox="288 940 508 963">Corrective measures:</p> <ul data-bbox="311 971 680 1027" style="list-style-type: none"> • Retry update. • If the error recurs, contact the Service.
7316	<p data-bbox="311 1050 596 1082">⚠ QUALIFIED PERSON</p> <p data-bbox="288 1098 633 1121">Update Speedwire module failed</p> <p data-bbox="288 1134 650 1158">Updating the Speedwire module failed.</p> <p data-bbox="288 1171 508 1195">Corrective measures:</p> <ul data-bbox="311 1203 680 1259" style="list-style-type: none"> • Retry update. • If the error recurs, contact the Service.

Event number	Message, cause and corrective measures
7326	<p>⚠ QUALIFIED PERSON</p> <p>Webconnect update failed Update of Webconnect module failed.</p> <p>Corrective measures:</p> <ul style="list-style-type: none"> • Retry update. • If the error recurs, contact the Service.
7701 7702 7703	<p>⚠ QUALIFIED PERSON</p> <p>Self diagnosis > Interference device The cause must be determined by the Service.</p> <p>Corrective measures:</p> <ul style="list-style-type: none"> • Contact the service.
8001	<p>⚠ QUALIFIED PERSON</p> <p>Derating occurred The inverter has reduced its power output for more than ten minutes due to excessive temperature.</p> <p>Corrective measures:</p> <ul style="list-style-type: none"> • Clean the cooling fins on the rear of the enclosure and the air ducts on the top using a soft brush. • Ensure that the inverter has sufficient ventilation.
8101 8102 8103 8104	<p>⚠ QUALIFIED PERSON</p> <p>Communication disturbed The cause must be determined by the Service.</p> <p>Corrective measures:</p> <ul style="list-style-type: none"> • Contact the service.
9002	<p>⚠ QUALIFIED PERSON</p> <p>Installer code invalid The SMA Grid Guard code entered is incorrect. The operating parameters are still protected and cannot be changed.</p> <p>Corrective measures:</p> <ul style="list-style-type: none"> • Enter the correct SMA Grid Guard code.

Event number	Message, cause and corrective measures
9003	<p>⚠ QUALIFIED PERSON</p> <p>Grid parameter locked</p> <p>The parameters are now locked. You cannot change the parameters.</p> <p>Corrective measures:</p> <ul style="list-style-type: none"> • Unlock the parameters with the SMA Grid Guard code.
9005	<p>⚠ QUALIFIED PERSON</p> <p>Changing of grid parameters not possible > Ensure DC supply</p> <p>PV power is too low for setting the country data set. As soon as sufficient irradiation is available, the inverter assumes the setting automatically.</p>

10.2 Cleaning the Fans

⚠ QUALIFIED PERSON

10.2.1 Cleaning the Fan at the Bottom

⚠ QUALIFIED PERSON

First clean the fan at the bottom of the inverter and then clean the fan on the left-hand side of the enclosure.

Procedure:

1.

⚠ DANGER

Danger to life due to electric shock

- Disconnect the inverter from all voltage sources (see Section 11 "Disconnecting the Inverter from Voltage Sources", page 75).

2. Wait for the fan to stop rotating.
3. Remove the fan guard and clean it:
 - Use a screwdriver to push the two locking tabs at the right-hand edge of the fan guard to the right-hand side and remove them from the retainer.

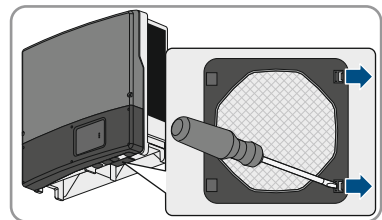

- Carefully remove the fan guard.
- Clean the fan guard with a soft brush, a paint brush, a cloth or compressed air.

4. Press the locking tabs on the fan toward the center of the fan.

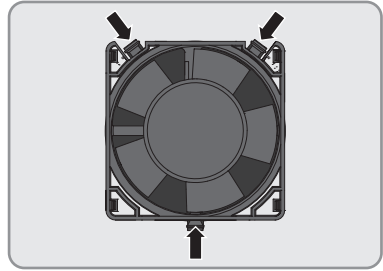

5. Carefully remove the fan from the inverter.
6. Release and remove the fan plug.

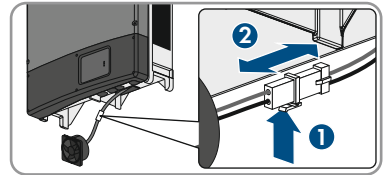

7. **NOTICE**

Damage to the fan due to compressed air

- Clean the fan only with a soft brush, a paint brush, or a damp cloth.

8. After cleaning, insert the fan plug back into the pin connector until it snaps into place.

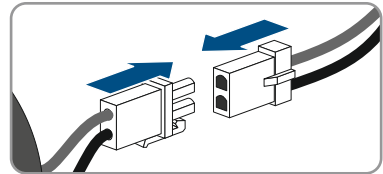

9. Insert the fan into the inverter until it snaps into place.
10. Push the fan guard into the retainer until it snaps into place.
11. Clean the fan on the left-hand side of the enclosure (see Section 10.2.2 "Cleaning the Fan on the Left-Hand Side of the Enclosure", page 65).

10.2.2 Cleaning the Fan on the Left-Hand Side of the Enclosure

⚠ QUALIFIED PERSON

1. **⚠ DANGER**

Danger to life due to electric shock

- Disconnect the inverter from all voltage sources (see Section 11 "Disconnecting the Inverter from Voltage Sources", page 75).

2. Remove the ventilation grids on the left-hand and right-hand sides and clean them:

- Turn the rotary fastener of the ventilation grid with a flat-blade screwdriver until the notch is in a vertical position.

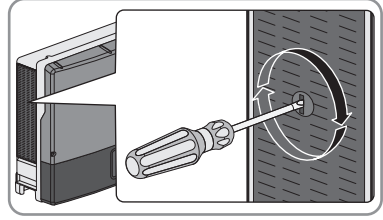

- Remove the ventilation grid. Use a screwdriver to gently lever open the ventilation grid.

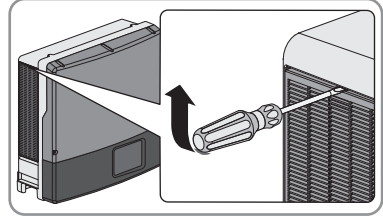

- Clean the ventilation grid with a soft brush, a paint brush, or compressed air.

3. NOTICE

Damage to the inverter due to foreign bodies

- Do not remove the ventilation grids permanently, otherwise, foreign bodies could penetrate the enclosure.

4. Wait for the fan to stop rotating.
5. Press the locking tabs of the fan to the center of the fan.

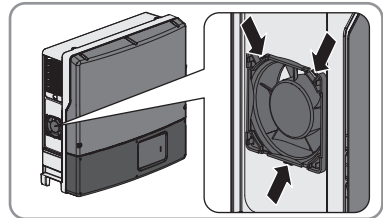

6. Carefully remove the fan from the inverter.
7. Release and disconnect the fan plug.

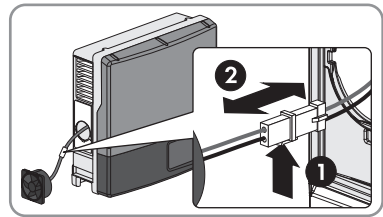

8. NOTICE

Damage to the fan due to compressed air

- Clean the fan only with a soft brush, paint brush or damp cloth.

9. After cleaning, insert the fan plug into the pin connector until it snaps into place.

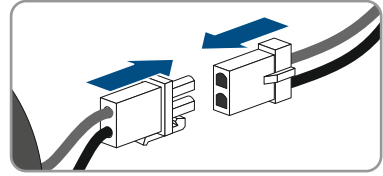

10. Insert the fan into the inverter until it snaps into place.

11. Attach the ventilation grids on the right-hand and left-hand sides of the inverter:

- Reinsert the ventilation grid until it snaps into place.

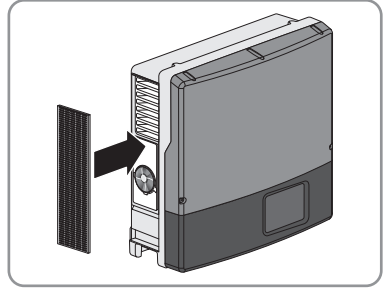

- Turn the rotary lock on the ventilation grid with a flat-blade screwdriver until the slot is in a horizontal position and the arrows point to the right.

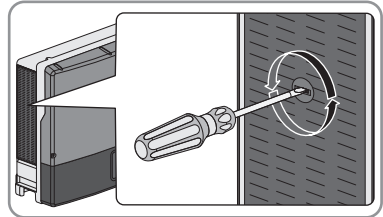

- Ensure that the ventilation grid is securely in place.

12. Recommission the inverter (see Section 7.3, page 40).

13. Check the fans to ensure that they are working properly (see Section 10.3, page 67).

10.3 Checking the Function of the Fans

⚠ QUALIFIED PERSON

You can check the function of the fans by setting a parameter.

The basic procedure for changing operating parameters is described in the manual of the inverter or the communication product (see the operating manual of the inverter or communication product).

Procedure:

1. Select the parameter **Fan test** or **FanTst** and set to **On**.
2. Save settings.

3. Check whether air is being drawn in through the bottom and is coming out of the upper ventilation grid and whether the fan is making any unusual noises.
If no air is being drawn in through the bottom, no air is coming out of the ventilation grid, or the fan is making unusual noises, then the fan may have been installed incorrectly. Check whether the fan has been installed correctly.
If the fans were installed correctly, contact Service (see Section 16, page 90).
4. Select the parameter **Fan test** or **FanTst** and set to **Off**.
5. Save settings.

10.4 Checking the PV System for Ground Faults

QUALIFIED PERSON

If the inverter displays the event numbers **3501**, **3601** or **3701**, there could be a ground fault. The electrical insulation from the PV system to ground is defective or insufficient.

DANGER

Danger to life due to electric shock when touching live system components in case of a ground fault

If a ground fault occurs, parts of the system may still be live. Touching live parts and cables results in death or lethal injuries due to electric shock.

- Disconnect the product from voltage sources and make sure it cannot be reconnected before working on the device.
- Touch the cables of the PV array on the insulation only.
- Do not touch any parts of the substructure or frame of the PV array.
- Do not connect PV strings with ground faults to the inverter.
- Ensure that no voltage is present and wait five minutes before touching any parts of the PV system or the product.

WARNING

Danger to life due to electric shock from destruction of the measuring device due to overvoltage

Overvoltage can damage a measuring device and result in voltage being present in the enclosure of the measuring device. Touching the live enclosure of the measuring device results in death or lethal injuries due to electric shock.

- Only use measuring devices with a DC input voltage range of 1000 V or higher.

Procedure:

In order to check the PV system for ground faults, perform the following actions in the prescribed order. The exact procedure is described in the following sections.

- Check the PV system for ground faults by measuring the voltage.
- If the voltage measurement was not successful, check the PV system via insulation resistance measurement for ground faults.

Test by Measuring the Voltage

Proceed as follows to check each string in the PV system for ground faults.

Procedure:

1.

⚠ DANGER

Danger to life due to high voltages

- Disconnect the inverter from all voltage sources (see Section 11, page 75).

2. Measure the voltages:

- Measure the voltage between the positive terminal and the ground potential (PE).
- Measure the voltage between the negative terminal and the ground potential (PE).
- Measure the voltage between the positive and negative terminals.

If the following results are present at the same time, there is a ground fault in the PV system:

- All measured voltages are stable.
- The sum of the two voltages to ground potential is approximately equal to the voltage between the positive and negative terminals.

3. If a ground fault is present, determine the location of the ground fault via the ratio of the two measured voltages and eliminate the ground fault.
4. If a definite ground fault cannot be measured and the message is still displayed, measure the insulation resistance.
5. Reconnect the strings without ground faults to the inverter and recommission the inverter (see inverter installation inverter).

Location of the ground fault

The example shows a ground fault between the second and third PV module.

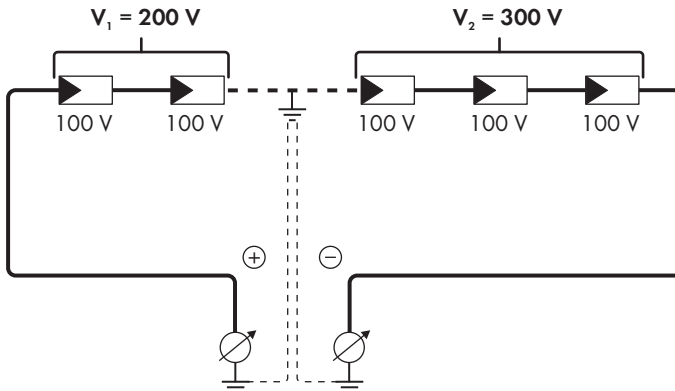

Test by Measuring the Insulation Resistance

If the voltage measurement does not provide sufficient evidence of a ground fault, the insulation resistance measurement can provide more exact results.

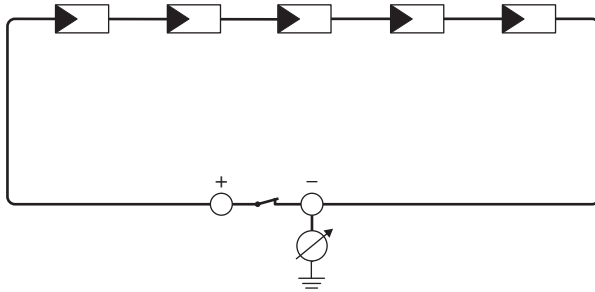

Figure 9: Schematic diagram of the measurement

i Calculating the insulation resistance

The expected total resistance of the PV system or of an individual string can be calculated using the following formula:

$$\frac{1}{R_{\text{total}}} = \frac{1}{R_1} + \frac{1}{R_2} + \frac{1}{R_3} + \dots$$

The exact insulation resistance of a PV module can be obtained from the module manufacturer or the datasheet.

For the resistance of a PV module an average value can be assumed: for thin-film PV modules approximately 40 MOhm and for polycrystalline and monocrystalline PV modules approximately 50 MOhm per PV module (for further information on calculating the insulation resistance see the Technical Information "Insulation Resistance (Riso) of Non-Galvanically Isolated PV Systems" at www.SMA-Solar.com).

Required devices:

- Suitable device for safe disconnection and short-circuiting
- Measuring device for insulation resistance

i Device required for safe disconnection and short-circuiting of the PV array

The insulation resistance can only be measured with a suitable device for safe disconnection and short-circuiting of the PV array. If no suitable device is available, the insulation measurement must not be carried out.

Procedure:

1. Calculate the expected insulation resistance per string.

2.

! DANGER

Danger to life due to high voltages

- Disconnect the inverter from all voltage sources (see Section 11, page 75).

3. Install the short circuit device.
4. Connect the measuring device for insulation resistance.
5. Short-circuit the first string.
6. Set the test voltage. The test voltage should be as close as possible to the maximum system voltage of the PV modules but must not exceed it (see datasheet of the PV modules).
7. Measure the insulation resistance.
8. Eliminate the short circuit.
9. Measure the remaining strings in the same manner.
 - ☑ If the insulation resistance of a string deviates considerably from the theoretically calculated value, there is a ground fault present in that string.
10. Reconnect to the inverter only those strings from which the ground fault has been eliminated.
11. Reconnect all other strings to the inverter.
12. Recommission the inverter.
13. If the inverter still displays an insulation error, contact the Service (see Section 16, page 90). The PV modules might not be suitable for the inverter in the present quantity.

10.5 Checking the Function of the Surge Arresters

⚠ QUALIFIED PERSON

Surge arresters are wearing parts. Their functionality diminishes with age or following repeated exposure to overvoltage. It is therefore possible for the surge arresters to lose their protective function over time.

Check the function of the surge arresters as described in the following.

Procedure:

1.

⚠ DANGER

Danger to life due to electric shock

- Disconnect the inverter from all voltage sources (see Section 11, page 75).
- Wait 20 minutes before removing the DC protective cover.

2. Release the screws on the DC protective cover using an Allen key (AF 3), lift the DC protective cover upwards from below and remove it.

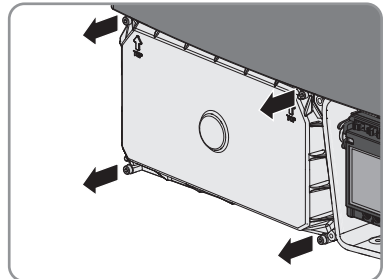

3. Check whether one of the surge arresters is defective.

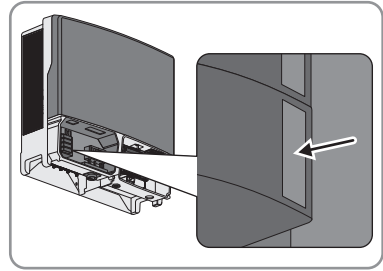

If no stripe is visible next to the type designation in the inspection window of the surge arrester, the surge arrester is in good condition.

If a red stripe is visible next to the type designation in the inspection window of the surge arrester, the surge arrester is defective.

- Order new surge arresters.
 - If new surge arresters are available, replace all surge arresters (see Section 10.6, page 72).
4. Tighten all four screws on the DC protective cover with an Allen key (AF 3) in the sequence 1 to 4 (torque: 3 Nm \pm 0.3 Nm).

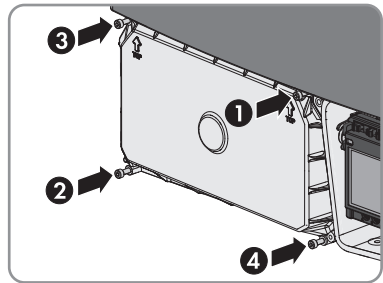

5. Recommission the inverter (see Section 7.3, page 40).

10.6 Replacing the Surge Arrester

⚠ QUALIFIED PERSON

If at least one surge arrester is defective, SMA Solar Technology AG recommends replacing all surge arresters.

Procedure:

1.

⚠ DANGER

Danger to life due to electric shock

- Disconnect the inverter from all voltage sources and open the lower enclosure lid (see Section 11, page 75).
- Wait 20 minutes before removing the DC protective cover.

2. Release the screws on the DC protective cover using an Allen key (AF 3), lift the DC protective cover upwards from below and remove it.

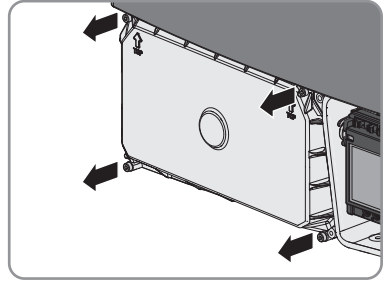

3. Pull all surge arresters out of the slots. To do so, squeeze the grooved areas on the left and right sides of the surge arrester.

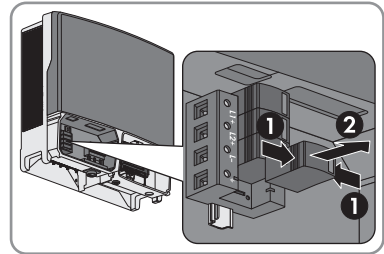

4. Remove the red protective ring from the middle contact on the bottom of each surge arrester.

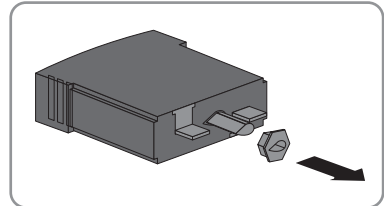

5. Plug the new surge arresters into the designated slots until they lock into place with the locking tabs. The inspection window on each surge arrester must face to the right.

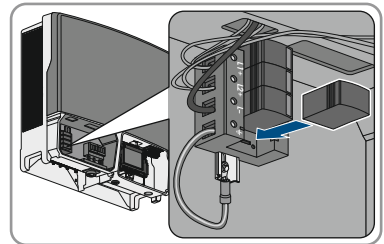

6. Ensure that each surge arrester is securely inserted into its slot.

7. Tighten all four screws on the DC protective cover with an Allen key (AF 3) in the sequence 1 to 4 (torque: $3 \text{ Nm} \pm 0.3 \text{ Nm}$).

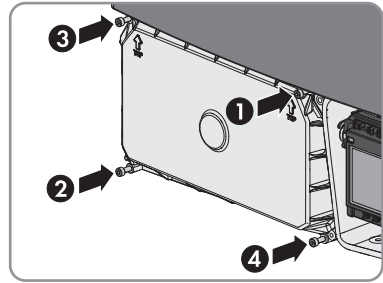

11 Disconnecting the Inverter from Voltage Sources

⚠ QUALIFIED PERSON

Prior to performing any work on the inverter, always disconnect it from all voltage sources as described in this section. Always adhere to the prescribed sequence.

⚠ WARNING

Danger to life due to electric shock from destruction of the measuring device due to overvoltage

Overvoltage can damage a measuring device and result in voltage being present in the enclosure of the measuring device. Touching the live enclosure of the measuring device results in death or lethal injuries due to electric shock.

- Only use measuring devices with a DC input voltage range of 1000 V or higher.

Procedure:

1. Disconnect the circuit breaker from all three line conductors and secure against reconnection.
2. If the multifunction relay is used, switch off any supply voltage to the load.
3. Turn the DC load-break switch to the position **O**.

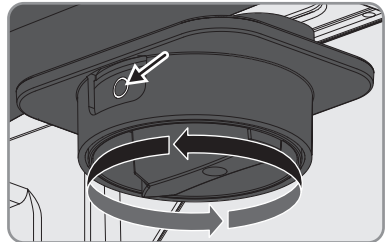

4. Wait until the LEDs have gone out and, if necessary, the load connected to the multifunction relay has been switched off.
5. Use a current clamp to ensure that no current is present in the DC cables.
6. Unscrew the two screws on the DC load-break switch using an Allen key (AF 3).

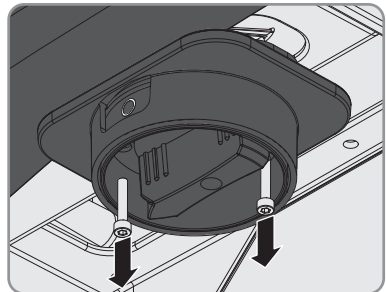

7. Pull the DC load-break switch down and out of the recess.

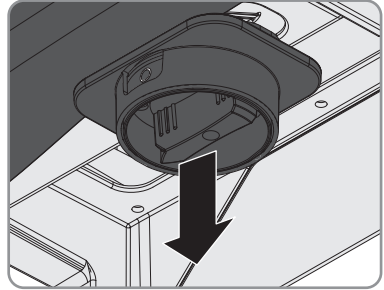

8. Remove all six screws from the lower enclosure lid using an Allen key (AF 3).

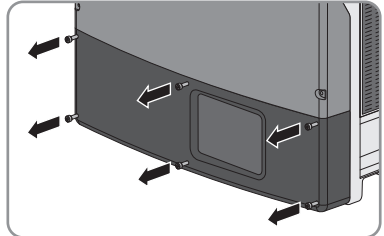

9. Lift and remove the lower enclosure lid from below.

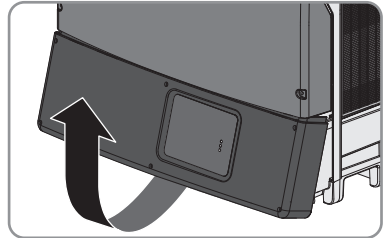

10.

⚠ CAUTION

Risk of burns when touching the DC protective cover

The DC protective cover can get hot during operation.

- Do not touch the DC protective cover.

11. Release and remove all DC connectors. Insert a slotted screwdriver or an angled screwdriver (blade width 3.5 mm) into one of the slide slots and pull the DC connectors out downwards. Do not pull on the cable.

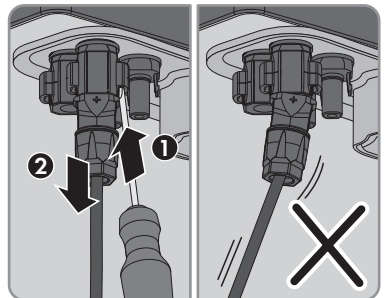

12. Ensure that no voltage is present at the DC inputs of the inverter.

13. If the neutral conductor is connected, use an appropriate multimeter to ensure that no voltage is present at the AC connecting terminal block between **L1** and **N**, **L2** and **N**, and **L3** and **N**. Insert the test probe of the multimeter into the round opening in the terminal.

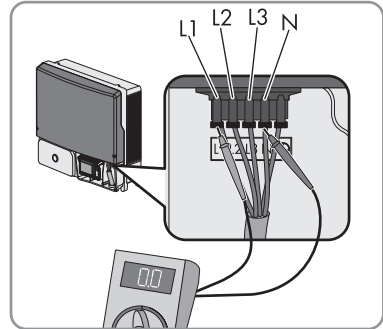

14. Use an appropriate measuring device to ensure that no voltage is present at the AC connecting terminal plate between **L1** and **PE**, **L2** and **PE**, and **L3** and **PE**. Insert the test probe into each round opening of the terminal.
15. Ensure that no voltage is present between any terminal of the multifunction relay and **PE** of the AC connecting terminal plate.

16.

⚠ DANGER

Danger to life due to high voltages in the inverter

The capacitors in the inverter take 20 minutes to discharge.

- Wait 20 minutes before opening the upper enclosure lid.
- Do not open the DC protective cover.

17.

NOTICE

Damage to the inverter due to electrostatic discharge

Touching electronic components can cause damage to or destroy the inverter through electrostatic discharge.

- Ground yourself before touching any component.

12 Procedure for Receiving a Replacement Device

Under fault conditions, the inverter may need to be replaced. If this is the case, you will receive a replacement device from SMA Solar Technology AG. If you received a replacement device, replace the defective inverter with the replacement device as described in this section.

Procedure:

- Decommission the defective inverter.
- Commission the replacement device.
- Ship the defective inverter.

Decommissioning the Defective Inverter

CAUTION

Risk of injury when lifting the inverter, or if it is dropped

The inverter weighs 61 kg. There is risk of injury if the inverter is lifted incorrectly or dropped while being transported or when attaching it to or removing it from the wall mounting bracket.

- Transport the inverter always as described below.

1.

DANGER

Danger to life due to electric shock

- Disconnect the inverter from all voltage sources (see Section 11, page 75).

2. Remove the AC cable from the inverter. Press the locking levers all the way upward and pull the conductors out of the terminal block for the AC cable.
3. Press down the locking levers of the terminal block for the AC cable.
4. Remove the cable for the additional grounding from the grounding terminal, if necessary.
5. If the multi-function relay or the SMA Power Control Module are used, remove the connection cable from the inverter.
6. If other cables (e.g. data cables or network cables) are connected, remove them from the inverter.
7. Remove any installed interfaces from the inverter (see the manual for the communication interface).
8. If surge arresters are present, remove the surge arresters from the defective inverter (see Section 10.6, page 72).
9. Close all enclosure openings.
10. Keep the DC load-break switch in a safe place as the replacement device will be delivered without the DC load-break switch.

11.

⚠ CAUTION**Risk of burns due to hot enclosure parts**

- Wait 30 minutes before disassembling the inverter. This will allow the enclosure to cool down and thus prevent burn injuries.

12. Remove the inverter by lifting it vertically up and off the wall mounting bracket.

Commissioning the Replacement Device**NOTICE****Damage to the enclosure seal in subfreezing conditions**

If you open the product when temperatures are below freezing, the enclosure seals can be damaged. Moisture can penetrate the product and damage it.

- Only open the product if the ambient temperature is not below -5°C .
- If a layer of ice has formed on the enclosure seal when temperatures are below freezing, remove it prior to opening the product (e.g. by melting the ice with warm air). Observe the applicable safety regulations.

NOTICE**Damage to the inverter due to electrostatic discharge**

Touching electronic components can cause damage to or destroy the inverter through electrostatic discharge.

- Ground yourself before touching any component.

1. Mount the replacement device and make the electrical connections (see the operating manual of the inverter).
2. If needed, install interfaces in the replacement device and connect the interfaces (see the interface manual).
3. If needed, install a surge arrester in the replacement device (see Section 6.4 "Retrofitting the Surge Arrester Type II", page 32).
4. If there is a label with "transport lid" affixed to the upper lid of the replacement device, replace the upper enclosure lid of the replacement device with the upper enclosure lid of the defective inverter.

⚠ DANGER**Danger to life due to high voltages**

Wait 20 minutes before removing the upper enclosure lid to allow residual voltages to discharge.

- Loosen the screws of the upper enclosure lid using an Allen key (AF 4) and remove the enclosure lid.

- Position the upper enclosure lid with the six screws and conical spring washers on the enclosure and tighten it using an Allen key (AF 4) in the order 1 to 6 (torque: $6 \text{ Nm} \pm 0.3 \text{ Nm}$).

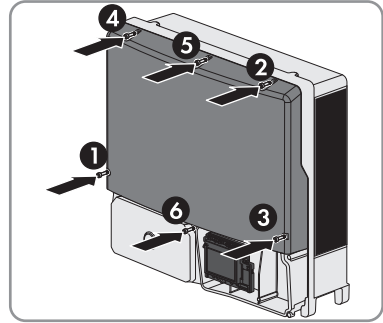

5. Insert the lower enclosure lid from above and flip it down. Use the enclosure lid of the defective inverter for this if there is a label with "transport lid" affixed to the enclosure lid of the replacement device. The screws must protrude from the lower enclosure lid.

6. Tighten all six screws of the lower enclosure lid using an Allen key (AF3) in the order 1 to 6 (torque: $2.0 \text{ Nm} \pm 0.3 \text{ Nm}$). By tightening the screws in the prescribed order, you avoid warping the lid, which would keep it from sealing correctly. Tip: If the screws fall out of the lower enclosure lid, insert the long screw into the lower middle hole and the five short screws into the other holes.

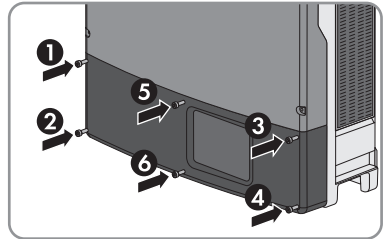

7. Recommission the replacement device (see Section 7.3, page 40). Remount the DC load-break switch of the defective inverter to the replacement device.
 8. Configure the replacement device (see the operating manual of the inverter).
 9. Replace the replacement device in the communication product.

Shipping the Defective Inverter

1. If necessary, position the upper enclosure lid with the six screws and conical spring washers on the enclosure and tighten it using an Allen key (AF4) in the order 1 to 6 (torque: $6 \text{ Nm} \pm 0.3 \text{ Nm}$).

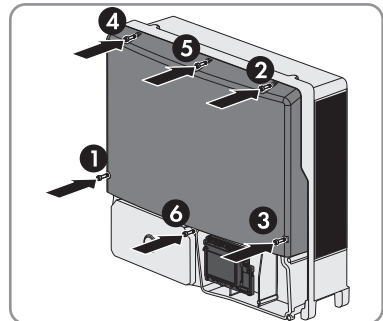

2. Insert the lower enclosure lid from above and flip it down. The screws must protrude from the lower enclosure lid.

3. Tighten all six screws of the lower enclosure lid using an Allen key (AF3) in the order 1 to 6 (torque: $2.0 \text{ Nm} \pm 0.3 \text{ Nm}$). By tightening the screws in the prescribed order, you avoid warping the lid, which would keep it from sealing correctly. Tip: If the screws fall out of the lower enclosure lid, insert the long screw into the lower middle hole and the five short screws into the other holes.

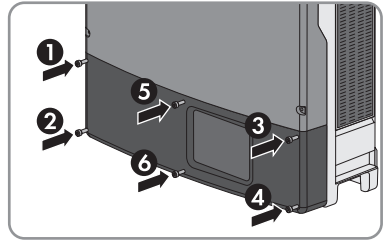

4. Pack the defective inverter in the packaging of the replacement device and arrange with SMA Solar Technology AG for it to be picked up.

13 Decommissioning the Inverter

⚠ QUALIFIED PERSON

To decommission the inverter completely upon completion of its service life, proceed as described in this Section. If the inverter is defective and you have received a replacement device, observe the information on how to proceed when receiving a replacement device (see Section 12 "Procedure for Receiving a Replacement Device", page 78).

⚠ CAUTION

Risk of injury when lifting the inverter, or if it is dropped

The inverter weighs 61 kg. There is risk of injury if the inverter is lifted incorrectly or dropped while being transported or when attaching it to or removing it from the wall mounting bracket.

- Transport the inverter always as described below.

Procedure:

1.

⚠ DANGER

Danger to life due to high voltages

- Disconnect the inverter from all voltage sources (see Section 11, page 75).

- Remove the AC cable from the inverter. Press the locking levers all the way upward and pull the conductors out of the terminal block for the AC cable.
- Press down the locking levers of the terminal block for the AC cable.
- If the multi-function relay or the SMA Power Control Module are used, remove the connection cable from the inverter.
- If other cables (e.g. data cables or network cables) are connected, remove them from the inverter.
- Insert the lower enclosure lid from above and flip it down. The screws must protrude from the lower enclosure lid.

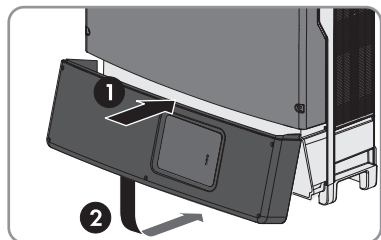

- Tighten all six screws with an Allen key (AF 3) in the order 1 to 6 (torque: 2.0 Nm \pm 0.3 Nm). By tightening the screws in the prescribed order, you avoid warping the lid, which would keep it from sealing correctly. Tip: If the screws fall out of the lower enclosure lid, insert the long screw into the lower middle hole and the five short screws into the other holes.

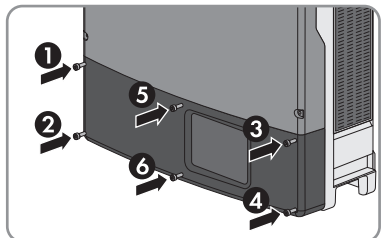

8.

⚠ CAUTION**Risk of burns due to hot enclosure parts**

- Wait 30 minutes for the enclosure to cool down.

9. If the inverter is protected from being lifted off, unscrew the screws out of the lower drill holes in the rear panel of the inverter.
10. Remove the inverter by lifting it up and off the wall mounting bracket.
11. If the inverter is to be stored or shipped in packaging, pack the inverter, the wall mounting bracket and, if applicable, the DC load-break switch. Use the original packaging or packaging that is suitable for the weight and dimensions of the inverter.
12. Dispose of the inverter in accordance with the locally applicable disposal regulations for electronic waste.

14 Technical Data

DC Input

	STP 15000TL-30	STP 17000TL-30	STP 20000TL-30	STP 25000TL-30
Maximum DC power at $\cos \varphi = 1$	15330 W	17374 W	20440 W	25550 W
Maximum input voltage	1000 V	1000 V	1000 V	1000 V
MPP voltage range	240V to 800 V	275 V to 800 V	320 V to 800 V	390 V to 800 V
Rated input voltage	600 V	600 V	600 V	600 V
Minimum input voltage	150 V	150 V	150 V	150 V
Initial input voltage	188 V	188 V	188 V	188 V
Maximum input current, input A	33 A	33 A	33 A	33 A
Maximum input current, input B	33 A	33 A	33 A	33 A
Maximum short-circuit current per string*	43 A	43 A	43 A	43 A
Maximum reverse current in the system for max. 1 ms	0 A	0 A	0 A	0 A
Number of independent MPP inputs	2	2	2	2
Strings per MPP input	3	3	3	3
Surge category in accordance with IEC 62109-1	II	II	II	II

* In accordance with IEC 62109-2: I_{SCPV}

AC Output

	STP 15000TL-30	STP 17000TL-30	STP 20000TL-30	STP 25000TL-30
Rated power at 230 V, 50 Hz	15000 W	17000 W	20000 W	25000 W
Maximum apparent AC power	15000 VA	17000 VA	20000 VA	25000 VA
Rated grid voltage	230 V	230 V	230 V	230 V
Nominal AC voltage	220 V / 230 V / 240 V	220 V / 230 V / 240 V	220 V / 230 V / 240 V	220 V / 230 V / 240 V
AC voltage range*	180 V to 280 V	160 V to 280 V	180 V to 280 V	180 V to 280 V
Nominal AC current at 230 V	21.7 A	24.6 A	29 A	36.2 A
Maximum output current	29 A	29 A	29 A	36.2 A
Maximum output current under fault conditions	50 A	50 A	50 A	50 A
Total harmonic distortion of the output current with total harmonic distortion of the AC voltage <2%, and AC power >50% of the rated power	≤3%	≤2.6%	≤3%	≤3%
Rated power frequency	50 Hz	50 Hz	50 Hz	50 Hz
AC power frequency*	50 Hz / 60 Hz	50 Hz / 60 Hz	50 Hz / 60 Hz	50 Hz / 60 Hz
Operating range at AC power frequency 50 Hz	44 Hz to 55 Hz	44 Hz to 55 Hz	44 Hz to 55 Hz	44 Hz to 55 Hz
Operating range at AC power frequency 60 Hz	54 Hz to 65 Hz	54 Hz to 65 Hz	54 Hz to 65 Hz	54 Hz to 65 Hz
Power factor at rated power	1	1	1	1

	STP 15000TL-30	STP 17000TL-30	STP 20000TL-30	STP 25000TL-30
Displacement power factor, adjustable	$O_{\text{overexcited}}$ to $O_{\text{underexcited}}$	$O_{\text{overexcited}}$ to $O_{\text{underexcited}}$	$O_{\text{overexcited}}$ to $O_{\text{underexcited}}$	$O_{\text{overexcited}}$ to $O_{\text{underexcited}}$
Feed-in phases	3	3	3	3
Phase connection	3	3	3	3
Surge category in accordance with IEC 62109-1	III	III	III	III

* Depending on the configured country data set

Efficiency

	STP 15000TL-30	STP 17000TL-30	STP 20000TL-30	STP 25000TL-30
Maximum efficiency, η_{max}	98.4%	98.4%*	98.4%	98.3%
European weighted efficiency, η_{EU}	98.0%	98.0%*	98.0%	98.1%

* Preliminary value

Protective Devices

DC reverse polarity protection	Short-circuit diode
Input-side disconnection point	DC Load-Break Switch
DC surge protection	Surge arrester type II (optional)
AC short-circuit current capability	Current control
Grid monitoring	SMA Grid Guard 10.0
Maximum overcurrent protection	50 A
Ground fault monitoring	Insulation monitoring: $R_{\text{iso}} > 250 \text{ k}\Omega$
All-pole sensitive residual-current monitoring unit	Available

General Data

Width x height x depth, with DC load-break switch plugged in	661 mm x 682 mm x 264 mm
Weight	61 kg
Length x width x height of the packaging	780 mm x 380 mm x 790 mm
Transport weight	68 kg

Climatic category in accordance with IEC 60721-3-4	4K4H
Environmental category	Outdoors
Pollution degree outside the enclosure	3
Pollution degree inside the enclosure	2
Operating temperature range	-25 °C to +60 °C
Maximum permissible value for relative humidity, non-condensing	100%
Maximum operating altitude above mean sea level (MSL)	3000 m
Typical noise emission	51 dB(A)
Power loss in night mode	1 W
Topology	Transformerless
Cooling method	SMA OptiCool
Degree of protection for electronics in accordance with IEC 60529	IP65
Protection class in accordance with IEC 62109-1	I
Grid configurations	TN-C, TN-S, TN-C-S, TT (when $V_{N,PE} < 20$ V)

Climatic Conditions

Installation in accordance with IEC 60721-3-4, Class 4K4H

Extended temperature range	-25 °C to +60 °C
Extended humidity range	0% to 100%
Threshold for relative humidity, non-condensing	100%
Extended air pressure range	79.5 kPa to 106 kPa

Transport in accordance with IEC 60721-3-4, Class 2K3

Temperature range	-25 °C to +70 °C
-------------------	------------------

Equipment

DC connection	SUNCLIX DC connector
AC terminal	Spring-cage terminal
Speedwire/Webconnect Data Module	As standard
RS485, galvanically isolated	Optional

Multifunction relay	Optional
SMA Power Control Module	Optional
Surge arrester type II	Optional

Fans

Width x height x depth	60 mm x 60 mm x 25.4 mm
Noise emission, typical	≤29 dB(A)
Maximum operating altitude	3000 m
Air flow rate	≥ 40 m ³ /h

Torques

Upper lid screws	6 Nm ± 0.3 Nm
Screws lower lid	2 Nm ± 0.3 Nm
Screws for DC protective cover	3.5 Nm
Screw for additional grounding	5.8 Nm
SUNCLIX swivel nut	2 Nm

Data Storage Capacity

Daily energy yields	63 days
Daily yields	30 years
Event messages for users	250 events
Event messages for installers	250 events

15 Spare Parts and Accessories

You will find the corresponding accessories and spare parts for your product in the following overview. If required, these can be ordered from SMA Solar Technology AG or your distributor.

Designation	Brief description	SMA order number
RS485 data module	RS485 interface as retrofit kit	DM-485CB-10
SMA Power Control Module	Multifunction interface for implementing grid management systems for one inverter	PWCMOD-10
Multifunction relay	Multifunction relay as retrofit kit	MFR01-10
Surge arrester type II	Type II surge arrester for input A and input B	DC_SPD_KIT3-10
SUNCLIX DC connector	Field plug for conductor cross-sections of 2.5 mm ² to 6 mm ²	SUNCLIX-FC6-SET
Ventilation grid	Ventilation grid set (right and left) as spare part	45-10899080

16 Contact

If you have technical problems with our products, please contact the SMA Service Line. The following data is required in order to provide you with the necessary assistance:

If you have technical problems concerning our products, contact your service partner. The following data is required in order to provide you with the necessary assistance:

- Device type
- Serial number
- Firmware version
- Event message
- Mounting location and mounting height
- Type and number of PV modules
- Optional equipment, e.g. communication products
- Use the name of the system in Sunny Portal (if available)
- Access data for Sunny Portal (if available)
- Special country-specific settings (if available)
- Operating mode of the multifunction relay (if present)

Deutschland	SMA Solar Technology AG	Belgien	SMA Benelux BVBA/SPRL
Österreich	Niestetal	Belgique	Mechelen
Schweiz	Sunny Boy, Sunny Mini Central, Sunny Tripower, Sunny High- power: +49 561 9522-1499 Monitoring Systems (Kommunikationsprodukte): +49 561 9522-2499 Hybrid Controller: +49 561 9522-3199 Sunny Island, Sunny Boy Stor- age, Sunny Backup: +49 561 9522-399 Sunny Central, Sunny Central Storage: +49 561 9522-299 SMA Online Service Center: www.SMA-Service.com	België	+32 15 286 730
		Luxemburg	for Netherlands: +31 30 2492 000
		Luxembourg	
		Nederland	SMA Online Service Center: www.SMA-Service.com
		Česko	SMA Service Partner TERMS a.s.
		Magyarország	+420 387 6 85 111
		Slovensko	SMA Online Service Center: www.SMA-Service.com
		Türkiye	SMA Service Partner DEKOM Ltd. Şti. +90 24 22430605 SMA Online Service Center: www.SMA-Service.com
France	SMA France S.A.S. Lyon +33 472 22 97 00 SMA Online Service Center : www.SMA-Service.com	Ελλάδα	SMA Service Partner AKTOR FM. Αθήνα +30 210 8184550 SMA Online Service Center: www.SMA-Service.com
		Κύπρος	

España Portugal	SMA Ibérica Tecnología Solar, S.L.U. Barcelona +34 935 63 50 99 SMA Online Service Center: www.SMA-Service.com	United King- dom	SMA Solar UK Ltd. Milton Keynes +44 1908 304899 SMA Online Service Center: www.SMA-Service.com
Italia	SMA Italia S.r.l. Milano +39 02 8934-7299 SMA Online Service Center: www.SMA-Service.com	Australia	SMA Australia Pty Ltd. Sydney Toll free for Australia: 1800 SMA AUS (1800 762 287) International: +61 2 9491 4200
United Arab Emirates	SMA Middle East LLC Abu Dhabi +971 2234 6177 SMA Online Service Center: www.SMA-Service.com	India	SMA Solar India Pvt. Ltd. Mumbai +91 22 61713888
ไทย	SMA Solar (Thailand) Co., Ltd. กรุงเทพฯ +66 2 670 6999	대한민국	SMA Technology Korea Co., Ltd. 서울 +82-2-520-2666
South Africa	SMA Solar Technology South Africa Pty Ltd. Cape Town 08600SUNNY (08600 78669) International: +27 (0)21 826 0699 SMA Online Service Center: www.SMA-Service.com	Argentina Brasil Chile Perú	SMA South America SPA Santiago de Chile +562 2820 2101
Other coun- tries	International SMA Service Line Niestetal 00800 SMA SERVICE (+800 762 7378423) SMA Online Service Center: www.SMA-Service.com		

17 EU Declaration of Conformity

within the scope of the EU directives

- Electromagnetic compatibility 2014/30/EU (29.3.2014 L 96/79-106) (EMC)
- Low Voltage Directive 2014/35/EU (29.3.2014 L 96/357-374) (LVD)
- Restriction of the use of certain hazardous substances 2011/65/EU (L 174/88, June 8, 2011) and 2015/863/EU (L 137/10, March 31, 2015) (RoHS)



SMA Solar Technology AG confirms herewith that the products described in this document are in compliance with the fundamental requirements and other relevant provisions of the above-mentioned directives. The entire EU Declaration of Conformity can be found at www.SMA-Solar.com.

