

## HERU 100 T EC



### HERU@100 T EC

- Wall-mounted model with top connection.
- Designed for supply and exhaust air ventilation with energy recovery.
- Suitable for installation in apartments, small houses, offices and other premises where there are stringent requirements on the indoor environment.
- High temperature efficiency 86%, low energy consumption (SFP), low sound level, high operating reliability and provides clean indoor air.
- Unique design minimizes all thermal bridges.
- For easy handling, the unit is remote-controlled using the wireless control unit for operation and monitoring.
- Comes prepared for Modbus communication via RS485 (accessory needed).
- Airflow is generated by two silent radial fans with EC motors and impellers with backward curved blades.
- The fans are connected with quick connectors and are very easy to remove for cleaning.
- A regenerative, non-hygroscopic, aluminum rotating heat exchanger located in the center of the unit. The heat exchanger can also be removed for cleaning.
- Incinerable panel filter ISO ePM1 50% as standard, for both exhaust and supply air. The filter is very easy to change.
- Integrated controls for heating/cooling.
- Available with or without integrated electric heater.
- The unit is constructed of galvanized steel sheet, partially painted white, and insulated.
- For placement in warm areas, such as laundry, storage or utility rooms.
- Available in either right-hand or left-hand design. Can be ordered with a connection for a cooker hood. This connection is routed past the rotor to prevent cooking odours from spreading back into the premises.
- Equipped with wall plug.
- Integrated silencer on the supply air and extract air side.

### NOTE!

**The warranty of The HERU@ is only valid if accessories/equipment (e.g. filters) from H. Östberg AB are used.**

## DIAGRAMS

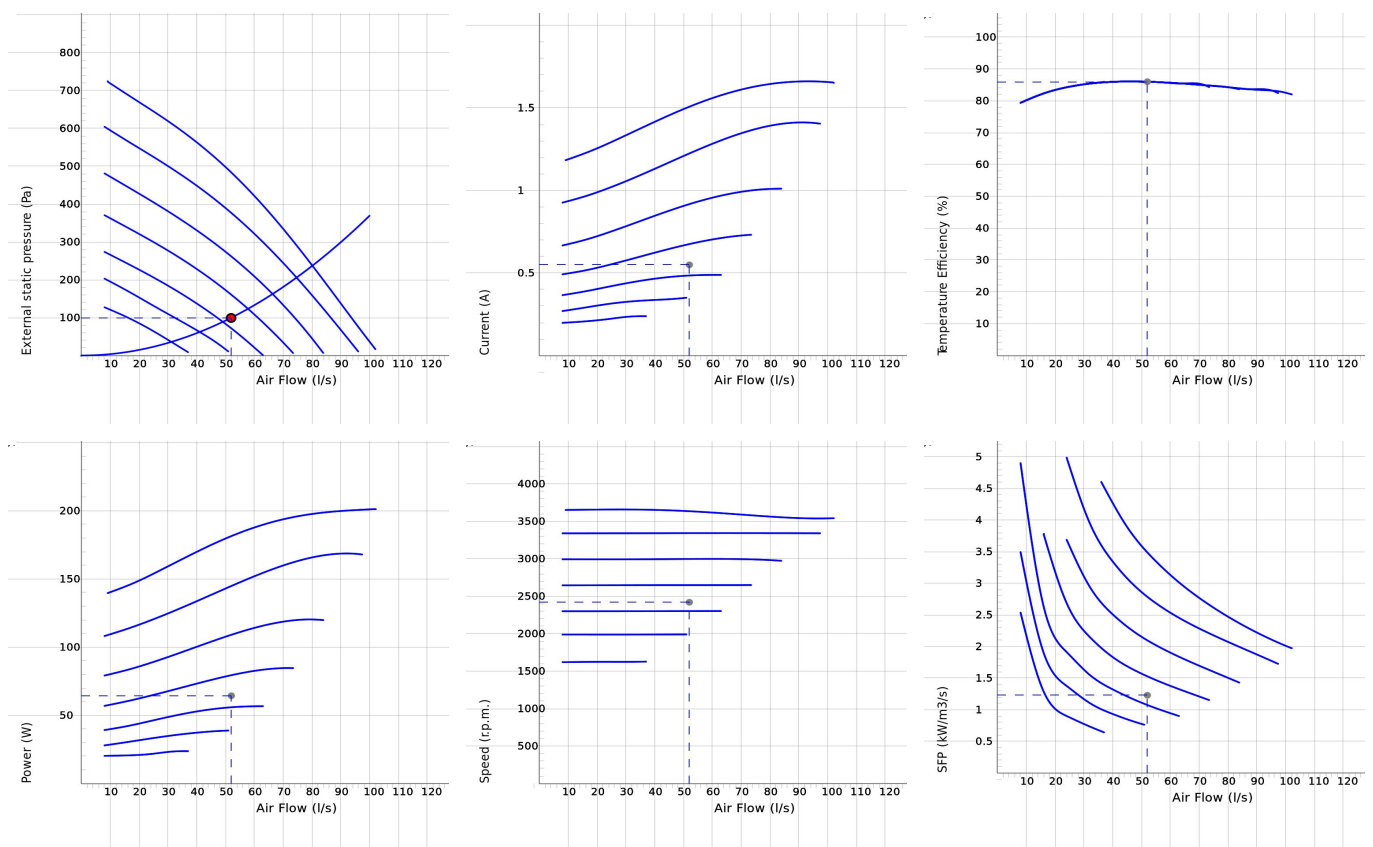

## Work Point

Air Flow (l/s)	External static pressure (Pa)	Power (W)	Speed (r.p.m.)	Current (A)	Efficiency (%)	SFP (kW/m <sup>3</sup> /s)	Voltage (V)
52	100	64.4	2419	0.549	86	1.23	6.34

## SOUND DATA

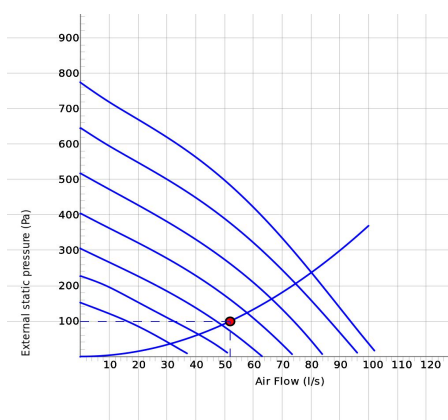

	Tot	63	125	250	500	1k	2k	4k	8k
Supply Lw dB(A)	62	52	57	56	53	44	46	41	34
Extract Lw dB(A)	53	48	47	45	45	45	35	28	17
Surrounding Lw dB(A)	40	25	36	36	26	26	25	27	29
Surrounding Lp dB (A) 3m	33	18	29	29	19	19	18	20	22

## Work Point

Air Flow (l/s) 52	External static pressure (Pa) 100	Power (W) 64.4	Speed (r.p.m.) 2419	Current (A) 0.549	Efficiency (%) 86	SFP (kW/m3/s) 1.23	Voltage (V) 6.34
----------------------	--------------------------------------	-------------------	------------------------	----------------------	----------------------	-----------------------	---------------------

## TECHNICAL DATA

Parameter	HERU 100 T EC AR 1200W 8010724		HERU 100 T EC AL 1200W 8010725		HERU 100 T EC ARC 1200W 8010726		HERU 100 T EC ALC 1200W 8010727		HERU 100 T EC BL 600W 8010728		HERU 100 T EC BR 600W 8010731	
	Value	Unit	Value	Unit	Value	Unit	Value	Unit	Value	Unit	Value	Unit
Voltage	230	V	230	V	230	V	230	V	230	V	230	V
Phase	1	-	1	-	1	-	1	-	1	-	1	-
Frequency	50	Hz	50	Hz	50	Hz	50	Hz	50	Hz	50	Hz
Power	1430	W	1430	W	1430	W	1430	W	830	W	830	W
Power, fans	203	W	203	W	203	W	203	W	203	W	203	W
Power, heater	1200	W	1200	W	1200	W	1200	W	600	W	600	W
Current	7	A	7	A	7	A	7	A	4.4	A	4.4	A
Current, fans	1.65	A	1.65	A	1.65	A	1.65	A	1.65	A	1.65	A
Current, heater	5.22	A	5.22	A	5.22	A	5.22	A	2.61	A	2.61	A
Speed	3550	r.p.m.	3550	r.p.m.	3550	r.p.m.	3550	r.p.m.	3550	r.p.m.	3550	r.p.m.
Sound pressure level at 3 m	39	dB(A)	39	dB(A)	39	dB(A)	39	dB(A)	39	dB(A)	39	dB(A)
Weight	65	kg	65	kg	65	kg	65	kg	65	kg	65	kg
Enclosure class	41	IP	41	IP	41	IP	41	IP	41	IP	41	IP
Duct connection	125	mm	125	mm	125	mm	125	mm	125	mm	125	mm
Max. flow	104	l/s	104	l/s	104	l/s	104	l/s	104	l/s	104	l/s
Max. pressure	772	Pa	772	Pa	772	Pa	772	Pa	772	Pa	772	Pa
Voltage range	220-240	V	220-240	V	220-240	V	220-240	V	220-240	V	220-240	V

## ECODESIGN

Parameter	Value	Unit
(a) Manufacturer	Östberg	-
(b) Model code	HERU 100 T EC	-
(c) SEC value	-39.42	kWh/m <sup>2</sup>
SEC class	A	-
(d) Declared type	RVU / BVU	-
(e) Type of drive	Variable speed drive	-
(f) Type of heat recovery	Regenerative	-
(g) Thermal efficiency	85	%
(h) Max. flow rate (@100Pa)	337	m <sup>3</sup> /h
(i) Power at max. flow rate	200	W
(j) Sound power level	41	dB LwA
(k) Reference flow rate	0.068	m <sup>3</sup> /s
(l) Reference pressure difference	50	Pa
(m) SPI	0.46	W/(m <sup>3</sup> /h)
(n) Type of control	Local demand control	-
(o) External (and internal) leakage rate	1.16 (2.93)	%
(p) Mixing rate	N/A	-
(q) Visual filter warning	In remote control	-
(r) Instruction supply/exhaust grilles	N/A	-
(s) Disassembly instructions	<a href="http://www.ostberg.com">www.ostberg.com</a>	-
(t) Airflow sensitivity	N/A	-
(u) Air tightness	N/A	m/s
(v) AEC	286	kWh
(w) AHS average	4618	kWh
AHS warmer	2088	kWh
AHS colder	9034	kWh

## WIRING DIAGRAM

4040182

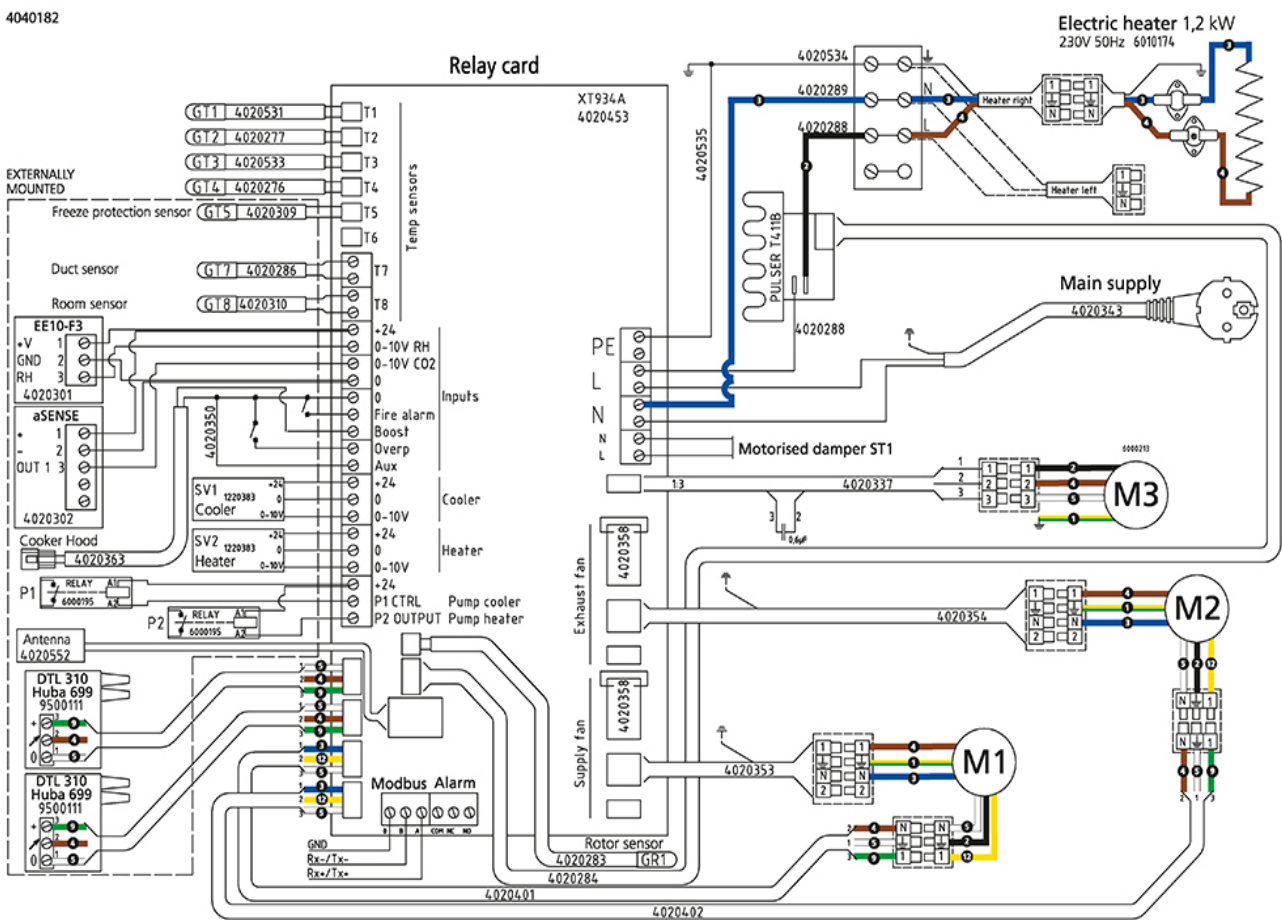

## DIMENSIONS

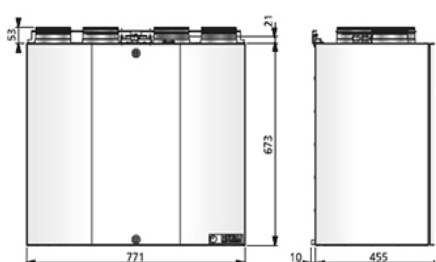

RIGHT-HAND DESIGN

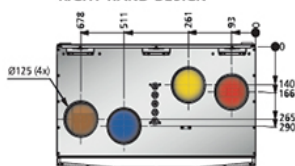

RIGHT-HAND DESIGN with cooker hood connection

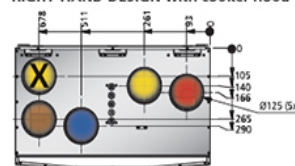

LEFT-HAND DESIGN

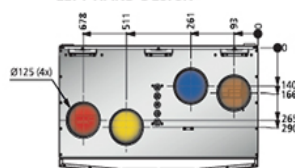

LEFT-HAND DESIGN with cooker hood connection

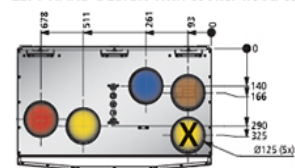

### ENGLISH

- Supply air
- Extract air
- Exhaust air
- Fresh air
- ⊗ Cooker hood

### SVENSKA

- Tilluft
- Frånluft
- Avluft
- Uteluft
- ⊗ Spiskåpa

### DEUTSCH

- Zuluft
- Abluft
- Fortluft
- Frischluft
- ⊗ Dunstabzugshaube

### SUOMI

- Tuloilma
- Poistoilma
- Jäteilma
- Ulkoilma
- ⊗ Liesituuletin

### ITALIANO

- Aria di immissione
- Aria di estrazione
- Sfiato
- Aria esterna
- ⊗ Cappa cucina

### POLSKI

- Powietrze nawiew
- Powietrze wywiew
- Powietrze usuwane
- Powietrze z zewnątrz
- ⊗ Okapu kuchennego

## ACCESSORIES

### Electrical accessories



Humidity sensor RH



Carbon dioxide  
sensor CO2



Room sensor



Pressure Sensor Kit



Heater Kit Water,  
HERU  
62/70/90/95/100T,  
50/90LP



Control Kit



Remote control



Remote control with  
Modbus



Control board



Antenna



Extension cable,  
antenna



Freeze protection  
sensor



Duct sensor



Damper motor



Relay pump control

### Mechanical accessories



Outside wall hood  
160



Ceiling Mounting  
Plate



Filter Kit HERU  
70/100 T



Silencer LDC 125