

PRODUCT FAMILY DATASHEET

FLOODLIGHT SENSOR 20

Luminaire with symmetrical light output with 20 W and sensor



AREAS OF APPLICATION

- Replacement for floodlights with halogen lamps
- Car parks and underpasses
- Garages
- Public areas
- Construction areas
- D-sign according to EN 60598-2-24 for fire-risk commercial unit, f. e. by accumulation of dust

PRODUCT BENEFITS

- Energy savings of up to 90 % compared to halogen lamp floodlights
- Frosted cover made of tempered glass for uniform illumination
- Easy adjustment of range, daylight and motion detection via rotary switch
- 3 years guarantee

PRODUCT FEATURES

- Luminaire efficacy: up to 110 lm/W
- Symmetrical beam angle: 100° x 100°
- PIR motion and daylight sensor
- Deactivation of the sensor by switch setting
- Mounting bracket for up to 180° tilting
- Type of protection: IP65
- Impact resistance: IK07
- Ambient temperature in operation: -20...+40 °C



- Connection via 1 m cable, wiring required

TECHNICAL DATA

Product description	Electrical data			Photometrical data			Light technical data	Luminaire sensor data	Dimensions & weight		
	Nominal wattage	Nominal voltage	Mains frequency	Luminous flux	Light color (designation)	Color rendering index Ra	Beam angle	Type of sensor	Length	Width	Height
FLOODLIGHT 20 W 3000 K IP65 BK S ¹⁾	20.00 W	220...240 V	50/60 Hz	2200 lm	Warm White	≥80	100 ° x 100 °	Motion / Light	223.5 mm	167.0 mm	104.0 mm
FLOODLIGHT 20 W 4000 K IP65 BK S ¹⁾	20.00 W	220...240 V	50/60 Hz	2200 lm	Cool White	≥80	100 ° x 100 °	Motion / Light	223.5 mm	167.0 mm	104.0 mm

Product description	Product weight	Colors & materials			Temperatures & operating conditions	Lifespan		
		Body material	Product color	Cover material	Ambient temperature range	Lifespan L70 at 25 °C	Lifespan L80 at 25 °C	Lifespan L90 at 25 °C
FLOODLIGHT 20 W 3000 K IP65 BK S ¹⁾	560.00 g	Polycarbonate (PC)	Black	TEMPERED GLASS	-20...40 °C	50000 h	30000 h	15000 h
FLOODLIGHT 20 W 4000 K IP65 BK S ¹⁾	560.00 g	Polycarbonate (PC)	Black	TEMPERED GLASS	-20...40 °C	50000 h	30000 h	15000 h

Product description	Capabilities		Certificates & standards	
	Dimmable	Type of connection	Protection class	Type of protection
FLOODLIGHT 20 W 3000 K IP65 BK S ¹⁾	No	Cable, 3-pole	I	IP65
FLOODLIGHT 20 W 4000 K IP65 BK S ¹⁾	No	Cable, 3-pole	I	IP65

¹⁾ Available from July 2018

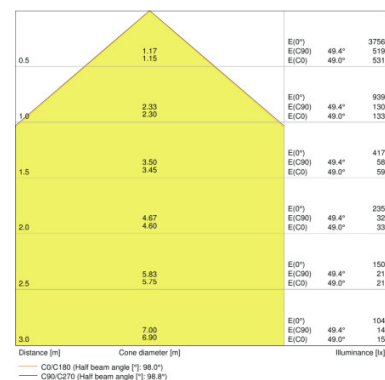
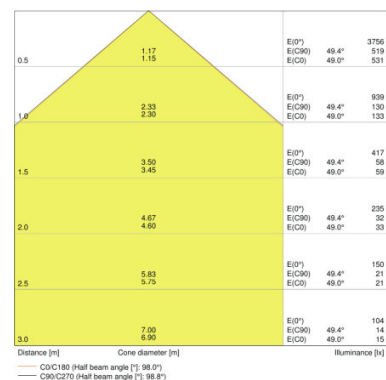
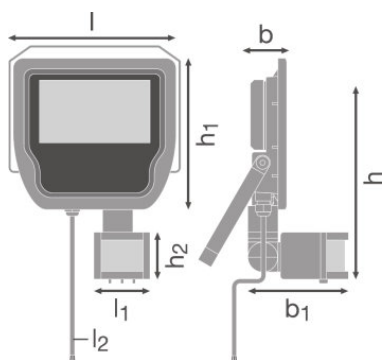

FLOODLIGHT 20 W 3000 K IP65 BK S,
 FLOODLIGHT 20 W 4000 K IP65 BK S

FLOODLIGHT 20 W 3000 K IP65 BK S

FLOODLIGHT 20 W 4000 K IP65 BK S

APPLICATION ADVICE

For more detailed application information and graphics please see product datasheet.

LOGISTICAL DATA

Product code	Product description	Packaging unit (Pieces/Unit)	Dimensions (length x width x height)	Volume	Gross weight
4058075143531	FLOODLIGHT 20 W 3000 K IP65 BK S	Shipping carton box 10	388 mm x 347 mm x 275 mm	37.02 dm ³	6780.00 g
4058075143555	FLOODLIGHT 20 W 4000 K IP65 BK S	Shipping carton box 10	388 mm x 347 mm x 275 mm	37.02 dm ³	6780.00 g

The mentioned product code describes the smallest quantity unit which can be ordered. One shipping unit can contain one or more single products. When placing an order, for the quantity please enter single or multiples of a shipping unit.

REFERENCES / LINKS

For Guarantee see

▶ www.ledvance.com/guarantee

DISCLAIMER

Subject to change without notice. Errors and omission excepted. Always make sure to use the most recent release.