



# AVT air velocity transmitter

USER GUIDE



# Contents

- 1 Introduction..... 3**
  - 1.1 About this user guide.....3
  - 1.2 Intended use.....3
- 2 Safety precautions..... 4**
- 3 Main components..... 5**
- 4 Commissioning..... 6**
  - 4.1 Setting the jumpers.....6
    - 4.1.1 Selecting the measurement range.....6
    - 4.1.2 Selecting the output mode.....6
    - 4.1.3 Terminating Modbus (-MOD models).....7
  - 4.2 Mounting the product.....7
  - 4.3 Wiring.....9
    - 4.3.1 Wiring for Modbus models (-MOD).....10
  - 4.4 Warm-up mode.....11
  - 4.5 Configuring settings via device menu.....11
    - 4.5.1 Available settings for velocity and temperature.....13
    - 4.5.2 Relay settings.....16
    - 4.5.3 The Exit menu view.....16
    - 4.5.4 Available settings for Modbus.....16
  - 4.6 Configuring settings using Produal MyTool® application.....17
    - 4.6.1 Configuring measurement settings.....20
    - 4.6.2 Configuring communication settings.....22
    - 4.6.3 Saving and loading the configuration.....23
    - 4.6.4 Resetting device settings to defaults.....24
  - 4.7 Locking the cover.....24
- 5 Maintenance..... 26**
  - 5.1 Cleaning the probe and the sensor element.....26
- 6 Modbus..... 27**
  - 6.1 Modbus properties.....27
  - 6.2 Modbus function codes.....27
  - 6.3 Modbus registers.....27
    - 6.3.1 Input registers.....27
    - 6.3.2 Holding registers.....29
- 7 Disposal..... 31**

# 1 Introduction

Thank you for choosing an AVT air velocity transmitter. It is an air velocity and temperature transmitter for ventilation ducts. The AVT air velocity transmitter is available with several options:

- The -BT models have a PID controller for air velocity and MyTool® Connect connection.
- The -D models have a PID controller for air velocity and a display that shows air velocity and temperature measurement values.
- The -MOD models have an RS-485 connection for Modbus RTU communication.
- The -R models include a relay and a relay connector.

The -MOD models have Modbus communication instead of analogue outputs. Other models have one analogue air velocity output and one analogue temperature output. You can select the output signal mode and measurement range for the analogue outputs during commissioning. The available output signal modes are voltage (Vdc) and current (mA).

Devices without the -D or -BT option have three field selectable measurement ranges for air velocity. The measurement unit is *m/s*. You can select the air velocity measurement range with jumpers. The measurement unit for temperature is Celsius.

The -D and -BT models provide a freely selectable measurement range for air velocity. The available measurement units are *m/s* and *ft/min*. You can select the measurement range via the device menu (-D models) or using a MyTool® Connect dongle and the Produal MyTool® smartphone application (-BT models). The available measurement units for temperature are Celsius and Fahrenheit.

You can configure the device settings using:

- the device menu (-D models)
- Modbus communication (-MOD models)
- the MyTool® Connect dongle and Produal MyTool® smartphone application (-BT models)

## 1.1 About this user guide

This user guide contains important information about the installation, wiring, configuration and use of the product. Read this guide carefully before you install the product, connect the wires, or operate the product. Make sure that you fully understand all instructions before you start work. If you are not sure what the instructions mean, contact the seller or the manufacturer.

Follow all instructions in this user guide carefully. Always obey the applicable local rules and regulations.

The original instructions were written in English. If there are differences between the English instructions and the translations, refer to the English instructions.

If you find a mistake in the English instructions or in the translations, please send the details to the manufacturer.

## 1.2 Intended use

The AVT air velocity transmitters are intended to be used in commercial environments for measuring air velocity and temperature in ventilation ducts. They are compatible with dry air. The AVT air velocity transmitters are not intended to be used with flammable or corrosive gases.

These transmitters are intended to be connected to building automation systems in the HVAC/R industry.

## 2 Safety precautions

The product is developed, manufactured and tested according to high quality standards. However, instructions for safe use must be followed when installing, using or disposing the product or parts of product.

Read this user guide carefully before you commission, use or service this device. To avoid any kind of damage to people or property, follow the instructions carefully. Produal is not liable for any hazards, injury to people, or damage to property caused by incorrect installation or misuse of the device.

To avoid electrical shock or damage to equipment, disconnect power before you install or service the product. Use only proper wiring that is rated for the full operating voltage and maximum current in the system. The wiring must also withstand fault conditions.





To avoid fire and/or explosion, do not use the product in potentially flammable or explosive atmosphere.

Make sure that the product is not damaged before installation. Do not drop the product or use excessive force during installation. Do not use the product if you can see any damages.

After installation, the product will be part of a system whose specifications and performance characteristics are not designed or controlled by Produal. Refer to national and local authorities to ensure that the installation is functional and safe.

The product should only be used in professionally designed applications. Unauthorised modifications are not allowed. The product must not be used in relation with any equipment that in case of a failure may threaten, directly or indirectly, human health or life or result in danger to human beings, animals or property.

In this document, there are different warnings and notes. The warning and note types are defined in the following table.

Sign	Description
 <b>WARNING:</b>	The warning symbol indicates a potentially hazardous situation which, if not avoided, could result in death or serious injury.
 <b>CAUTION:</b>	The caution symbol indicates a potentially hazardous situation which, if not avoided, could result in minor or moderate injury.
 <b>Important:</b>	The important symbol indicates a potentially hazardous situation which, if not avoided, could result in damage to the device or property.
 <b>Note:</b>	The note symbol indicates a useful tip or a recommended way to complete a task. These notes also provide information that is useful but not critical to the user.

### 3 Main components

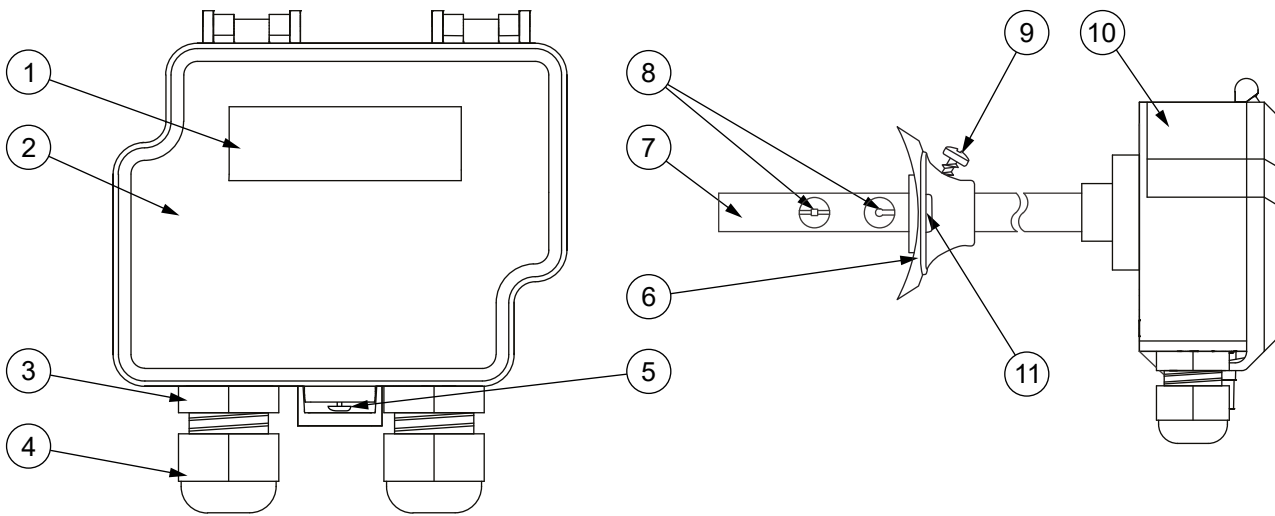

1	Display (-D models)	2	Cover
3	Cable gland	4	Strain relief
5	Cover locking screw (-R models)	6	Duct flange
7	Probe	8	Sensor element
9	Probe locking screw	10	Housing
11	Holes for fixing screws		

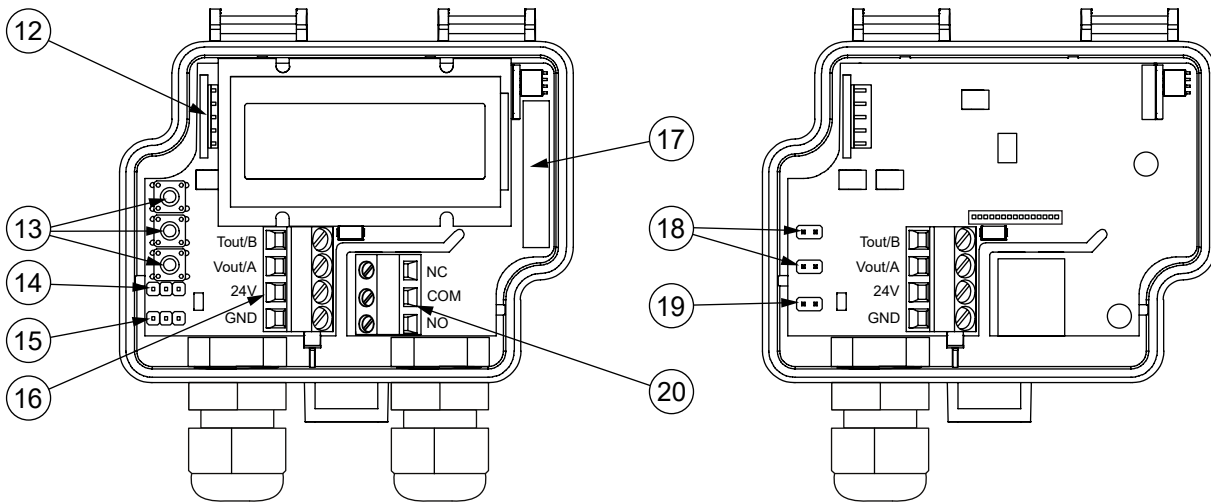

12	Connector for MyTool® Connect dongle (-BT models)	13	Menu buttons (-D models)
14	Jumper for temperature output signal selection (excluding -MOD models)	15	Jumper for air velocity output signal selection (excluding -MOD models)
16	Terminal block	17	Relay (-R models)
18	Measurement range selection jumpers (excluding -D models)	19	Modbus termination jumper (-MOD models)
20	Relay connector (-R models)		

## 4 Commissioning

### 4.1 Setting the jumpers

**Note:** Set the jumpers in the correct position before you connect the supply voltage to the device.

#### 4.1.1 Selecting the measurement range

There are different methods for selecting the measurement range. The method used depends on the device options:

- Devices that do not have a display or Proidual MyTool®: Select the measurement range by installing jumpers as shown in the table below.
- Models with display (-D): Select the output signal mode with jumpers and then the measurement range via the device menu. See section [Selecting the output mode](#) on page 6
- Proidual MyTool® models (-BT): Configure the measurement range settings using MyTool® Connect dongle and the smartphone application. See section [Velocity measurement settings](#) on page 21
- Models with display and Proidual MyTool® (-BT-D): You can configure the measurement range settings in the device menu using the menu buttons on the device or using the MyTool® Connect dongle and the smartphone application. Note that the new settings always replace the existing settings whether you use Proidual MyTool® application or the menu buttons.

#### Selecting the measurement range with jumpers

Install the jumpers according to the table below to select the measurement range for devices that do not have a display and cannot be configured using the MyTool® Connect dongle and smartphone application.

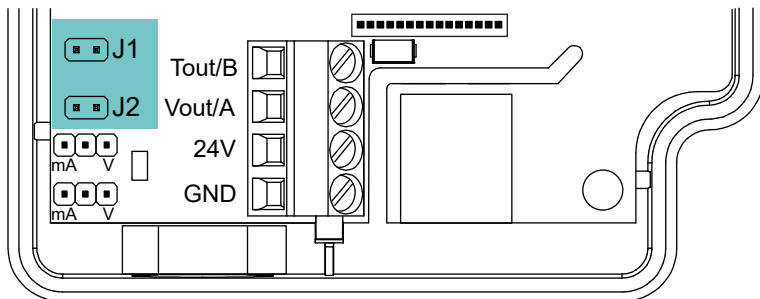

	0...2 m/s	*0...10 m/s	0...20 m/s
J1	■	● ●	■
J2	● ●	■	■
* factory setting			





#### 4.1.2 Selecting the output mode

Select the output signal mode for -MOD models via Modbus communication.

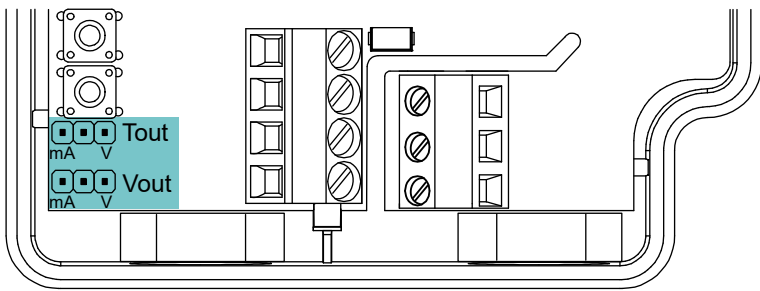
Models with analogue outputs have two jumpers for output signal mode selection on the circuit board. Select the voltage (0...10 V) or the current (4...20 mA) output signal mode based on the system requirements. The current output is not scalable. The voltage output is scalable.

You can configure the output signal separately for air velocity and temperature. Set the jumpers in the correct position to select the output signal mode (V/mA) for air velocity and temperature.



Output					
Temperature output	Tout	Output signal mode: current (mA)	*Output signal mode: voltage (V)	Output signal mode: current (mA)	Output signal mode: voltage (V)
Air velocity output	Vout	Output signal mode: current (mA)	*Output signal mode: voltage (V)	Output signal mode: voltage (V)	Output signal mode: current (mA)
* factory setting					

### 4.1.3 Terminating Modbus (-MOD models)

Insert the termination jumper in the last device of the network to terminate the Modbus network.

1. Disconnect the device supply voltage.
2. Open the cover.
3. Insert the termination jumper in position.

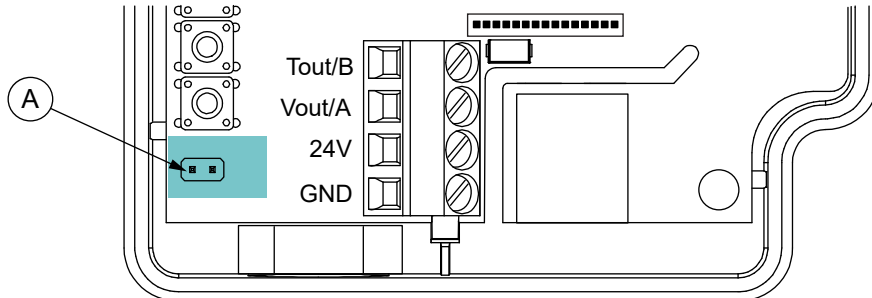

A. Termination jumper

4. Close the cover.

## 4.2 Mounting the product



**WARNING:** Handle the product with care. Dropping the product may cause internal damage and unwanted functions in the connected system.



**CAUTION:** Place the product outside the reach of children and animals.



**Important:** The product may only be installed in a location where the ambient conditions meet the operating condition requirements.



**Note:** Remove the device from the ventilation duct before cleaning the duct.

Operating conditions

Temperature	-25...50 °C (probe) 0...50 °C (transmitter housing)
Humidity	0...95 %rH (non-condensing)

1. Check that the product is not damaged during transportation.
2. Select the mounting position on a straight duct.  
Measure the length of the straight duct to make sure that the probe is positioned correctly. See the figure below for the required minimum length of straight duct.

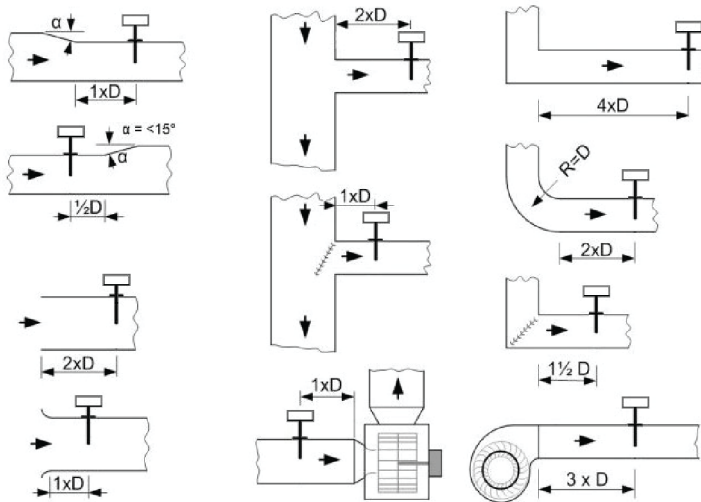

- Round ducts:
    - $D$  = duct diameter
  - Rectangular ducts:
    - If there is a horizontal curve or a change in the duct size:  $D$  = width of the duct
    - If there is a vertical curve or a change in the duct size:  $D$  = height of the duct
3. Use the duct flange as a template and mark the screw holes and the probe hole on the duct.
  4. Drill the screw holes and the probe hole on the duct.  
The maximum screw diameter is 4 mm. The probe diameter is 10 mm.
  5. Mount the duct flange on the duct with screws.

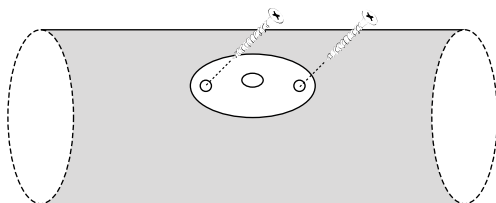

- Push the transmitter probe into the duct through the hole on the flange.  
Make sure that the cable glands of the transmitter point down. See the figure below for the correct mounting orientation.

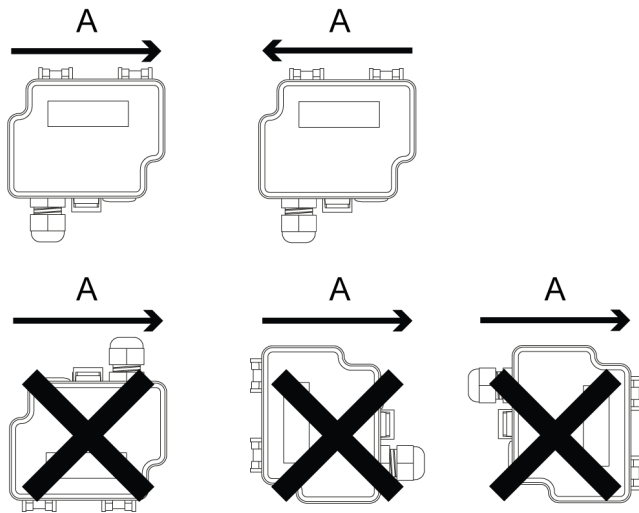

A. Air flow direction



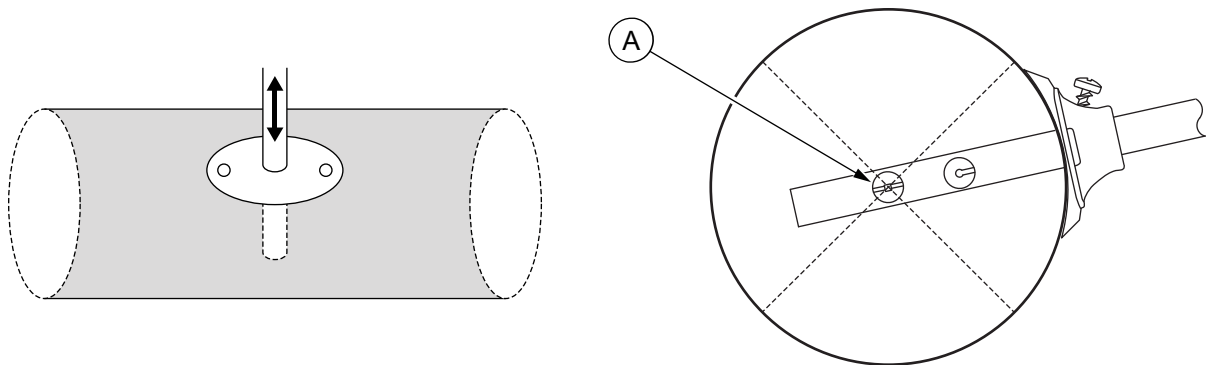



- Adjust the probe to the correct depth.  
Make sure that the air velocity sensor is in the middle of the duct.



A. Air velocity sensor

- Tighten the locking screw on the duct flange to hold the probe in position.

### 4.3 Wiring

-  **WARNING:** Device wiring and commissioning can only be carried out by qualified professionals. Always make the device wirings in de-energised electricity network.
-  **WARNING:** Fuse at load supply (normally 6 A, 10 A, 16 A) does not always limit the relay output load current to 6 A. The relay maximum load is 250 Vac, 6 A res.
-  **WARNING:** Add an external fuse to relay common connector. Use a time-lag fuse (max 6 A) that is in accordance with the standard IEC 60127-2. The product does not have an internal fuse for the relays.
-  **CAUTION:** The product may only be connected to overvoltage category II electricity network according to IEC 60664-1.
-  **CAUTION:** Use single stranded wires or use wire end sleeves if multi stranded wires are used.
-  **Important:** For CE and UKCA compliance, a properly grounded shielding cable is required.

The relay models (-R) and the Modbus (-MOD) models have two cable glands (the left and the right cable gland). Other models only have one cable gland (the left cable gland). See section [Wiring for Modbus models \(-MOD\)](#) on page 10 for Modbus model wiring instructions.

1. Open the cover.



**WARNING:** Do not open the device cover when the relay mains supply voltage is connected. Always do the commissioning of the device in de-energised relay electricity network.

2. Unscrew the strain relief on the left cable gland and route the cables for power in and signal out through the cable gland.
3. For relay models (-R), unscrew the strain relief on the right cable gland and route the cable for the relay through the cable gland.
4. Connect the wires according to the table below.

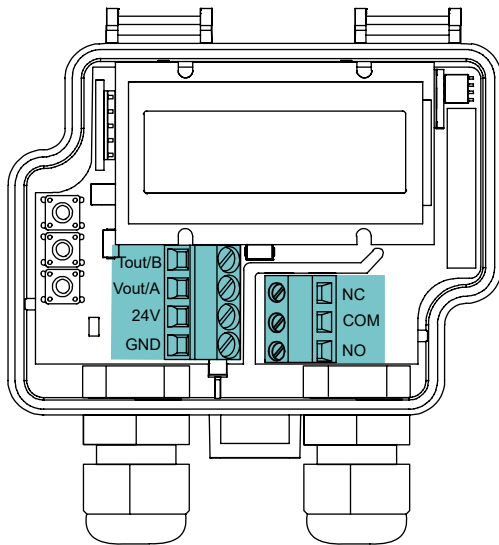

Tout/ B	Temperature measurement output signal: 0...10 Vdc, load > 1 kΩ 4...20 mA, load 20...400 Ω
Vout/ A	Air velocity measurement output signal: 0...10 Vdc, load > 1 kΩ 4...20 mA, load 20...400 Ω
24V	24 Vac/dc supply
GND	0 V
NC	Relay output on -R models: 30 Vdc, 6 A / 230 Vac, 6 A res.
COM	
NO	

The nominal wiring terminal screw tightening torque is 0.4 Nm.



**Important:** Do not use excessive force when you tighten the wiring terminal screws.

5. Tighten the strain reliefs.

### 4.3.1 Wiring for Modbus models (-MOD)



**Note:** The -MOD models have Modbus communication instead of analogue outputs.

**!** **Important:** For CE and UKCA compliance, a properly grounded shielding cable is required.

It is recommended to use shielded twisted pair cable for Modbus cabling. The cable shield must be earthed only in one point, usually at the end of the main cable.

1. Open the cover.
2. Unscrew the strain relief on the left cable gland.
3. Route the cables for power in and Modbus communication through the left cable gland.
4. To connect this device to the next device in a daisy chain network:
  - a. Unscrew the strain relief on the right cable gland.
  - b. Route the Modbus cable to the next device through the right cable gland.
5. Connect the wires according to the table below.

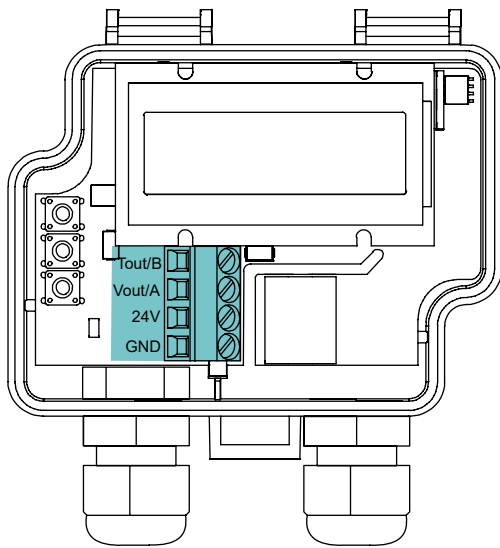

Tout/ B	Modbus RTU (RS-485)
Vout/ A	
24V	24 Vac/dc supply
GND	0 V

The nominal wire terminal screw tightening torque is 0.4 Nm.

**!** **Important:** Do not use excessive force when you tighten the wiring terminal screws.

6. Tighten the strain reliefs.

## 4.4 Warm-up mode

This device starts up in warm-up mode. The warm-up mode continues for 15 seconds after startup. During the warm-up time, the output signals are at the defined minimum values and the relay does not operate. If the device has a display, text *Warming up* is shown on the display. The device starts to operate correctly after the warm-up time.

## 4.5 Configuring settings via device menu

See the figure below for the full menu structure for all models with display (-D) excluding the Modbus models (-MOD). For Modbus model menu structure, see section [Available settings for Modbus](#) on page 16.

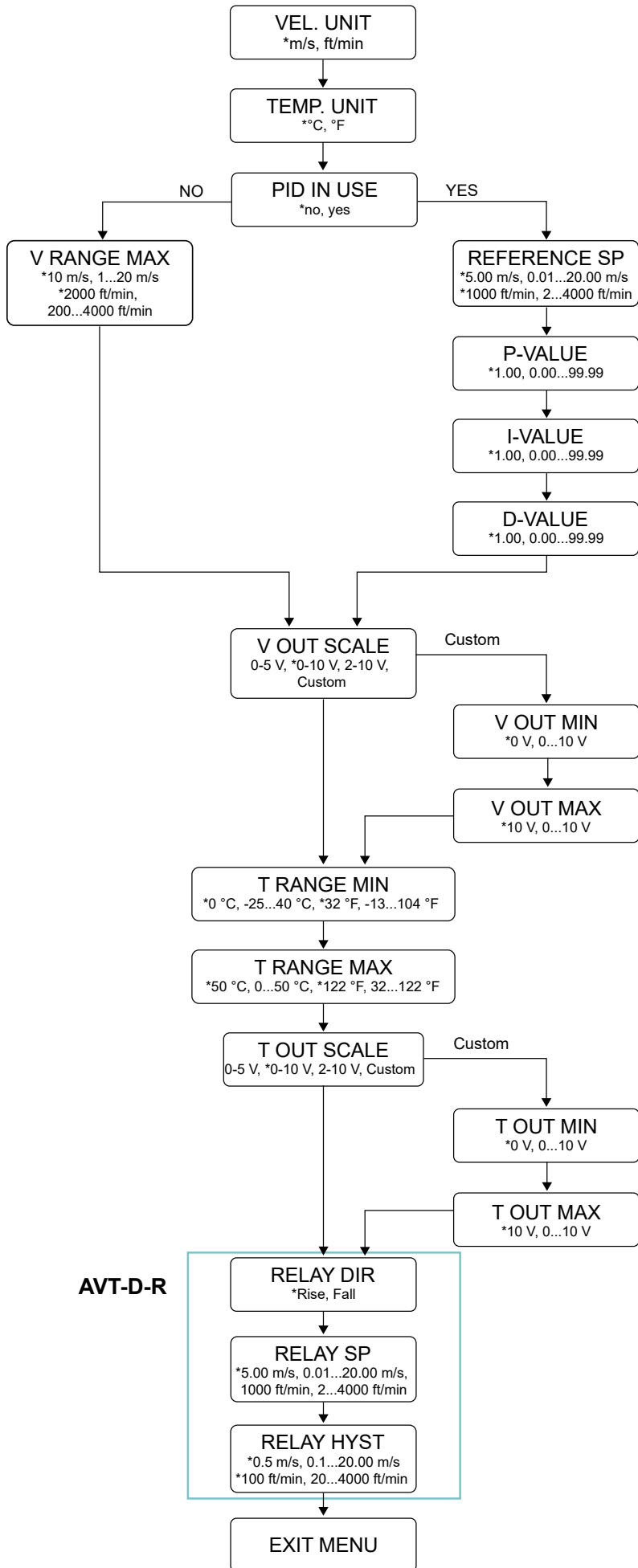

**AVT-D-R**

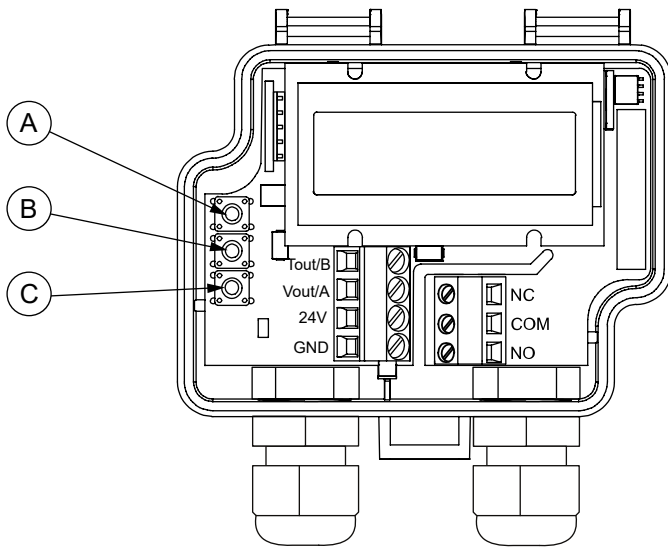

- A. *SELECT* button
- B. *UP* button
- C. *DOWN* button

1. Open the cover.



**WARNING:** Do not open the device cover when the relay mains supply voltage is connected. Always do the commissioning of the device in de-energised relay electricity network.



**CAUTION:** When the power supply is connected, be extra careful when handling the product without the cover.

2. Press the *SELECT* button for two seconds to activate the device menu.
3. Use the *UP* and *DOWN* buttons to navigate the menu.
4. Press the *SELECT* button to change the value of a menu item.
5. Press the *UP* or *DOWN* button to select a value.
6. Press the *SELECT* button to accept the new value and to return to menu navigation.
7. Navigate to the *EXIT MENU* view and press the *SELECT* button to save the settings and exit the menu.

## 4.5.1 Available settings for velocity and temperature

For Modbus model settings, see chapter [Available settings for Modbus](#) on page 16.

### 4.5.1.1 The Vel. unit menu

You can select the velocity unit for the device display and the velocity output in the *VEL. UNIT* menu. The available velocity units are *m/s* and *ft/min*. The default value is *m/s*.

### 4.5.1.2 The Temp. unit menu

You can select the temperature unit for the device display and the temperature output in the *TEMP. UNIT* menu.

The available temperature units are °C and °F. The default value is °C.

### 4.5.1.3 The PID in use menu

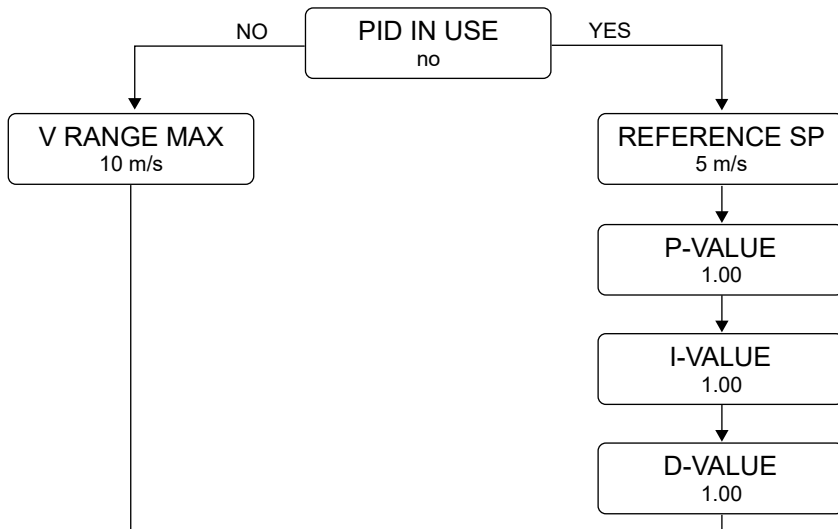

You can select if the PID control function is in use in the *PID IN USE* menu.

The available values are *no* and *yes*. The default value is *no*.

If you select *no*, the next menu item is *V RANGE MAX*.

If you select *yes*, the next menu items are *REFERENCE SP*, *P-VALUE*, *I-VALUE* and *D-VALUE*.

#### The V range max menu

You can select the maximum value for air velocity measurement range in the *V RANGE MAX* menu.

You can select the maximum velocity measurement range between 1 m/s and 20 m/s. The default value is 10 m/s.

If you selected *ft/min* in the *VEL. UNIT* menu, you can select the maximum velocity measurement range between 200 ft/min and 4000 ft/min. You can adjust the value by 200 ft/min steps. The default value is 2000 ft/min.

#### The Reference SP menu

You can select the setpoint for the PID controller in the *REFERENCE SP* menu. You can adjust the value by 0.1 m/s or 1 ft/min steps depending on the selected air velocity unit. The default value is 5 m/s or 1000 ft/min.

#### The P-value, I-value and D-value menus

You can select the proportional gain in the *P-value* menu. You can adjust the value by 0.01 unit steps. The default value is 1.00.

You can select the integral gain in the *I-value* menu. You can adjust the value by 0.01 unit steps. The default value is 1.00.

You can select the derivative gain in the *D-value* menu. You can adjust the value by 0.01 unit steps. The default value is 1.00.

You can select the *P-value*, *I-value* and *D-value* between 0 and 99.99.

### 4.5.1.4 The V out scale menu

You can select the air velocity output scale in the *V OUT SCALE* menu.

The available values are 0-5 V, 0-10 V, 2-10 V and *custom*. The default value is 0-10 V.

If you select *custom*, you can set the minimum and maximum values for the air velocity output scale.

### The V out min menu

If you selected *custom* in the *V OUT SCALE* menu, you can select the minimum value for the air velocity output scale in the *V OUT MIN* menu.

You can select a value between 0 V and 10 V. You can adjust the value by 1 V steps. The default value is 0 V.



**Note:** You can select a minimum value that is bigger than the maximum value to reverse the operating direction.

### The V out max menu

If you selected *custom* in the *V OUT SCALE* menu, you can select the maximum value for the air velocity output scale in the *V OUT MAX* menu.

You can select a value between 0 V and 10 V. You can adjust the value by 1 V steps. The default value is 10 V.



**Note:** You can select a maximum value that is smaller than the minimum value to reverse the operating direction.

### 4.5.1.5 The T range min menu

You can select the minimum value for temperature measurement range in the *T RANGE MIN* menu.

You can select a value between -25 °C and 40 °C. You can adjust the value by 5 °C steps. The default value is 0 °C.

If you selected °F in the *TEMP. UNIT* menu, you can select a value between -13 °F and 104 °F. You can adjust the value by 2 °F steps. The default value is 32 °F.

### 4.5.1.6 The T range max menu

You can select the maximum value for temperature measurement range in the *T RANGE MAX* menu.

You can select a value between -15 °C and 50 °C. You can adjust the value by 5 °C steps. The default value is 50 °C.

If you selected °F in the *TEMP. UNIT* menu, you can select a value between 5 °F and 122 °F. You can adjust the value by 2 °F steps. The default value is 122 °F.

### 4.5.1.7 The T out scale menu

You can select the temperature output scale in the *T OUT SCALE* menu.

The available values are 0-5 V, 0-10 V, 2-10 V and *custom*. The default value is 0-10 V.

If you select *custom*, you can set the minimum and maximum values for the temperature output scale.

#### The T out min menu

If you selected *custom* in the *T OUT SCALE* menu, you can select the minimum value for the temperature output scale in the *T OUT MIN* menu.

You can select a value between 0 V and 10 V. You can adjust the value by 1 V steps. The default value is 0 V.



**Note:** You can select a minimum value that is bigger than the maximum value to reverse the operating direction.

#### The T out max menu

If you selected *custom* in the *T OUT SCALE* menu, you can select the maximum value for the temperature output scale in the *T OUT MAX* menu.

You can select a value between 0 V and 10 V. You can adjust the value by 1 V steps. The default value is 10 V.



**Note:** You can select a maximum value that is smaller than the minimum value to reverse the operating direction.

## 4.5.2 Relay settings

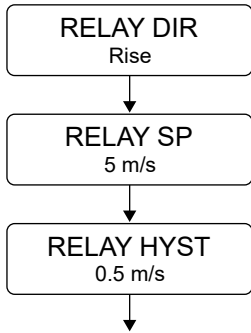

### 4.5.2.1 The Relay dir menu

This menu is shown only if the transmitter has a relay output (-R models). Relay operating direction defines if the relay switches on or off when the air velocity is more than the setpoint value.

You can select the relay operating direction in the *RELAY DIR* menu. The available values are *Rise* and *Fall*. The relay switches on if *Rise* is selected and the air velocity is more than the setpoint value. If *Fall* is selected, the relay switches on when the air velocity is less than the setpoint value. The default value is *Rise*.

### 4.5.2.2 The Relay SP menu

This menu is shown only if the transmitter has a relay output (-R models).

You can set the velocity setpoint for the relay in the *RELAY SP* menu. You can set this value with an accuracy of two decimals. The default value is 5 m/s or 1000 ft/min.

### 4.5.2.3 The Relay hyst menu

This menu is shown only if the transmitter has a relay output (-R models). This setting defines how much the air velocity must drop below the setpoint before the relay switches off if *Rise* is selected in the *RELAY DIR* menu. The function is opposite if *Fall* is selected in the *RELAY DIR* menu.

You can set the hysteresis value for the relay in the *RELAY HYST* menu. You can select a value between 0.1 and 20.0 m/s. You can adjust the value by 0.1 m/s steps. The default value is 0.5 m/s.

If you selected *ft/min* in the *VEL. UNIT* menu, you can select a value between 20 ft/min and 4000 ft/min. You can adjust the value by 20 ft/min steps. The default value is 100 ft/min.

## 4.5.3 The Exit menu view

Navigate to the *EXIT MENU* view and press the *SELECT* button to save the settings and exit the menu.

## 4.5.4 Available settings for Modbus

The figure below shows the menu structure for the Modbus models with display (-MOD-D). These menu settings are only available in the Modbus models.

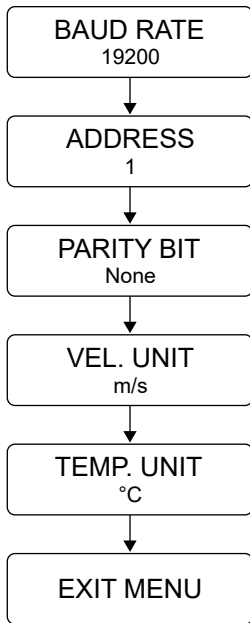

#### 4.5.4.1 The Baud rate menu

You can select the bus speed in the *BAUD RATE* menu.

The bus speed can be 9600, 19200 or 38400 bits/s. The default baud rate is 19200 bits/s.

#### 4.5.4.2 The Address menu

You can select the Modbus address in the *ADDRESS* menu.

Address range is 1...247. The default value is 1.

#### 4.5.4.3 The Parity bit menu

You can select Modbus parity in the *PARITY BIT* menu.

The available values for bus parity are *none*, *odd* and *even*. The default setting is *none*.

#### 4.5.4.4 The Vel. unit menu

You can select the velocity unit for the device display and the velocity output in the *VEL. UNIT* menu.

The available velocity units are *m/s* and *ft/min*. The default value is *m/s*.

#### 4.5.4.5 The Temp. unit menu

You can select the temperature unit for the device display and the temperature output in the *TEMP. UNIT* menu.

The available temperature units are °C and °F. The default value is °C.

#### 4.5.4.6 The Exit menu view

Navigate to the *EXIT MENU* view and press the *SELECT* button to save the settings and exit the menu.

### 4.6 Configuring settings using Produal MyTool® application

You can configure the settings of the -BT models with Produal MyTool® application installed in your smartphone. To configure the device, you first need to connect it to the Produal MyTool® application. When the device is connected to the application, you can make changes to the configuration.



**Note:** You need a MyTool® Connect dongle for connecting Produal MyTool® to the device.

**Note:** Exit the device menu before you start to configure the device with the Produal MyTool® application.

1. If the device has a relay (-R models), disconnect the relay mains supply voltage.

**WARNING:** Do not open the device cover when the relay mains supply voltage is connected. Always do the commissioning of the device in de-energised relay electricity network.

2. Open the device cover.
3. Insert the MyTool® Connect dongle into the connector on the device circuit board.  
Make sure that the Produal logo on the dongle points right.

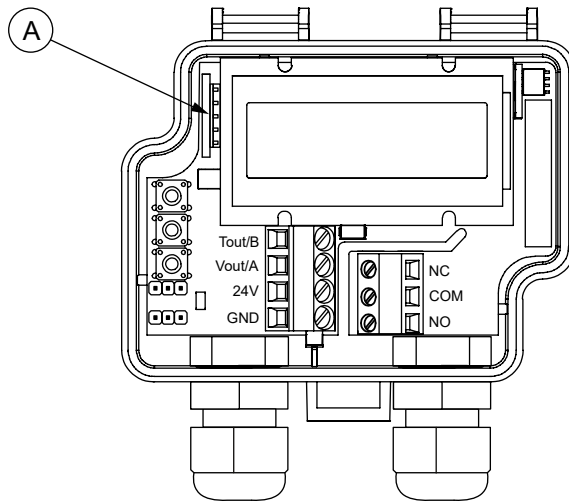

A. Connector for MyTool® Connect dongle

**Note:** You can also power the device by connecting a USB cable to the MyTool® Connect dongle.

The indicator light in the MyTool® Connect dongle flashes when the device is ready to connect to a smartphone.

4. Start the Produal MyTool® application.
5. Tap the *Bluetooth Devices* button.

The device list shows the devices that have Bluetooth activated.

6. Tap a device on the list to select it.

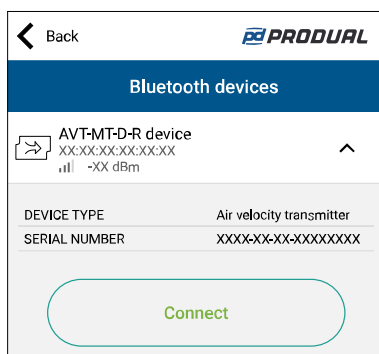

7. Tap the *Connect* button.

The indicator light in the MyTool® Connect dongle is on continuously when the device is connected to the Produal MyTool® application.

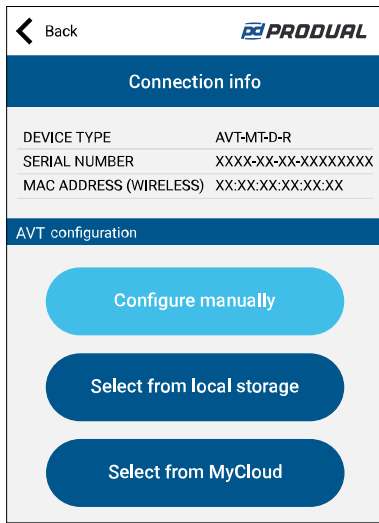

8. Tap the *Configure manually* button.

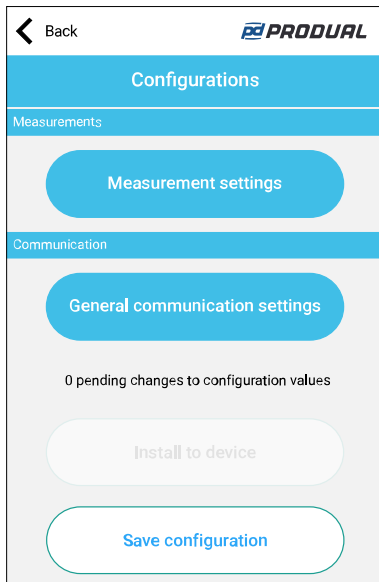

The **Configurations** page has the following menus:

- Measurement settings* Set up air velocity and temperature measurement settings.
- General communication settings* Set up communication parameters.

9. Make the changes to the configuration.

See sections [Configuring measurement settings](#) on page 20 and [Configuring communication settings](#) on page 22 for detailed instructions.

- When you have made the necessary changes, tap the *Install to device* button on the **Configurations** page to upload and save the changes to the device.

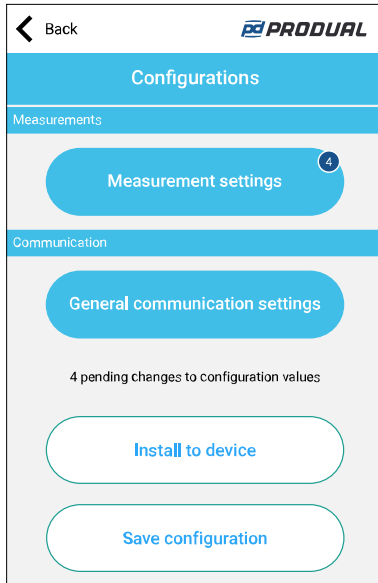

- Tap the *Back* button to return to the **Connection info** page.
- Tap the *Disconnect* button to disconnect the device.
- Remove the MyTool® Connect dongle from the device.

### 4.6.1 Configuring measurement settings

On the **Measurement settings** page, you can configure the settings for air velocity measurement and temperature measurement.

- Tap the *Measurement settings* button on the **Configurations** page to open the **Measurement settings** page.

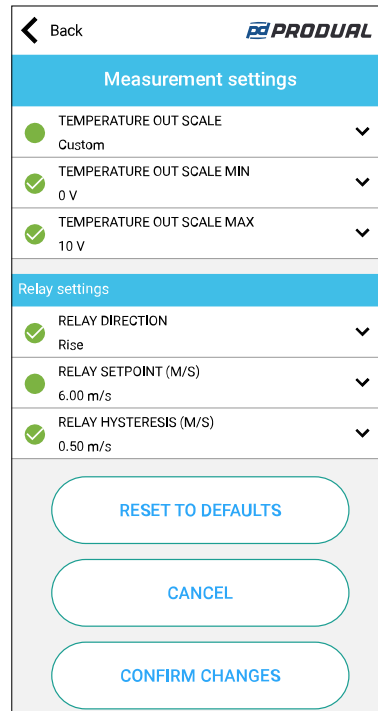
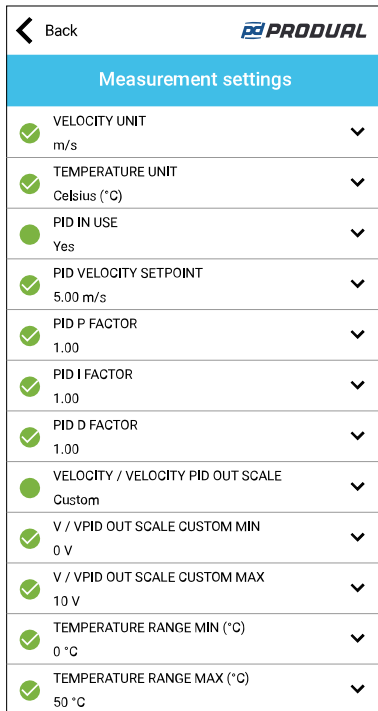

- Tap a parameter to open the settings for that parameter.
- Configure the settings.

See sections [Velocity measurement settings](#) on page 21 and [Temperature measurement settings](#) on page 21 below for the available settings.

4. Scroll to the bottom of the page.
5. Tap the *Confirm changes* button to save the changes to the application.
6. On the **Configurations** page, tap the *Install to device* button to upload and save the changes to the device.

#### 4.6.1.1 Velocity measurement settings

Parameter name	Values	Default	Description
Velocity unit	m/s ft/min	m/s	Velocity unit for the device display and the velocity output.
PID in use	No / Yes	No	Disable/enable PID.
PID velocity setpoint	0.01...20.00 m/s 2...4000 ft/min	5.00 m/s 1000 ft/min	Air velocity setpoint for the PID controller. Shown if the value of the <i>PID in use</i> parameter is Yes.
PID P factor	0.00...99.99	1.00	Value for proportional gain. Shown if the value of the <i>PID in use</i> parameter is Yes.
PID I factor	0.00...99.99	1.00	Value for integral gain. Shown if the value of the <i>PID in use</i> parameter is Yes.
PID D factor	0.00...99.99	1.00	Value for derivative gain. Shown if the value of the <i>PID in use</i> parameter is Yes.
Velocity range max	1...20 m/s 200...4000 ft/min	10 m/s 2000 ft/min	The maximum value for air velocity measurement range
Velocity / Velocity PID out scale	0-5 V / 0-10 V / 2-10 V / Custom	0-10 V	Scale for the air velocity output signal and the velocity control output signal. If you select <i>Custom</i> , you can set the minimum and maximum values.
V / VPID out scale custom min	0...10 V	0 V	Minimum value for the air velocity output signal scale and the velocity control output signal scale. Shown if the value of <i>Velocity / Velocity PID out scale</i> parameter is <i>Custom</i> .
V / VPID out scale custom max	0...10 V	10 V	Maximum value for the air velocity output signal scale and the velocity control output signal scale. Shown if the value of <i>Velocity / Velocity PID out scale</i> parameter is <i>Custom</i> .

#### 4.6.1.2 Temperature measurement settings

Parameter name	Values	Default	Description
Temperature unit	Celsius (°C) / Fahrenheit (°F)	Celsius (°C)	Temperature unit for the device display and the temperature output.
Temperature range min	-25...40 °C -13...104 °F	0 °C 32 °F	The minimum value for temperature measurement range.
Temperature range max	0...50 °C 32...122 °F	50 °C 122 °F	The maximum value for temperature measurement range.
Temperature out scale	0-5 V / 0-10 V / 2-10 V / Custom	0-10 V	Temperature measurement output scale. If you select <i>Custom</i> , you can set the minimum and maximum values for the temperature output scale.

Parameter name	Values	Default	Description
Temperature out scale min	0...10 V	0 V	Minimum value for the temperature output scale. Shown if the value of the <i>Temperature out scale</i> parameter is <i>Custom</i> .
Temperature out scale max	0...10 V	10 V	Maximum value for the temperature output scale. Shown if the value of the <i>Temperature out scale</i> parameter is <i>Custom</i> .

### 4.6.1.3 Relay settings

Relay settings section is shown on the **Measurement settings** page only if the transmitter has a relay output (-R models).

Parameter name	Values	Default	Description
Relay direction	Rise / Fall	Rise	Relay operating direction defines if the relay switches on or off when the air velocity is more than the setpoint value. The relay switches on if <i>Rise</i> is selected and the air velocity is more than the setpoint value. If <i>Fall</i> is selected, the relay switches on when the air velocity is less than the setpoint value.
Relay setpoint	0.01...20.00 m/s 2...4000 ft/min	5.00 m/s 1000 ft/min	Air velocity setpoint for the relay.
Relay hysteresis	0.01...20.00 m/s 2...4000 ft/min	0.50 m/s 100 ft/min	Relay hysteresis defines how much the air velocity must drop below the setpoint before the relay switches off if <i>Rise</i> is selected for the <i>Relay direction</i> parameter. The function is opposite if <i>Fall</i> is selected.

### 4.6.2 Configuring communication settings

On this settings page, you can rename the device.

1. Tap the *General communication settings* button on the **Configurations** page to open the **Communication parameters** page.

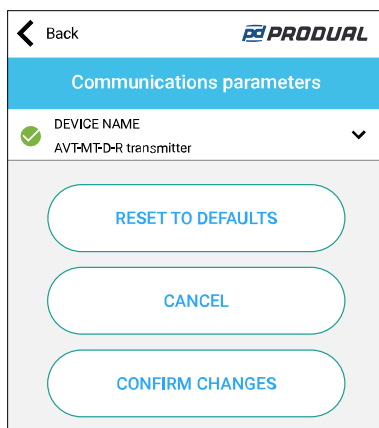

2. Tap the *Device name* field to rename the device.
3. Enter the new name in the field.
4. Tap the *Confirm changes* button to save the changes to the application.
5. On the **Configurations** page, tap the *Install to device* button to upload and save the changes to the device.

Parameter name	Values	Default	Description
Device name	0...32 characters	Unnamed device	Device name. Device name supports ASCII characters. This name is shown on the <b>Bluetooth devices</b> page.

### 4.6.3 Saving and loading the configuration

If you have several devices to configure, you can save the configuration and then load it for the next device.

1. After you have configured the settings, tap the *Save configuration* button on the **Configurations** page.

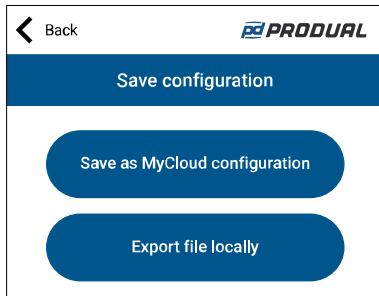

2. On the **Save configuration** page, select *Save as MyCloud configuration* to save the configuration to ProDual MyCloud® service or *Export file locally* to save the configuration to your smartphone or other mobile device you are currently using.
3. Tap the *Configuration name* field and enter a name for the configuration.
4. Tap the *Save* button to save the configuration.
5. Tap the *Install to device* button to save the changes to the device if there are pending changes.
6. Tap the *Back* button to return to the **Connection info** page.
7. Tap the *Disconnect* button to disconnect the device.
8. Remove the MyTool® Connect dongle from the device.
9. Insert the MyTool® Connect dongle into the next device and connect it to the ProDual MyTool® application.
10. On the **Connection info** page, tap the *Select from local storage* button if you saved the configuration to your smartphone or the *Select from MyCloud* button if you saved the configuration to the cloud.

11. Tap the configuration file to select it.

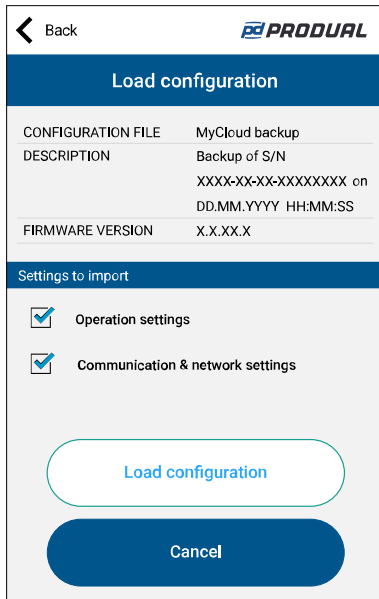

12. Select the settings you want to import.

13. Tap the **Load configuration** button to load the configuration.

You can make changes to the loaded configuration, if necessary.

14. When you have made the necessary changes, tap the *Install to device* button on the **Configurations** page to upload and save the changes to the device.

#### 4.6.4 Resetting device settings to defaults

Do the steps below to reset the device settings to the default values.

1. Tap the *Measurement settings* button on the **Configurations** page to open the **Measurement settings** page.
2. Scroll to the bottom of the page.
3. Tap the *Reset to defaults* button.
4. Tap the *Confirm changes* button to save the changes to the application.
5. On the **Configurations** page, tap the *Install to device* button to upload and save the changes to the device.

### 4.7 Locking the cover

**WARNING:** There is a hazardous voltage inside the R-model devices. Always lock the cover before the relay mains supply voltage is connected.

1. Close the cover.
2. Tighten the cover locking screw (-R models).

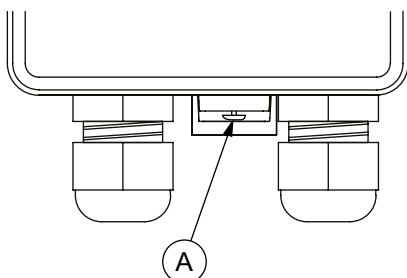

A. Cover locking screw

- 
3. Make sure that the cover does not open without tools.

## 5 Maintenance

### 5.1 Cleaning the probe and the sensor element

Dust, grease and other dirt can accumulate on the sensor element over time and decrease the measurement accuracy of the sensors. Clean the probe and the sensor element regularly. The required cleaning interval depends on the air cleanliness.

Do not clean the sensor element with detergents or other chemicals.

1. Disconnect the device supply voltage. For the -R models, disconnect the device supply voltage and the relay mains supply voltage.
2. Clean the probe with a soft cloth.

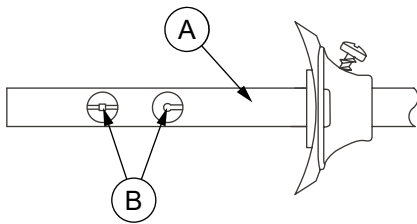

- A. Probe
- B. Sensor element

3. Clean the sensor element with compressed air.

Apply compressed air lightly to the sensor element to prevent damage.

**!** **Important:** Do not use too high pressure, touch the sensor element or use other cleaning methods that cause mechanical stress. Mechanical stress damages the sensor element and changes the measurement accuracy of the sensors.

## 6 Modbus

### 6.1 Modbus properties

The Modbus communication is only available in -MOD models.

The parameter memory durability allows at least 1 000 writing cycles.



**Note:** The changes to the Modbus communication settings take effect after you restart the device.

Protocol	RS-485 Modbus RTU
Bus speed	9600/*19200/38400 bit/s
Data bits	8
Parity	*none/odd/even
Stop bits	1
Modbus ID	1*
Unit load	1/8 UL
	* factory setting

### 6.2 Modbus function codes

The device supports the following Modbus function codes.

Decimal	Hexadecimal	Function
3	0x03	Read Holding Registers
4	0x04	Read Input Registers
6	0x06	Write Single Register
16	0x10	Write Multiple Registers

### 6.3 Modbus registers

#### 6.3.1 Input registers

##### General

Register	Parameter description	Data type	Values	Range
0	Velocity m/s	U16	0...2000	0...20 m/s
1	Velocity ft/min	U16	0...4000	0...4000 ft/min
2	Temperature °C	S16	-250...500	-25.0...50.0 °C
3	Temperature °F	S16	-130...1220	-13.0...122.0 °F
4...99	Reserved for future use			

##### Device model details

Register	Parameter description	Data type	Values	Range
9800	Register count	U16	0...99	0...99

Register	Parameter description	Data type	Values	Range
9801	Format version	U16	0...65535	0...65535
9802	Display	U16	0...1	0. no 1. yes
9803	Buttons	U16	0...1	0. no 1. yes
9804	Number of relays	U16	0...1	0...1
9805	Analogue outputs	U16	0...1	0. no 1. yes
9806	Modbus	U16	0...1	0. no 1. yes
9807	Connector for MyTool® Connect	U16	0...1	0. no 1. yes
9808	PID controller	U16	0...1	0. no 1. yes

## Device information

Register	Parameter description	Data type	Values	Range
9900	Device type	U16	0...65535	0...65535
9901	Hardware version	U16	0...65535	0...65535
9902	Production number, most significant word	U16	0...65535	0...65535
9903	Production number, least significant word	U16	0...65535	0...65535
9904	Configuration number, most significant word	U16	0...65535	0...65535
9905	Configuration number, least significant word	U16	0...65535	0...65535
9906...9908	Reserved for Produal MyTool®	U16		
9909	Ethernet MAC address 1	U16	0	0
9910	Ethernet MAC address 2	U16	0	0
9911	Ethernet MAC address 3	U16	0	0
9912	Wireless MAC address 1	U16	0	0
9913	Wireless MAC address 2	U16	0	0
9914	Wireless MAC address 3	U16	0	0

Register	Parameter description	Data type	Values	Range
9915	Memory state	U16	0...9	0. Idle 1. Loading latest configuration 2. Saving latest configuration 3. Loading default configuration 4. Saving default configuration 5. Loading calibration 6. Saving calibration 7. Saving application state 8. Chip erase in progress 9. Cloud configuration management
9916	Configuration compatibility number	U16	0...65535	0...65535
9917	Firmware ID, most significant word	U16	0...65535	0...65535
9918	Firmware ID, least significant word	U16	0...65535	0...65535
9919	Firmware version (major, minor)	U16	0...65535	0...65535
9920	Firmware version (revision, build)	U16	0...65535	0...65535
9921...9923	Reserved for Produal MyTool®	U16	25	25
9924	Produal MyTool® compatibility number	U16	0	0. Compatibility number not assigned (feature is not in use)

## 6.3.2 Holding registers

### Modbus

Register	Parameter description	Data type	Values	Range	Default
0	Bus speed	U16	0...2	0. 9600 1. 19200 2. 38400	1
1	Address	U16	1...247	1...247	1
2	Parity bit	U16	0...2	0. none 1. even 2. odd	0
3	Velocity unit	U16	0...1	0. m/s 1. ft/min	0
4	Temperature unit	U16	0...1	0. Celsius 1. Fahrenheit	0
5...199	Reserved for future use				

## MyTool

Register	Parameter description	Data type	Values	Range	Default
200	PID in use	U16	0...1	0. no 1. yes	0
201	Velocity range max. (m/s)	U16	1...20	1...20 m/s	10
202	Velocity range max. (ft/min)	U16	2...40	200...4000 ft/min	20
203	Velocity control setpoint (m/s)	U16	1...2000	0.01...20 m/s	500
204	Velocity control setpoint (ft/min)	U16	2...4000	2...4000 ft/min	1000
205	Velocity control P factor	U16	0...9999	0...99.99	100
206	Velocity control I factor	U16	0...9999	0...99.99	100
207	Velocity control D factor	U16	0...9999	0...99.99	100
208	Velocity / velocity control signal scale	U16	0...3	0. 0...5 V 1. 0...10 V 2. 2...10 V 3. Custom	1
209	Velocity / velocity control signal scale custom min.	U16	0...10	0...10 V	0
210	Velocity / velocity control signal scale custom max.	U16	0...10	0...10 V	10
211	Temperature range min. (°C)	U16	-25...40	-25...40 °C	0
212	Temperature range min. (°F)	U16	-13...104	-13...104 °F	32
213	Temperature range max. (°C)	U16	-15...50	-15...50 °C	50
214	Temperature range max (°F)	U16	5...122	5...122 °F	122
215	Temperature output signal scale	U16	0...3	0. 0...5 V 1. 0...10 V 2. 2...10 V 3. Custom	1
216	Temperature output signal scale custom min.	U16	0...10	0...10 V	0
217	Temperature output signal scale custom max.	U16	0...10	0...10 V	10
218	Relay operating direction	U16	0...1	0. Rise 1. Fall	0
219	Relay setpoint (m/s)	U16	1...2000	0.01...20 m/s	500
220	Relay setpoint (ft/min)	U16	2...4000	2...4000 ft/min	1000
221	Relay hysteresis (m/s)	U16	1...2000	0.01...20 m/s	50
222	Relay hysteresis (ft/min)	U16	2...4000	2...4000 ft/min	100

## 7 Disposal

This device is considered as electrical and electronic equipment for disposal in terms of the applicable European Directive. At the end of life, the product must enter the recycling system at an appropriate collection point.

- The device must be disposed through channels provided for this purpose.
- The disposal must be completed according to the local and currently applicable laws and regulations.

Generally all metals can be recycled as material. Plastics and cardboard packaging material can be used in energy recovery. Printed circuit boards need selective treatment according to IEC 62635 guidelines. To aid recycling, plastic parts are marked with an appropriate identification code. Contact your local Produal distributor for further information on environmental aspects and recycling instructions for professional recyclers.

